

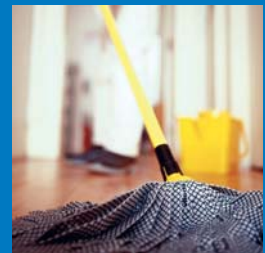

R3 RELIABLE REDISTRIBUTION RESOURCE®



T O T A L S O L U T I O N P R O V I D E R

PRODUCT CATALOG

We've taken a legacy of experience and expertise in redistribution and unified it into one forward thinking organization that delivers the best/most efficient solutions for the redistribution marketplace.

JANITORIAL &
SANITARY SUPPLIES
FOOD SERVICE
PRODUCTS

1 - 8 6 6 - 9 8 7 - R 3 R 3 (7 3 7 3)

FREE UP CASH AND GET NEW GROWTH WITH REDISTRIBUTION

PLUS ORDER ONLY WHAT YOU NEED ONLINE. ANYWHERE.
ONE SOURCE. ONE CONTACT.

Why tie up your capital in inventory and its management, when you can order from us only what you need, when you need it? You'll enjoy faster inventory turnaround times, reduce warehousing, freight and order processing costs.

We'll take care of the logistics and transportation for increased supply chain efficiency. The bottom line is we help you reduce the cost of possession and increase your ROI.



R3 RELIABLE REDISTRIBUTION RESOURCE®

Your Best Source for Food Service, Jan-San, and Green Product Needs.

visit us at www.r3redistribution.com

Table of Contents

GREEN7-40 GS 

CHEMICALS41-100 JS 

SOAPS101-120 JS 

HARD FLOOR CARE121-128 JS 

CARPET CARE129-132 JS 

PAPER PRODUCTS133-164 JS 

APPAREL165-174 JS 

CLEANING TOOLS175-216 JS 

CAN LINERS & CONTAINERS217-240 JS 

FLOOR EQUIPMENT241-244 JS 

BOWLS, PLATES & PLATTERS245-254 FS 

CUPS255-270 FS 

RESTAURANT, BAR & OFFICE SUPPLIES271-292 FS 

NAPKINS, PLACEMATS & TABLE COVERS293-300 FS 

CONTAINERS & TRAYS301-342 FS 

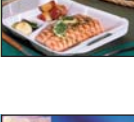
BAGS343-356 FS 

FOODSERVICE WRAPS & PROCESSING ...357-374 FS 

INDEXES375-378 I 

Index	
2	Dye Sheets
126	Dye Carpet
128	Dye Map Frames
28	Dye Map Frames
53	Dye Map Treatment
162	Dye Maps
77	Dye Plans
27	Dishes
23	Dishes, Sauffer
126	Dusting Brush
118-120	

NOTE: Not all products in this catalog may be in stock at our location, but with our logistics network all of them are readily available. Additionally, there are items offered by our sources of supply that are not included in this catalog. They are considered Special Order Items. If you have questions concerning a product not listed in this catalog please contact your Sales Representative. Special Order Items require a longer lead-time than regularly stocked product. Once ordered, Special Order Items are non-cancelable and cannot be returned to us. Lastly, we are not responsible for any errors or omissions in this catalog.



GREEN SOURCE™

Be Green – Save Green

R3® is rolling out its Green Source™ towel, tissue and napkin products.

Our house keeps getting greener!

R3®

Your source for green-certified towel, tissue and napkin products without the additional cost.

- 100% Recycled
- Chlorine-Free
- Trilingual Packaging (English, Spanish & French)



Certified Hand Towels CCD-086
and Toilet Tissue CCD-082



For more information about these Green Source™ products, go to www.r3redistribution.com/green/green-source.asp

R3 REDUCE REUSE RECYCLE



WWW.R3REDISTRIBUTION.COM

HIDDEN COST SAVING OPPORTUNITY

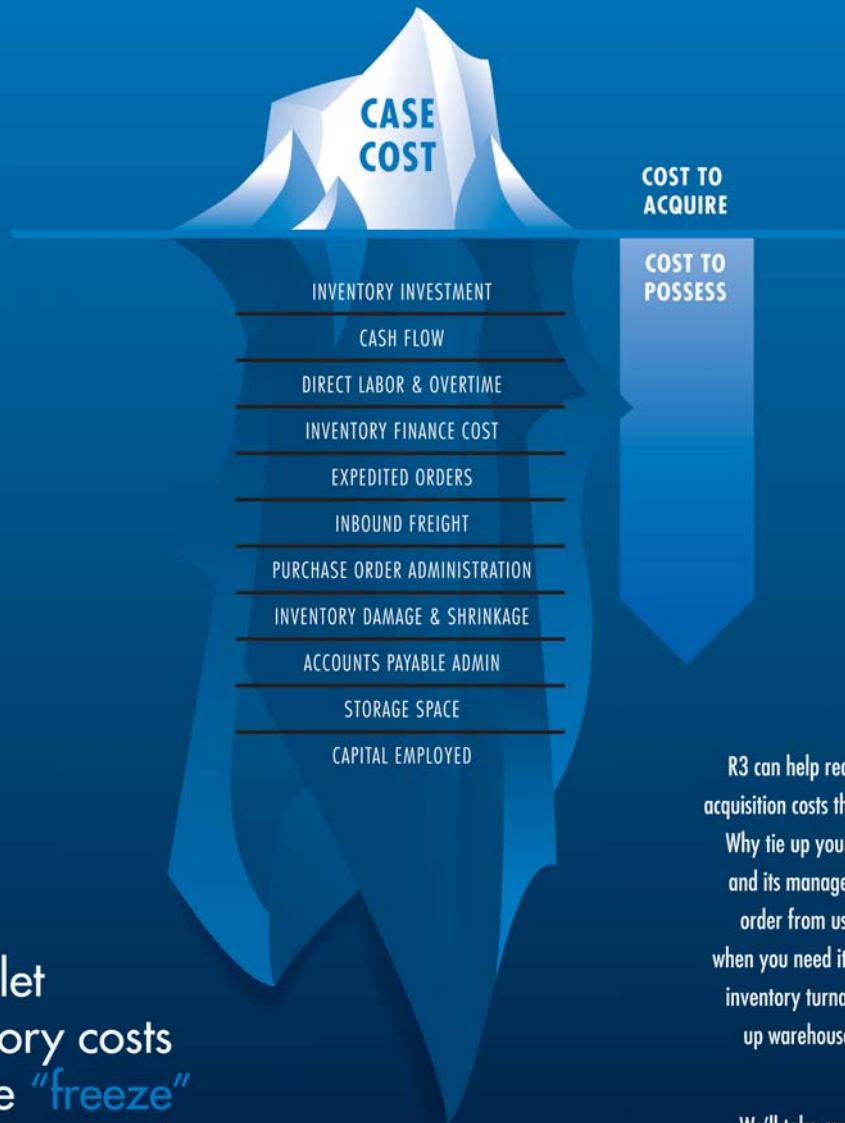

Don't let
inventory costs
put the "freeze"
on your growth.

R3 can help reduce the "iceberg" of acquisition costs that freezes up capital. Why tie up your capital in inventory and its management, when you can order from us only what you need, when you need it? You'll enjoy faster inventory turnaround times, freeing up warehouse space and reducing costly wastage.

We'll take care of the logistics and transportation for you, for increased supply chain efficiency. The bottom line is we help you reduce the cost of possession, to help improve your company's bottom line.

DEPENDABLE. FLEXIBLE. FOCUSED.

www.r3redistribution.com



R3 RELIABLE REDISTRIBUTION RESOURCE®

Paper Dinnerware



PAPER DINNERWARE

A. NATURAL BROWN DINNERWARE

BRIDGE-GATE ALLIANCE GROUP

Compostable serving ware. Molded fiber pulp product with environmentally advanced technologies, conserving energy and water. Starting with the purest raw materials, the natural byproducts of agricultural waste, Bridge-Gate employs a proprietary, self-contained washing and Biopulping process, minimizing ecological impact from field to factory to foodservice. With Bridge-Gate, you and your customers can be assured of compostable, consistently top-quality products that have been produced with the utmost concern for the environment.

B7280008	<i>BGW12B</i>	12 oz. Bowl	8/125/cs.
B7280012	<i>BGW06</i>	6", Plate	8/125/cs.
B7280013	<i>BGW07</i>	7", Plate	8/125/cs.
B7280011	<i>BGW09</i>	9", Plate	4/125/cs.
B7280009	<i>BGW103</i>	10 ¹ / ₄ ", 3-Compt. Plate	4/125/cs.
B7280010	<i>BGW10</i>	10 ¹ / ₂ ", Plate	4/125/cs.
B7280016	<i>BGW710</i>	7" x 10", Platter	4/125/cs.
B7280015	<i>BGW912</i>	9" x 12", Platter	4/125/cs.



B. HARVEST COLLECTION™ DINNERWARE

GENPAK

Compostable dinnerware item for foodservice applications. Produced from environmentally friendly, annually renewable resources. Harvest Wheat color.

34789245	<i>HCD12</i>	12 oz., Bowl	1000/cs.
34789244	<i>HCB24</i>	24 oz., Bowl	200/cs.
34789243	<i>HCB32</i>	32 oz., Bowl	200/cs.
34789241	<i>HCD06</i>	6", Plate	1000/cs.
34789240	<i>HCD09</i>	9", Plate	200/cs.
34789238	<i>HCD10</i>	10 ¹ / ₄ ", Plate	250/cs.
34789239	<i>HCD39</i>	9", 3-Compt. Plate	250/cs.
34789237	<i>HCD13</i>	10 ¹ / ₄ ", 3-Compt. Plate	250/cs.



C. CHINET® CLASSIC WHITE™ MOLDED FIBER DINNERWARE

HUHTAMAKI

Chinet® Classic White™ premium strength paper tableware is recognized everywhere as a quality product you can rely on for superior strength. Made of 99% reclaimed fiber and is microwaveable. 100% recycled/compostable. Passes BPI/ASTM. Made in the USA. Passes Cedar Grove compostable standards.

White

15306315	<i>21225</i>	6", Vacate	1000/cs.
-----------------	--------------	------------	----------

Burgundy & Gray

15304628	<i>22506</i>	4 oz., Bowl, Portal	2000/cs.
15304644	<i>22507</i>	12 oz., Port	1000/cs.
15304603	<i>22501</i>	6", Plate, Pocket	1000/cs.
15304637	<i>22508</i>	6 ³ / ₄ ", Plate, Pole	1000/cs.
15304610	<i>22502</i>	8 ³ / ₄ ", Plate, Point	500/cs.
15304640	<i>22509</i>	9 ³ / ₄ ", Plate, Poodle	500/cs.
15304670	<i>22505</i>	10 ¹ / ₂ ", Plate, Poplar	500/cs.
15304690	<i>22504</i>	7 ¹ / ₂ " x 10", Platter, Pony	500/cs.

Festival Design

15304658	<i>22607</i>	12 oz., Bowl, Pouch	1000/cs.
15304632	<i>22605</i>	10 ¹ / ₂ ", Plate, Porch	500/cs.



GREEN



Paper Dinnerware

A. NATURE FRIENDLY®

PLATES & PLATTERS

NATURE FRIENDLY PRODUCTS

Nature Friendly Products' 100% biodegradable and compostable tableware provides consumers with an eco-friendly alternative to traditional disposables. Made from sugar cane bagasse-based renewable resources, they are completely compostable within 50-100 days in home and commercial composting facilities. These products are superior in strength and performance. Non-toxic, hot/cold tolerant, oil and water resistant, microwave and freezer safe.

Classic Round

C6931010	<i>P011</i>	7", Plate	1000/cs.
C6931011	<i>P011R</i>	7", Plate, Retail Pack	1000/cs.
C6931012	<i>P013</i>	9", Plate	500/cs.
C6931013	<i>P013R</i>	9", Plate, Retail Pack	500/cs.
C6931003	<i>P005</i>	10", Plate	500/cs.
C6931004	<i>P005R</i>	10", Plate, Retail Pack	500/cs.
C6931005	<i>P007</i>	10", 3-Compt. Plate	500/cs.
C6931006	<i>P007R</i>	10", 3-Compt. Plate, Retail Pack	500/cs.

Oval Plates

C6931008	<i>P009</i>	9" (7" x 5" Center)	1000/cs.
C6931020	<i>P020</i>	10", Oval Plate	500/cs.
C6931030	<i>P030</i>	12½", Oval Plate	500/cs.

Ridged Edge

C6931000	<i>P001</i>	6", Plate	1000/cs.
C6931001	<i>P002</i>	7", Plate	1000/cs.
C6931002	<i>P003</i>	8", Plate	1000/cs.



B. NATURE FRIENDLY® BOWLS

NATURE FRIENDLY PRODUCTS

Nature Friendly Products' 100% biodegradable and compostable tableware provides consumers with an eco-friendly alternative to traditional disposables. Made from sugar cane bagasse-based renewable resources, they are completely compostable within 50-100 days in home and commercial composting facilities. These products are superior in strength and performance. Non-toxic, hot/cold tolerant, oil and water resistant, microwave and freezer safe.

Classic Bowls

C6932002	<i>L003</i>	12 oz.	500/cs.
C6932003	<i>L003R</i>	12 oz., Retail Pack	500/cs.
C6932038	<i>L044</i>	13½ oz.	1000/cs.
C6932039	<i>L044R</i>	13½ oz., Retail Pack	24/25/cs.

Barreled Soup Bowl & Lids

C6932021	<i>L026B</i>	12 oz., Bowl	500/cs.
C6932022	<i>L027</i>	14 oz., Bowl	600/cs.
C6932001	<i>L001B</i>	16 oz., Bowl	500/cs.
C6932014	<i>L014B</i>	32 oz., Bowl	500/cs.
C6932020	<i>L026A</i>	Fits 12 oz. Bowl	500/cs.
C6933011	<i>L028</i>	Fits 14 oz. Bowl	500/cs.
C6932023	<i>L028</i>	Fits 14 oz. Bowl	600/cs.
C6932000	<i>L001A</i>	Fits 16 oz. Bowl	500/cs.
C6932013	<i>L014A</i>	Fits 32 oz. Bowl	500/cs.

Square Bowl & Lid

C6933006	<i>B021</i>	5½" x 5½", Bowl	450/cs.
C6933005	<i>B020</i>	5½" x 5½", Lid	450/cs.



GREEN

Paper Dinnerware



A. PLACESETTER® PREFERRED™ DINNERWARE PACTIV

Earthchoice® bagasse blend tableware. Made of a blend of bagasse (sugar cane) and bamboo, which are sustainable, annually renewable resources. ASTM D 6868 certified and compostable. Natural white exterior. Resist grease, moisture and help eliminate messy leaks.

16206900	MC50008	8 oz., Bowl	1000/cs.
16206887	MC50012	12 oz., Bowl	1000/cs.
16206884	MC50016	16 oz., Bowl	500/cs.
16206879	MC50006	6", Plate	1000/cs.
16206899	MC500070001	6 ³ / ₄ ", Snack Plate	1000/cs.
16206895	YMC500090001	8 ³ / ₄ ", Plate	500/cs.
16201577	YMC500110001	8 ³ / ₄ ", 3-Compt. Plate	500/cs.
16206881	MC50010	10", Plate	500/cs.
16206896	MC50044001	10", 3-Compt. Plate	500/cs.
16206888	MC50043	7 ¹ / ₂ " x 10" x 1", Oval Platter	500/cs.
16206898	YMC500470001	9 ⁷ / ₈ " x 12 ¹ / ₂ ", Oval Platter	500/cs.



B. PLACESETTER® SELECT HEAVY-DUTY PAPER DINNERWARE PACTIV

Coated for extra strength as well as grease and moisture resistance. This durable, heavy-weight tableware is oil and moisture-resistant. Placesetter® Select plates are also cut-resistant and work well for any occasion. Plates are safe for use in microwave ovens. Bright White plates are suitable for all food service applications.

16202516	PSP0515PUNPC	12 oz., Bowl	1000/cs.
16202515	PSP0605PUNPCF	6", Fluted Plate, White	1000/cs.
16202514	PSP0705PUNPC	7", Plate, White	1000/cs.
16202513	PSP0905PUNPC	8 ³ / ₄ ", Plate, White	500/cs.
16202512	PSP1005PUNPC	10 ¹ / ₄ ", Plate, White	500/cs.



C. SOUP BOWL & LID TRELLIS EARTH®

100% biodegradable. Non-toxic. Microwaveable and steamer-safe.

C4780053	WFW09	20 oz., Bowl	300/cs.
C4780052	WFW10	Lid Fits 20 oz.	300/cs.



D. RECTANGLE BOWL & LID TRELLIS EARTH®

100% biodegradable. Non-toxic. Microwaveable and steamer-safe.

C4780046	WFW07	16 oz., Bowl	300/cs.
C4780051	WFW08	Lid Fits 16 oz.	300/cs.



E. DEEP MEAL PLATE & LID TRELLIS EARTH®

When you're serving a giant veggie burrito, black beans, and rice, or a taco salad, or any other full fledged entree, you need a food service plate that can make your customers proud to be your customer. Trellis Earth® means business with this entree platter. It's deep and it's strong; made to stand up to your restaurant demands yet biodegradable and earth friendly.

C4780048	WFD31	10 ¹ / ₄ "	200/cs.
----------	-------	----------------------------------	---------

Lid

Fits WFD-31 deep meal plate.

C4780047	WFD32	Plate Cover	200/cs.
----------	-------	-------------	---------



GREEN



PLA Dinnerware/Cutlery

PLA DINNERWARE



A. NATURE FRIENDLY® PLA DINNERWARE

NATURE FRIENDLY PRODUCTS

Nature Friendly Products' 100% biodegradable and compostable PLA containers and trays provide consumers with an eco-friendly alternative to traditional disposables. Made from corn-based PLA renewable resources, they are completely compostable within 50-100 days in commercial composting facilities. These products are superior in strength and performance, non-toxic, and clear in color.

C6938050	<i>SB120300</i>	10 oz., Salad Bowl	1000/cs.
C6938051	<i>SB141500</i>	18 oz., Salad Bowl	1000/cs.
C6938052	<i>SB1781000</i>	36 oz., Salad Bowl	500/cs.
C6938056	<i>L12025</i>	Fits 10 oz., Dome Lid	1000/cs.
C6938057	<i>L14128</i>	Fits 18 oz., Dome Lid	1000/cs.
C6938058	<i>L17832</i>	Fits 36 oz., Dome Lid	500/cs.

CUTLERY



B. NATURE FRIENDLY® CUTLERY

NATURE FRIENDLY PRODUCTS

Made from a proprietary biodegradable resin. 100% biodegradable and compostable. Completely compostable within 50-100 days in properly managed composting facilities. Superior strength, quality performance. High temperature resistant up to 190°F. Impermeable and non-toxic.

C6935003	<i>CHW300</i>	Spoon (Bulk/100)	20/100/cs.
C6935009	<i>CHW302</i>	Spoon (Bulk/1000)	1000/cs.
C6935006	<i>CHW301</i>	Spoon (Individually Wrapped)	5/100/cs.
C6935001	<i>CHW100</i>	Fork (Bulk/100)	20/100/cs.
C6935007	<i>CHW102</i>	Fork (Bulk/1000)	1000/cs.
C6935004	<i>CHW101</i>	Fork (Individually Wrapped)	5/100/cs.
C6935002	<i>CHW200</i>	Knife (Bulk/100)	20/100/cs.
C6935008	<i>CHW202</i>	Knife (Bulk/1000)	1000/cs.
C6935005	<i>CHW201</i>	Knife (Individually Wrapped)	5/100/cs.
C6935050	<i>CHW1200</i>	Cutlery Combo Kit (4 Boxes/300 pc.)	1200/cs.



C. BIOPLASTIC CUTLERY

TRELLIS EARTH®

Bagged in a Trellis Earth® biodegradable bioplastic bag for a complete environmentally responsible package. Bioplastic cutlery is made from corn polymers, starches and complementary ingredients to create a blend that is 100% biodegradable and microwave or freezer safe. Just as effective as conventional plastic cutlery.

C4780033	<i>WFS03</i>	Spoon, White	3000/cs.
C4780045	<i>WFS10</i>	Soup Spoon, White	1000/cs.
C4780054	<i>WFS13</i>	Spork, White	1000/cs.
C4780002	<i>WFS02</i>	Fork, White	1000/cs.
C4780004	<i>WFS04</i>	Knife, White	1000/cs.



D. BIOPLASTIC CUTLERY

TRELLIS EARTH®

Retail inner packs include six inner cartons ready for stocking on shelves. Each inner retail pack is bar coded.

C4780092	<i>WFS53</i>	Spoons, 100 ct.	600/cs.
C4780071	<i>WFS66</i>	Spoons, 500 ct.	3000/cs.
C4780094	<i>WFS58</i>	Soup Spoons, 100 ct.	600/cs.
C4780069	<i>WFS68</i>	Soup Spoons, 500 ct.	3000/cs.
C4780076	<i>WFS74</i>	Forks, 60 ct.	1200/cs.
C4780091	<i>WFS52</i>	Forks, 100 ct.	600/cs.
C4780072	<i>WFS65</i>	Forks, 500 ct.	3000/cs.
C4780093	<i>WFS54</i>	Knives, 100 ct.	600/cs.
C4780070	<i>WFS67</i>	Knives, 500 ct.	3000/cs.

Cutlery/Plastic Cups



A. BIOPLASTIC CUTLERY SETS TRELLIS EARTH®

Cover all the bases with these three-piece cutlery sets of bioplastic forks, knives, and spoons. Your customers will be pleasantly surprised when they see their takeout order packed with our eco-friendly cutlery. Bioplastic cutlery is made from corn polymers, starches and complementary ingredients to create a blend that is 100% biodegradable and microwave or freezer safe. Just as effective as conventional plastic cutlery.

C4780074	<i>WFS71</i>	20 Sets	1200/cs.
C4780090	<i>WFS51</i>	50 Sets	900/cs.
C4780075	<i>WFS72</i>	50 Sets	2400/cs.
C4780073	<i>WFS61</i>	200 Forks, 150 Spoons, 100 Knives	2700/cs.
C4780018	<i>WFS01</i>	250 Sets Bagged Basic	1000/cs.
C4780064	<i>WFS31</i>	250 Sets Bagged Premium	1000/cs.



B. BULK BIOPLASTIC CUTLERY TRELLIS EARTH®

Made from corn polymers, starches and complementary ingredients to create a blend that is 100% biodegradable and microwave or freezer safe.

C4780055	<i>WFS11</i>	Tasting Spoon, 1000 ct., White	1000/cs.
C4780063	<i>CTS03</i>	Tasting Spork, 500 ct.	2500/cs.
C4780006	<i>WFS06</i>	Spoon, 100 ct., White	1000/cs.
C4780024	<i>WFS08</i>	Soup Spoon, 100 ct., White	1000/cs.
C4780023	<i>WFS09</i>	Spork, 100 ct., White	1000/cs.
C4780005	<i>WFS05</i>	Fork, 100 ct., White	1000/cs.
C4780007	<i>WFS07</i>	Knife, 100 ct., White	1000/cs.



C. PREMIUM BIOPLASTIC CUTLERY TRELLIS EARTH®

Premium BioPlastic is stronger, heavier and more rigid than basic cutlery. Works beyond boiling, up to 248°F. Textured handles with Trellis trademark. Made from corn polymers, starches and complementary ingredients to create a blend that is 100% biodegradable and microwave or freezer safe.

C4780081	<i>WFS36</i>	Spoon, Beige	1000/cs.
C4780080	<i>WFS35</i>	Fork, Beige	1000/cs.
C4780082	<i>WFS37</i>	Knife, Beige	1000/cs.



D. MALIBU COMPOSTABLE CUTLERY WNA COMET

Mediumweight disposable cutlery. Meets ASTM D6400 for biopolymers. Also compost using Cedar Grove's stringent test methods.

12200195	<i>CGFB120265</i>	Fork, Brown	600/cs.
-----------------	-------------------	-------------	---------

E. STATESMEN COMPOSTABLE CUTLERY WNA COMET

Our compostable line of products is an ecologically sound and practical choice. Earthsense™ offers superior performance and appearance vs. other "green" disposable products. Meets ASTM D6400 for biopolymers. Also compost using Cedar Grove's stringent test methods. Heavyweight.

12200149	<i>CGFB420605</i>	Spoon, Brown	600/cs.
12200150	<i>CGFB410605</i>	Fork, Brown	600/cs.
12200148	<i>CGFB430605</i>	Knife, Brown	600/cs.



PLASTIC CUPS

F. NATURE FRIENDLY® PLA COLD CUPS NATURE FRIENDLY PRODUCTS

Nature Friendly Products' 100% biodegradable and compostable PLA cold cups, lids and straws provide consumers with an eco-friendly alternative to traditional disposables. Made from corn-based PLA renewable resources, these products are completely compostable within 50-100 days in home and commercial composting facilities, and are non-toxic and superior in strength and performance.

C6930003	<i>GC16SR</i>	16/18 oz., Retail Pack	1000/cs.
C6938003	<i>PLA98540</i>	16 oz.	1000/cs.
C6938004	<i>PLA98650</i>	22 oz.	1000/cs.
C6938012	<i>L988K</i>	Flat Lid Fits 16/22 oz. Cups	1000/cs.



GREEN



Plastic Cups/Hot Beverage Cups



A. EARTHCHOICE® PLA CUPS & LIDS PACTIV

Made with Ingeo™ - 100% annually renewable material made from plants. Exceptional clarity - makes drink identification easy and presents contents in an upscale way. Exceptional strength - durable, made tough for everyday demand. Custom printing available - communicates brand image. Optimized cube utilization packs - efficient case packs for shipping. Snap lock lids. ASTM D 6400 certified and compostable.

16202475	<i>YPLA9C</i>	9 oz., Clear	975/cs.
16202474	<i>YPLA1412C</i>	12-14 oz., Clear	680/cs.
16202473	<i>YPLA160C</i>	16 oz., Clear	696/cs.
16202472	<i>YPLA21C</i>	20 oz., Clear	600/cs.
16202469	<i>YPLA24C</i>	24 oz., Clear	580/cs.
16202476	<i>YLPADL24C</i>	Dome Lid Fits 12, 14, 16, 20, 24 oz.	900/cs.
16202042	<i>YLPLA24C</i>	Straw Slot Lid Fits 12, 14, 16, 20, 24 oz.	915/cs.



B. BARE® ECO-FORWARD® RECYCLED CONTENT PLASTIC COLD CUPS SOLO®

Supporting the use of post-consumer recycled content is a key tenet of Solo's Eco-Forward® platform. Requiring post-consumer recycled materials, instead of post industrial sources, encourages consumer recycling and creates market demand for consumer recycled materials. Solo's Eco-Forward® offering includes products made with recycled PET water bottles and containers and paper collected from offices and school recycling programs.

18201013	<i>RTP16J9036</i>	16 oz., RPET, Bloom	1000/cs.
18201001	<i>RTN20J9036</i>	20 oz., RPET, Bloom	1000/cs.
18200998	<i>RTD24J9036</i>	24 oz., RPET, Bloom	600/cs.

HOT BEVERAGE CUPS



C. ECOTAINER® HOT CUPS INTERNATIONAL PAPER

Made with fully renewable resources; fiber from sustainably managed forests and Ingeo™ a plant-based material (PLA). Meets Sustainable Forestry Initiative® (SFI®) Chain-of-Custody certification standards. Meets ASTM Standards for Compostability. Certified by the Biodegradable Products Institute (BPI). Performance is comparable to standard single-use paper disposables. Made in the USA.

14700080	<i>SMRE8</i>	8 oz., ecotainer®	1000/cs.
14703034	<i>SMME10COMPASS</i>	10 oz., Compass	1000/cs.
14700350	<i>SMRE12</i>	12 oz., ecotainer®	1000/cs.
14700351	<i>SMRE16</i>	16 oz., ecotainer®	1000/cs.



D. TRAVELER LIDS INTERNATIONAL PAPER

Domed sipper lid.

14700227	<i>LHRDS8</i>	Fits 8 oz., White	1000/cs.
14700300	<i>LHRDS16</i>	Fits 12, 16, 20, 24 oz., White	1200/cs.



E. CUP BUDDY® INTERNATIONAL PAPER

Fits 10 to 24 oz. cups. Locks in place with heat-activated adhesive. Easy to grip texture.

Compostable and recyclable.

14704002	<i>RCDK20</i>	Cup Buddy®	1200/cs.
-----------------	---------------	------------	----------



F. BARE® ECO-FORWARD® POST CONSUMER FIBER (PCF) PAPER HOT CUPS SOLO®

Supporting the use of post-consumer recycled content is a key tenet of Solo's Eco-Forward® platform. PCF hot cups contain paper which has completed the product life cycle as a consumer item and would otherwise end up in a landfill, such as paper collected from offices and school recycling programs. This post-consumer recycled fiber is incorporated into the cup reducing the use of virgin materials and the impact on valuable natural resources.

18200989	<i>374RCJ8484</i>	4 oz., Bare™	1000/cs.
18200991	<i>378RCJ8484</i>	8 oz., Bare™	1000/cs.
18200993	<i>410RCJ8484</i>	10 oz. Squat, Bare™	1000/cs.
18200992	<i>370RCJ8484</i>	10 oz., Bare™	1000/cs.
18200994	<i>412RCJ8484</i>	12 oz., Bare™	1000/cs.
18200995	<i>316RCJ8484</i>	16 oz., Bare™	1000/cs.
18200997	<i>420RCJ8484</i>	20 oz., Bare™	600/cs.

Straws/Beverage & Dispenser/Luncheon Napkins



STRAWS

A. NATURE FRIENDLY® STRAWS NATURE FRIENDLY PRODUCTS

Nature Friendly Products' 100% biodegradable and compostable tableware provides consumers with an eco-friendly alternative to traditional disposables. Made from sugar cane bagasse-based renewable resources, they are completely compostable within 50-100 days in home and commercial composting facilities. These products are superior in strength and performance. Non-toxic, hot/cold tolerant, oil and water resistant, microwave and freezer safe.

C6935078	ST775N4500W	7 1/4", Giant, Wrapped	2000/cs.
C6935077	ST1025G12300W	10 1/4", Jumbo, Wrapped	1200/cs.



BEVERAGE NAPKINS

B. TORK® ADVANCED BEVERAGE NAPKINS SCA TISSUE

Two-ply and facial grade provides a superior look and feel to other beverage napkins. Box packaging ensures perfect product quality and protection. Napkins are always fresh and sanitary. Made from 100% recycled fiber. EcoLogo® Certified.

14101241	B1241A	9 1/4" x 9 1/4", White, 2-Ply, 1/4 Fold, 300 ct.	3000/cs.
-----------------	--------	--	----------



C. TORK® UNIVERSAL WHITE BEVERAGE NAPKINS SCA TISSUE

Embossed semi-crepe texture gives a higher-quality feel. Inexpensive and perfect for high-volume applications. Special poly-bag packaging ensures perfect product quality and protection for unused napkins. Napkins are always fresh and sanitary, unlike multi-use coasters. Made from 100% recycled and 20% post consumer fibers. EcoLogo® Certified. Compostable Verified by BPI and Independent Verification. Replaces B1141.

14101141	B1141A	9 7/8" x 9 7/8", White, 1-Ply	4000/cs.
-----------------	--------	-------------------------------	----------



DISPENSER/LUNCHEON NAPKINS

D. HI-VALU DISPENSER NAPKINS HI-VALU

High quality napkins are value priced. Ideal for all public environments.

73002654	73002654	11 1/8" x 7", Low Fold, 1-Ply	10000/cs.
-----------------	----------	-------------------------------	-----------



E. TORK® ADVANCED DISPENSER NAPKINS SCA TISSUE

Facial quality enhances feel and absorbency more than usual single-ply service dispenser napkins. An SCA exclusive. Largest open and folded size dispenser napkin making it a good value, fewer napkins needed per serving. Keeps cost down. Bag packaging ensures superior product quality while protecting unused napkins. Always fresh and sanitary. Made from 100% recycled and 20% post consumer fibers offers environmental benefits. A positive image builder. Compostable. EcoLogo® Certified. Compostable Verified by BPI and Independent Verification. 13"W x 12"L open.

14100820	D820	1-Ply, 500 ct., Luxri 13, 6 1/2"W x 3 3/4"L Folded, White	6000/cs.
14101802	D802A	1-Ply, 500 ct., Luxri 17, 5"W x 6 1/2"L Folded, White	6000/cs.

Embossing and semi-crepe texture gives a quality feel. Bag packaging ensures superior product quality while protecting unused napkins. Always fresh and sanitary. Made from 100% recycled fiber and a bleach-free process. EPA Compliant (minimum 90% post consumer content) offers environmental benefits. A positive image builder. Compostable. EcoLogo® and Green Seal™ Certified. Compostable Verified by BPI and Independent Verification.

14100826	D826E	1-Ply, 500 ct., Luxri 13, 6 1/2"W x 3 3/4"L Folded, Natural	6000/cs.
14100806	D806E	1-Ply, 500 ct., Luxri 17, 5"W x 6 1/2"L Folded, Natural	6000/cs.



GREEN



Dispenser/Luncheon Napkins



A. TORK® ADVANCED ROLLNAP DISPENSER NAPKINS SCA TISSUE

By allowing patrons to take only one napkin at a time, the RollNap napkin dispensing system reduces consumption by up to 25%. Ideal for usage at any high-traffic venue. Its unique design reduces the need for frequent dispenser refills because it holds 40% more napkins than traditional dispensers. Hygienic "pull and tear" system allows customers to touch only the napkins they use. Made from 100% recycled and 20% post consumer fibers. Offers environmental benefits. A positive image builder. Compostable. Replaces DR7050.

14107050 DR7050A 1-Ply, 500 ct., 9" x 17", 5³/₅" x 9" Folded, White 6M/cs.



B. TORK® ADVANCED XPRESSNAP® INTERFOLD DISPENSER NAPKINS SCA TISSUE

Xpressnap napkins are larger than major competitor interfolded napkins offering strength, absorbency and quality to users. One napkin-at-a-time dispensing provides up to a 25% reduction in napkin usage. Smaller than standard napkin cases offers storage savings of up to 50%. Inner bag packaging ensures superior product quality while protecting unused napkins. Made from 100% recycled and 20% post consumer fibers. Offers environmental benefits. A positive image builder. Compostable. EcoLogo® Certified.

14102900 DX900 1-Ply, 500 ct., 13" x 8¹/₂" Open, 6¹/₂" x 4¹/₄" Folded, White 6000/cs.

C. TORK® UNIVERSAL DISPENSER NAPKINS SCA TISSUE

Betsy Tallfold

The taller folded size of this Tork® Universal Dispenser Napkin and compact dispenser is perfect for any venue serving snacks or limited menu items. The small open size and single-ply construction is our lowest cost-per-napkin service. The embossing and semi-crepe texture gives a quality feel. Bag packaging ensures superior product quality while protecting unused napkins. Compostable Verified by BPI and Independent Verification.

- Made from 100% recycled and 20% post consumer fibers offer environmental benefits. A positive image builder. Compostable. Environmental Choice EcoLogo® Certified. Replaces D3052, D3052A.

14100191 D3052B 1-Ply, 625 ct., 6" x 13¹/₂", 3¹/₂" x 6³/₄" Folded, White 10000/cs.

- Made from 100% recycled fiber, 90% post consumer graded material, using a 100% bleach-free process that offers environmental benefits and a positive image. EcoLogo® and Green Seal™ Certified. Replaces D3056E, D3056A.

14103058 D3056B 1-Ply, 625 ct., 6" x 13¹/₂", 3¹/₂" x 6³/₄" Folded, Natural 10000/cs.

Daintifold

Small size keeps per-napkin cost down. Dispensing tab made for controlled usage dispensers provides dramatically reduced napkin waste. The embossing and semi-crepe texture gives a quality feel. Made from 100% recycled fiber and 20% post consumer fibers. Provide environmental benefits. A positive image builder. Compostable. EcoLogo® Certified. Compostable Verified by BPI and Independent Verification.

14103060 D3061A 1-Ply, 250 ct., Daintifold Lowfold, 8⁷/₁₆" x 12", 3¹/₂" x 5" Folded, White 8000/cs.

14106313 D6311A 1-Ply, 334 ct., Thrifty Daintifold, 5¹/₂" x 12", 3¹/₂" x 5" Folded, White 8016/cs.

Masterfold

Embossing and semi-crepe texture gives a quality feel. Identical folded size to full size dispenser napkins provides an open size of 5" shorter making it a big cost savings. Bag packaging ensures superior product quality while protecting unused napkins. Always fresh and sanitary. Compostable Verified by BPI and Independent Verification.

- Made from 100% recycled and 20% post consumer fibers offers environmental benefits. EcoLogo® Certified.

14100780 D780 1-Ply, 500 ct., 13" x 12", 5" x 6¹/₂" Folded, White 6000/cs.

- Made from 100% recycled fiber using a bleach-free process. EPA Compliant (minimum 90% post consumer content) offers environmental benefits. EcoLogo® and Green Seal™ Certified.

14100786 D786E 1-Ply, 500 ct., 13" x 12", 5" x 6¹/₂" Folded, Natural 6000/cs.



GREEN

Dispenser/Luncheon & Dinner Napkins



A. TORK® UNIVERSAL WHITE LUNCHEON NAPKINS SCA TISSUE

Single-ply embossed semi-crepe texture that provides a higher-quality feel and better absorbency. This medium sized luncheon napkin is perfect for food service operations serving light meals. Napkins are always fresh and sanitary. Made from 100% recycled and 20% post consumer fibers. EcoLogo® Certified. Compostable Verified by BPI and Independent Verification.

14103141 L3141 1-Ply, 1/4 Fold, 500 ct., 13" x 11½", 6000/cs.
6½" x 5¾" Folded, White



B. TORK® UNIVERSAL XPRESSNAP® INTERFOLD DISPENSER NAPKINS SCA TISSUE

Its one-at-a-time napkin dispensing design ensures that patrons use fewer napkins and touch only the napkin they use, improving personnel hygiene. XpressNap® napkins are larger than major competitor interfolded napkins offering strength, absorbency and quality to users. Made from 100% recycled fiber and a bleach-free process and 90% post-consumer content. Meets EPA guidelines for post-consumer content (minimum 40% post consumer content) offers environmental benefits and a positive image. Compostable. EcoLogo® and Green Seal™ Certified. Compostable Verified by BPI and Independent Verification.

14100901 DX906E 1-Ply, 500 ct., 13" x 8½" Open, 6000/cs.
6½" x 4¼" Folded, Natural



DINNER NAPKINS

C. HI-VALU DINNER NAPKINS HI-VALU

High quality napkins are value priced. Ideal for all public environments.

73004390 73004390 2-Ply, 1/8 Fold, 15" x 17", White 3000/cs.
73004391 73004391 2-Ply, 1/8 Fold, Embossed, 15" x 17", White 3000/cs.
73004393 73004393 2-Ply, 1/8 Fold, Side-by-Side, 15" x 17", White 3000/cs.
73004392 73004392 2-Ply, 1/8 Straight, Embossed, 15" x 17", White 3000/cs.
73004394 73004394 2-Ply, 1/8 Straight, Embossed, 17" x 17", White 3000/cs.



D. TORK® ADVANCED DINNER NAPKINS SCA TISSUE

The embossed facial quality two-ply Tork® Advanced napkin brings class and practicality to casual dining. This economical napkin is ideal for high-volume applications. Exclusive "tallfold" styling allows silverware to rest on it with little or no overhang. Bag packaging ensures superior product quality while protecting unused napkins. Made from 100% recycled fiber, it offers environmental benefits and is a positive image builder. EcoLogo® Certified.

14102000 NP310A 2-Ply, 1/8 Fold, 375 ct., 15"W x 16¼"L Open, 3000/cs.
3¾"W x 8⅞"L Folded, White

The Sea Shell embossing and facial quality two-ply brings class and practicality to casual dining. High brightness provides a quality look. Quarter fold design offers quick and easy wrapping of cutlery. Made from 100% recycled fiber. Replaces NP5240 and NP5240A. Environmental Choice EcoLogo® Certified.

14102004 NP5240C 2-Ply, 1/4 Fold, 375 ct., 15"W x 16¼"L Open, 3000/cs.
7½"W x 8⅞"L Folded, White

Embossed, facial quality, three-ply napkin. The tasteful rose embossing combined with three-ply thickness and high brightness provides for a quality look and hand feel. Made from 100% recycled fiber. EcoLogo® Certified.

14102001 NP7380A 3-Ply, 1/8 Fold, 290 ct., 17"W x 16⅞"L Open, 1740/cs.
4¼"W x 8"L Folded, White

14107340 NP7340A 3-Ply, 1/4 Fold, 250 ct., 17"W x 16⅞"L Open, 2000/cs.
8½"W x 8⅞"L Folded, White



GREEN

Dinner Napkins/Table Cover/Hinged Paper



A. TORK® UNIVERSAL DINNER NAPKINS SCA TISSUE

Single-ply embossed facial quality texture provides a higher-quality feel and better absorbency. Inexpensive alternative to multi-ply facial. Perfect for high-volume applications. Made from 100% recycled fiber. EcoLogo® Certified. Compostable Verified by BPI and Independent Verification.

14102003	N5183A	1-Ply, 1/8 Fold, 500 ct., 15" x 16 1/4", 3 3/4" x 8 1/8" Folded, White	2000/cs.
14102006	N5181A	1-Ply, 1/8 Fold, 250 ct., 15" x 17", 3 3/4" x 8 1/2" Folded, White	3000/cs.
14105140	N5140A	1-Ply, 1/4 Fold, 334 ct., 15" x 17", 7 1/2" x 8 1/2" Folded, White	3000/cs.
14107142	N7141A	1-Ply, 1/4 Fold, 334 ct., 17" x 17", 8 1/2" x 8 1/2" Folded, White	4008/cs.



TABLE COVER

B. TORK® PREMIUM FOLDED TABLE COVER SCA TISSUE

Tork® Premium folded table covers have a sturdy poly backing that protects from spills. Soft two-ply tissue delivers the softness and drape of cloth. Disposable for quick and easy cleanup that helps reduce costs.

14100529	540TW	3-Ply, 54"W x 108"L Open, White	20/cs.
----------	-------	---------------------------------	--------

HINGED PAPER CONTAINERS



C. HINGED CONTAINERS BRIDGE-GATE ALLIANCE GROUP

Premium hingeware made from renewable resources. Biodegradable and compostable. FDA approved for food use. Grease and water resistant. Microwaveable. BPI certified.

B7280100	BG6HW	6"	500/cs.
B7280101	BG8HW	8"	200/cs.
B7280102	BG83HW	8", 3-Compt.	200/cs.
B7280103	BG9HW	9"	200/cs.
B7280104	BG93HW	9", 3-Compt.	200/cs.
B7280107	BGHOAGIE	Hoagie	250/cs.

D. HINGED CONTAINERS BRIDGE-GATE ALLIANCE GROUP

Compostable serving ware. Molded fiber pulp product with environmentally advanced technologies, conserving energy and water. Starting with the purest raw materials, the natural by-products of agricultural waste, Bridge-Gate employs a proprietary, self-contained washing and Biopulping process, minimizing ecological impact from field to factory to foodservice. With Bridge-Gate, you and your customers can be assured of compostable, consistently top-quality products that have been produced with the utmost concern for the environment.

B7280200	ECO6HW	6"	4/100/cs.
B7280201	ECO8HW	8"	2/100/cs.
B7280202	ECO83HW	8", 3-Compt.	2/100/cs.
B7280203	ECO9HW	9"	2/100/cs.
B7280204	ECO93HW	9", 3-Compt.	2/100/cs.
B7280205	ECOHOAGIE	Hoagie	2/125/cs.



E. HARVEST COLLECTION™ FOAM HINGED CONTAINERS GENPAK

Compostable dinnerware for foodservice applications. Produced from environmentally friendly, annually renewable resources.

34789246	HCH80	Medium, 8" x 8" x 2 1/2", Harvest Tan	200/cs.
34789236	HCH83	Medium 3-Compt., 8" x 8" x 2 1/2", Harvest Tan	200/cs.

Hinged & Non-Hinged Containers



A. NATURE FRIENDLY®

CLAMSHELL CONTAINERS

NATURE FRIENDLY PRODUCTS

100% biodegradable and compostable tableware provides consumers with an eco-friendly alternative to traditional disposables. Made from sugar cane bagasse-based renewable resources, they are completely compostable within 50-100 days in home and commercial composting facilities. Superior in strength and performance. Non-toxic, hot/cold tolerant, oil and water resistant, microwave and freezer safe.

C6933003	<i>B003</i>	5" x 5"	250/cs.
C6933004	<i>B024</i>	5" x 5", Hamburger	250/cs.
C6933001	<i>B001</i>	7 1/2" x 5", Lunch Box	250/cs.
C6933009	<i>B110</i>	8" x 8"	250/cs.
C6933012	<i>B118</i>	8" x 8", 3-Compt.	200/cs.
C6933002	<i>B002</i>	9" x 5 1/2", 2-Partition Box	500/cs.
C6933007	<i>B025</i>	9" x 9"	200/cs.
C6933013	<i>B119</i>	10" x 10"	250/cs.
C6933010	<i>B111</i>	10" x 10", 3-Compt.	250/cs.



B. EARTHCHOICE® FIBER BLEND HINGED LID CONTAINERS PACTIV

Social responsibility, respect and care for the environment require action today while keeping an eye to the future. Meet the ASTM D 6868 Standards for Compostability. These products are made from sustainable, renewable materials. Made of a blend of fiber and pulp materials. Double tab lock keeps container securely closed. All natural white provides a brilliant, white exterior. Stackable. Soak through resistant design resists grease, moisture and helps eliminate messy leaks. Made in the USA.

16200422	<i>MCH0080</i>	6" x 6" x 2.3", Sandwich 1-Compt.	500/cs.
16200357	<i>MCH0801</i>	8.1" x 8.1" x 2.1", Medium 1-Compt.	200/cs.
16200355	<i>MCH0803</i>	8.1" x 8.1" x 2.1", Medium 3-Compt.	200/cs.
16200359	<i>MCH0089</i>	9" x 6.2" x 3", Utility 1-Compt.	200/cs.
16200353	<i>MCH0901</i>	9.2" x 8.75" x 2.5", Large 1-Compt.	200/cs.
16200352	<i>MCH0903</i>	9.2" x 8.75" x 2.5", Large 3-Compt.	200/cs.



NON-HINGED PAPER CONTAINERS

C. ECOTAINER® FOOD CONTAINERS

INTERNATIONAL PAPER

Made with fully renewable resources; fiber from sustainably managed forests and Ingeo™ a plant-based material (PLA). Meets Sustainable Forestry Initiative® (SFI®) Chain-of-Custody certification standards. Meets ASTM Standards for Compostability. Certified by the Biodegradable Products Institute (BPI). Performance is comparable to standard single-use paper disposables. Made in the USA.

14700332	<i>DFRE8</i>	8 oz.	1000/cs.
14703031	<i>DFRE12COMPASS</i>	12 oz., Compass	1000/cs.



D. FOOD CONTAINER LID

INTERNATIONAL PAPER

Flat/hot vented lid.

14700124	<i>LFRFH12</i>	Fits 12 oz.	1000/cs.
-----------------	----------------	-------------	----------

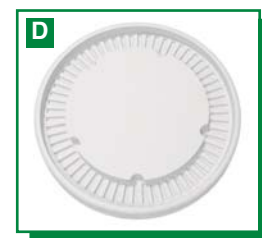

HINGED PLASTIC CONTAINERS

E. EARTHCHOICE® SMARTLOCK® HINGED LID CONTAINERS PACTIV

Social responsibility, respect and care for the environment require action today while keeping an eye on the future. Pactiv has developed a new line of "to-go" hinged lid containers that captures the latest innovations in hybrid materials. EarthChoice® SmartLock® hinged lid containers are made from talc-filled polypropylene which contains on average 40% less plastic polymers than standard polypropylene containers. This hybrid material is microwaveable up to 250°F and is ideal for your hot food take-out menu items. SmartLock® Closure System provides an audible "click" indicating a secure closure. Textured sidewalls provide more secure handling. Stackable.

16201421	<i>CN80600</i>	16 oz., Sandwich 1-Compt.	400/cs.
16201413	<i>CN80801</i>	32 oz., Medium 1-Compt.	200/cs.
16201411	<i>CN80803</i>	4/4/14 oz., Medium 3-Compt.	200/cs.
16201405	<i>CN80901</i>	42 oz., Large 1-Compt.	100/cs.
16201404	<i>CN80903</i>	6/6/18 oz., Large 3-Compt.	100/cs.





Hinged & Non-Hinged Plastic/Portion Cups

A



A. EXPRESSIONS® ECO™ HINGED CONTAINER

SOLO®

Made with environmentally friendly Ingeo™ plastic. Created from plants, not petroleum. ECO™ containers meet the ASTM Standards for Compostability as certified by the Biodegradable Products Institute. They biodegrade in a commercial compost facility within 60-180 days without releasing any toxic residues. Approved by Cedar Grove Composting, Inc., this innovative line of packaging is disposable with food waste –no separation is required!

12604050 0854011 9" x 3", Tan 200/cs.

NON-HINGED PLASTIC CONTAINERS

B. NATURE FRIENDLY®

PLA ROUND CONTAINERS

NATURE FRIENDLY PRODUCTS

Nature Friendly Products' 100% biodegradable and compostable PLA containers and trays provide consumers with an eco-friendly alternative to traditional disposables. Made from corn-based PLA renewable resources, they are completely compostable within 50-100 days in commercial composting facilities. These products are superior in strength and performance, non-toxic, and clear in color.

C6938030	<i>RC95250</i>	8 oz., Container	2000/cs.
C6938031	<i>U120500</i>	16 oz., Container	1000/cs.
C6938032	<i>U1411000</i>	32 oz., Container	600/cs.
C6938035	<i>L959</i>	Fits 8 oz., Lid	2000/cs.
C6938036	<i>L12016</i>	Fits 16 oz., Lid	1000/cs.
C6938037	<i>L14116</i>	Fits 32 oz., Lid	600/cs.

B



C



C. EXPRESSIONS® ECO™ BASES/LIDS

SOLO®

Trendy, two-piece design made with environmentally friendly Ingeo™ plastic. Created from plants, not petroleum. ECO™ containers meet the ASTM Standards for Compostability as certified by the Biodegradable Products Institute. They biodegrade in a commercial compost facility within 60-180 days without releasing any toxic residues. Approved by Cedar Grove Composting, Inc., this innovative line of packaging is disposable with food waste; no separation is required!

Bases

12600021	<i>0972013</i>	7 1/2", Tan	300/cs.
12604015	<i>0974015</i>	9", Tan	150/cs.
12601016	<i>0976016</i>	10 1/4", 3-Compt., Tan	130/cs.

Lids

12603016	<i>0973016</i>	7 1/2", Clear	300/cs.
12603014	<i>0973014</i>	7 1/2", Tan	300/cs.
12605016	<i>0975016</i>	9", Clear	150/cs.
12605014	<i>0975014</i>	9", Tan	150/cs.
12601018	<i>0977018</i>	10 1/4", Clear	130/cs.
12607014	<i>0977016</i>	10 1/4", Tan	130/cs.

PORTION /SOUFFLÉ CUPS

D. NATURE FRIENDLY®

PLA PORTION CUPS

NATURE FRIENDLY PRODUCTS

Nature Friendly Products' 100% biodegradable and compostable PLA cold cups, lids and straws provide consumers with an eco-friendly alternative to traditional disposables. Made from corn-based PLA renewable resources, these products are completely compostable within 50-100 days in home and commercial composting facilities, and are non-toxic and superior in strength and performance.

C6938070	<i>AP6260</i>	2 oz., Portion Cup	2500/cs.
C6938071	<i>AP78105</i>	3 1/2 oz., Portion Cup	2500/cs.
C6938072	<i>AP78130</i>	4 1/2 oz., Portion Cup	2500/cs.
C6938075	<i>L628K</i>	Lid Fits 2 oz.	2500/cs.
C6938076	<i>L789K</i>	Lid Fits 3 1/2, 4 1/2 oz.	2500/cs.

D



Portion/Soufflé Cups/Oyster Pails/Paper Trays



A. EARTHCHOICE® PLA PORTION CUPS PACTIV

Made from a natural plastic material called Ingeo™, an ingenious new material made from plants instead of oil. This means that Ingeo™ is 100% annually renewable, and EarthChoice™ cups and lids are fully compostable in municipal and industrial facilities. Exceptional clarity makes drink identification easy and presents contents in an upscale way. Exceptional strength, durable, made tough for everyday demand. Custom printing available to communicate brand image.

16202561	<i>YSPLA200EC</i>	2 oz.	2400/cs.
16202562	<i>YSPLA300EC</i>	3 1/4 oz.	2400/cs.
16202565	<i>YSPLA400EC</i>	4 oz.	2400/cs.



B. SOUFFLÉ CUPS TRELLIS EARTH®

Perfect for showing you care about saving the environment across your entire food line.

C4780044	<i>WFR05</i>	2 oz.	2500/cs.
C4780041	<i>WFR07</i>	4 oz.	2500/cs.
C4780037	<i>WFR06</i>	Lid Fits 2 oz.	2500/cs.
C4780039	<i>WFR08</i>	Lid Fits 4 oz.	2500/cs.



OYSTER PAILS

C. BIO-PAK® FOOD CONTAINER FOLD-PAK

Microwaveable, stackable, one-piece design requires no assembly. Poly-coated interior with clay-coated exterior. Leak resistant; holds foods, sauces, and gravies. Heat lamp resistant. Retains heat and vents steam effectively.

26080001	<i>01BPWHITEM</i>	#1, 5" x 4 1/2" x 2 1/2", White	450/cs.
-----------------	-------------------	---------------------------------	---------



D. BIO-PLUS® EARTH® FOOD CONTAINERS FOLD-PAK

Microwaveable, stackable, one-piece design requires no assembly. 100% recycled paperboard with a minimum of 35% post-consumer recycled content. Leak resistant; holds foods, sauces, and gravies. Heat lamp resistant. Retains heat and vents steam effectively.

26080043	<i>01BPEARTHM</i>	#1, 5" x 4 1/2" x 2 1/2", Kraft	450/cs.
26080067	<i>02BPEARTHM</i>	#2, 8 1/2" x 6 1/4" x 1 7/8", Kraft	200/cs.
26080042	<i>03BPEARTHM</i>	#3, 8 1/2" x 6 1/4" x 2 1/2", Kraft	200/cs.



PAPER TRAYS

E. NATURAL BROWN TRAY BRIDGE-GATE ALLIANCE GROUP

Compostable serving ware. Molded fiber pulp product with environmentally advanced technologies, conserving energy and water. Starting with the purest raw materials, the natural byproducts of agricultural waste, Bridge-Gate employs a proprietary, self-contained washing and Biopulping process, minimizing ecological impact from field to factory to foodservice. With Bridge-Gate, you and your customers can be assured of compostable, consistently top-quality products that have been produced with the utmost concern for the environment.

B7280014	<i>BGW108T</i>	10 1/2" x 8 1/2" x 1", 5-Compt.	500/cs.
-----------------	----------------	---------------------------------	---------



F. CARRYOUT TRAY GRAPHIC PACKAGING INTL

Natural chipboard. Made from tan bending chip, a type of recycled sheet.

13403825	<i>20013525</i>	10 1/2" x 10 1/2" x 3 3/4"	200/cs.
-----------------	-----------------	----------------------------	---------



G. NATURE FRIENDLY® TRAYS NATURE FRIENDLY PRODUCTS

100% biodegradable and compostable tableware provides consumers with an eco-friendly alternative to traditional disposables. Made from sugar cane bagasse-based renewable resources, they are completely compostable within 50-100 days in home and commercial composting facilities. These products are superior in strength and performance. Non-toxic, hot/cold tolerant, oil and water resistant, microwave and freezer safe.

C6934001	<i>T002</i>	9 1/5" x 6 1/5"	500/cs.
C6934006	<i>T009</i>	8 1/2" x 10 1/2", 5-Compt.	500/cs.





Paper Trays



A. CLASSIC STONEWARE® ROUND PIZZA TRAYS PACTIV

Dual ovenable paperboard can be used in a microwave or conventional oven at temperatures up to 400°F for 60 minutes.

16201056	<i>PCS01305</i>	For 12" Pizza, White	250/cs.
16201055	<i>PCS01505</i>	For 14" Pizza, White	250/cs.

B. PRESSWARE® BAKER'S ASSURANCE® DUAL-OVENABLE TRAY PACTIV

Can be used in microwave or conventional ovens at temperatures up to 400°F for 60 minutes. For hot or cold applications. They can be stored in the freezer or refrigerator without cracking or denting. Made from 90% renewable resources.

16200560	<i>PBA7106</i>	23 oz., 7 ¹ / ₄ " x 11 ⁵ / ₁₆ " x 2 ³ / ₃₂ "	500/cs.
-----------------	----------------	--	---------



C. PRESSWARE® BLUE COUNTRY CLASSIC™ DUAL-OVENABLE TRAYS PACTIV

Blue porcelain-look exterior print provides that home cooked appearance. Can be used in microwave or conventional ovens at temperatures up to 400°F for 60 minutes. Made from 90% renewable resources.

16202614	<i>PBC5613R</i>	14 ¹ / ₂ oz., 4 ²⁷ / ₃₂ " x 6 ¹⁷ / ₃₂ " x 1 ³ / ₈ "	1000/cs.
16202615	<i>PBC5615</i>	16 ³ / ₅ oz., 4 ²⁹ / ₃₂ " x 6 ³ / ₃₂ " x 1 ¹ / ₁₆ "	500/cs.
16200236	<i>PBC6816</i>	32 oz., 6" x 7 ⁷ / ₈ " x 1 ³ / ₄ "	500/cs.
16200625	<i>PBC7014</i>	45 oz., 7 ¹⁵ / ₃₂ " x 9 ³¹ / ₃₂ " x 1 ¹ / ₂ "	250/cs.



D. PRESSWARE® CLASSIC STONEWARE™ DUAL-OVENABLE TRAYS PACTIV

Paperboard trays can be used in microwave or conventional ovens at temperatures up to 400°F for up to 60 minutes. They can be stored in a freezer or refrigerator without cracking or denting, and are ideal for freezer to oven cooking applications. Upscale structural design, along with color and graphics capabilities offer excellent merchandising opportunities for high visual impact. Made from 90% renewable resources. There are two closure options; clear OPS dome lids or peelable film (plastic dome lids are not to be used in microwave or conventional ovens). In the microwave oven, heating is enhanced because Pressware® trays are transparent to microwave energy and cooking hot spot areas are reduced with rounded radius corners and bottoms. White with brown specks.

Round			
16200856	<i>PCS0412</i>	5.7 oz., 4 ³ / ₁₆ " x 1 ¹ / ₄ ", Round	1000/cs.
16202540	<i>PCS0511</i>	7.6 oz., 5 ¹ / ₁₆ " x 1 ¹ / ₈ ", Round	1000/cs.
16200549	<i>C180412</i>	OPS Dome Lid for PCS0412	1000/cs.

Oblong			
16202541	<i>PCS4707</i>	9.7 oz., 4" x 7 ¹ / ₁₆ " x 7 ⁷ / ₈ ", Oblong	1000/cs.
16201054	<i>PCS0713H</i>	12.2 oz., 4 ⁷ / ₈ " x 7 ⁷ / ₃₂ " x 1 ³ / ₈ ", Oblong	1000/cs.
16200865	<i>PCS4512</i>	13 oz., 4 ⁷ / ₈ " x 5 ¹⁵ / ₁₆ " x 1 ¹ / ₄ ", Oblong	1000/cs.
16208501	<i>PCS5611R</i>	13.8 oz., 4 ²⁹ / ₃₂ " x 6 ¹⁷ / ₃₂ " x 1 ³ / ₈ ", Oblong	1000/cs.
16201119	<i>PCS5613</i>	14.5 oz., 4 ³¹ / ₃₂ " x 6 ⁹ / ₁₆ " x 1 ³ / ₈ ", Oblong	1000/cs.
16208503	<i>PCS5613RR1</i>	14.5 oz., 4 ²⁷ / ₃₂ " x 6 ¹⁷ / ₃₂ " x 1 ³ / ₈ ", Oblong	1000/cs.
16201123	<i>PCS5710</i>	15.4 oz., 5 ¹ / ₁₆ " x 7 ¹³ / ₁₆ " x 1", Oblong	500/cs.
16208502	<i>PCS5615</i>	16.8 oz., 4 ²⁹ / ₃₂ " x 6 ³ / ₃₂ " x 1 ¹ / ₁₆ ", Oblong	500/cs.
16207342	<i>PCS5811R</i>	20.5 oz., 5 ²⁹ / ₃₂ " x 8 ⁹ / ₃₂ " x 1 ¹ / ₈ ", Oblong	500/cs.
16205714	<i>PCS5713</i>	20.8 oz., 5 ¹ / ₁₆ " x 7 ²⁵ / ₃₂ " x 1 ³ / ₈ ", Oblong	250/cs.
16202542	<i>PCS5617</i>	21 oz., 5" x 6 ¹ / ₂ " x 1 ⁷ / ₈ ", Oblong	500/cs.
16200203	<i>PCS5713R</i>	21.3 oz., 5 ¹ / ₁₆ " x 7 ¹ / ₁₆ " x 1 ³ / ₈ ", Oblong	500/cs.
16207341	<i>PCS6812R</i>	27.9 oz., 6 ¹ / ₁₆ " x 8 ²⁵ / ₃₂ " x 1 ¹ / ₄ ", Oblong	500/cs.
16201057	<i>PCS6816</i>	32 oz., 6" x 7 ⁷ / ₈ " x 1 ³ / ₄ ", Oblong	500/cs.
16201645	<i>PCS6815</i>	36.7 oz., 6 ⁹ / ₃₂ " x 8 ³ / ₄ " x 1 ⁵ / ₈ ", Oblong	250/cs.
16204646	<i>PCS7014</i>	45 oz., 7 ¹⁵ / ₃₂ " x 9 ³¹ / ₃₂ " x 1 ¹ / ₂ ", Oblong	250/cs.
16200251	<i>PCS81116</i>	64.3 oz., 8 ⁹ / ₁₆ " x 11 ³¹ / ₃₂ " x 1 ³ / ₄ ", Oblong	250/cs.
16200646	<i>C185611R</i>	Clear, OPS Dome Lid for PCS5611R	1000/cs.
16200648	<i>C1881116</i>	Clear, OPS Dome Lid for PCS81116	250/cs.



Square			
16204403	<i>PCS4403</i>	3.5 oz., 4 ⁵ / ₁₆ " x 4 ⁵ / ₁₆ " x 3 ⁸ / ₈ ", Square	3000/cs.
16201106	<i>PCS4412</i>	5.8 oz., 4 ³ / ₁₆ " x 4 ³ / ₁₆ " x 1 ¹ / ₄ ", Square	1500/cs.
16201053	<i>PCS4413</i>	9.5 oz., 4 ⁵ / ₈ " x 4 ⁵ / ₈ " x 1 ³ / ₈ ", Square	1000/cs.

GREEN

Paper Trays/Bakery Boxes/Pan Liners/Bags



A. PRESSWARE® EBONY PREMIER® DUAL-OVENABLE TRAYS PACTIV

Solid black interior and exterior to enhance food product presentation. Can be used in microwave or conventional ovens at temperatures up to 400°F for 60 minutes. Made from 90% renewable resources.

16200852	PEP4512	13 oz., 4 ⁷ / ₈ " x 5 ²⁹ / ₃₂ " x 1 ¹ / ₄ "	1000/cs.
16200600	PEP5613R	14.5 oz., 4 ²⁹ / ₃₂ " x 6 ¹⁷ / ₃₂ " x 1 ³ / ₈ "	500/cs.
16201504	PEP5615	16.8 oz., 4 ¹⁵ / ₁₆ " x 6 ⁵ / ₃₂ " x 1 ¹¹ / ₁₆ "	500/cs.
16200599	PEP5713R	21.3 oz., 5 ¹⁵ / ₃₂ " x 7 ¹⁵ / ₃₂ " x 1 ³ / ₈ "	500/cs.
16201503	PEP6816	32 oz., 6 ¹ / ₃₂ " x 7 ¹⁵ / ₁₆ " x 1 ³ / ₄ "	500/cs.
16209121	PEP7014	45 oz., 7 ¹⁵ / ₃₂ " x 9 ³¹ / ₃₂ " x 1 ¹ / ₂ "	250/cs.



B. PRESSWARE® DOME LIDS PACTIV

Clear OPS dome lids for Pressware trays.

16201118	CI85613	Fits 5613	1000/cs.
16200012	CI85613R	Fits 5613R	1000/cs.
16200606	CI85615	Fits 5615	1000/cs.
16201125	CI85710	Fits 5710	500/cs.
16200848	CI85713	Fits 5713	250/cs.
16205712	CI85713R	Fits 5713R	500/cs.
16208839	CI86816	Fits 6816	500/cs.
16200636	CI8D714	Fits 7014	250/cs.

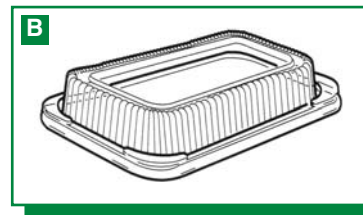

BAKERY BOXES

C. BAKERS' CRAFT™ BAKERY BOXES CLIMAX MFG

Manufactured from 100% recycled fiber, 30% post-consumer waste.

Cake Boxes

25234116	BX411615	10" x 10" x 5"	100/cs.
25234117	BX411616	1/4 Sheet, 14" x 10" x 4"	100/cs.
25234118	BX441622	1/2 Sheet, 19" x 14" x 4"	50/cs.
25234115	BX451623	Full Sheet, 26" x 18" x 3"	25/cs.

Pie Boxes

25234111	BX411611	8" x 8" x 2 ¹ / ₂ "	100/cs.
25234112	BX493370	10" x 10" x 2 ¹ / ₂ "	100/cs.

Donut Cartons

25234114	BX411634	1/2 Dozen, 9" x 4 ¹ / ₂ " x 4"	100/cs.
25234113	BX411636	1 Dozen, 10 ¹ / ₄ " x 8" x 4"	100/cs.



PAN LINERS

D. ECOCRAFT® BAKE 'N' REUSE™ PAN LINERS BAGCRAFT/PAPERCON

Comparable to a silicone greaseproof baking sheet but without the chromium. It is manufactured from chlorine-free pulp and approved for standard waste disposal. The liners have excellent heat retention for baking of high-moisture items and can be used at temperatures up to 425°F. 100% recycled.

16400180	030010	16 ³ / ₈ " x 24 ³ / ₈ ", Medium Temperature	1000/cs.
----------	--------	---	----------



HANDLE / MERCHANDISE BAGS

E. PRIME SOURCE® SHOPPING BAGS PRIME SOURCE®

Eco-friendly reusable fabric shopping bag. This attractive, long-lasting, non-woven shopping bag folds into a compact 7" x 6¹/₂" pack, making it easy to carry when you shop. Perfect for customer shopping needs.

76008624	76008624	13 ¹ / ₂ " x 16 ¹ / ₂ " x 15", Black	100/bdl.
76008620	76008620	13 ¹ / ₂ " x 16 ¹ / ₂ " x 15", Green	100/bdl.
76008622	76008622	13 ¹ / ₂ " x 16 ¹ / ₂ " x 15", Navy	100/bdl.
76008621	76008621	13 ¹ / ₂ " x 16 ¹ / ₂ " x 15", Red	100/bdl.
76008623	76008623	13 ¹ / ₂ " x 16 ¹ / ₂ " x 15", Yellow	100/bdl.



GREEN

Bags/Sandwich Bags/Deli Wrap/Hand Soaps



A. QUIKMATE EZ® T-SHIRT BAGS ASSOCIATED PACKAGING TECH

Engineered convenient T-shirt bag style with integrated tabs. Sizes to fit any purchase requirements. Patented easy-open design. Hardware to fit almost any check stand configuration. Dispensing systems, including racks, trays and rolls designed for maximum checkout productivity.

18302101 4000001 1/6, 12" x 7" x 22", 13 MIC, Gray is the New Green 1000/cs.

B. HIPPO SAK® CROWN POLY

The invincible grocery bag with the strength of paper and the ease of plastic. Hippo Ties™ prevent bag contents from spilling over in the car. Wider and thicker Hippo Handles are more comfortable to carry. Reinforced bottom seal - Hippo Strip™ eliminates weak stress points. Efficient self-opening feature. Reduces plastic bag usage by 35% or more.

28168113 T80013 Hippo 8, 12 1/2" x 7 1/2" x 20 3/5", 13.5 MIC, Natural 1400/cs.

28160051 T89999 Hippo 8, 12 1/2" x 7 1/2" x 20 3/5", 15.5 MIC, Eco, Green 1300/cs.

28160373 T30373 Hippo 12, 12 1/2" x 7 1/2" x 24", 13.5 MIC, Thank You, White 1300/cs.

28168013 T38013 Hippo 12, 12 1/2" x 7 1/2" x 24", 13.5 MIC, Enviro, Natural 1300/cs.

28168015 T38015 Hippo 12, 12 1/2" x 7 1/2" x 24", 15.5 MIC, Enviro, Natural 1100/cs.

28168017 T38017 Hippo 12, 12 1/2" x 7 1/2" x 24", 17.5 MIC, Enviro, Natural 1000/cs.

28169999 T39999 Hippo 12, 12 1/2" x 7 1/2" x 24", 16.5 MIC, Eco, Green 1050/cs.



SANDWICH BAGS

C. ECOCRAFT® SANDWICH BAGS BAGCRAFT/PAPERCON

Less mess with grease resistant paper. Hot or cold applications and microwaveable. Easy-to-eat convenience for single portions.

16400100 300100 Sandwich-Pastry-Cookie Bag, 6 1/2" x 1" x 8", 25#, Natural Kraft 4000/cs.

DELI WRAP

D. ECOCRAFT® INTERFOLDED SHEETS BAGCRAFT/PAPERCON

Excellent moisture barrier with soy wax blend. Quick sanitary pick-up and handling. Separates assorted baked and deli goods. Easy release fresh or frozen.

16401001 010001 6" x 10 3/4", Natural Kraft 10000/cs.

16401608 016008 8" x 10 3/4", Natural Kraft 6000/cs.

16401601 016010 10" x 10 3/4", Natural Kraft 6000/cs.

16406012 016012 12" x 10 3/4", Natural Kraft 6000/cs.

E. ECOCRAFT® DELI WRAP BAGCRAFT/PAPERCON

Grease-resistant multi-purpose sandwich wrap/basket liner. Hot or cold applications and microwaveable. Easy-to-eat convenience for single portions.

16400897 300897 12" x 12", Natural Kraft 5000/cs.

16400898 300898 15" x 16", Natural Kraft 3000/cs.

HAND SOAPS

F. PRIME SOURCE® G2 FOAM SOAP PRIME SOURCE®

A mild, biodegradable foam soap formula. Green Seal™ and EcoLogo® approved.

75004261 75004261 1200 mL 2/cs.

75004260 75004260 1250 mL 3/cs.

75004262 75004262 1500 mL 2/cs.

G. GOJO® GREEN CERTIFIED LOTION HAND CLEANER GOJO

A mild, biodegradable lotion soap formula certified by Green Seal™ and EcoLogo® to meet their joint standard (GS41/CCD-104) for hand cleaners and hand soaps.

35406512 916512 800 mL 12/cs.

35402165 216508 1000 mL, Fits NXT® 8/cs.



GREEN

Hand Soaps & Sanitizers/All Purpose Cleaners



A. GOJO® GREEN CERTIFIED FOAM HAND CLEANER GOJO

A mild, biodegradable foam soap formula certified by Green Seal™ and EcoLogo® to meet their joint standard (GS41/CCD-104) for hand cleaners and hand soaps.

35405715	571506	7½ oz., Tabletop Bottle	6/cs.
35405725	572502	46 oz., Refill Bottle	2/cs.
35405665	566502	1200 mL, TFX Refill	2/cs.
35405166	516503	1250 mL, Fits FMX-12™	3/cs.
35408560	856502	1500 mL, Fits CX™/CXi™	2/cs.
35405266	526502	2000 mL, Fits FMX-20™	2/cs.



B. SOY INDUSTRIAL HAND CLEANER ZEP

Environmentally preferred hand cleaner. Uses a powerful yet mild combination of soy solvents and walnut shell abrasive to loosen tough grime. Apple cinnamon fragrance.

75070080	R05324	1 gal.	4/cs.
-----------------	--------	--------	-------



HAND SANITIZERS

C. PURELL® GREEN CERTIFIED INSTANT HAND SANITIZER FOAM GOJO

Made from 100% naturally renewable ethanol. Meets the USDA BioPreferred program for biobased content. Readily biodegradable non-aerosol foam formula. Meets the EcoLogo® hand sanitizer standard CCD-170 for environmental leadership and proven performance. Helps condition skin with a natural moisturizer.

35400224	519103	1200 mL, FMX Refill	3/cs.
35400217	539102	1200 mL, TFX Refill	2/cs.



D. PURELL® INSTANT HAND SANITIZER FOAM GOJO

Non-aerosol, alcohol-based foam sanitizer with the exclusive Dermaglycerin System™. Clinically proven to improve healthcare worker skin hydration in 14 days. A synergistic moisturizing blend with broad-spectrum antimicrobial efficacy. Contains seven moisturizers for optimal skin conditioning. Fragrance-free, dye-free. Compatible with latex, nitrile and vinyl gloves and CHG. Meets CDC and APIC recommendations.

35409804	579804	535 mL, Pump Bottle	4/cs.
35400183	519803	1200 mL, FMX Refill	3/cs.
35405398	539802	1200 mL, TFX Refill	2/cs.



E. PURELL® GREEN CERTIFIED INSTANT HAND SANITIZER GOJO

Made from 100% naturally renewable ethanol. Meets the USDA BioPreferred program for biobased content. Readily compostable gel formula. Meets the EcoLogo® hand sanitizer standard CCD-170 for environmental leadership and proven performance.

35400219	969112	8 oz. Bottle	12/cs.
35400221	369112	12 oz. Bottle	12/cs.
35400223	579104	535 mL Bottle	4/cs.
35400222	509103	1200 mL, FMX Refill	3/cs.
35400218	549104	1200 mL, TFX Refill	4/cs.



ALL PURPOSE CLEANERS

F. ENVIROPATROL® HEAVY-DUTY CLEANER CARROLL

High performance, extra strength heavy-duty cleaner and degreaser for the toughest of cleaning jobs, from the kitchen to the industrial plant. Replaces conventional kitchen and industrial cleaner/degreasers with an effective environmentally preferable alternative. Quickly removes petroleum-based soils. Use for spray-on and wipe-off cleaning, mop and bucket, automatic scrubbing, pressure washer or manual cleaning procedures. Dilutes at 1 oz./gal. (1:128) for most applications. This product is recognized by the U.S. Environmental Protection Agency Design for the Environment (DfE) Formulator Initiative for its improved environmental and human health characteristics. Cold water effective.

30011982	19828	1 gal.	4/cs.
-----------------	-------	--------	-------



GREEN

All Purpose Cleaners



A. ENVIROPATROL® MULTI-PURPOSE CLEANER CARROLL

Use as a high performance multi-surface cleaner, daily non-alkaline floor cleaner, scrub/recoat detergent, window cleaner, washroom cleaner, odor neutralizer, tile/grout cleaner and brightener and carpet care product. Dilutes at 1 oz./gal. (1:128) for most applications. This product is recognized by the U.S. Environmental Protection Agency Design for the Environment (DfE) Formulator Initiative for its improved environmental and human health characteristics. Cold water effective.

30018528 18528 1 gal. 4/cs.



B. ENVIROPATROL® OXIDE2 CARROLL

Multi-surface cleaner, deodorizer and stain remover. Organic solvent derived from orange and citrus peels fortified with hydrogen peroxide creating a cleaning solution with unequaled ability to dissolve and emulsify soils of all types. Absolutely superior cleaning ability without the use of a petroleum solvent or glycol ethers (butyl cellosolve). It penetrates and emulsifies for easy removal of oils and soils from any washable surface. The hydrogen peroxide cleans stains and takes odor away - safely and instantly. Dilutes at 2 oz./gal. (1:64) for most applications. Cold water effective.

30010196 19623 1 qt. RTU 12/cs.
30010197 19628 1 gal. 4/cs.



C. GREEN WORKS® NATURALLY DERIVED ALL PURPOSE CLEANER CLOROX

A Cleaner That Does It All - Naturally. Powers through grease, grime, dirt and soils with 97% naturally derived ingredients. Safe to use on a wide variety of surfaces throughout kitchens and bathrooms, including stainless steel, sealed granite, chrome. Acknowledged by the U.S. EPA's Design for Environment Program.

38380456 00456 32 oz. 12/cs.
38380457 00457 64 oz., Refill 6/cs.



D. GREEN WORKS® NATURALLY DERIVED DILUTABLE CLEANER CLOROX

Works on grease, grime and dirt. Is safe on multiple surfaces throughout the kitchen and bathroom, including non-wood floors, counters, sinks, stoves, garbage cans and toilets. Performs as well or better than the leading conventional cleaners. Dilutable formula (concentrate). Recognized by the U.S. Environmental Protection Agency Design for the Environment (DfE) Formulator Initiative for its improved environmental and human health characteristics.

38380458 00458 64 oz. 6/cs.



E. AJAX® SCOURING CRÈME COLGATE-PALMOLIVE

No harsh abrasives. Fresh lemon scent. Perfect for modern surfaces; polishes and destains to keep surfaces looking new. Especially effective on vertical surfaces. DfE approved formula.

11901170 04941 24 1/2 oz. 9/cs.

F. FABULOSO® ALL PURPOSE CLEANER COLGATE-PALMOLIVE

Cleans and leaves a long-lasting fresh scent. Effective for a wide variety of cleaning applications. Advanced technology formula penetrates deep into surface to capture grease and soils. Neutral pH makes product safe for people and surfaces. No alkaline builder to leave a residue. No-rinsing step needed in floor cleaning applications. All cleaning agents are biodegradable. Bilingual labeling. DfE approved formula.

11904307 04307 1 gal., Lavender 4/cs.
11904373 04373 1 gal., Ocean Cool 4/cs.



G. SIMPLE GREEN® ALL PURPOSE CLEANER/DEGREASER SIMPLE GREEN

Versatile all purpose cleaner is non-toxic and biodegradable, without harmful bleach or ammonia. Because it is a concentrate, you can use Simple Green full strength or add water to clean just about anything.

73433016 13006 5 gal. 1/ea.

GREEN

All Purpose Cleaners/Degreasers/Glass Cleaners



A. SIMPLE GREEN® CLEAN BUILDING™ ALL PURPOSE CLEANER CONCENTRATE SIMPLE GREEN

Formulated for cleaning all water-safe hard surfaces. Concentrate offers economical dilution, and with no fragrance or volatile organic ingredients, it doesn't adversely impact indoor air quality. Green color makes it easily identified when diluted into secondary containers. Non-toxic, biodegradable, non-caustic, and non-flammable. Makes 65 gallons of ready-to-use cleaner.

73431001 11001 1 gal. 2/cs.



B. Z-VERDANT RTU CLEANER ZEP

Environmentally preferred, easy-to-use cleaner for use on multiple surfaces and tough soils. May be used on any surface not harmed by water. Easily breaks down common soils making it an excellent everyday cleaner. Contains no harmful solvents or harsh chemicals.

75070100 R06901 1 qt. 12/cs.
75070101 R06935 5 gal. 1/ea.



DEGREASERS

C. CRYSTAL SIMPLE GREEN® INDUSTRIAL STRENGTH CLEANER/DEGREASER SIMPLE GREEN

Safe, effective and powerful all purpose cleaner/degreaser for critical cleaning applications that demand a fragrance-free solution. Non-toxic, non-abrasive and no caustic fumes. Exempt from OSHA and EPA special handling and personal protection requirements. Approved for use in federally inspected meat and poultry plants, and meets Montreal Protocol Guidelines and FDA requirements for cleaning cosmetics, medical and pharmaceutical environments. Excellent for use in parts washers, pressure washers, floor scrubbers and other mechanized applicators.

73439128 19128 1 gal. 6/cs.



D. VOC COMPLIANT SOLVENT DEGREASER ZEP

Environmentally preferred, solvent-based degreaser with d-limonene for use where a water-free formula is preferred. Meets all CA-CARB and OTC requirements.

75070113 R07824 1 gal. 4/cs.
75070114 R07835 5 gal. 1/ea.

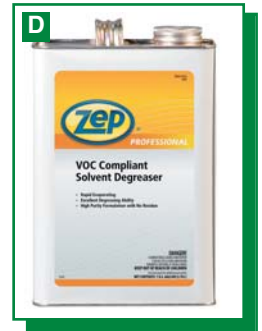

AMMONIATED GLASS CLEANER

E. AJAX EXPERT® GLASS AND MULTI-SURFACE CLEANER COLGATE-PALMOLIVE

Powerful ready-to-use formula requires no mixing and is convenient to use. Dual solvent system cuts through film and grease fast. Contains ammonia for extra cleaning power. Flash dries quickly without streaking or filming. Use on glass, countertops, mirrors and other hard washable surfaces. Contains biodegradable surfactants. Bilingual labeling. DFE approved formula.

11901320 04195 1 gal., Concentrate 4/cs.



NON AMMONIATED GLASS CLEANERS

F. ENVIROPATROL® GLASS & SURFACE CLEANER CARROLL

Use as a high performance glass and utility cleaner. Can be used as a spray and wipe glass cleaner or with a sponge and squeegee. Leaves no residues. Helps prevent resoiling. Use on Plexiglas®, windows, windshields, walls, countertops, cabinets, partitions, light fixtures, stainless steel, chrome, plastic, vinyl and other hard surfaces not harmed by water. Dilutes at 1 oz./gal. (1:128) for most applications. Cold water effective.

30018228 18228 1 gal. 4/cs.



GREEN

Glass Cleaners/Dishwash/Disinfectant/Restroom



A. GREEN WORKS® NATURALLY DERIVED GLASS & SURFACE CLEANER CLOROX

Our product is made using fine natural ingredients such as essential oils and coconut-based cleaners. Cuts through filmy residue and is safe on multiple surfaces throughout the kitchen and bathroom, including glass, mirrors, appliances, stainless steel and sealed granite. Removes tough dirt and residue for a streak-free shine. 95% naturally derived and contains no ammonia. Safe to use on a wide variety of surfaces.

38380459 00459 32 oz., Trigger Sprayer 12/cs.
38380460 00460 64 oz., Refill 6/cs.



B. SIMPLE GREEN® CLEAN BUILDING™ GLASS CLEANER CONCENTRATE SIMPLE GREEN

Specifically for streak and smear-free cleaning of glass and other reflective surfaces. Concentrate offers economical use dilution with no added fragrance or volatile organic ingredients that can adversely impact indoor air quality. Also safe to use on plastics. Non-toxic, biodegradable, non-caustic, and non-flammable formulation. Makes 31 gallons of ready-to-use cleaner.

73431201 11201 1 gal. 2/cs.



HAND DISHWASH - LIQUID

C. PALMOLIVE® ORIGINAL DISHWASHING LIQUID COLGATE-PALMOLIVE

Cuts through stubborn grease. Rich, thick formula removes dried-on, cooked-on food. pH balanced. Long-lasting performance makes it an economical choice. DfE approved formula. Ready-to-use.

11901702 01410 3.75 oz., Green 72/cs.
11901640 04910 1 gal., Green 4/cs.
11901660 04911 5 gal., Green 1/ea.



D. ULTRA PALMOLIVE® DISHWASHING LIQUID FOR POTS & PANS COLGATE-PALMOLIVE

Highly concentrated formula tackles the toughest foodservice dishwashing tasks. Ideal for use as a presoak. Great as a general all-purpose cleaner, its grease-cutting ability makes it perfect for cleaning tables, countertops, windows, mirrors and more. Ocean Breeze scent. DfE approved formula.

11900056 40043 1 gal. 4/cs.



LIQUID DISINFECTANT

E. BROAD SPECTRUM DISINFECTANT CLEANER ZEP

Environmentally preferred, ready-to-use germicidal cleaner and deodorant. Effective on mold and mildew. Conforms to CDC blood borne pathogen procedures for environmental services. Kills Parvo, Tuberculosis, HIV-1, MRSA, and Staph.

75070031 R02301 1 qt. 12/cs.
75070032 R02324 1 gal. 4/cs.



RESTROOM CLEANERS

F. ENVIROPATROL® RESTROOM CLEANER CARROLL

Use as a high performance washroom general purpose cleaner. Concentrated cleaner for removal of soap scum, mildew, lime, water scale and rust deposits on porcelain, tile, ceramic tile and fiberglass surfaces. Safe for daily use on painted surfaces, porcelain, porcelain enamel, aluminum or stainless steel without etching or damaging them. Dilutes at 1 oz./gal. (1:128) for most applications. Cold water effective.

30014402 44028 1 gal. 4/cs.

GREEN

Restroom/Bowl Cleaners/Drain/Deodorant/Floor



A. GREEN WORKS® NATURALLY DERIVED BATHROOM CLEANER CLOROX

Contains powerful cleaning agents that quickly clean tough stains such as soap scum, hard water and rust. Made with plant-based, biodegradable cleaning ingredients. Cleans with no harsh chemical fumes or residue and is never tested on animals. Works on multiple surfaces throughout bathrooms, including counters, chrome, sinks and toilets.

38380452 00452 24 oz. 12/cs.



B. SIMPLE GREEN® CLEAN BUILDING™ BATHROOM CLEANER CONCENTRATE SIMPLE GREEN

Specifically formulated for cleaning scale and scum types of soils typically found on hard bathroom surfaces. Pink color makes it easily identified when diluted into secondary containers. Safe to use on washable hard surfaces such as ceramic, glazed tile, Corian®, Formica, grout, faucets and fixtures, porcelain, and cured fiberglass. Non-toxic, biodegradable, non-caustic, and non-flammable. Makes 21 gallons of ready-to-use cleaner.

73431101 11101 1 gal. 2/cs.



BOWL CLEANERS

C. GREEN WORKS® NATURALLY DERIVED TOILET BOWL CLEANER CLOROX

Powerful gel formula cuts through rust, hard water and even stubborn mineral deposits. 99% naturally derived and safe for septic systems. Contains no bleach or phosphorus and is made with plant and mineral-based ingredients. Angled spout makes cleaning under the rim easy.

38380451 00451 24 oz. 12/cs.



D. NON-ACID DEODORIZER & TOILET BOWL CLEANER ZEP

Environmentally preferred, non-acidic cleaner and deodorizer, removes scale, stains, and scum. Use on toilet bowls, tiles, sinks, showers, and bathroom fixtures.

75070006 R00301 1 qt. 12/cs.



DRAIN MAINTAINER

E. BIOLOGICAL DRAIN MAINTAINER ZEP

Environmentally preferred drain maintenance product powered by enzymatic activity. Safe for use in septic systems to keep drains free flowing. A biological solution for safe, routine maintenance.

75070036 R02635 5 gal. 1/ea.



LIQUID DEODORANT

F. Z-FRESH ODOR NEUTRALIZERS ZEP

Environmentally preferred, highly effective odor neutralizer. Chemically eliminates the source of odors and replaces them with a pleasant clean fragrance.

75070022 R01601 1 qt., Breeze 12/cs.

75070025 R01901 1 qt., Potpourri 12/cs.

75070026 R02001 1 qt., Subdue 12/cs.



ALL PURPOSE FLOOR CLEANERS

G. BROAD SPECTRUM DISINFECTANT FLOOR CLEANER ZEP

Environmentally preferred neutral floor and hard surface cleaner disinfects floors and hard surfaces. Hospital grade disinfectant eliminates bacteria, fungi and viruses including HIV, MRSA, and Staph.

75070027 R02124 1 gal. 4/cs.

75070028 R02135 5 gal. 1/ea.



GREEN

Floor Cleaners/Wood Floor Care/Strippers/Neutral



A. Z-VERDANT ALL PURPOSE CLEANER ZEP

Environmentally preferred, concentrated all purpose cleaner. May be used on any surface not harmed by water. Effective on a variety of soils such as wax buildup, fingerprints, and black marks on floors. May be used for most daily cleaning and maintenance operations. Contains no harmful solvents or harsh chemicals.

75070133	<i>R08924</i>	1 gal., Concentrate	4/cs.
75070134	<i>R08935</i>	5 gal., Concentrate	1/ea.



B. Z-VERDANT AUTO SCRUBBER SOLUTION ZEP

Environmentally preferred auto scrubber concentrate. Removes oil, grease, and dirt from floors and most other washable surfaces. Biodegradable, no petroleum, solvents or caustics.

75070129	<i>R08724</i>	1 gal.	4/cs.
75070130	<i>R08735</i>	5 gal.	1/ea.

WOOD FLOOR CARE

C. MURPHY® OIL SOAP COLGATE-PALMOLIVE

Economical, natural cleaner is ideal for mopping wood floors, paneling and other large wood surfaces. Naturally cleans finished and hard surfaces. EPA DfE approved formula.

11901101	<i>01101</i>	16 oz.	12/cs.
11902106	<i>01106</i>	32 oz., Concentrate	12/cs.
11900103	<i>01103</i>	1 gal., Concentrate	4/cs.



FLOOR STRIPPER

D. ENVIROPATROL® WAX & FINISH REMOVER CARROLL

When used as directed, this product is a high performance, ultra low odor, non-toxic, non-corrosive, butyl-free, ammonia-free wax and finish remover. Specially designed to remove conventional zinc crosslinked finishes as well as environmentally preferable zinc-free floor finishes like EnviroPatrol® Metal Free Floor Finish. A highly concentrated rapid response stripper that dissolves multiple coats of finish without the strong and unpleasant odor associated with conventional strippers. Rinses quickly without leaving residual alkali to interfere with finish application. Dilute 1 part to 6 parts of cold water for most applications. This product has been 3rd party certified by Green Seal™ according to GS-40 Environmental Standard and is recognized by the U.S. Environmental Protection Agency Design for the Environment (DfE) Formulator Initiative. Cold water effective.

30011276	<i>35028</i>	1 gal.	4/cs.
30011274	<i>35019</i>	5 gal.	1/ea.



FLOOR NEUTRAL CLEANER

E. ENVIROPATROL® NEUTRAL CLEANER CARROLL

Use as a highly efficient multi-use cleaner for floors, walls, woodwork and other washable surfaces where a neutral pH range is desirable. Quickly removes soil without dulling, damaging, etching, or harming floor finishes even when used for daily applications. Dilutes at 1 oz./gal. (1:128) for most applications. This product is recognized by the U.S. Environmental Protection Agency Design for the Environment (DfE) Formulator Initiative for its improved environmental and human health characteristics. Cold water effective.

30011272	<i>12728</i>	1 gal.	4/cs.
-----------------	--------------	--------	-------



GREEN

Floor Finish/Carpet Cleaners/Stain Remover



FLOOR FINISH

A. ENVIROPATROL® METAL FREE FLOOR FINISH CARROLL

Designed with the newest in environmentally preferable metal-free polymer technology for sealing and finishing all types of resilient flooring. Does not contain zinc, phthalates or alkyl phenol ethoxylates to harm the environment or interfere with industrial wastewater treatment processes. This state-of-the-art finish has exceptional gloss, durability, soil resistance, detergent resistance, recoatability, removability, and slip resistance. A combination sealer and finish that dries to a smooth, hard, clear and colorless coating in about 30 minutes under normal conditions. Versatile and can be maintained using traditional maintenance procedures including scrub/recoat or high speed burnishing. Third party certified by Green Seal™ according to GS-40 Environmental Standard and is recognized by the U.S. Environmental Protection Agency Design for the Environment (DfE) Formulator Initiative. Cold water effective.

30016728	66728	1 gal.	4/cs.
30011275	ENVIROFIN5G	5 gal.	1/ea.
30010667	66719	5 gal.	1/ea.



B. Z-TREAD BURNISH RESTORER ZEP

Environmentally preferred, concentrated floor gloss restorer cleans and prepares floor for burnishing in one easy step. Eliminates need for frequent stripping and refinishing.

75070058	R03835	5 gal.	1/ea.
-----------------	--------	--------	-------



CARPET CLEANERS

C. SIMPLE GREEN® CLEAN BUILDING™ CARPET CLEANER CONCENTRATE SIMPLE GREEN

Formulated especially for cleaning carpets and rugs. Green Seal™ certified and also certified by the Carpet and Rug Institute. Carpet warranties that call for the use of only CRI-approved products will not be jeopardized. No added fragrance or volatile organic ingredients. Non-toxic, biodegradable, non-caustic, and non-flammable. Makes 22 gallons of ready-to-use cleaner.

73431301	11301	1 gal.	2/cs.
-----------------	-------	--------	-------



D. HIGH FOAM CARPET SHAMPOO ZEP

Environmentally preferred carpet shampoo designed for deep cleaning. "Dry" foam allows for rapid drying and a quicker return to use. Inhibits surface resoiling and leaves behind a fresh fragrance. Safe on stain-resistant treated carpets.

75070015	R01124	1 gal.	4/cs.
75070016	R01135	5 gal.	1/ea.



E. LEMONGRASS CARPET EXTRACTION SOLUTION ZEP

Environmentally preferred carpet cleaner with light lemongrass fragrance. Designed for hot water extraction or bonnet method carpet cleaning. Safe on stain-resistant treated carpets. Friable surfactants dry to a powder which are easily vacuumed up, leaving no residue behind.

75070009	R00624	1 gal., Concentrate	4/cs.
75070010	R00635	5 gal., Concentrate	1/ea.



CARPET STAIN REMOVER

F. BIOENZYMATIC CARPET SPOTTER ZEP

Environmentally preferred, biologically-based carpet spotter removes tough stains from carpets through combined detergent and enzymatic action.

75070014	R01001	1 qt.	12/cs.
-----------------	--------	-------	--------



GREEN



Automotive/Roll Tissue/Jumbo Tissue

GREEN



AUTOMOTIVE

A. FOAMING VEHICLE SHAMPOO

ZEP

Environmentally preferred, ultra-concentrated liquid detergent formulated for friction car and truck washing facilities. Excellent for removing road film, dirt and salt deposits. Won't harm wax finishes.

75070118	R08124	1 gal.	4/cs.
75070119	R08135	5 gal.	1/ea.

ROLL TISSUE



B. GREEN SOURCE™ TOILET TISSUE

PRIME SOURCE®

100% recycled. Chlorine-free. EcoLogo® Certified. Trilingual packaging (English, Spanish, French).

75009500	75009500	400 ct., 4" x 3 ³ / ₄ ", White, 2-Ply	96/cs.
----------	----------	---	--------

C. SCOTT® 100% RF STANDARD TOILET TISSUE

KIMBERLY-CLARK

Made with 100% recycled fiber. Meets EPA standards for 40% minimum post-consumer waste content. Green Seal™ Certified.

15406446	64460	2-Ply, 605 ct., White, 4 ¹ / ₂ " x 4"	80/cs.
----------	-------	---	--------



D. TORK® ADVANCED HIGH-CAPACITY BATH TISSUE

SCA TISSUE

Provides hygienic dispensing while reducing waste and maintenance expense. Enhances the image of everyday washrooms. High capacity rolls eliminate service outages. Embossed rolls enhance bulk and softness. The banded rolls create less waste and source reduction. The easy start tail seal prevents waste. Rapid breakup; ideal for all plumbing systems. Made from 100% recycled fibers. Provides environmental benefits. A positive image builder. Replaces 120298, 110291.

14100086	110291A	1-Ply, 2000 ct., T26 System, 3.9" x 625', White	36/cs.
----------	---------	---	--------



E. TORK® UNIVERSAL BATH TISSUE ROLL

SCA TISSUE

A soft, absorbent, economical one-ply tissue delivers excellent combination of performance and value. Each roll is overall wrapped, ensuring sanitary protection. Easy start tail seal prevents waste. Longer lasting rolls help to eliminate service outages. Rapid break-up capabilities is ideal for all plumbing systems. Made from 100% recycled fibers, providing environmental benefits. A positive image builder.

14101637	TS1636S	1-Ply, 1000 ct., 4 ⁷ / ₂₀ " Roll dia., 4" x 3 ³ / ₄ " Sheets, White	96/cs.
----------	---------	---	--------

• 14101640 is available in Canada Only. EcoLogo® Certified.

14101640	TS1639S	1-Ply, 1000 ct., 4 ⁷ / ₂₀ " Roll dia., 4" x 3 ³ / ₄ " Sheets, White	48/cs.
----------	---------	---	--------



JUMBO TISSUE



F. GREEN SOURCE™ JUMBO TOILET TISSUE

PRIME SOURCE®

100% recycled. Chlorine-free. EcoLogo® Certified. Trilingual packaging (English, Spanish, French).

75009505	75009505	3 ³ / ₁₁ " x 550', 2-Ply	12/cs.
----------	----------	--	--------

G. SCOTT® 100% RF JRT JR. BATHROOM TISSUE

KIMBERLY-CLARK

Made with 100% recycled fiber. Meets EPA standards for 40% minimum post-consumer waste content. Green Seal™ Certified.

15406722	67223	1-Ply, White, 3.55" x 2000'	12/cs.
----------	-------	-----------------------------	--------

15406780	67805	2-Ply, White, 3.55" x 1000'	12/cs.
----------	-------	-----------------------------	--------



30 GS

Jumbo Tissue/Facial Tissue/Roll Towels



A. TORK® ADVANCED MINI JUMBO ROLL BATH TISSUE SCA TISSUE

High capacity provides fewer refills and reduces labor. Large size is pilfer proof, hard to conceal. Can't use at home. Reduced stub roll means less waste. Fewer cores and no wrappers leads to source reduction. Less storage space is needed. Perforated. Rapid break-up capability is ideal for all plumbing systems. Made from 100% recycled fiber provides environmental benefits. A positive image builder. EcoLogo® Certified.

14103902 12013903 1-Ply, T2 System, 3.6" x 1200' 12/cs.



B. TORK® ADVANCED JUMBO BATH TISSUE SCA TISSUE

High capacity provides fewer refills and reduces labor. Large size is pilfer proof, hard to conceal and can't use at home. Reduced stub roll means less waste. Fewer cores and no wrappers leads to source reduction. Less storage space is needed. Perforated. Made from 100% recycled fiber. Provides environmental benefits. A positive image builder.

Environmental Choice EcoLogo® Certified.

14100055 11010402 T1 Refill, 10" dia., 3.6" x 2247', 1-Ply 6/cs.

Quality jumbo toilet tissue. 100% recycled, EcoLogo® Certified.

14100920 TJ0921A 2-Ply, 3³/₁₀" Core dia., 3⁵/₈" x 1000', White 12/cs.



C. TORK® UNIVERSAL JUMBO ROLL BATH TISSUE SCA TISSUE

Soft, absorbent tissue delivers quality, value and performance. Rapid break-up capability. Core is designed to fit virtually all size jumbo tissue dispensers. Smaller case cubes free up about 40% more storage space vs. conventional rolls. Made from 100% recycled fibers.

EcoLogo® Certified.

14100914 TJ0912A 1-Ply, 3³/₁₀" Core dia., 3⁵/₈" x 2000', 8⁴/₈" Roll dia., White 12/cs.

14101214 TJ1212A 1-Ply, 3³/₁₀" Core dia., 3⁵/₈" x 4000', 11³/₄" Roll dia., White 6/cs.



FACIAL TISSUE

D. SCOTT® 100% RF SURPASS BOUTIQUE FACIAL TISSUE KIMBERLY-CLARK

Made with 100% recycled fiber. Meets EPA standards for 40% minimum post-consumer waste content. Green Seal™ Certified.

15401295 21295 2-Ply, 110 ct., White, 8" x 8.3", Cube 3960/cs.

15401285 21285 2-Ply, 125 ct., White, 8" x 8.3", Flat 60/125/cs.



E. TORK® ADVANCED FACIAL TISSUE SCA TISSUE

Extra soft and absorbent two-ply facial tissue offers the right combination of performance and value. Soft shield protects the tissues and provides easy, one-at-a-time dispensing. The flat box style is ideal for the vanity or in-wall dispensers. Made from 100% recycled fibers, helps conserve natural resources. Dispenser box is manufactured from 100% recycled materials with a minimum of 15% post consumer materials.

14106811 TF6810 2-Ply, 100 ct., 8¹/₅"W x 7⁷/₁₀"L Sheets, White 30/cs.



F. TORK® UNIVERSAL FACIAL TISSUE SCA TISSUE

Soft and absorbent two-ply facial tissue offers the right combination of performance and value. The flat box style is ideal for the vanity or in-wall dispensers. Made from 100% recycled fibers, helps conserve natural resources. Dispenser box is manufactured from 100% recycled materials with a minimum of 15% post consumer materials.

14106710 TF6710A 2-Ply, 100 ct., 8¹/₅"W x 7⁷/₁₀"L Sheets, White 3000/cs.



ROLL TOWELS

G. GREEN SOURCE™ ROLL TOWELS PRIME SOURCE®

100% recycled. Chlorine-free. EcoLogo® Certified. Trilingual packaging (English, Spanish, French).

75009520 75009520 7³/₄" x 300', White, Standard 12/cs.

75009525 75009525 7³/₄" x 300', Natural, Standard 12/cs.

75009530 75009530 7³/₄" x 700', White, Jumbo 6/cs.

75009535 75009535 7³/₄" x 700', Natural, Jumbo 6/cs.



GREEN

Roll Towels/Center Pull Towels



A. HI-VALU ROLL TOWELS HI-VALU

Universal roll towels are high quality and value priced. Ideal for all public environments.

73004334	<i>73004334</i>	Natural, 7 ³ / ₄ " x 600'	96/cs.
73004333	<i>73004333</i>	White, 7 ³ / ₄ " x 600'	12/cs.

B. SCOTT® 100% RF HARD ROLL TOWELS KIMBERLY-CLARK

Made with 100% recycled fiber. Meets EPA standards for 40% minimum post-consumer waste content. Green Seal™ Certified.

15401052	<i>01052</i>	1-Ply, White, 8" x 800'	12/cs.
15402031	<i>02031</i>	1-Ply, Natural, 8" x 800'	12/cs.

C. TORK® ADVANCED HARDWOUND ROLL TOWELS SCA TISSUE

Roll towels are soft, strong and highly absorbent and offer the perfect combination of quality, performance and value. Embossing enhances hand feel and maximizes absorbency. Fewer towels are used per hand dry. Towels are made from 100% recycled fiber. EcoLogo® Certified.

14101350	<i>RB350A</i>	7 ⁷ / ₈ " x 350'	12/cs.
14100600	<i>RB600</i>	7 ⁷ / ₈ " x 600'	12/cs.
14100800	<i>RB800</i>	7 ⁷ / ₈ " x 800'	6/cs.

D. TORK® UNIVERSAL HAND ROLL TOWELS SCA TISSUE

Soft, strong, and highly absorbent Tork® roll towels offer the perfect combination of quality, performance, and value. Towels are made from 100% recycled fiber. EcoLogo® and Green Seal™ Certified.

14100488	<i>290088</i>	1-Ply, 7.8" x 700', Natural	6/cs.
-----------------	---------------	-----------------------------	-------

Ultra soft, ultra absorbent design. Deep embossing enhances hand feel and maximizes absorbency, fewer towels used per hand dry. Long lasting rolls minimize maintenance costs while maximizing service. Towels are made from 100% recycled fiber and 40% post consumer fiber. EcoLogo® and Green Seal™ Certified.

14100050	<i>RB425</i>	7 ⁷ / ₈ " x 425', White	12/cs.
-----------------	--------------	---	--------

E. TORK® UNIVERSAL HARDWOUND ROLL TOWELS SCA TISSUE

Soft, strong, and highly absorbent offering the perfect combination of quality, performance, and value. Embossing enhances hand feel and maximizes absorbency, fewer towels used per hand dry. Roll towel performance provides source reduction and less packaging. Long lasting rolls minimize maintenance costs while maximizing service. Towels are made from 100% recycled fiber. EcoLogo® Certified.

14100351	<i>RB351</i>	1-Ply, 7 ⁷ / ₈ " x 350', White	12/cs.
14106002	<i>RB6002</i>	1-Ply, 7 ⁷ / ₈ " x 600', White	12/cs.
14100104	<i>RK206E</i>	1-Ply, 7 ⁷ / ₈ " x 206', Natural	24/cs.
14101351	<i>RK350A</i>	1-Ply, 7 ⁷ / ₈ " x 350', Natural	12/cs.
14106000	<i>RK600E</i>	1-Ply, 7 ⁷ / ₈ " x 600', Natural	12/cs.
14100103	<i>RK800E</i>	1-Ply, 7 ⁷ / ₈ " x 800', Natural	6/cs.

CENTER PULL TOWELS

F. TORK® ADVANCED CENTERFEED HAND TOWELS SCA TISSUE

Offer one-at-a-time service and reduced waste. High capacity reduces labor and refills. High absorbency means fewer towels used. Touch only dispensing towel reduces cross contamination. Made from 100% recycled fiber. Provides environmental benefits. A positive image builder. EcoLogo® Certified. Compostable Verified by Independent Verification.

14100133	<i>120133</i>	1-Ply, 1000 ct., 8 ¹ / ₄ " x 11 ¹ / ₅ " Sheets, 983', 7 ⁷ / ₅ " Roll dia., 2 ⁹ / ₁₀ " Core dia., White	6/cs.
14100385	<i>121225</i>	2-Ply, 266 ct., Mini, 8 ³ / ₁₀ " x 11 ¹ / ₅ " Sheets, 262', 5 ¹ / ₂ " Roll dia., 2 ⁹ / ₁₀ " Core dia., White	12/cs.
14101230	<i>121201</i>	2-Ply, 600 ct., 9" x 11 ¹ / ₅ " Sheets, 590', 7 ⁷ / ₅ " Roll dia., 2 ⁹ / ₁₀ " Core dia., White	6/cs.
14100134	<i>121202</i>	2-Ply, 610 ct., 8 ¹ / ₄ " x 11 ¹ / ₅ " Sheets, 600', 7 ⁷ / ₅ " Roll dia., 2 ⁹ / ₁₀ " Core dia., White	6/cs.



Center Pull, Kitchen & C-Fold Towels



A. TORK® ADVANCED WATER TIGHT CENTERFEED HAND TOWELS SCA TISSUE

Offers these advantages. High capacity—ideal for high traffic environments. Hygienic—you only touch the towel you use...no cross-contamination from levers or cranks. Portion control—one towel every time. One hand dispensing—ideal for many environments such as workshops and kitchens. Multipurpose—highly absorbent towels for hands, surfaces and objects. Simple and reliable—low maintenance costs. Made from 100% recycled fiber. Provides environmental benefits. A positive image builder. EcoLogo® Certified. Compostable Verified by Independent Verification. Replaces 120110.

14100105 121211 2-Ply, 600 ct., 7¹/₁₀" x 11¹/₅" Sheets, 590', 6/cs.
7¹/₅" Roll dia., 2³/₁₀" Core dia., White

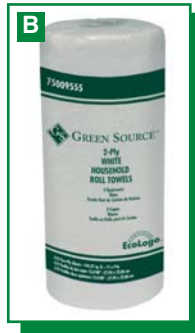

KITCHEN TOWELS

B. GREEN SOURCE™ KITCHEN ROLL TOWELS PRIME SOURCE®

100% recycled. Chlorine-free. EcoLogo® Certified. Trilingual packaging (English, Spanish, French).

75009555 75009555 2-Ply, 11", 210 ct., White 12/cs.



C. TORK® ADVANCED PERFORATED ROLL TOWELS SCA TISSUE

Tork Advanced perforated roll towels have high-bulk, two-ply construction that maximizes absorbency for superior spill holding power using fewer towels. Super strong soft towels hold together even on tough jobs. Ideal for cleaning and wiping all surfaces. Made from 100% recycled fibers has environmental benefits and is a positive image builder. EcoLogo® Certified.

14100107 HB9201 2-Ply, 120 ct., 5¹/₅" Roll dia., 11"W x 6³/₄"L, White 30/cs.

D. TORK® UNIVERSAL KITCHEN ROLL TOWELS SCA TISSUE

Tork Universal perforated roll towels have high-bulk, two-ply construction that maximizes absorbency for superior spill holding power using fewer towels. Super strong soft towels hold together even on tough jobs. Ideal for cleaning and wiping all surfaces. 210 count gives you twice the toweling, reducing replacement time, helps eliminate run-out and saves storage and delivery costs. Made from 100% recycled and meets the EPA compliant (minimum 90% post consumer content) providing environmental benefits. A positive image builder. EcoLogo® and Green Seal™ Certified.

14101975 HK1975A 2-Ply, 210 ct., 11" x 9", Natural 12/cs.



C-FOLD TOWELS

E. HI-VALU C-FOLD TOWELS HI-VALU

High quality and value priced. Ideal for all public environments.

73004304 73004304 150 ct., 10¹/₄" x 13" 2400/cs.

F. SCOTT® 100% RF C-FOLD TOWELS KIMBERLY-CLARK

Made with 100% recycled fiber. Meets EPA standards for 40% minimum post-consumer waste content. Green Seal™ Certified.

15402921 02920 1-Ply, 200 ct., White, 10¹/₁₀" x 13¹/₅" 2400/cs.



G. TORK® ADVANCED C-FOLD TOWELS SCA TISSUE

Soft and absorbent towels offer the perfect combination of quality, performance and value. Embossing enhances hand feel and maximum absorbency. High wet strength designed to please your most demanding users. Improved product design helps to control usage, so you save on reduced waste and maintenance time. Made from 100% recycled fiber. Provides environmental benefits. A positive image builder. EcoLogo® Certified. Compostable Verified by Independent Verification.

14100700 CB520 1-Ply, 150 ct., 12.8" x 10.1", White 2400/cs.



GREEN



C-Fold & Multifold Towels



A. TORK® PREMIUM C-FOLD TOWELS SCA TISSUE

Soft and absorbent C-fold towels offer the perfect combination of quality, performance and value. High wet strength designed to please your most demanding users. Improved product design helps to control usage, so you save on reduced waste and maintenance time.

Replaces CB540A.

14101540 CB510 125 ct., 12³/₄" x 10¹/₈", 3¹³/₂₀" x 10¹/₈" Folded, White 2400/cs.



B. TORK® UNIVERSAL C-FOLD TOWELS SCA TISSUE

Soft and absorbent towels offer the perfect combination of quality, performance and value. Embossing enhances hand feel and maximum absorbency. High wet strength designed to please your most demanding users. Improved product design helps to control usage, so you save on reduced waste and maintenance time. Made from 100% recycled fiber. Provides environmental benefits. A positive image builder. EcoLogo® Certified. Compostable Verified by Independent Verification.

14100706 CB530 150 ct., 12³/₄" x 10¹/₈", 3¹³/₂₀" x 10¹/₈" Folded, White, EcoLogo® 2400/cs.



MULTIFOLD TOWELS

C. GREEN SOURCE™ MULTIFOLD TOWELS PRIME SOURCE®

100% recycled. Chlorine-free. EcoLogo® Certified. Trilingual packaging (English, Spanish, French).

75009510 75009510 8¹/₈" x 9¹/₂", White, 1-Ply 4000/cs.
75009515 75009515 8¹/₈" x 9¹/₂", Natural, 1-Ply 4000/cs.



D. HI-VALU MULTIFOLD TOWELS HI-VALU

Universal paper towel are high quality and value priced. Ideal for all public environments.

73004306 73004306 200 ct., 9¹/₄" x 9¹/₂", White 4000/cs.
73004307 73004307 200 ct., 9¹/₄" x 9¹/₂", Natural 4000/cs.



E. SCOTT® 100% RF MULTIFOLD TOWELS KIMBERLY-CLARK

Made with 100% recycled fiber. Meets EPA standards for 40% minimum post-consumer waste content. Green Seal™ Certified.

15401801 01801 1-Ply, 250 ct., Natural, 9¹/₈" x 9²/₅" 4000/cs.
15401807 01807 1-Ply, 250 ct., White, 9¹/₈" x 9²/₅" 4000/cs.



F. TORK® ADVANCED INTERFOLDED TOWELS SCA TISSUE

The unique three panel interfolded system, creates ready-to-use towels with no towel "Fall Out". Portion control, delivers one towel every time. Tork Advanced Xpress™ towels are easy to refill, reducing maintenance time and costs. Towels are made from 100% recycled fibers (EPA compliant) providing environmental benefits. A positive image builder. EcoLogo® Certified.

14101291 101291 144 ct., 8⁹/₁₀" x 10", 8⁹/₁₀" x 3³/₈" Folded, EcoLogo® 3024/cs.



G. TORK® ADVANCED MULTIFOLD TOWELS SCA TISSUE

Embossing enhances hand feel and maximum performance. Made from 100% recycled fibers. High wet strength. Fast absorbency. "No touch" hand towel service offers sanitary conditions. Made from 100% recycled fibers, providing environmental benefits. A positive image builder. EcoLogo® Certified. Replaces MB550.

14100551 MB550A 250 ct., 9¹/₂" x 9¹/₈", White 4000/cs.

Multifold design provides for less towel consumption leading to source reduction, storage space savings, and lower overall costs. Deep embossing enhances hand feel and maximum absorbency. Excellent wet strength. Speedy absorbency. "No touch" hand towel service offers sanitary conditions. Towels are made from 100% recycled fibers and 40% post consumer fibers providing environmental benefits. A positive image builder. Replaces MB560. EcoLogo® Certified.

14100550 MB560A 150 ct., 9¹/₂" x 9¹/₈", 3¹/₅" x 9¹/₈" Folded, White, EcoLogo®, Green Seal™ 2400/cs.

Folded Towels/Feminine Hygiene/Seat Covers/Dusters



A. TORK® UNIVERSAL MULTIFOLD TOWELS SCA TISSUE

Innovative towel service surpasses all other folded towel services in performance, value, and economy. Multifold design helps to minimize towel usage. Towels are made from 100% recycled fibers. EcoLogo® Certified. Folded size: 3 1/5".

14100553	<i>MK518A</i>	250 ct., 9 1/2" x 8 1/10", Natural, Green Seal™	4000/cs.
14100538	<i>MB540A</i>	250 ct., 9 1/2" x 9 1/8", White	4000/cs.
14100520	<i>MK520A</i>	250 ct., 9 1/2" x 9 1/8", Natural, Green Seal™	4000/cs.

Soft and absorbent towels provide the right combination of quality, performance and value. Embossing enhances hand feel and maximum performance. Made from 100% recycled fibers. EcoLogo® Certified.

14100552	<i>MK530A</i>	250 ct., 9 1/2" x 9 1/8", Natural	4000/cs.
-----------------	---------------	-----------------------------------	----------



SINGLEFOLD TOWELS

B. TORK® UNIVERSAL SINGLEFOLD TOWELS SCA TISSUE

Soft, strong and highly absorbent. Embossing enhances hand feel and maximum performance. Singlefold design provides quality and fits all standard singlefold towel dispensers. Second fold creates a second 1/2" tab to aid dispensing. Towels are made from 100% recycled fibers. EcoLogo® Certified.

14101841	<i>SB1840A</i>	250 ct., 10 1/4" x 9 1/4", White	4000/cs.
14101855	<i>SK1850A</i>	250 ct., 10 1/4" x 9 1/8", Natural	4000/cs.



FEMININE HYGIENE

C. ENVIRO GARDS® ULTRA THIN MAXI PADS HOSPECO

A super absorbent sanitary napkin that is both flushable and biodegradable. Specially engineered, patented materials combine to make the only flushable and biodegradable sanitary napkin available for restroom feminine hygiene vending.

14502004	<i>EG4</i>	#4 Box	125/cs.
-----------------	------------	--------	---------



D. PAPER LINER HOSPECO

Kraft waxed paper liners. With gusset-wax finish. Fit Sanisac and #250, #201W, #ND1W, #ND1E receptacles. 100% recycled post-consumer waste.

14502200	<i>260</i>	10 1/4" x 7 1/2" x 3 1/2"	900/cs.
-----------------	------------	---------------------------	---------

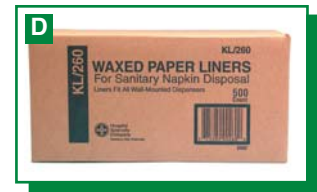

TOILET SEAT COVERS

E. HEALTH GARDS® TOILET SEAT COVER REFILLS HOSPECO

For environmentally concerned customers. Made from 100% recycled paper. Disposable and flushable.

14505001	<i>GREEN5000</i>	1/2 Fold, 250 ct., Green	5000/cs.
-----------------	------------------	--------------------------	----------



MICROFIBER DUSTERS

F. GLASSIC™ MICROFIBER CLOTHS CCP

Perfect for cleaning soap, grease or fingerprints from windows, mirrors and polished metal surfaces. Leaves a streak-free finish. Can be laundered five times more than 100% cotton towels.

27600228	<i>E222022</i>	10" x 7", Green, Mitt	12/cs.
27602222	<i>E850016</i>	16" x 16", Light Blue, Cloth	12/cs.



G. MICROFLEX™ DUSTERS CCP

Flexible, thin foam frame allows for effective cleaning in tight, hard-to-reach areas. Frame accepts a hand held handle or either one of our Pro Flat mop handles for high area cleaning. Microfiber refill for durability and long product life. Simply rinse away dirt with water after every use. Duster refills available separately.

27606025	<i>E224000</i>	2" x 27", Complete	1/ea.
27602907	<i>E224100</i>	2" x 22", Refills	3/cs.



GREEN

Dusters/Dust Mop Frames/Mops & Handles



A. SUPREMO™ MICROFIBER CLOTHS CCP

Highest quality microfiber available. A 45-50 gram all purpose cleaning cloth that contains 70% polyester and 30% polyamide. Great for dusting and cleaning all types of surfaces.

27602211	E800016	16" x 16", Green	12/cs.
27602210	E810016	16" x 16", Light Blue	12/cs.

B. WYPALL® MICROFIBER CLOTHS KIMBERLY-CLARK

Microfiber cloths with Microban® protection are durable, remarkably absorbent, and environmentally friendly. No chemicals needed. Cleans virtually any surface; wet, dry, or damp. Absorbs eight times its weight in liquid. Can be laundered 300 times. Color-coding helps reduce cross-contamination.

15403620	83620	15 ³ / ₄ " x 15 ³ / ₄ ", Blue	24/cs.
15403630	83630	15 ³ / ₄ " x 15 ³ / ₄ ", Green	24/cs.
15403980	83980	15 ³ / ₄ " x 15 ³ / ₄ ", Red	24/cs.
15403610	83610	15 ³ / ₄ " x 15 ³ / ₄ ", Yellow	24/cs.



DUST MOP FRAMES

C. PRO II™ FLAT MOP FRAMES CCP

Lightweight design allows for dramatic improvements in labor productivity. Trapezoid head effectively cleans corners and edges. 360° swivel attachment for maneuvering in tight areas. Handle locking clip to secure handle to frame connector. Designed to complement our line of microfiber refills.

276071701	C717018	4 ³ / ₄ " x 18", Blue/Silver	1/ea.
276071711	C717024	4 ³ / ₄ " x 26", Blue/Silver	1/ea.
27607171	C717024	4 ³ / ₄ " x 26", Blue/Silver	10/cs.



CUT MOP HEAD

D. ROUGH RIDER™ CUT-END MOP HEAD CCP

Cotton strands provide good absorption in this economical cut-end mop. Knitted material gives this mop much more strength than other cut-end mops.

27602213	A42213	1 ¹ / ₄ " Band, Large	12/cs.
----------	--------	---	--------



MOP HANDLE

E. PRO™ FLAT MOP HANDLE CCP

Made of lightweight, long-lasting aluminum that will not rust or corrode. Twist lock mechanism allows extendable handle to adjust from 39" to 60".

276071401	C714000	39" to 60"	1/ea.
27607140	C714000	39" to 60"	10/cs.



MICROFIBER MOPS

F. ERGOWORX™ TOUCHLESS MICROTEK CLEANING SYSTEM CCP

Designed to fit all of the most popular plastic and stainless steel janitorial carts made. Solution and discharge buckets are made from Derma-Tek™ non-porous plastic. Auto-discharge mop frame is made from glass-filled nylon. Completely non-ferrous; safe for use in areas with MRI equipment, will not rust or corrode. System includes: one solution bucket with perforated screen, one discharge bucket with aluminum discharge rod and one auto-discharge microfiber mop frame. 3" non-marking, all-swivel casters, ideal for tight hallways and small rooms. MFT-5 designed to accommodate common cleaning tools including a wet floor sign, microflex duster, wipes and RTU trigger sprayer bottles.

27605050	SYS5	22" x 19 ⁷ / ₈ " x 11 ⁵ / ₈ ", Complete System	1/ea.
276050511	SB5YW	22" x 8" x 11 ¹ / ₈ ", Discharge Bucket w/Aluminum Discharge Rod	1/ea.
276012001	MF5BK	18" x 5 ⁵ / ₈ " x 1 ³ / ₄ ", Auto-Discharge Mop Frame, Black	1/ea.
27605052	MFT5BK	31 ³ / ₄ " x 23" x 38 ¹ / ₂ ", Trolley, Black	1/ea.



Microfiber Mops/Mop Buckets/Wringers/Can Liners



A. SUPER PRO FINISH MOP MICROFIBER REFILL CCP

Microfiber finish flat mop is looped end and constructed of high-wet modulus rayon blend yarn that provides quick, controlled liquid release. The finish flat mop will cover a 20" wide swath. Unlike conventional finish mops, 100% of the floor finish goes onto the floor along with full contact of the refill to the surface allowing better productivity and less chemical wasted in the mop. Should be rinsed after every use.

27602980 C106020 5" x 20", Light Blue 6/cs.



B. SUPER PRO II™ MICROFIBER REFILLS CCP

Looped-end construction and durable Microfiber provide long product life. Made of 100% Microfiber, it can be laundered 300 to 500 times, when cared for properly. Perma-Stitch sewn border is extremely durable. Hook and loop attachment for easy installation and removal from frame. Can be used for damp or dry mopping.

27602991 C103020 5" x 20", Blue 10/cs.
27602992 C103026 5" x 26", Blue 10/cs.
27602996 C104020 5" x 20", Red 10/cs.
27602997 C104026 5" x 26", Red 10/cs.
27602995 C107020 5" x 20", Yellow 10/cs.
27602998 C108020 5" x 20", Green 10/cs.

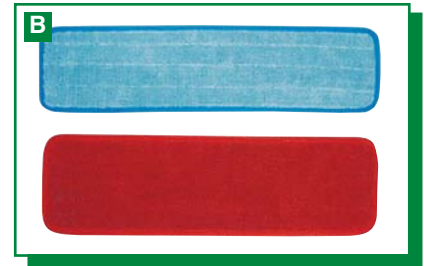

C. THE AGGRESSOR™ MICROFIBER SCRUBBING REFILL CCP

Innovative combination of microfiber yarn and synthetic stiff brush fibers. Designed to remove debris stuck to the floor that normal "yarn only" microfiber flat mops cannot.

276001261 C109020 5" x 20", Blue/White 1/ea.
27600126 C109020 5" x 20", Blue/White 10/cs.

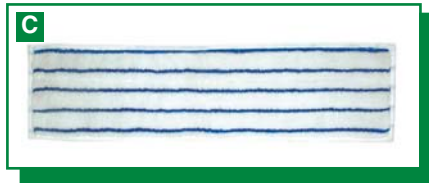

MOP BUCKETS & WRINGERS

D. WAVEBRAKE® MOP BUCKET RUBBERMAID

The WaveBrake® mop bucket reduces splashing, which means a safer environment, cleaner floors, and improved productivity.

177075661 757088BLUE 35 qt., Blue 1/ea.



E. WAVEBRAKE® SIDE PRESS COMBO RUBBERMAID

The WaveBrake® mop bucket and wringer system reduces splashing, which means a safer environment, cleaner floors and improved productivity. High efficiency side press wringer. Lasts 58 times longer than comparative wringers. Tested to exceed 50,000 wringing cycles, average wringers perform approximately 860 cycles. Premium tubular steel and structural web molded plastic.

17707602 758888BLUE 35 qt., Blue 1/ea.



CAN LINERS

F. COMP-LETE™ COMPOSTABLE BAGS FORTUNE PLASTICS

Offer superior strength and compostability. BPI's "Compostable Logo" is awarded to products that meet ASTM D6400, assuring end users and composters that the bags will biodegrade swiftly and safely during municipal, commercial, or household composting. Will not leave plastic residues in the finished compost. Made from Mater Bi™ material. Ideal for collecting food scraps and yard trimmings for composting. Replacing non-degradable trash bags with compostable ones helps composters reduce processing, separation, and disposal costs while keeping consumers collection bins clean, which encourages participation.

13800092 BIO3980R 33 gal., 30" x 39", Natural, 0.80 MIL, 250/cs.
 Use for Food Scraps
13800088 BIO4685R 40-45 gal., 40" x 46", Natural, 0.85 MIL, 200/cs.
 Use for Yard Waste



GREEN

Can Liners/Wastebaskets/Trash Containers



A. BIOTUF™ COMPOSTABLE BAGS

HERITAGE BAG

Tough on trash, easy on the environment. Superior strength designed for pre- and post-consumer food waste diversion programs. Excellent puncture and tear resistance. Proven lifting strength and load capacity. Odor control, dissipates moisture. 100% biodegradable and compostable. Photodegrades if left by roadside. 100% ASTM D6400 certified degradable, 100% compostable. Light green in color.

38996649	<i>Y6039SER01</i>	30 gal., 30" x 39", Super Heavy, 1.2 MIL	125/cs.
38996650	<i>Y6848YER01</i>	32 gal., 34" x 48", X-Heavy, 1 MIL	100/cs.
38996651	<i>Y8448YER01</i>	48 gal., 42" x 48", X-Heavy, 1 MIL	100/cs.
38996652	<i>Y9460YER01</i>	64 gal., 47" x 60", X-Heavy, 1 MIL	100/cs.



B. NATURE FRIENDLY® TRASH BAGS NATURE FRIENDLY PRODUCTS

Nature Friendly Products' trash bags and liners are designed to meet the requirements of the food service industry and protect the environment. They are fully compostable and biodegradable in approximately 50-100 days in properly maintained compost facilities. These products are made from a polyester-based proprietary resin that is fully certified biodegradable and compostable, meeting the ASTM D6400 Standards for Compostability. They are superior in quality, strength and performance, BPI approved, and non-toxic.

C6937003	<i>G105</i>	55 gal., Large, 0.9 MIL	100/cs.
C6937007	<i>G106</i>	69 gal., Large, 0.9 MIL	80/cs.



WASTEBASKETS/TRASH CONTAINERS

C. DESKSIDE RECYCLING CONTAINERS

RUBBERMAID

An easy and effective way to recycle paper. Contains Post-Consumer Recycled Resin (PCR) exceeding EPA guidelines. Designed to be used in systems with existing office containers and accessories.

177029551	<i>295573</i>	Small, 13 ⁵ / ₈ qt., Blue	1/ea.
177008141	<i>295673</i>	Medium, 28 qt., Blue	1/ea.
177029571	<i>295773</i>	Large, 41 ¹ / ₄ qt., Blue	1/ea.



D. PAPER RECYCLING CONTAINER

RUBBERMAID

Deskside paper recycling system is designed to be used with existing office containers and accessories, Rubbermaid's office paper recycling system is an easy and effective way to collect waste paper. For use in areas of high paper generation, such as near copiers, printers and in mailrooms. Serves as a convenient central collection site for multiple work stations.

177080011	<i>356806</i>	19 gal., 14 ¹ / ₂ " sq. x 24"H, Blue	1/ea.
------------------	---------------	--	-------



E. HALF ROUND RECYCLING CONTAINER

RUBBERMAID

For use in areas of high paper generation, such as near copiers, printers and in mailrooms. Station containers serve as a convenient central collection site for multiple work stations. Recommended for indoor and outdoor use. Large capacity ideal for heavy traffic areas. Designed to withstand extreme weather and handling.

177035211	<i>352006BLUE</i>	21 gal., Blue	1/ea.
------------------	-------------------	---------------	-------



F. SLIM JIM® WASTE CONTAINER

RUBBERMAID

Efficient size and shape fits tight spaces. Durable, all-plastic construction is easy to clean and provides long life. All Slim Jim® tops fit on all Slim Jim® containers.

177040061	<i>3540DBLUE</i>	23 gal., Dark Blue	1/ea.
------------------	------------------	--------------------	-------

G. SLIM JIM® PAPER RECYCLING TOP

RUBBERMAID

Promote recycling and improve productivity. Interchangeable, color-coded tops promote waste separation: slotted blue top for paper; green, blue and brown round-hole tops for glass bottles, jars and metal cans; gray handle tops for general refuse. All tops fit on 3540, 3541, 3554 containers.

177027031	<i>270388BLUE</i>	20 ¹ / ₂ " x 11 ¹ / ₂ " x 2 ³ / ₄ ", Dark Blue	1/ea.
------------------	-------------------	--	-------



GREEN

Wastebaskets/Trash Containers



A. SLIM JIM® SWING LIDS RUBBERMAID

Promote recycling and improve productivity. Swing top provides easy access for trash disposal and then swings back to hide trash from public view. Encourage waste separation and recycling with interchangeable, color-coded tops.

177077881 267360BRN Brown 1/ea.
177026711 267360DBLUE Dark Blue 1/ea.



B. UNTOUCHABLE® SQUARE RECYCLING CONTAINER RUBBERMAID

For use in high-volume areas. Sleek design for a professional image. Contains Post-Consumer Recycled Resin (PCR) exceeding EPA guidelines. Patent Pending can liner cinch allows for bag retention and eliminates knot tying. Station containers provide convenient central collection sites for multiple work stations or areas. All containers come standard with the universal recycle symbol imprint.

177035691 356973 23 gal., Blue 1/ea.



C. UNTOUCHABLE® BOTTLE & CAN RECYCLING TOP RUBBERMAID

Fits 3958-06 and 3959-06 containers. For use in areas of high paper generation, such as near copiers, printers and in mailrooms. Station containers serve as a convenient central collection site for multiple work stations. Recommended for indoor and outdoor use. Large capacity ideal for heavy traffic areas. Perfect for large crowds and high-traffic areas. Designed to withstand extreme weather and handling.

177027911 2791 20 1/8" sq. x 6 1/4" H, Dark Blue 1/ea.



D. UNTOUCHABLE® PAPER RECYCLING TOP RUBBERMAID

Fits 3958-06 and 3959-06 containers. For use in areas of high paper generation, such as near copiers, printers and in mailrooms. Station containers serve as a convenient central collection site for multiple work stations. Recommended for indoor and outdoor use. Large capacity ideal for heavy traffic areas. Perfect for large crowds and high-traffic areas. Designed to withstand extreme weather and handling.

177059071 2794 20 1/8" sq. x 6 1/4" H, Dark Blue 1/ea.



E. SQUARE RECYCLING CONTAINERS RUBBERMAID

For use in areas of high paper generation. Contains Post-Consumer Recycled Resin (PCR) exceeding EPA guidelines. Station containers serve as a convenient central collection site for multiple work stations. Recommended for indoor and outdoor use. Large capacity ideal for large crowds and high-traffic areas. Designed to withstand extreme weather and handling.

177039551 395873 35 gal., 19 1/2" sq. x 27 5/8" H, Blue 1/ea.
177059051 395973 50 gal., 19 1/2" sq. x 34 1/4" H, Blue 1/ea.



F. BRUTE® ROUND CONTAINER RUBBERMAID

All plastic construction will not rust, chip or peel; resists dents. Strong, snap-on lids available for secure, stable stacking. Reinforced rims for added strength and durability. Built-in handles for easy, non-slip lifting; easy anti-jam nesting. Double-ribbed base for increased stability and dragging capacity. Lids and dolly sold separately.

177026211 2620DBLUE 20 gal., Dark Blue 1/ea.



G. BRUTE® MOBILE OFFICE PAPER COLLECTION CONTAINER RUBBERMAID

Can serve as central collection containers or shipping containers, reducing the amount of handling. Heavy-duty wheels roll easily, even over steps or curbing. Transport recyclable waste with ease and efficiency.

177026361 263406 32 gal., Blue 1/ea.



GREEN



Wastebaskets/Trash Containers/Matting

GREEN



A. BRUTE® RECYCLING CONTAINERS			RUBBERMAID
Recycling container without lid. Contains Post-Consumer Recycled Resin (PCR) exceeding EPA guidelines. Transport recyclable waste with ease and efficiency.			
177032061	263206	32 gal., Blue	1/ea.
177043061	264373	44 gal., Blue	1/ea.



B. BRUTE® SQUARE RECYCLING CONTAINER			RUBBERMAID
Contains Post-Consumer Recycled Resin (PCR) exceeding EPA guidelines. Can serve as central collection containers or shipping containers, reducing the amount of handling. Transport recyclable waste with ease and efficiency.			
177035371	353673	40 gal., 23 1/2" sq. x 28 3/4"H, Blue	1/ea.



C. PLAZA® RECYCLING CONTAINERS			RUBBERMAID
Large capacity recycling containers for any outdoor environment. Contains Post-Consumer Recycled Resin (PCR) exceeding EPA guidelines. Station containers serve as a convenient central collection site for multiple work stations. Recommended for indoor and outdoor use.			
Bottle & Can Recycling			
17700968	396873	50 gal., 24 3/4"L x 25 1/4"W x 42 1/8"H, Blue	1/ea.
Paper Recycling			
17700969	396973	50 gal., 25 3/4"L x 25 1/4"W x 42 1/8"H, Dark Blue	1/ea.



D. GLUTTON® RECYCLING CONTAINER			RUBBERMAID
Large capacity recycling containers for any outdoor environment. Contains Post-Consumer Recycled Resin (PCR) exceeding EPA guidelines. Station containers serve as a convenient central collection site for multiple work stations. Recommended for indoor and outdoor use. Perfect for large crowds and high-traffic areas. Designed to withstand extreme weather and handling. Accepts two Slim Jim® Containers (3540).			
177002641	256B73	56 gal., Blue	1/ea.



E. GLUTTON® BOTTLE & CAN RECYCLING TOP			RUBBERMAID
Fits large capacity recycling containers. Station containers serve as a convenient central collection site for multiple work stations. Recommended for indoor and outdoor use. Large capacity ideal for heavy traffic areas.			
17700258	256LDBLUE	Dark Blue, For 256B Containers, 26 5/8"L x 23"W x 13"H	1/ea.



MATTING

F. CLEAN STEP SCRAPER MATS			MILLENNIUM MAT
All-rubber mat ideal for any outside entryway. The superior molded tread aggressively scrapes shoes clean of dirt and grime and traps it into the base of the mat. Available in black only. Certified slip-resistant by the National Floor Safety Institute.			
C5440150	14030500	3' x 5', Black	1/ea.
C5440151	14040600	4' x 6', Black	1/ea.



G. ECOGUARD® INDOOR MATS			MILLENNIUM MAT
Made from 99% recycled material, EcoGuard is the most eco-friendly and ecologically responsible mat ever. Carpeted surface is made from 100% post-consumer PET plastic bottles. The all rubber backing is made from used tires, preventing landfill waste.			
C5440200	EG020304	2' x 3', Charcoal	1/ea.
C5440201	EG030504	3' x 5', Charcoal	1/ea.
C5440202	EG031004	3' x 10', Charcoal	1/ea.
C5440203	EG040604	4' x 6', Charcoal	1/ea.



H. FLEX STEP ANTI-FATIGUE MATS			MILLENNIUM MAT
Reduces fatigue and discomfort while increasing productivity. Air domes offer flexible and comfortable support, and low-profile beveled edges reduce the risk of tripping. Accepted by the American Podiatric Medical Association. Certified slip-resistant by the National Floor Safety Institute.			
C5440300	24020300	2' x 3', Black	1/ea.
C5440301	24030500	3' x 5', Black	1/ea.

All Purpose Cleaners



ALL PURPOSE CLEANERS

A. PRIME SOURCE® ECONO PINE CLEANER PRIME SOURCE®

Provides economical cleaning. Rinse-free. Made from pure pine oil.
75004009 75004009 1 gal. 4/cs.



B. PRIME SOURCE® OXYGEN BLEACH CLEANSER PRIME SOURCE®

Calcite-based, non-chlorinated formula effectively cleans porcelain, ceramic tile, stainless steel fixtures and aluminum.
75004015 75004015 21 oz. 24/cs.



C. PRIME SOURCE® REFRESH PINE DEODORANT CLEANER PRIME SOURCE®

All purpose cleaner and deodorant that contains pine oil to provide outstanding deodorizing power.
75004017 75004017 1 gal. 4/cs.
75004018 75004018 5 gal. 1/ea.



D. PRIME SOURCE® TORNADO PLUS CITRUS CLEANER PRIME SOURCE®

Contains N.O.S. (sodium carbonate) for superior cleaning power.
76008504 76008504 3.78 L 4/cs.



E. PRIME SOURCE® ULTIMATE ALL PURPOSE CLEANER PRIME SOURCE®

Powerful cleaning action. Use on wood, metal and painted surfaces. Clean, fresh fragrance.
75004000 75004000 18 oz. Aerosol 12/cs.



F. PRIME SOURCE® ULTIMATE ALL PURPOSE CLEANER PRIME SOURCE®

Concentrated all purpose cleaner with moderate alkalinity that will not dull or remove floor finishes. Safe for most washable surfaces.
75004001 75004001 1 gal. 4/cs.
75004002 75004002 5 gal. 1/ea.



G. SUPERMARKET MIRACLE MULTI-SURFACE CLEANER & PROTECTOR PRIME SOURCE®

Protects surfaces from fingerprints and static electricity. For use on glass, Plexiglas®, mirrors, chrome, fiberglass, face shields and even computer monitors.
75004011 75004011 12 oz. Aerosol 12/cs.



H. ALL PURPOSE PINE CLEANER CARROLL

Formulated with emulsifiable pine oil. Effective cleaner with outstanding deodorizing power. Concentrated formula safe for use on most washable surfaces. Excellent pine fragrance.
30010143 34028 1 gal. 4/cs.



All Purpose Cleaners



A. ENVIROPATROL® CARROLL

Heavy-Duty Cleaner

High performance, extra strength heavy-duty cleaner and degreaser for the toughest of cleaning jobs, from the kitchen to the industrial plant. Replaces conventional kitchen and industrial cleaner/degreasers with an effective environmentally preferable alternative. Quickly removes petroleum-based soils. Use for spray-on and wipe-off cleaning, mop and bucket, automatic scrubbing, pressure washer or manual cleaning procedures. Dilutes at 1 oz./gal. (1:128) for most applications. This product is recognized by the U.S. Environmental Protection Agency Design for the Environment (DfE) Formulator Initiative for its improved environmental and human health characteristics. Cold water effective.

30011982 19828 1 gal. 4/cs.

Multi-Purpose Cleaner

Use as a high performance multi-surface cleaner, daily non-alkaline floor cleaner, scrub/recoat detergent, window cleaner, washroom cleaner, odor neutralizer, tile/grout cleaner and brightener and carpet care product. Dilutes at 1 oz./gal. (1:128) for most applications. This product is recognized by the U.S. Environmental Protection Agency Design for the Environment (DfE) Formulator Initiative for its improved environmental and human health characteristics. Cold water effective.

30018528 18528 1 gal. 4/cs.

Oxide:

Multi-surface cleaner, deodorizer and stain remover. Organic solvent derived from orange and citrus peels fortified with hydrogen peroxide creating a cleaning solution with unequaled ability to dissolve and emulsify soils of all types. Absolutely superior cleaning ability without the use of a petroleum solvent or glycol ethers (butyl cellosolve). It penetrates and emulsifies for easy removal of oils and soils from any washable surface. The hydrogen peroxide cleans stains and takes odor away - safely and instantly. Dilutes at 2 oz./gal. (1:64) for most applications. Cold water effective.

30010196 19623 1 qt. RTU 12/cs.

30010197 19628 1 gal. 4/cs.



B. UNO! MULTI USE CLEANER CARROLL

Neutral ph, no rinse cleaner. Water-based powerful formula, gently cleans soils from most surfaces. Concentrated, versatile, reduces need for several products. Long-lasting fresh lavender fragrance, pleasant to use. Free-rinsing, will not leave dulling soap film.

30010013 18928 1 gal. 4/cs.



C. PARSONS® AMMONIA ALL PURPOSE CLEANER CHURCH & DWIGHT

All purpose cleaner cleans floors, ceramic tiles, painted woodwork and even glass and mirrors without streaking.

A5165600 84856 1 gal. 4/cs.

A5160855 84856 1 gal. 12/cs.



D. FORMULA 409® ALL PURPOSE CLEANER CLOROX

Specially formulated to cut grease on contact. Easy-to-use - no mixing required.

38380628 00628 22 oz., Trigger Sprayer 12/cs.



E. GREEN WORKS® CLOROX

Naturally Derived All Purpose Cleaner

Powers through grease, grime, dirt and soils with 97% naturally derived ingredients. Safe to use on a wide variety of surfaces throughout kitchens and bathrooms, including stainless steel, sealed granite, chrome. Acknowledged by the U.S. EPA's Design for Environment Program.

38380456 00456 32 oz. 12/cs.

38380457 00457 64 oz., Refill 6/cs.

Naturally Derived Dilutable Cleaner

Works on grease, grime and dirt. Is safe on multiple surfaces throughout the kitchen and bathroom, including non-wood floors, counters, sinks, stoves, garbage cans and toilets. Performs as well or better than the leading conventional cleaners. Dilutable formula (concentrate). Recognized by the U.S. Environmental Protection Agency Design for the Environment (DfE) Formulator Initiative for its improved environmental and human health characteristics.

38380458 00458 64 oz. 6/cs.

All Purpose Cleaners



A. PINE-SOL® ALL PURPOSE CLEANERS CLOROX

Original

Distinctive scent and deep-down cleaning power. For use in: kitchens, bathrooms, and on tough jobs. EPA-Registered disinfectant kills germs while it cleans. Deodorizes and wipes out odor-causing bacteria. Economical cleaner with 1 oz. of concentrate per 64 oz. of water (at 1:64).

38387326	97326	24 oz.	12/cs.
38380174	40174	28 oz.	12/cs.
38380125	40125	48 oz.	8/cs.
38381773	41773	60 oz.	6/cs.
38385418	35418	144 oz.	3/cs.

Lavender Clean®

Pine-Sol scented all purpose cleaners deodorize and eliminate unpleasant odors. Cuts through tough grease and grime fast. Versatile enough to use on a wide variety of surfaces, including floors, counters and sinks.

38380240	40272	48 oz.	8/cs.
-----------------	-------	--------	-------

Lemon Fresh

Removes and cleans dirt, grease, scuffmarks, food and beverage stains, and mud stains without leaving a sticky residue. Deodorize and eliminate unpleasant odors. IPSOS Brand Equity Tracker 2009. Cuts through tough grease and grime fast. Deodorizes with preferred scent. Long-lasting scent. Versatile enough to use on a wide variety of surfaces, including floors, counters and sinks (use as directed on hard, nonporous surfaces).

38385419	35419	144 oz., Lemon Fresh	3/cs.
-----------------	-------	----------------------	-------

Orange Energy

Versatile all purpose cleaning and deodorizing. Removes and cleans dirt, grease, scuffmarks, food and beverage stains, and mud stains without leaving a sticky residue. Pine-Sol® Scented All Purpose Cleaners deodorize and eliminate unpleasant odors. Preferred over leading competitors, the powerful scent of clean lingers long after the job is done, assuring customers, guests and staff that it's clean. IPSOS Brand Equity Tracker 2009.

38388744	41772	144 oz.	3/cs.
-----------------	-------	---------	-------



B. AJAX® LIQUID CLEANERS COLGATE-PALMOLIVE

All Purpose Cleaner

Grease-cutting formula removes tough dirt and grease. Fresh lemon scent. Flip cap dispenser gives controlled application and dilution. Use on all floors, bathtubs, walls, toilets, sinks and countertops. Add 1/4 cup to 1 gal. of water.

11900019	41197	32 oz.	12/cs.
-----------------	-------	--------	--------

Ammonial™ All Purpose Cleaner

Ammonial cleaning power for use on most hard washable surfaces. No rinse formula. Contains biodegradable surfactants.

11908230	04949	1 gal.	4/cs.
-----------------	-------	--------	-------

Neutral Multi-Surface/Floor Cleaners

Excellent general purpose cleaner for hard, washable surfaces. Micro-emulsion technology formula penetrates deep into surfaces to suspend grease and soils for easy removal. All cleaning agents are biodegradable.

11901143	01143	2 oz. Packets	80/cs.
-----------------	-------	---------------	--------

11904944	04944	1 gal.	4/cs.
-----------------	-------	--------	-------

Ultra Neutral Multi-Surface/Floor Cleaner

Excellent general purpose cleaner for hard, washable surfaces. Micro-emulsion technology formula penetrates deep into surfaces to suspend grease and soils for easy removal. All cleaning agents are biodegradable. Super concentrated: 1 gal. makes up to 256 gal. of ready-to-use.

11900610	06010	1 gal., Super Concentrated	4/cs.
-----------------	-------	----------------------------	-------

Pine Forest

Pine-scented cleaner for general cleaning and deodorizing hard washable surfaces. Dual detergent system for greasy and particulate soils. All cleaning agents are biodegradable.

11908205	04209	1 gal.	4/cs.
-----------------	-------	--------	-------

Quik-Solv Spray Cleaner

Industrial strength solvent-based detergent cleaner. Removes tough soils and stains as well as baked on grease. No mixing required. Just spray and wipe. Versatile enough to use for most spot cleaning jobs. Safe for all hard surfaces. All cleaning agents are biodegradable.

11904164	74164	32 oz.	12/cs.
-----------------	-------	--------	--------



CHEMICALS

All Purpose Cleaners



A. AJAX® CREME CLEANSERS COLGATE-PALMOLIVE

Creme Cleanser

Cleans, deodorizes, kills odor causing bacteria. Liquid formula clings to vertical surfaces. Fresh lime scent. Free-rinsing, leaves no dulling film.

11904942 14942 40 oz. 9/cs.

Scouring Creme

No harsh abrasives. Fresh lemon scent. Perfect for modern surfaces; polishes and destains to keep surfaces looking new. Especially effective on vertical surfaces. DfE approved formula.

11901700 04941 24 1/2 oz. 9/cs.



B. AJAX® POWDERED CLEANSERS COLGATE-PALMOLIVE

Soft Cleanser

Contains chlorinating agents, detergents and grease cutters. Quickly removes greasy stains and soils. Mild calcite abrasives gently polish stains away safely.

11904290 14290 21 oz. 30/cs.

Oxygen Bleach Cleanser

Calcite-based, non-chlorinated formula. For use on porcelain, ceramic tile, stainless steel fixtures, and aluminum. Works well in tough cleaning situations where chlorine is undesirable.

11901460 04275 14 oz., Silica 48/cs.

Heavy-Duty Oxygen Bleach Cleanser

Non-chlorinated, economical cleanser for durable surfaces. The economical choice for general soils where chlorine or ammonia odors are undesirable.

11904278 14278 21 oz. 24/cs.



C. FABULOSO® ALL PURPOSE CLEANERS COLGATE-PALMOLIVE

Cleans and leaves a long-lasting fresh scent. Effective for a wide variety of cleaning applications. Advanced technology formula penetrates deep into surface to capture grease and soils. Neutral pH makes product safe for people and surfaces. No alkaline builder to leave a residue. No-rinsing step needed in floor cleaning applications. All cleaning agents are biodegradable. Bilingual labeling. DfE approved formula.

11900015 53046 32 oz., Lavender 9/cs.

11904307 04307 1 gal., Lavender 4/cs.

11904373 04373 1 gal., Ocean Cool 4/cs.



D. MURPHY® MULTI-USE WOOD CLEANER W/ORANGE OIL COLGATE-PALMOLIVE

Convenient ready-to-use all purpose formula with special cleaning agents to remove finger marks, crayon and grease. Pure vegetable oil soap; no dulling residue. Cleans finished wood and hard surfaces. Contains natural orange oil.

11901030 01030 22 oz., Trigger Sprayer 12/cs.



E. SOFT SCRUB® DIAL

Antibacterial Cleanser w/Bleach

Attacks tough cleaning jobs like grease, dirt, stains, mold, mildew and soap scum without damaging surfaces. Kills 99.9% of germs. Economical size with bilingual packaging. EPA registered.

12801602 01602 24 oz. 9/cs.

Commercial Cleanser w/Bleach

Soft Scrub® cleanser has superior surface safety, attacks grease and rinses clean. Formulated to protect surfaces and to minimize work and residue.

12805519 15519 36 oz. 6/cs.

Gel w/Bleach

Non-abrasive cleaner. Wipes away greasy dirt and soap scum. Can be used on most surfaces.

12801650 01650 17 oz. 9/cs.

Lemon Cleanser

Mild abrasive and versatile multipurpose cleanser that is tough on grease, dirt and soap scum without damaging surfaces. Fresh lemon scent.

12800865 00865 26 oz. 9/cs.

12805020 15020 38 oz. 6/cs.

All Purpose Cleaners



A. CREW® RTU EMEREL MULTI-SURFACE CRÈME CLEANSER DIVERSEY

Quickly removes stubborn spots, build-up, scuffs, grease, rubber marks, soap scum on porcelain, ceramic, stainless steel, chrome, Formica, fiberglass, and other surfaces.
15200414 4995295 32 oz., Fresh Floral 12/cs.



B. EASY PAKS® ALL PURPOSE CLEANER DIVERSEY

Concentrated powdered compound quickly effervesces in water to produce a cleaning dilution that can be varied to meet your needs. Specially-formulated to loosen and remove stubborn soils on virtually any hard surface. Multi-surface: Can be used on stainless steel, chrome, porcelain, ceramic tile, quarry tile, terrazzo, linoleum, marble, concrete, painted surfaces and vinyl. NSF C1 Registered.
15200154 90651 (90) 1/2 oz. 2/90/cs.



C. ENVY® MULTIPURPOSE CLEANER DIVERSEY

Non-scratching quaternary germicidal foam or ready-to-use liquid dissolves scum and soap film fast on sinks, fixtures and other washable surfaces. Simply spray and wipe for effective cleaning. EPA registered.
15207046 4531 19 oz. Aerosol 12/cs.



D. FANTASTIK® All Purpose Cleaner DIVERSEY

Ready-to-use for fast, effective cleaning on most washable surfaces. Removes stubborn stains including grease, scuff marks, pencil and crayon marks, smoke film and fingerprints. No rinsing required. Multi-surface: can be used on a variety of surfaces including exhaust fans, stove hoods, walls, ceramic tile, porcelain fixtures, bathtubs, plastic upholstery, cabinets, stainless steel, metal awnings, painted woodwork, chrome, appliances, sinks and showers.
15200504 2900504 32 oz., Capped Trigger Bottle 12/cs.
15202865 CB002862 32 oz., Trigger Sprayer - Antibacterial 12/cs.
15200046 94368 32 oz., Trigger Sprayer - Professional 12/cs.
15200047 94369 1 gal. 4/cs.
15200045 94366 5 gal., Bag-in-Box 1/ea.



All Purpose Cleaner w/Bleach
 Removes tough food stains and greasy soils in the kitchen. Removes soap scum, mold stains and mildew stains in the restroom. For use on most hard surfaces including; countertops, stovetops, sinks, appliances, tubs, showers, grout, tile, floors and toilets. Leaves a fresh, clean scent.
15200541 CB105686 32 oz. 12/cs.

Orange Action All Purpose Cleaner
 Tough cleaning action with pure orange oil. Cuts through tough grease and grime without leaving a smeary residue. Deodorizes multi-surfaces. Use on appliances, stainless steel, chrome, countertops, sinks, cabinets, ceramic tile, floors, basins, tubs, showers, fiberglass and porcelain surfaces.
15200187 CB182628 32 oz., Trigger Sprayer 12/cs.



E. GLANCE® NA GLASS & MULTI-PURPOSE CLEANER DIVERSEY

Non-streaking, quick-drying, non-ammoniated glass cleaner. Use on most washable surfaces, including chrome, stainless steel, bathroom fixtures and laminate countertops. Environmentally preferred. Reduced human and aquatic toxicity. Reduced smog production potential. Will not streak or smear glass, windows or mirrors. Wipes clean, dries fast. Blue in color.
15209510 5019510 1.4 L, SmartDose™ #2 2/cs.

F. MR. MUSCLE® CHLORINATED CLEANSER DIVERSEY

Cleans and deodorizes using mild abrasives like those found in more expensive soft liquid cleansers. Easily removes stains, corrosion and most soils from surfaces like tile, porcelain, metal, enamel and terrazzo.
15200032 91210 21 oz. 24/cs.



All Purpose Cleaners



A. PERDIEM™ GENERAL PURPOSE CLEANER W/HYDROGEN PEROXIDE DIVERSEY

A concentrated cleaner based on proprietary Accelerated Hydrogen Peroxide (AHP®) technology. This heavy-duty cleaner is safe on most hard surfaces, including marble floors. Multiple dilutions allow for cleaning a wide range of cleaning applications, including floors, walls, glass and other hard surfaces. Product can be used for carpet extraction, prespray and spotting. Contains no added dyes or fragrance. Use in autoscrubbers, mop and bucket and spray-and-wipe applications. Colorless and odorless.

15209481 5019481 1.4 L, SmartDose™ #58 2/cs.



B. SPITFIRE™ NB NON-BUTYL SPRAY & WIPE CLEANER DIVERSEY

High active formula quickly penetrates all types of grease and grime, simply spray and wipe clean. No rinsing required. Cleans graffiti, petroleum grease, food grease, animal fats, smudges, lipstick, black heel marks, smoke film, and ordinary soil films. Cleans without butyl solvents. Ready-to-use.

15204995 4995 32 oz. 12/cs.



C. SPITFIRE™ POWER CLEANER DIVERSEY

The super-strength formula eliminates grease, petroleum and food oils. This powerful cleaner works on the toughest dirt, grime or stains on a wide variety of surfaces and soils. Lightly scented and pleasant to use, the no-rinse formula leaves no residue.

15207961 3702 32 oz., RTU 12/cs.



D. STRIDE® ALL PURPOSE CLEANER DIVERSEY

Fresh floral fragrance. Use as an all purpose neutral cleaner for everyday floor cleaning and light-duty spray and wipe cleaning.

15204689 4689 1 gal., 1:32 - 1:64 4/cs.



E. WHISTLE® ALL PURPOSE CLEANER DIVERSEY

Special formula for heavy-duty cleaning. Use on washable hard surfaces, chrome appliances and fixtures. No rinsing or streaking. No phosphates. Trilingual packaging. Multi-surface: use on walls, floors, woodwork, cabinets, counters, ceramic tile, stainless steel, chrome, tiles and more. Concentrated for use at various dilution rates depending on soil load.

15200085 91249 32 oz., Trigger Sprayer 12/cs.

15200083 91218 1 gal., Concentrate 4/cs.



F. WINDEX® DIVERSEY

Multi-Surface Antibacterial Cleaner

Versatile cleaner effectively kills 99.9% of bacteria, removes grease and cleans surfaces, including glass, to a streak-free shine. Sanitizes hard, nonporous surfaces in 10 seconds. Disinfects hard, nonporous surfaces in five minutes. Wherever food contact is likely, rinse surface with tap water after use. See label for complete list of organisms and directions on how to sanitize and disinfect.

15200380 CB701380 32 oz., Trigger Sprayer 8/cs.

Multi-Surface Vinegar Cleaner

Cleans almost anything to a streak-free shine. Versatile for use on windows, mirrors, countertops, appliances, kitchen and bathroom surfaces, chrome and even car interiors. Non-aerosol, ammonia-free formula has no harsh vinegar smell and leaves a fresh, clean scent.

15200384 CB701397 32 oz. 8/cs.



G. SPEEDBALL® HEAVY-DUTY SPRAY CLEANER JOHNSON DIVERSEY

Conquers tough soils. Removes grease, oil encrusted soil, tire marks, ink, smoke, carbon film, graffiti, heel marks and more. Ready-to-use convenience.

57080088 4043320 1 qt., Original Scent 12/cs.

57083120 4043110 1 gal., Original Scent 4/cs.

All Purpose Cleaners



A. GLASS & MULTI-SURFACE CLEANER KAY CHEMICAL COMPANY

Super concentrated. Professional-strength glass and multi-surface cleaner. Quickly removes grease, dirt and grime from surfaces. Leaves glass clean and bright without streaking or filming.

42551270 1270 2 gal. Bag 2/cs.



B. COMET® CLEANER W/BLEACH PROCTER & GAMBLE

Cleaner w/Bleach

Supercharges your cleaning with the power of bleach. Cuts through tough grease and bleaches many troublesome food stains. Helps remove soap scum, hard water stains, and body soils in sinks, toilets and urinals. Attacks and bleaches mold and mildew stains with little to no scrubbing.

16907017 07017 32 oz., RTU 8/cs.

16902291 02291 1 gal., RTU 3/cs.

16905028 15028 1 gal., Closed Loop Concentrate 3/cs.

Powder Disinfectant Cleanser

Bleaches tough stains and disinfects as it cleans. Abrasive powder cleanser with chlorine bleach for scouring tough stains on toilet bowls, wall tiles, tubs, sinks, chrome, stainless steel, stove tops and pots and pans. Its gentle abrasives can be used on fiberglass tubs and showers, imitation marble and similar hard plastic surfaces. Effective against staphylococcus, salmonella and pseudomonas.

16908447 08447 21 oz. 24/cs.

16902987 32987 21 oz., Deodorizing 24/cs.



C. MR. CLEAN® ALL PURPOSE CLEANER PROCTER & GAMBLE

Versatile cleaner for any hard, washable surface. Leaves no dulling streaks.

16900251 80573 28 oz., Lemon Scent 9/cs.

16905306 31501 28 oz., Lemon Scent 12/cs.



D. ORVUS® WA PASTE CLEANER PROCTER & GAMBLE

Versatile surfactant cleaner. A near-neutral pH, synthetic surfactant and wetting agent with excellent detergency, emulsifying and dispersing properties. Effective in a wide range of cleaning tasks, such as cleaning rugs and upholstery and hand washing delicate fabrics.

16900285 02531 7½ lb. 4/cs.

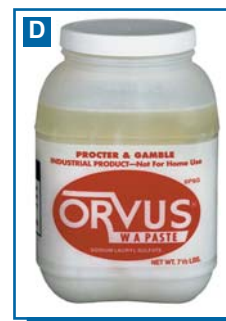

E. SPIC AND SPAN® PROCTER & GAMBLE

Disinfecting All Purpose Spray & Glass Cleaner

Powerful 3-in-1 formula helps improve cleaning productivity and simplifies cleaning while saves time in one easy step. Spic and Span replaces a glass cleaner, an all purpose cleaner, and a disinfecting cleaner. Cleans stainless steel. Hospital-grade disinfectant, bactericide, fungicide, virucide and deodorizer. EPA Registration No. 6836-245-3573. Kills Influenza A2 Hong Kong, Respiratory Syncytial Virus (RSV), Vaccinia, Herpes Simplex Type 1, Herpes Simplex Type 2, HIV-1.

16901240 31240 32 oz., RTU 8/cs.

16902535 32535 1 gal., 10X 2/cs.

16909680 32538 1 gal., 15X 2/cs.

16902326 62326 1 gal., Closed Loop 3/cs.

16908196 60319 1 gal., RTU 3/cs.

Powder All Purpose Cleaner

A versatile, heavy-duty all purpose cleaner whose power is released in water. Works great on tracked-in dirt. Non-phosphate. Use diluted (1 cup per 4 gal.) for non-waxed floors, walls, tubs and tiles. Use concentrated (2 cups per 4 gal.) and add ammonia for stripping wax and other tough jobs.

16900139 31973 27 oz. 12/cs.



CHEMICALS

All Purpose Cleaners



A. LYSOL® ALL PURPOSE CLEANERS RECKITT BENCKISER

Delivers four powerful functions in one formula. Cleaner kills 99.9% of germs on hard, nonporous surfaces. Removes soap scum, cuts grease and deodorizes. Disinfects when in dilution.

58348631 78631 40 oz., Lavender Breeze 9/cs.

All Purpose Cleaner 4 in 1

Versatile all purpose cleaner that cleans, disinfects and deodorizes. Cuts through tough grease and grime. Convenient, ready-to-use trigger spray. Kills 99.9% of bacteria in 30 seconds on hard, non-porous surfaces.

58345352 75352 32 oz., Lemon Breeze® 12/cs.

B. LYSOL® BRAND II RECKITT BENCKISER

All Purpose Cleaner

Versatile all purpose cleaner with 4-in-1 action. Kills 99.9% germs (when used as directed), cuts grease, removes soap scum and deodorizes. Convenient, ready-to-use trigger spray.

58348031 80313 32 oz., Pacific Fresh® 12/cs.

All Purpose Cleaner w/Bleach

Cleans and disinfects kitchen and bathroom surfaces. Kills germs such as: Staphylococcus aureus, Salmonella choleraesuis, mold and mildew, athlete's foot fungus, and Herpes Simplex Virus Types 1 and 2. Removes soap scum, tough food stains, and greasy dirt. Also removes mildew stains, leaving surfaces sparkling clean.

58348914 78914 32 oz. 12/cs.

C. PROFESSIONAL LYSOL® RECKITT BENCKISER

All Purpose Cleaner Plus Bleach

All purpose cleaner contains a combination of detergents and bleach to cut through tough soils, food grease and soap scum. Specially formulated for both restroom and food area surfaces. Whitens and removes stubborn mold and mildew as well as food stains. Authorized under 1998 USDA standards for use in food preparation areas (Category A-1).

58344532 94532 32 oz., Trigger Sprayer 12/cs.

Antibacterial All Purpose Cleaner

Controls mold and mildew, counteracts odors. Kills Salmonella Choleraesuis, E. coli, Staph and other bacteria. Cleaner and degreaser for food and non-food areas. For light-duty cleaning and sanitizing, makes up to 128 gal. For heavy-duty cleaning and disinfecting, makes up to 64 gal. EPA Registration No. 675-36.

58344392 74392 1 gal. 4/cs.

Antibacterial Kitchen Cleaner

Cuts through tough kitchen grease and grime. Kills harmful bacteria including Salmonella, E. coli, Listeria monocytogenes, Staph and HIV-1 (AIDS virus). No harsh chemicals, contains no abrasives or bleach. Ready-to-use. Citrus scent. EPA Registration No: 777-66-675.

58347441 74411 32 oz., Trigger Sprayer 12/cs.

D. SIMPLE GREEN® SIMPLE GREEN

All Purpose Cleaner

The original non-toxic, biodegradable, concentrated formula with a lemon scent. The concentrated formula can be diluted with water to remove grease, soap scum, stains and more from any washable, indoor or outdoor surface.

73434002 14002 24 oz., Trigger Sprayer 12/cs.

All Purpose Cleaner/Degreaser

Versatile all purpose cleaner is non-toxic and biodegradable, without harmful bleach or ammonia. Because it is a concentrate, you can use Simple Green® full strength or add water to clean just about anything.

73433012 13012 24 oz., Trigger Sprayer 12/cs.

73433013 13013 32 oz., Trigger Sprayer, Consumer Brand 12/cs.

73433014 13014 67 oz., Trigger Sprayer 6/cs.

73433005 13005 1 gal. 6/cs.

73433016 13006 5 gal. 1/ea.

73433008 13008 55 gal. 1/ea.

Clean Building™ All Purpose Cleaner Concentrate

For cleaning all water-safe hard surfaces. Concentrate offers economical dilution, and with no fragrance or volatile organic ingredients, it doesn't adversely impact indoor air quality. Green color makes it easily identified when diluted into secondary containers. Non-toxic, biodegradable, non-caustic, and non-flammable. Makes 65 gal. of ready-to-use cleaner.

73431001 11001 1 gal. 2/cs.



All Purpose Cleaners/Degreasers



A. FOAMING CITRUS CLEANER ZEP

Rich foaming, multi-purpose citrus aerosol safely cleans a wide variety of hard surfaces. Applies as thick foam to ensure proper coverage. Clings to vertical surfaces for enhanced performance and prolonged contact time. Leaves a fresh citrus scent.

75070099 R06801 24 oz. 12/cs.



B. HEAVY-DUTY ALKALINE CLEANER ZEP

All purpose cleaner and degreaser uses a blend of detergents and a water soluble solvent to remove tough soils. Compatible with a broad range of dilutions to accommodate any cleaning application. May be used in pressure washer applications or hand steaming.

75070125 R08524 1 gal. 4/cs.

75070126 R08535 5 gal. 1/ea.

High Alkaline Cleaner, Concentrated

Concentrated, multi-purpose, low-foam, powerfully alkaline, cleaner and degreaser for use in extra heavy-duty industrial cleaning applications. May be applied with mop, brush, or pressure washer. Caustic formulation acts fast on most industrial cleaning applications.

75070128 R08635 5 gal. 1/ea.



C. MULTI-SURFACE CLEANER ZEP

Heavy-duty aerosol non-streaking cleaner for glass and other hard surfaces. Premium product for cleaning any surface not normally harmed by water. Grease, surface smears, fingerprints, and other soils are easily removed by simply spraying and wiping away.

75070097 R06601 20 oz. 12/cs.



D. Z-VERDANT RTU CLEANER ZEP

Environmentally preferred, easy-to-use cleaner for use on multiple surfaces and tough soils. May be used on any surface not harmed by water. Easily breaks down common soils making it an excellent everyday cleaner. Contains no harmful solvents or harsh chemicals.

75070100 R06901 1 qt. 12/cs.

75070101 R06935 5 gal. 1/ea.



DEGREASERS

E. PREMIUM PLUS ULTRA FOAMY MEATROOM DEGREASER PRIME SOURCE®

Ultra-foamy, non-butyl degreaser is perfect for use in supermarkets and the foodservice and processing industry. Non-flammable, biodegradable, rinses away free for easy cleaning.

75004580 75004580 1 gal. 4/cs.

75004581 75004581 5 gal. 1/ea.



F. PRIME SOURCE® BREAKDOWN HIGH FOAM DEGREASER PRIME SOURCE®

High foaming degreaser effective in cleaning animal fat, blood stains and greasy soils from a variety of food tools and equipment. Excellent for foodservice and food processing customers.

75004134 75004134 1 gal. 4/cs.

75004135 75004135 5 gal. 1/ea.

75004133 75004133 55 gal. 1/ea.



G. PRIME SOURCE® CITRA KLEEN CLEANER/DEGREASER PRIME SOURCE®

Concentrated, water-based, non-butyl degreaser that rapidly dissolves grease, dirt and soils. Citra Kleen's mild citrus scent enables this product to be used in enclosed or confined areas.

75004140 75004140 1 gal. 4/cs.

76008508 76008508 3.78 L 4/cs.

76008509 76008509 18.9 L 1/ea.



Degreasers



A. PRIME SOURCE® GREEN MULTI-PURPOSE CLEANER DEGREASER **PRIME SOURCE®**
 Water-based, environmentally friendly green cleaner.
 76008502 76008502 3.78 L 4/cs.

B. PRIME SOURCE® ORANGE SOLVENT NATURAL CITRUS DEGREASER **PRIME SOURCE®**
 Powerful, d-limonene-based degreaser that effectively removes grease, oils, food soils, adhesives, inks, rubber marks, organic and inorganic soils.
 75004136 75004136 32 oz. 12/cs.
 750041371 75004137 1 gal. 1/ea.
 75004137 75004137 1 gal. 4/cs.

C. PRIME SOURCE® POWER SPRAY RTU DEGREASER/CLEANER **PRIME SOURCE®**
 Ready-to-use spray and wipe degreaser that effectively removes black heel marks, crayon, ink, adhesives and other stubborn soils.
 75004144 75004144 32 oz., RTU 12/cs.

D. PRIME SOURCE® TORNADO RTU NON-BUTYL CLEANER/DEGREASER **PRIME SOURCE®**
 Ready-to-use, non-butyl, d-limonene cleaner/degreaser that penetrates and removes heavy organic and inorganic soils from virtually any washable surface.
 75004142 75004142 32 oz., RTU 12/cs.

E. PRIME SOURCE® TUF DUTY HEAVY-DUTY CLEANER/DEGREASER **PRIME SOURCE®**
 Highly concentrated for the removal of industrial soils, oils and greases, carbon deposits and ink.
 75004130 75004130 1 gal. 4/cs.
 76008539 76008539 3.78 L 4/cs.
 76008540 76008540 18.9 L 1/ea.
 75004131 75004131 5 gal. 1/ea.
 75004132 75004132 55 gal. 1/ea.

F. DEVOUR MEATROOM FOAMING DEGREASER **CARROLL**
 Alkaline built, non-butyl, foaming cleaner/degreaser. Excellent for supermarket, food service and food processing applications. Non-flammable, biodegradable, free-rinsing. No fragrance added. USDA A1.
 30010454 13628 1 gal. 4/cs.

G. DOOR KNOCKER® CLEANER/DEGREASER **CARROLL**
 Water-based solvent, non-butyl degreaser. For industrial, institutional and commercial settings. Concentrated, moderate foam, free-rinsing. Citrus fragrance. USDA A4, A8.
 30010164 16628 1 gal. 4/cs.
 30010165 16619 5 gal. 1/ea.

H. ORANGE ALL CLEANER/DEGREASER **CARROLL**
 D-limonene formula with excellent emulsifying and dissolving ability. No petroleum solvents, no flash back odor, no hydrocarbons, no ammonia or bleach. Quickly penetrates and emulsifies a wide range of tough soils. Deodorizing citrus fragrance.
 30015828 15828 1 gal. 4/cs.

I. SOLVS IT! CLEANER/DEGREASER **CARROLL**
 Water-based, multi-use foaming spray and wipe cleaner and degreaser for use on virtually all washable surfaces and fabrics in industrial, institutional and commercial applications.
 30010036 80633 19½ oz. 12/cs.

Degreasers



A. SPRAY SOLVS IT! MULTIPURPOSE CLEANER CARROLL

Water-based solvent rapidly dissolves grease, dirt and other soils. Product can be used on most surfaces, except glass. Clear blue; fresh peppermint fragrance; USDA A8, C1.

30010138	12223	1 qt.	12/cs.
30010159	11528	1 gal.	4/cs.
30010160	11519	5 gal.	1/ea.



B. FORMULA 409® CLOROX

Cleaner/Degreaser/Disinfectant

Quickly removes grease, grime, food stains and other oil-based dirt. Powerful ready-to-use formula. EPA Registered disinfectant and sanitizer for non-food contact surfaces.

38385306	35306	32 oz., Trigger Sprayer	12/cs.
38385300	35300	1 gal., Refill	4/cs.

Heavy-Duty Degreaser

Heavy-duty degreasing for tough kitchen stains. Degreases with no filming or streaking. Cleans range hoods, stainless steel, concrete and glazed tile floors. Good for everyday cleaning or tough messes. Removes tough grease and dirt.

38385296	35296	32 oz., Trigger Sprayer	9/cs.
38380018	00014	1 gal.	4/cs.



C. AJAX EXPERT® COLGATE-PALMOLIVE

Foaming Cleaner/Degreaser

Neutral pH formula, foaming degreaser. Fragrance-free for cleaning food contact surfaces. Effective on all hard surfaces for meat rooms, food processing plants and commercial kitchens.

11904950	04950	1 gal.	4/cs.
----------	-------	--------	-------

High Performance Degreaser

Unique chemical action loosens and dissolves grease and soils. Patented formulation using microemulsion technology. Effective on heavy grease and soils on floors, walls, grills, ceramic tile, vent hoods and more. Contains biodegradable cleaning agents.

11904940	04940	1 gal.	4/cs.
----------	-------	--------	-------

Premium Degreaser

All purpose, premium formula cleaner provides more cleaning power. Eliminates greasy soils from kitchen equipment, walls, various floor surfaces, serving counters, tabletops and chairs. Recommended for quick service restaurants, institutional kitchens, schools and supermarkets. 1 gal. of concentrate makes up to 256 gal. of ready-to-use solution. Bilingual labeling.

11900009	06011	1 gal., Concentrate	4/cs.
----------	-------	---------------------	-------



D. EASY PAKS® HEAVY-DUTY CLEANER/DEGREASER DIVERSEY

Specially designed for tough floor degreasing and general purpose spray and wipe cleaning. For floors and other hard surfaces as well as stainless steel, linoleum, vinyl, asphalt, ceramic tile, quarry tile, terrazzo, marble, concrete, painted surfaces and vinyl.

15200184	90682	(36) 1 1/2 oz. Packets	72/cs.
----------	-------	------------------------	--------



E. J-WORKS™ STRATA™ NON-BUTYL CLEANER/DEGREASER DIVERSEY

A heavy-duty, premium solvent degreaser for industrial cleaning applications. Suitable for mopping, autoscrubbing, steam cleaning, pressure cleaning, foam cleaning vertical surfaces and immersion cleaning applications. Formulated to remove lubricating oils and greases, metal working fluids, shop dirt, inks, food-based soils and rubber. Purple in color with a solvent scent.

15202232	5272232	1 gal.	4/cs.
----------	---------	--------	-------



Degreasers



A. SUMA® KITCHEN DEGREASER D2.4 DIVERSEY

A highly concentrated blend of surfactants that delivers superior degreasing of hard surfaces. It can be used on most surfaces in a food service environment, and it is non-corrosive—even in its concentrated form. It produces thick long-lasting suds which help to cut through grease and penetrate and lift soils off of surfaces, but rinses easily without leaving residues. Dark green in color with no fragrance added.

15200547 3738318 32 oz. Empty Spray Bottle 12/cs.
15200537 3062493 5 L RTD® 1/ea.



B. WHISTLE® DEGREASER/DISINFECTANT TB DIVERSEY

For use as a cleaner and disinfectant in hospitals, nursing homes, schools and hotels. Tuberculocidal, fungicidal, virucidal, kills Hepatitis B and HIV. Formulated to disinfect hard, nonporous surfaces such as walls, sink tops and tables. Deodorizes areas which generally are hard to keep fresh smelling. Colorless with a lemon scent.

15200084 91330 32 oz. 6/cs.



C. DCT HEAVY-DUTY DEGREASER DIVERSIFIED CHEMICAL

Full-strength cleaning for tough, greasy soils. Non-corrosive to hands. Solvent-based degreaser for the full-strength cleaning of extra-tough, greasy buildups on surfaces like range hoods, ovens, walls behind equipment, floors, drive-thrus, and fuel islands. Can be used on food contact surfaces. Contains no phosphate, non-caustic, and nonflammable.

C5740001 00001 1 gal. 4/cs.



D. KAY CHLORINATED CLEANER KAY CHEMICAL COMPANY

Superior degreasing ability. Designed for heavy protein-soil load of the food retail environment. Brightens and whitens grout on floor and walls. Well-suited to a wide range of applications. Non-corrosive to skin or eyes.

42550020 1347 2½ gal. 1/ea.



E. DAWN® PROCTER & GAMBLE

Power Dissolver

Specially formulated to dissolve burnt-on, baked-on, carbonized grease and foods from the bottoms and outsides of pots, pans and baking sheets, eliminating the need to scour. Uses a patented solvent-based formula to quickly penetrate and dissolve grease, making it simple to wipe grease away. Also an effective, safe-to-use oven cleaner.

16901983 01983 32 oz. 6/cs.

Heavy-Duty Degreaser

Full-strength cleaning for tough, greasy soils. Non-corrosive to hands. Solvent-based degreaser for the full strength cleaning of extra tough, greasy build-up on surfaces like range hoods, ovens, walls behind equipment, floors, drive-thrus and fuel islands.

16904853 04853 64 oz. 5/cs.

16904852 84957766 1 gal. 3/cs.



F. EASY-OFF® HEAVY-DUTY CLEANER/DEGREASER RECKITT BENCKISER

Specially formulated to cut through kitchen grease, fat, oil and petroleum. Non-flammable formula easily removes tough, oily soil from a wide variety of surfaces. Controlled suds for easy rinsing. Can be used in pressure washers and automatic scrubbers. Concentrated formula is economical to use. USDA A-1.

58344383 74383 1 gal. 4/cs.

Degreasers/Sanitizers



A. CRYSTAL SIMPLE GREEN® INDUSTRIAL STRENGTH CLEANER/DEGREASER SIMPLE GREEN

Safe, effective and powerful all purpose cleaner/degreaser for critical cleaning applications that demand a fragrance-free solution. Non-toxic, non-abrasive and no caustic fumes. Exempt from OSHA and EPA special handling and personal protection requirements. Approved for use in federally inspected meat and poultry plants, and meets Montreal Protocol Guidelines and FDA requirements for cleaning cosmetics, medical and pharmaceutical environments. Excellent for use in parts washers, pressure washers, floor scrubbers and other mechanized applicators.

73439010	19010	20 oz., Foaming Aerosol	12/cs.
73439024	19024	24 oz., Trigger Sprayer	12/cs.
73439128	19128	1 gal.	6/cs.
73439055	19055	55 gal.	1/ea.



B. FOAMING HEAVY-DUTY DEGREASER ZEP

Industrial strength aerosol cleaner and degreaser strong enough for the toughest cleaning jobs. For use on vinyl, ceramic, Formica, porcelain, stainless steel, and other hard surfaces.

75070098	R06701	20 oz.	12/cs.
-----------------	--------	--------	--------



C. HEAVY-DUTY BUTYL DEGREASER ZEP

Industrial strength butyl formulation cuts through greases, oils, and other tough soils. Low foaming, free-rinsing, biodegradable formula may be applied with a mop or pressure washer. Broad dilution range for a variety of applications.

75070131	R08824	1 gal.	4/cs.
-----------------	--------	--------	-------



D. HEAVY-DUTY CITRUS DEGREASER ZEP

Organic, non-petroleum cleaner and degreaser with d-limonene and soy for use on equipment and machinery. Utilizes renewable resources to cut through tough grease.

75070111	R07701	1 qt.	12/cs.
75070112	R07724	1 gal.	4/cs.

E. VOC COMPLIANT SOLVENT DEGREASER ZEP

Environmentally preferred, solvent-based degreaser with d-limonene for use where a water-free formula is preferred. Meets all CA-CARB and OTC requirements.

75070113	R07824	1 gal.	4/cs.
75070114	R07835	5 gal.	1/ea.

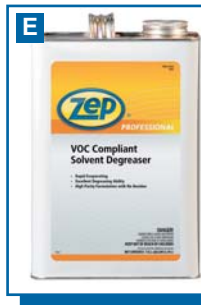

FREEZER CLEANERS

F. PRIME SOURCE® FREEZE CLEAN FREEZER CLEANER PRIME SOURCE®

Ready-to-use cleaner with anti-freeze properties. Use to remove soils in sub-freezing conditions.

75004007	75004007	1 gal.	4/cs.
-----------------	----------	--------	-------

G. JOHNSON® FREEZER FLOOR CLEANER DIVERSEY

Low temperature formula keeps freezer surfaces and floors clean without shutdown. Works down to -5°F.

15208130	48030	1 gal.	4/cs.
-----------------	-------	--------	-------



H. SUMA® FREEZE D2.9 FREEZER CLEANER DIVERSEY

Suma® Freeze should be used undiluted. Formula is a combination of detergents and anti-freeze agents.

15200237	57222270	1 gal.	20001/cs.
-----------------	----------	--------	-----------

Sanitizers/Vandal/Graffiti/Gum



SANITIZERS

A. CLOROX® ANYWHERE® HARD SURFACE™ CLOROX

Daily Sanitizing Spray

A convenient way to sanitize. It's gentle enough to use on hard, nonporous surfaces around kids and food, yet powerful enough to kill 99.9% of common household bacteria, E. coli, Salmonella, Staphylococcus (Staph) and Streptococcus (Strep.). Plus, since it has no harsh fumes and leaves no harmful residue, it needs no wiping or rinsing.

38381683 01683 22 oz. 9/cs.

Sanitizing Spray

Revolutionary food-safe sanitizer. Kills 99.9% of bacteria, but its pH-balanced formula can be used on food-contact surfaces. Usage: commercial kitchens, day care facilities, schools. Gentle as water. Labor-saving formula, clean and sanitize in one step with no rinsing required.

38381698 01698 32 oz. 12/cs.

B. SANI-SURE® DIVERSEY

Multi Surface Sanitizer

For use on both food and non-food contact surfaces. Use on tabletops, countertops, floors, walls, sinks, splash backs and trays. For use on food processing/preparation equipment. Trichloromelamine (TCM) formula provides 125 ppm available chlorine to be used during each eight hour shift.

15200101 90670 1/8 oz. Packets 100/cs.

Soft-Serve Sanitizer

Highly-concentrated formula is ideal for shake, slush, soft-serve or yogurt machines. No-foaming formula. Premeasured pouch designed to help control costs, product waste and inventory. Excellent for the removal of fat particles; helps dissolve milkstone and protein.

15200153 90234 1 oz. Packets 100/cs.

C. KAYQUAT® II SANITIZER KAY CHEMICAL COMPANY

EPA registered formula is a hard surface sanitizer effective against Escherichia coli, Escherichia coli O157:H7, and Listeria monocytogenes. Also effective against Yersinia enterocolica and Staphylococcus aureus. Automatically proportioned, closed system. Color coded, icon labeled packaging encourages correct use. Effective at 150-400 ppm.

42551306 1306 2 gal. Bag 2/cs.

D. CLEAN QUAT LIQUID QUATERNARY SANITIZER PROCTER & GAMBLE

For third-sink sanitizing of dishes, glasses, silverware, cooking utensils, and sanitizing hard (non-porous) surfaces, such as chopping blocks and countertops. 200 ppm active quaternary when diluted at 1 oz. per 5 1/2 gal. water.

16900127 07534 1 gal. 3/cs.

E. PROFESSIONAL LYSOL® NO RINSE SANITIZER RECKITT BENCKISER

Meets federal food code requirements as a no rinse sanitizer. Perfect for three-bin sink and clean-in-place applications. Can also be used to disinfect and deodorize. Economical, concentrated formula makes up to 512 gal. Controls algae in swimming pools and industrial non-potable water supplies. EPA Registration No: 675-30.

58340010 74389 1 gal. 4/cs.

VANDAL/GRAFFITI/GUM

F. PRIME SOURCE® CHIP OFF GUM & WAX REMOVER PRIME SOURCE®

Spray on and chip off. Use on carpets, upholstery, wood, vinyl or cloth.

76000771 76000771 184 g 12/cs.

75004571 75004571 7 oz. 12/cs.

Vandal/Graffiti/Gum/Glass Cleaners



A. PRIME SOURCE® GRAFFITI VANDAL MARK REMOVER PRIME SOURCE®

Powerful cleaning action with clean, fresh fragrance. Use on wood, metal and painted products.

75004570 75004570 16 oz. 12/cs.
76000770 76000770 511 g 12/cs.



B. GUM REMOVER DIVERSEY

A spotter designed for the removal of gummy materials from carpets and hard surfaces. Non-flammable. No CFCs, will not harm the ozone layer. Works on many gummy materials. Use on chewing gum, tar, wax and more.

15202603 5002603 32 oz. 6/cs.



C. PAINT, OIL & GREASE REMOVER DIVERSEY

All purpose solvent-based spotter. Removes paint, oil, grease, asphalt, tar and shoe polish.

15203888 13888 32 oz. Gel 6/cs.



D. SPITFIRE™ GRAFFITI REMOVER DIVERSEY

A RTU spray and wipe graffiti remover. Effectively removes inks, markers, lipstick, graphite and most other common graffiti from hard, indoor surfaces (including glass). Contains no phosphates, butyl ethers, caustics or alcohols and requires no rinsing.

15204915 4915 32 oz. 12/cs.



E. PRE-MOISTENED GRAFFITI REMOVER TOWELS ZEP

Heavy-duty, dual surfaced towels with powerful solvent action for quick removal of paint and ink from boats, vehicles, phone booths, glass, tile, and most uncoated metal surfaces.

75070136 R09101 72 ct. 6/cs.



F. VANDAL MARK REMOVER ZEP

Non-chlorinated formulation removes ink, crayon, pencil, adhesives, and grease from most painted surfaces, wood paneling, furniture, vinyl seats, wall coverings, Formica, fiberglass, and most plastics. For indoor and outdoor use.

75070092 R06201 24 oz. 12/cs.



GLASS CLEANERS

G. PRIME SOURCE® GLASS CLEANER PRIME SOURCE®

A concentrated, economical product that is effective on many difficult soils. Fast drying, streak-free formula, 1:8 dilution. Ideal for use on many hard surfaces. VOC and A.P.E. free.

76008538 76008538 3.78 L 4/cs.



AMMONIATED GLASS CLEANERS

H. WINDA SHINE GLASS CLEANER CARROLL

Fortified with an undetectable splash of ammonia for an extra burst of grease cutting ability. Non-streaking foaming cleaner with fast drying and anti-fogging ingredients. Cleans and polishes glass and other hard surfaces. Pleasant fragrance.

30010034 80333 18½ oz. 12/cs.



I. AJAX EXPERT® GLASS AND MULTI-SURFACE CLEANER COLGATE-PALMOLIVE

Powerful ready-to-use formula requires no mixing and is convenient to use. Dual solvent system cuts through film and grease fast. Contains ammonia for extra cleaning power. Flash dries quickly without streaking or filming. Use on glass, countertops, mirrors and other hard washable surfaces. Contains biodegradable surfactants. Bilingual labeling. DfE approved formula.

11901340 74199 32 oz., Trigger Attached 12/cs.
11901320 04195 1 gal., Concentrate 4/cs.
11904174 04174 1 gal., RTU 4/cs.



Ammoniated & Non-Ammoniated Glass Cleaners



A. GLANCE® GLASS & MULTI-SURFACE CLEANERS DIVERSEY

Non-streaking, non-smearing, quick drying formula. Cleans and shines glass, mirrors, sinks, countertops, stainless steel, and many other washable surfaces.

15207056	04553	19 oz., Aerosol	12/cs.
15204705	04705	32 oz., Spray Bottle	12/cs.

B. WINDEX® GLASS CLEANERS W/AMMONIA-D® DIVERSEY

Original

Cleans with Ammonia-D® for a streak-free shine. Loosens soil upon contact. Will not streak or leave a film. Also cleans chrome, stainless steel, Plexiglas®, mirrors, ceramic tile, enamel, plastic and other hard surfaces. Contains no phosphates.

15204123	CB001237	12 oz., Sprayer	12/cs.
-----------------	----------	-----------------	--------

Super Concentrate

Cleans with Ammonia-D® for a streak-free shine. Loosens soil upon contact. Won't streak or leave a film. Also cleans chrome, stainless steel, Plexiglas®, mirrors, ceramic tile, enamel, plastic and other hard surfaces. Contains no phosphates. 6 quarts per case; each quart yielding 9 quarts of ready-to-use glass cleaner. Improved formula, 1:8 concentration; 13% more product per case (six additional ready-to-use quarts).

15200381	4601541	32 oz.	6/cs.
-----------------	---------	--------	-------

Powerized Foaming

Cleans with Ammonia-D® for a streak-free shine. Loosens soil upon contact. Will not streak or leave a film. Also cleans chrome, stainless steel, Plexiglas®, mirrors, ceramic tile, enamel, plastic and other hard surfaces. Contains no phosphates.

15200080	90129	567 g, Aerosol	12/cs.
-----------------	-------	----------------	--------

Powerized RTU

Cleans with Ammonia-D® for a streak-free shine. Loosens soil upon contact. Won't streak or leave a film. Also cleans chrome, stainless steel, Plexiglas®, mirrors, ceramic tile, enamel, plastic and other hard surfaces. Contains no phosphates. NSF C1 Registered.

15200082	90139	32 oz., Trigger Sprayer	12/cs.
15200161	90135	32 oz., Trigger Sprayer, Capped	12/cs.
15200081	90940	1 gal., Refill	4/cs.
15200007	90122	5 gal., Bag-in-Box	1/ea.

Original - Wipes

Windex streak-free shine available in an easy-dispensing flat pack. Effective on windows, glass, mirrors and other hard surfaces. Anti-static wipes.

15200570	CB702325	28 ct.	12/cs.
-----------------	----------	--------	--------



C. GLASS CLEANER ZEP

Ready-to-use non-aerosol glass and surface cleaner used to clean any surface not damaged by water. Ammonia formulation removes fingerprints and smudges quickly and effectively.

75070071	R04601	1 qt., RTU	12/cs.
75070072	R04624	1 gal., RTU	4/cs.

NON-AMMONIATED GLASS CLEANERS

D. PRIME SOURCE® ECONO GLASS CLEANER PRIME SOURCE®

Economical, film-free cleaning. Controls dust accumulation. Safe, non-ammonia formula.

75004054	75004054	1 gal.	4/cs.
-----------------	----------	--------	-------

E. PRIME SOURCE® FILM-FREE GLASS CLEANERS PRIME SOURCE®

Heavy-duty, streak-free cleaning. Helps control dust and fingerprints. Non-ammonia; may be used on Plexiglas® surfaces.

Aerosol

75004049	75004049	19 oz.	12/cs.
760007671	76000767	539 g, Aerosol	1/ea.
76000767	76000767	539 g, Aerosol	12/cs.

Liquid

75004050	75004050	1 qt.	12/cs.
76008546	76008546	946 mL, RTU	12/cs.
75004051	75004051	1 gal.	4/cs.
75004053	75004053	55 gal.	1/ea.



Non-Ammoniated Glass Cleaners



A. ENVIROPATROL® GLASS & SURFACE CLEANER CARROLL

Use as a high performance glass and utility cleaner. Can be used as a spray and wipe glass cleaner or with a sponge and squeegee. Leaves no residues. Helps prevent resoiling. Use on Plexiglas®, windows, windshields, walls, countertops, cabinets, partitions, light fixtures, stainless steel, chrome, plastic, vinyl and other hard surfaces not harmed by water. Dilutes at 1 oz./gal. (1:128) for most applications. Cold water effective.

30018228 18228 1 gal. 4/cs.



B. GLASS & SURFACE CLEANER CARROLL

An extra-strength, concentrated super-base intended to be diluted before use. Economically dilutable to 8 oz. per gallon of water for everyday cleaning of glass, mirrors and other hard surfaces.

30010133 18328 1 gal. 4/cs.



C. WINDA SHINE GLASS & UTILITY CLEANER CARROLL

Ready-to-use institutional glass cleaner with non-streaking and fast drying qualities. Non-ammoniated formula. Special anti-fogging ingredients help maintain surfaces in the presence of steam. Resist resoiling and reduce dust-attracting static. Pleasant floral fragrance.

30010129 14123 1 qt., Light Blue 12/cs.
30010130 14128 1 gal., Light Blue 4/cs.



D. GLEME GLASS CLEANER CLAIRE

A multi-purpose, heavy-duty formulation that cleans, brightens and polishes glass and many other hard surfaces. Fast drying and leaves no film. Safe for use on acrylics, polycarbonates, Formica, chrome, porcelain, and tile. Special denatured alcohol leaves a pleasant, fresh aroma.

25950050 CL050 20 oz. 12/cs.



E. FORMULA 409® GLASS & SURFACE CLEANER CLOROX

Our cleaner powerfully cuts through the grime found on many surfaces such as glass, mirrors and stainless steel. Formulated for streak-free, crystal clear surface cleaning.

38381270 35293 32 oz., Trigger Sprayer 9/cs.
38381269 03107 1 gal., Refill 4/cs.



F. GREEN WORKS® NATURALLY DERIVED GLASS & SURFACE CLEANER CLOROX

Our product is made using fine natural ingredients such as essential oils and coconut-based cleaners. Cuts through filmy residue and is safe on multiple surfaces throughout the kitchen and bathroom, including glass, mirrors, appliances, stainless steel and sealed granite. Removes tough dirt and residue for a streak-free shine. 95% naturally derived and contains no ammonia. Safe to use on a wide variety of surfaces.

38380459 00459 32 oz., Trigger Sprayer 12/cs.
38380460 00460 64 oz., Refill 6/cs.



G. GLASS PLUS® GLASS CLEANER DIVERSEY

Light-duty, non-ammoniated glass cleaner cuts through dirt, grease and grime on windows, mirrors, appliances and more.

15200049 94378 32 oz., Trigger Sprayer 12/cs.



H. LITE TOUCH™ CRT & PLEXIGLAS® CLEANER DIVERSEY

Designed for cleaning where static control is a problem. Surface actually repels dust after cleaning so they remain cleaner longer. Pleasant to use, non-flammable formula contains no ammonia or solvents.

15203970 3970 32 oz., RTU 12/cs.



Glass & Electronics Cleaners/Furniture Polish



A. PROFESSIONAL EASY-OFF® AMMONIA-FREE GLASS CLEANER **RECKITT BENCKISER**
 Concentrate makes up to 10 gal. of cleaning solution. Specifically formulated to help prevent scratching by dissolving dirt particles. Cleans mirrors, glass, display cases, telephones, appliances, tile, vinyl, laminated plastics. Leaves surface streak-free and film-free with no rinsing.
 58345116 75116 1 gal. 4/cs.



B. SIMPLE GREEN® CLEAN BUILDING™ GLASS CLEANER CONCENTRATE **SIMPLE GREEN**
 Specifically for streak and smear-free cleaning of glass and other reflective surfaces. Concentrate offers economical use dilution with no added fragrance or volatile organic ingredients that can adversely impact indoor air quality. Also safe to use on plastics. Non-toxic, biodegradable, non-caustic, and non-flammable formulation. Makes 31 gal. of ready-to-use cleaner.
 73431201 11201 1 gal. 2/cs.



C. FOAMING GLASS CLEANER **ZEP**
 Water-based solvents and fast-acting surfactants in a foaming aerosol glass and mirror cleaner dissolves tobacco residue, grease, and fingerprints. Can be used on any surface not harmed by water. Dries evenly and quickly to eliminate streaking. VOC compliant formulation.
 75070073 R04701 24 oz. 12/cs.



ELECTRONICS CLEANER



D. WINDEX® ELECTRONICS CLEANER **DIVERSEY**
 A safe and easy way to clean your electronics. For use on televisions, cell phones, game stations, remote controls, computers and more. Gentle formula removes dust, fingerprints and smudges. Provides a streak-free shine and leaves no residue.
 15202288 CB702288 9 7/8 oz., Aerosol 6/cs.

FURNITURE POLISH



E. FINESHINE FURNITURE POLISH AEROSOL **PRIME SOURCE®**
 Blend on natural beeswax, carnauba wax, lemon oil and silicone leaves an even and deep gloss. Can safely be used on light or dark woods, plastic, marble and enameled surfaces.
 75004066 75004066 18 oz. 12/cs.



F. PRIME SOURCE® GLAZE LEMON FURNITURE POLISH **PRIME SOURCE®**
 A rich blend of natural beeswax and carnauba wax. Protects furniture against water marks, scratches and stains. May also be used on plastic and vinyl.
 75004065 75004065 16 oz. 12/cs.
 76000768 76000768 539 g 12/cs.



G. FURNITURE POLISH **CLAIRE**
 An emulsion polish that dusts and cleans in one application. A rich blend of silicones and lemon oil that cleans, polishes, and protects fine furniture, woodwork, vinyl, plastic, Formica, leather, and metal. Leaves a clear, bright shine.
 25950811 CL811 20 oz. 12/cs.

H. JOHNSON MULTI™ FOAM CLEANER **DIVERSEY**
 The pleasantly scented professional foam that cleans and shines simulated wood furniture, chrome, stainless steel, vinyl, plastic counter-tops and more with no build-up.
 15207178 4390 15 oz. Aerosol 12/cs.

Furniture Polish



A. PLEDGE® FURNITURE POLISH DIVERSEY

Leading name in wood care. Gentle cleansing conditioners remove fingerprints, smudges and dirt from wood furniture, cabinets, paneling, vinyl and leather. Shines, dusts, polishes and protects in one easy step. Lemon scent.

15209439 CB003995 12½ oz. 12/cs.
15200002 94430 18 oz. 6/cs.

Dust & Allergen

Anti-dust formula with Allergen Trappers® keep surfaces dust-free longer. Leaves no waxy build-up. No CFCs. Light, clean fragrance.

15204431 CB003971 12½ oz., Outdoor Fresh 12/cs.

Multi-Surface Cleaner

Safely removes dust, fingerprints, smudges and smears from almost any surface. No-wax formula leaves no residue or build-up behind. Can be used on wood, glass, metal, electronics, plastic, mirrors, stainless steel, chrome, marble, granite, appliances, countertops, porcelain and more.

15200383 CB703123 16 oz. 6/cs.

Wipes

Premoistened to clean, polish and protect furniture. Wipes leave a natural, protective shine with no wax buildup. Brings out the natural beauty every time you clean. Lemon scent.

15200166 CB121286 18 ct., 7" x 10" 12/cs.

Wood Cleaner

Versatile cleaner designed for commercial use and formulated with gentle agents and conditioners. Cleans dirt and grime leaving behind a residue-free finish. Rinsing and drying wood is not necessary.

15200189 94440 1 gal., Concentrate 4/cs.



B. SHINE-UP™ LEMON FURNITURE POLISH DIVERSEY

Cleans and polishes furniture to a beautiful shine. Resists smears and fingerprints. White in color with a lemon scent.

15202788 4502788 17⅞ oz., Aerosol 12/cs.
15205500 4995480 32 oz., Trigger Sprayer 12/cs.



C. OLD ENGLISH® FURNITURE POLISH RECKITT BENCKISER

Aerosol

Cleans, shines and conditions without wax build-up. Contains conditioning Old English® oil to beautify and preserve wood. Helps prevent drying and cracking and protects against ordinary wear such as dust and fingerprints.

58344035 74035 12½ oz., Lemon 12/cs.

Oil

Gently moisturizes and protects wood without wax or silicones. Protects against drying and cracking, giving wood a rich, natural glow as it removes dirt and stains. Perfect for use on teak, oak, walnut, cherry, and all other natural woods including today's lighter veneers.

Preserves and restores wood's natural beauty.
58341863 01863 8 oz. 12/cs.



D. OLD ENGLISH® WIPES RECKITT BENCKISER

Furniture Wipes

Quick and disposable with no residue build-up. Removes dust and smudge marks.

58345821 75821 25 ct., 7½" x 10½" 12/cs.

Wood Care Microfiber Wipes

Cleans, shines and conditions without wax to beautify and preserve wood. Helps prevent drying and cracking and protects against ordinary wear. Ideal for nicks and scratches. Fresh lemon scent.

58345825 79722 25 ct. 6/cs.



Furniture & Metal Polish



A. OLD ENGLISH® SCRATCH COVER RECKITT BENCKISER

Helps restore damaged wood surfaces. Hides unsightly scratches and nicks.

58345144	75144	8 oz., Dark Wood	6/cs.
58345462	75462	8 oz., Light Wood	6/cs.



B. LEMON FURNITURE POLISH ZEP

Removes dirt, fingerprints, grease marks, and smudges. Premium formulation contains lemon oil to condition wood and other hard surfaces. Polishes to a deep glossy shine. Contains no wax.

75070068	R04401	20 oz.	12/cs.
----------	--------	--------	--------



C. PRIME SOURCE® BRITE STAINLESS STEEL CLEANER PRIME SOURCE®

Water-based formulation cleans, shines and protects. Use on chrome, aluminum, brass and copper.

75004062	75004062	16 oz.	12/cs.
----------	----------	--------	--------



D. PRIME SOURCE® FLARE STAINLESS STEEL CLEANER PRIME SOURCE®

Oil-based formulation helps seal out corrosion. Restores original brilliance to stainless steel.

76000769	76000769	425 g	12/cs.
75004061	75004061	15 oz.	12/cs.



E. 3M™ STAINLESS STEEL CLEANER & POLISH 3M

Cleans and polishes stainless steel, chrome, aluminum and laminated plastic surfaces. Pleasant lime fragrance. Contains no petroleum distillates.

66551402	61500061322	21 oz.	12/cs.
----------	-------------	--------	--------



F. AQUA STEEL STAINLESS STEEL CLEANER CARROLL

A hard surface maintainer for stainless steel, copper, brass and other reflective or glossy non-porous surfaces. Cleans, polishes and protects without greasy feel or solvent odor.

30010044	81233	18 oz.	12/cs.
----------	-------	--------	--------

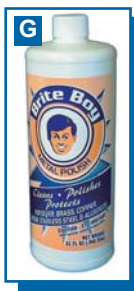

G. BRITE BOY METAL POLISH CARROLL

The premier polish for brass, metal, aluminum, copper and silver. Unique formula stands alone in performance and ease of use. Cleans, restores and protects. Ready-to-use.

30019212	49211	16 oz.	12/cs.
30019232	49232	32 oz.	12/cs.



H. STAINLESS STEEL CLEANER/POLISH CLAIRE

A blend of cleaning solvents, detergents and fine oils. Cleans, polishes and protects stainless steel without hard rubbing and polishing. Resists fingerprints, grease, and water spatter. Helps preserve the factory finish.

25950842	CL841	20 oz.	12/cs.
----------	-------	--------	--------



I. DEEP GLOSS® STAINLESS STEEL MAINTAINER DIVERSEY

Creamy, water-based spray cleans, polishes and protects stainless steel without abrasives. Resists smudges and water-marks.

15200590	4970590	16 oz. Aerosol	12/cs.
----------	---------	----------------	--------

METAL POLISH

Metal Polish



A. SUMA[®] INOX D7 CLEANER & POLISH DIVERSEY

An oil-based, ready-to-use cleaner and polish for use on stainless steel non-food contact surfaces and other metal surfaces, such as brass, aluminum and copper. Ideal for use on refrigerator doors, handles, trolleys and dishwashing machines. Leaves the surface clean and shiny. Colorless with a hydrocarbon scent.

15208259 4368259 32 oz. 6/cs.



B. TWINKLE[®] STAINLESS STEEL CLEANER & POLISH DIVERSEY

Water-based formula removes grease, dirt, fingerprints, smudges and water marks from stainless steel, brass, aluminum and chrome. Leaves no residue or greasy film. Protects against re-soiling. Contains no CFCs. White in color with a lemon scent. NSF C1 Registered.

15200090 91224 17 oz. 12/cs.



C. DCT STAINLESS POLISH PROCTER & GAMBLE

Cleans while it restores. Gentle yet effective, maximum gloss with minimal work.

16909592 84959219 32 oz. 4/cs.



D. BRASSO[®] MULTIPURPOSE METAL POLISH RECKITT BENCKISER

Wipes away tarnish on most metals, leaving a brilliant shine. Gently cleans and polishes brass, copper, chrome, stainless steel and pewter. Removes tarnish quickly and easily.

Contains no harsh acids. Leaves a smooth, polished surface and a brilliant shine. Ideal to clean brass fixtures and banisters. Ready-to-use.

58346600 76523 8 oz. 8/cs.



E. NOXON[®] METAL POLISH RECKITT BENCKISER

Thick, easy-to-use formula. Designed for brass, copper, chrome, stainless steel, bronze, pewter and aluminum.

58340120 00117 12 oz. 12/cs.

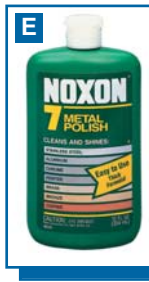

F. PROFESSIONAL EASY-OFF[®] STAINLESS STEEL CLEANER & POLISH RECKITT BENCKISER

Resists fingerprints and watermarks. Contains no abrasives and will not scratch surfaces. Removes fingerprints, smears and soils. Oil-based. Helps restore shine. Virtually odorless.

58346461 76461 17 oz. 6/cs.



G. SHEILA SHINE[®] STAINLESS STEEL CLEANER/POLISH SHEILA SHINE

Sheila Shine[®] cleans, polishes and protects in one step. The Sheila Shine[®] process requires no rubbing or polishing. Sheila Shine[®] removes dirt and grime, greasy film, water marks and even covers scratches. Immediately forms a protective coating on any surface that repels water, prevents penetration of harmful liquids and retains its gloss indefinitely. Resists fingerprints and streaking. Preserves the surface against deterioration of all kinds. Does not contain acid, silicon or any abrasive substance.

73440002 1 10 oz. Aerosol 12/cs.
 73440001 2 1 qt. 12/cs.
 73440003 3 1 gal. 4/cs.



H. STAINLESS STEEL CLEANER & POLISH ZEP

Water-based stainless steel aerosol polish. May be used on other hard surfaces. Leaves a water resistant shield that inhibits fingerprints. Fresh lemon fragrance. Leaves surface dry. VOC compliant.

75070115 R07901 24 oz. 12/cs.



Oven & Grill Cleaners



CHEMICALS



OVEN & GRILL CLEANERS

A. PRIME SOURCE® SPARK OVEN & GRILL CLEANERS PRIME SOURCE®

Economical to use. Removes tough grease, grime and carbonized soil from ovens and grills.

Aerosol

75004150	75004150	18 oz.	12/cs.
76000765	76000765	511 g	12/cs.

Liquid

75004151	75004151	1 qt.	12/cs.
76008551	76008551	946 mL	12/cs.
75004152	75004152	1 gal.	4/cs.
76008514	76008514	3.78 L	4/cs.



B. PRIME SOURCE® ULTRA GRILL COLD OVEN & GRILL CLEANER PRIME SOURCE®

Use on hot or cold surfaces. Removes tough grease, grime and carbonized soil from ovens and grills.

75004154	75004154	1 gal.	4/cs.
----------	----------	--------	-------

C. HEAVY-DUTY OVEN & GRILL CLEANER CARROLL

Highly alkaline, biodegradable cleaner and carbon remover. Penetrates help eliminate or reduce scouring and scraping. Effective on steel, stainless steel and porcelain surfaces. No fragrance added. USDA A8.

30010528	40528	1 gal.	4/cs.
----------	-------	--------	-------



D. AJAX® OVEN & GRILL CLEANER COLGATE-PALMOLIVE

High foaming degreaser-cleanser penetrates and removes baked on foods, grease and carbon deposits. Removes soil and food deposits, which can hamper the food's flavor. Cleans on hot or cold surfaces. Non-flammable. Phosphate-free.

11904926	04926	32 oz.	12/cs.
----------	-------	--------	--------

E. MR. MUSCLE® OVEN & GRILL CLEANERS DIVERSEY

Institutional formula with heavy-duty cleaning power for fast and easy cleaning of institutional, industrial and commercial surfaces. Works immediately on warm or cold ovens. Self-scouring action with unsurpassed clinging ability starts breaking down tough, baked-on grease and grime on contact, for less scrubbing. Dual usage for quick jobs or time lapse actions. Aerosol contains no CFCs.

Aerosol

15200087	91206	19 oz.	6/cs.
----------	-------	--------	-------

Liquid

15200151	91208	32 oz. Trigger Sprayer	6/cs.
----------	-------	------------------------	-------



F. PRIDE™ OVEN/GRILL CLEANER DIVERSEY

Fast-acting formula cuts through tough grease on ovens, grills and deep fryers. Works better because it's thicker and clings to vertical surfaces.

15200070	48049	32 oz.	12/cs.
----------	-------	--------	--------

G. SUMA® FOAM FREE™ LIQUID OVEN CLEANER & DEGREASER DIVERSEY

Liquid oven cleaner and general degreaser. Cleans greasy carbonized soils. Foaming properties eliminate fumes associated with harsh oven cleaners. Can be used to clean ovens, grills, hoods and deep fryers.

15203529	03529270	32 oz.	12/cs.
----------	----------	--------	--------



H. DCT HI-TEMP GRILL CLEANER DIVERSIFIED CHEMICAL

High temperature grill cleaner.

C5740003	00033	1 qt.	6/cs.
----------	-------	-------	-------

Oven, Grill & Fryer Cleaners/Block Whiteners



A. PROFESSIONAL EASY-OFF® RECKITT BENCKISER

Fume Free Max™ Non-Caustic Oven Cleaner

The advanced cold-oven technology penetrates tough oven grease and effectively cleans with no lye or harsh fumes, so no need for protective gloves. Use on ovens, broilers and barbecue grills.

58340178 00178 16 oz. 12/cs.
58344017 74017 24 oz. 6/cs.

Oven & Grill Cleaner - Aerosol

Advanced grease-cutting formula for burned-on grease and grime. Self-scouring action cleans a wide variety of surfaces, equipment and utensils. Can be used on warm and cold ovens.

58340138 00148 16 oz. 12/cs.
58340395 04250 24 oz. 6/cs.

Oven & Grill Cleaner - Liquid

Advanced ready-to-use formula quickly removes caked-on grease. Non-flammable, ready-to-use, thick formula clings to vertical surfaces. Rapid penetration saves time and money by minimizing scouring and scrubbing. Works on hot grills up to 170°F, no need to shut down grill. No offensive odor.

58340022 80689 64 oz. 6/cs.



FRYER CLEANER

B. MR. MUSCLE® FRYER BOIL-OUT DIVERSEY

Frequent cleaning with Mr. Muscle® Fryer Boil-Out enhances the characteristics of equipment and improves the quality of fried food. A clean fryer operates more efficiently and lasts longer. Carbonized grease that has accumulated on the interior surface of the fryer imparts a rancid flavor to deep-fried foods. This problem is eliminated with routine use of Mr. Muscle®, as shortening stays fresher and works longer in equipment that is cleaned on a regular basis. Portion control pouch helps simplify product handling, eliminates waste and control cost. Low-foaming formula degreases and cleans foodservice fryers, while preventing boil over. Heat and chemical action combine to penetrate, emulsify and clean away built-up grease. Eliminate the need for neutralizing. Non-corrosive. Contains no phosphates. NSF A8 Registered.

15200086 91209 2 oz. 36/cs.



BLOCK WHITENERS

C. AJAX® CUTTING BOARD DESTAINER COLGATE-PALMOLIVE

Ready-to-use cutting board destainer. Cleans cutting boards and chopping blocks. Bleach formula.

11904180 04179 1 gal. 4/cs.



D. JOHNSON® LIQUID BLOCK WHITENER DIVERSEY

Non-corrosive thick liquid formula provides lightning quick cleaning and whitening of cutting boards. RTU container.

15204404 4404 1 gal. 4/cs.

E. BLOCK WHITENER KAY CHEMICAL COMPANY

Increased cleaning power improves stain removal capabilities. Noncorrosive to eyes and skin. Fast-acting formula eliminates stains and food soil from cutting boards and food processing surfaces. Improved formula provides superior results. Thoroughly penetrates scuffs and scratches. Ensures a deep-down clean.

42551017 1017 1 gal. 4/cs.



Hand Dishwash



HAND DISHWASH - LIQUID

A. PRIME SOURCE® EMERALD ISLE PRIME SOURCE®

Foaming Manual Dish Detergent

Lotionized dish washing liquid cleans even the greasiest dishes and glassware. Dries without spotting.

75004582 75004582 1 gal. 4/cs.
75004583 75004583 5 gal. 1/ea.

Dish Detergent

Lotionized dish, pot and pan detergent. Neutral PH, rinses freely, highly concentrated.

75004192 75004192 1 gal. 4/cs.



B. PINK DISH SOAP FOAMING MANUAL DISH DETERGENT PRIME SOURCE®

Cleans even the greasiest dishes and glassware. Lotionized, exceptional mildness to hands. Dries without spotting.

75004188 75004188 1 gal. 4/cs.
75004195 75004195 1 gal., Kosher 4/cs.
75004189 75004189 5 gal. 1/ea.



C. PREMIUM PLUS ULTRA BLUE DISH DETERGENT CONCENTRATE PRIME SOURCE®

Superior concentrate detergent has long-lasting action for use on the greasiest of soils.

Enriched formula is easy on the hands for extended use.

75004584 75004584 1 gal. 4/cs.
75004585 75004585 5 gal. 1/ea.



D. PRIME SOURCE® EXCEL DISHWASH DETERGENT PRIME SOURCE®

High-sudsing action. Deep cleans even the greasiest dishes, pots and pans.

75004157 75004157 1 gal. 4/cs.



E. PRIME SOURCE® FOAMY POT & PAN PINK LOTION DETERGENT PRIME SOURCE®

Gentle on hands. Can be used in a wide variety of applications.

75004186 75004186 1 gal. 4/cs.



F. PRIME SOURCE® LEMON DISH MANUAL DISHWASH DETERGENT PRIME SOURCE®

A low cost hand dishwash detergent designed to rinse freely without spots or streaks.

Performs in hard water and is gentle to skin. A.P.E. free. Lemon fragrance.

75004190 75004190 1 gal. 4/cs.
76008510 76008510 3.78 L 4/cs.



G. SILKY PINK HAND DISHWASH DETERGENT CARROLL

Economical, pink, lotionized dishwash. Gentle to the hands; abundant suds. Versatile product can be used in wide variety of applications. No fragrance added.

30010452 29928 1 gal. 4/cs.



H. GREEN WORKS® NATURALLY DERIVED MANUAL POT & PAN DISHWASHING LIQUID CLOROX

Hard on grease, gentle on hands. Made with gentle, biodegradable ingredients and cleans with the power you expect from The Clorox Company. Usage: commercial kitchens, office breakrooms, school cafeterias. 97% naturally derived. Cuts through grease and baked-on foods. No harsh chemical residue. Dermatologist tested. Leaves nothing but a natural, streak-free shine.

38380381 30381 38 oz. 8/cs.
38380388 30388 1 gal. 4/cs.

Hand Dishwash



A. AJAX® DISHWASHING LIQUID COLGATE-PALMOLIVE

Pink rose lotion dish detergent. For hand dish washing. Effective against grease. Pleasant rose fragrance.

11904616 14616 1 gal. 4/cs.



B. PALMOLIVE® DISHWASHING LIQUID COLGATE-PALMOLIVE

Original

Cuts through stubborn grease. Rich, thick formula removes dried-on, cooked-on food. pH balanced. Long-lasting performance makes it an economical choice. DfE approved formula. Ready-to-use.

11900047 20181 850 mL 12/cs.

11901640 04910 1 gal., Green 4/cs.

11901660 04911 5 gal., Green 1/ea.

Plus

Cuts through stubborn grease. Rich, thick formula removes dried-on, cooked-on food. pH balanced. Long-lasting performance makes it an economical choice. DfE approved formula. Ready-to-use.

11901702 01410 3³/₄ oz., Green 72/cs.

11900088 201417 3³/₄ oz., Green, Foaming 72/cs.

Antibacterial

One product does the work of two: a powerful, grease-cutting manual dishwashing liquid and an antibacterial liquid hand soap. Grease-cutting formula provides outstanding cleaning. Gentle pH formula is soft on hands. Proven antibacterial protection for the hands when used as hand soap. Ultra concentrated.

11904930 04930 1 gal. 4/cs.



C. ULTRA PALMOLIVE® COLGATE-PALMOLIVE

Original

Cuts through stubborn grease. Rich, thick formula removes dried-on, cooked-on food. pH balanced. Long-lasting performance makes it an economical choice.

11900087 46112 25 oz. 12/cs.

11907430 47430 64 oz. 6/cs.

Dishwash

Cuts through stubborn grease. Rich, thick formula removes dried-on, cooked-on food. pH balanced. Concentrated for long-lasting performance.

11906225 46225 25 oz., Fresh Green Apple 12/cs.

Antibacterial Dishwash/Hand Soap

Provides all the benefits of a dishwashing detergent and an antibacterial hand soap. When used to clean dishes, long-lasting suds have the power to clean even the greasiest pots and pans while still being soft on hands. Proven antibacterial protection when used as a hand soap. Kosher approved. Ultra concentrated.

11900032 47928 25 oz. 12/cs.

11900086 46113 25 oz., Orange Scented 12/cs.

Dishwash for Pots & Pans

Highly concentrated formula tackles the toughest foodservice dishwashing tasks. Ideal for use as a presoak. Great as a general all purpose cleaner, its grease-cutting ability makes it perfect for cleaning tables, countertops, windows, mirrors and more. Ocean Breeze scent. DfE approved formula.

11900056 40043 1 gal. 4/cs.



D. SUMA® SUPREME OPTIFILL POT & PAN DETERGENT DIVERSEY

Easy-to-use, maintenance-free manual warewashing program delivers accurate dilution without the need for equipment or permanent water connection. Designed for use in three-compartment sinks. A super-concentrated, high active formula that cuts through even the greasiest pots, pans and food prep utensils.

15200396 4977476 2.5 L 1/ea.



Hand Dishwash



A. SUNLIGHT® DIVERSEY

Lemon Fresh Dishwashing Liquid

Commercial and industrial use dishwashing liquid has a powerful formula producing thick, rich suds that cut through grease to leave dishes sparkling clean, while being gentle on hands. Recommended for institutional use. Ideal for use on the greasiest dishes, glassware, cutlery or pots and pans. pH-balanced for mildness. Super-concentrated, thick, high sudsing pot and pan formula.

15200573 5585968 1 gal. 4/cs.

Pot & Pan Dishwashing Liquid

Designed for institutional use. Ideal for the greasiest dishes, glassware, cutlery or pots and pans. pH balanced for mildness. Super concentrated, high active, high sudsing pot and pan formula.

15200155 2979486 3 oz. 90/cs.

15200117 2979460 5 gal. 1/ea.



B. POT & PAN DETERGENT KAY CHEMICAL COMPANY

Maximum grease-cutting performance with long-lasting suds. Powerful, concentrated formula is mild to hands. Effective general purpose cleaner on tables and equipment. Color-coded, icon-labeled packaging encourages correct use.

42551105 1105 2 gal. Bag 2/cs.



C. DAWN® MANUAL POT & PAN DETERGENT PROCTER & GAMBLE

Cuts the tough grease others leave behind. High surfactant formula seeks out greasy soil, cuts through it, surrounds the removed soil and lifts it out of your way. Optimal blend of five different surfactants provides the power to cut and emulsify grease.

16901735 21735 14 oz., Original 25/cs.

16905113 45113 38 oz., Lemon 8/cs.

16905112 45112 38 oz., Original 8/cs.

16902323 62323 1 gal., Closed Loop 3/cs.

16902619 02619 1 gal., Lemon 3/cs.

16902613 02613 1 gal., Original 3/cs.

16908077 08077 5 gal., Lemon 1/ea.

16900134 02611 5 gal., Original 1/ea.

Antibacterial

Cuts the tough grease others leave behind. High surfactant formula seeks out greasy soil, cuts through it, surrounds the removed soil and lifts it out of your way. Optimal blend of five different surfactants provides the power to cut and emulsify grease.

16902906 42906 38 oz., Orange 8/cs.



D. JOY® DISHWASHING LIQUID PROCTER & GAMBLE

Powerful surfactants to clean a wide variety of soils. Designed to be mild. High surfactant level to give a rich layer of suds and high suds mileage. Forms surfactant micelles that stay suspended in wash water to provide micro-reservoirs of reserve cleaning power.

Concentrated; use 1 to 3 fl. oz. per 10 gal. sink. Lemon scent.

16901737 21737 14 oz. 25/cs.

16905114 45114 38 oz. 8/cs.

16900131 02302 1 gal. 3/cs.

16908163 08163 5 gal. 1/ea.



E. ULTRA IVORY® CONCENTRATED DISHWASHING LIQUID PROCTER & GAMBLE

Ultra Ivory® dishwashing liquid can cut through grease to bring your dishes to their incredible best. Ultra Ivory® is proven to be gentler on hands than the original green dishwashing liquid. Its special formula won't remove the natural oils in your skin, giving you soft hands as well as sparkling dishes.

16905574 25574 24 oz. 10/cs.

Hand Dishwash/Bar Glass Sanitizers



A. PROFESSIONAL EASY-OFF® DISH DETERGENT RECKITT BENCKISER

Heavy-duty formula developed for manual washing of dishes, pots, pans and utensils. Long-lasting suds are tough on greasy soils but leave no soapy film or residue. Soaks stubborn soil-free without hard scrubbing. Concentrated formula is economical; makes up to 512 gal.
58340003 74381 1 gal. 4/cs.



HAND DISHWASH - POWDER

B. PRIME SOURCE® PINK SUDS HAND WASHING & ALL PURPOSE DETERGENT PRIME SOURCE®

High-sudsing; reduces redeposition of soil. Fast-rinsing saves time and money. Results in surfaces drying spot and streak-free. Biodegradable, so it's environmentally safe.
75004180 75004180 50 lb. 1/ea.
75004179 75004179 100 lb. 1/ea.

C. AJAX® ARCTIC® SYNTEX™ DISHWASHING BEADS COLGATE-PALMOLIVE

High-sudsing pink powder for hand cleaning dishes, pots, pans. Fast-dissolving, grease-cutting formula is free-rinsing and gentle on hands. Contains corrosion and tarnish inhibitors. Tableware is left clean and streak-free.
11901620 04368 25 lb. 1/ea.

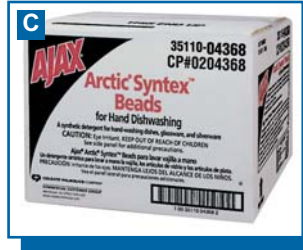

D. CREAM SUDS® POT & PAN PRESOAK & DETERGENT PROCTER & GAMBLE

Designed for soaking tough, baked-on foods from pots and pans. Effective on greasy soils. Can be used on wide variety of washable surfaces.
16908736 08736 25 lb., Phosphate 1/ea.
16908605 02120 25 lb., w/o Phosphate 1/ea.
16902101 02101 50 lb., Phosphate 1/ea.



BAR GLASS SANITIZERS

E. AJAX® SANITIZER/CLEANER POWDER COLGATE-PALMOLIVE

Super concentrated 1/4 ounces per 2 1/2 gal. of water. 8 lb. container makes 1,280 gal. of sanitizer solution. For third sink, clean in place, soft serve and presoak applications. Contains cleaning agents to remove milkstone from equipment surfaces. Contains chlorine as the active ingredient and is non-clumping. EPA Registration No. 10634-19-4582.
11904967 04967 8 lb. 1/ea.



F. BEER CLEAN® DIVERSEY

Low Suds Glass Cleaner - Electric Brush

For sparkling clean glassware and better tasting beer. Powdered compound cleans in hot-cold, hard or soft water. Concentrated formula for quick cleaning. Odorless detergent system provides excellent rinsing results. Low Suds for use with electric brushes.
15200096 90224 1/2 oz. Packets 100/cs.
15207650 90241 4 lb. 2/cs.

Glass Cleaner - Manual Brush

For sparkling clean glassware and better tasting beer. Powdered compound cleans in hot-cold, hard or soft water. Concentrated formula for quick cleaning. Odorless detergent system provides excellent rinsing results. Regular formula for manual brush cleaning.
15200094 90221 1/2 oz. Packets 100/cs.
15200092 90201 4 lb. 2/cs.

Last Rinse Sanitizer

Powdered compound contains trichloromelamine (TCM) for effective sanitizing of bar glassware. Laboratory tested to kill E.coli and Staph. Delivers 100 ppm available chlorine.
15200095 90223 1/4 oz. Packets 100/cs.
15200093 90203 25 oz. 2/cs.

Mineral Solvent

Serves as a "booster" in the water softening process—especially important in adjusting local water conditions. Ties up hard water minerals to obtain maximum cleaning results. Single use packet for better dilution control. NSF G6 Registered for steam table treatment.
15207630 90222 1/2 oz. 100/cs.



CHEMICALS

Bar Glass Sanitizers/Machine Dishwash



A. DIP-IT® COFFEEMAKER CLEANER RECKITT BENCKISER
Liquid cleaner dissolves and removes build-up of lime, calcium and other water deposits.
58346320 36320 7 oz. 8/cs.

MACHINE DISHWASH - LIQUID

B. PALMOLIVE® ECO+® LEMON SPLASH® COLGATE-PALMOLIVE
AUTOMATIC DISHWASHING DETERGENT
Automatic dishwasher detergent leaves your dishes sparkling clean. Dissolves quickly without caking. Eliminates spots and film often caused by powders.
11900007 42706 75 oz. 6/cs.

MACHINE DISHWASH - POWDER

C. PRIME SOURCE® FEATHER BEADS PRIME SOURCE®
HIGH SUDSING DISHWASHING DETERGENT
Economical and can be used in hot or cold, soft or hard water. Fast-rinsing; saves time and money. Biodegradable, so it's environmentally safe.
75004184 75004184 25 lb. 1/ea.

D. PRIME SOURCE® SUPER CHLOR PRIME SOURCE®
MACHINE DISH DETERGENT
Non-foaming, fast rinsing detergent. For use in automated dishwashers. Cuts through grease and fats. Removes dried-on foods and films.
75004183 75004183 25 lb. 1/ea.

E. PALMOLIVE® MACHINE COLGATE-PALMOLIVE
DISHWASHER DETERGENT
Automatic dishwasher detergent leaves your dishes sparkling clean. Powerful cleaning to remove dried-on, stuck-on food. Stain removal for tough stains like coffee and tea. Spot and film fighting agent to help rinse away residue leaving dishes virtually spot and film-free.
11904972 04971 200 ct., Triple Action Tabs 200/cs.

F. CASCADE® DISHWASHER DETERGENT PROCTER & GAMBLE
Specially formulated for under counter automatic dishwashing. Sheeting action for virtually spotless dishes.
16900933 00801 20 oz. 24/cs.
16900092 34034 45 oz., Powder Fresh 12/cs.
16909921 39921 85 oz. 6/cs.

ActionPacs™
Combines the scrubbing power of Cascade® with the grease-fighting power of Dawn® in a single-use pouch. The liquid and powder combination results in excellent shine and stain removal. No need to pre-wash.
16900038 41759 20 ct., Original 100/cs.

G. FINISH® POWDER DISHWASH DETERGENT RECKITT BENCKISER
Powder Dishwash Detergent
Deep cleaning power plus Shine Boost® to gently remove tough food stains. Powerful powder works quickly and completely to get your dishes sparkling clean.
58348234 78234 75 oz., Lemon Scent 6/cs.

PowerBall Automatic Dishwash Detergent 3-In-1 Tabs
3-in-1 Tabs with Jet-Dry® Powerball provides convenient pre-measured detergent without the mess of a liquid. Tabs contain special cleaning agents that remove the toughest food stains. Gently scrubs dishes while providing encapsulated Jet-Dry® water-soluble rinse agents that eliminate water spots.
58340919 77050 20 Tabs, Fresh 160/cs.

Rinse Additive/Sanitizing Solution/Delimer



RINSE ADDITIVE

A. FINISH® JET-DRY® RINSE AGENT RECKITT BENCKISER

Add Finish Jet-Dry to rinse away leftover food and detergent residues for sparkling dishes, glasses and cutlery.

58346848 36848 2 ct., Solid Lemon Scent 12/cs.



SANITIZING SOLUTION

B. PREMIUM PLUS ULTRA NO RINSE SANITIZER PRIME SOURCE®

No need to rinse. Perfect for third-sink operations. For use on food processing equipment and food contact surfaces.

75004586 75004586 1 gal. 4/cs.
75004587 75004587 5 gal. 1/ea.



C. PRIME SOURCE® SANI RINSE DISINFECTANT SANITIZER PRIME SOURCE®

Does not require potable water rinse for glassware and cooking utensils. EPA Registered; use dilution 1:512. *Check with us regarding availability/product registration status in your state.

75004020 75004020 1 gal. 4/cs.
75004021 75004021 5 gal. 1/ea.



D. AJAX EXPERT® LIQUID SANITIZER COLGATE-PALMOLIVE

Use in third sink for sanitizing warewashing items or in spray bottle for counters, tabletops and in-place equipment. No chlorine odor formula is effective in hard water up to 500 ppm. 1/4 oz. per gal. dilution; 1 gal. of concentrate makes 512 gal. of ready-to-use sanitizer solution. Multi-quat formula with FD&C red color. Deodorizes and leaves no residual odors. EPA Registration No. 6836-70-4582.

11904963 04963 1 gal. 4/cs.



E. FINAL STEP™ SANITIZER DIVERSEY

Recommended for use as a sanitizer in public eating places, and on dairy processing equipment and food processing equipment and utensils. This product will yield a concentration of 200 ppm active quat. With the dilution control system of Optifill™^{MC}, the job of sanitizing is done thoroughly and correctly—every time. Kosher certified. NSF D2 Listed. Red in color with a quaternary scent.

15200397 4603095 2.5 L, Optifill™ 1/ea.



F. CLEAN QUICK® LIQUID QUATERNARY SANITIZER PROCTER & GAMBLE

Quaternary, non-rinse sanitizer, sanitizes without leaving chlorine bleach odors. For third-sink sanitizing of dishes, glasses, silverware, and cooking utensils. Also use to sanitize hard (non-porous) surfaces, such as chopping blocks and countertops. Light pink color confirms product presence in third sink. 200 ppm active quaternary when diluted at 1 fl. oz. of sanitizer to 5½ gal. of water.

16907535 07535 1 gal., w/Test Strips 3/cs.



DISHMACHINE DELIMER

G. SUMA® LIME SCALE REMOVER DIVERSEY

Acid-based dishmachine delimer. Red in color with an acidic scent.

15205493 5325488 1 gal. 4/cs.





Laundry Detergent

CHEMICALS



LAUNDRY DETERGENT SHEETS

A. PUREX® COMPLETE 3-IN-1 LAUNDRY SHEETS DIAL

Purex® Complete 3-in-1 laundry sheets are a load's worth of detergent, softener and anti-static, all in one powerful sheet. Simply drop laundry sheet into washer, the detergent is released during the wash cycle. Once wash is complete, transfer the laundry sheet with clothes to dryer. The stripe is heat activated by the dryer to soften and remove static.

12800082 06176 38 ct., Tropical Escape 190/cs.

LIQUID LAUNDRY DETERGENT

B. GREEN WORKS® LIQUID LAUNDRY DETERGENT CLOROX

Dye-free, fragrance-free detergent is specially formulated for both standard and high-efficiency washers. Made with natural, plant-based cleaning ingredients that clean without leaving a harsh chemical residue on clothes. Dermatologist-tested and safe for sensitive skin and colors.

38380073 30319 90 oz. 4/cs.

C. ALL® ULTRA 2X LAUNDRY DETERGENT DIVERSEY

Ultra concentrated detergent, with Stainlifters™ to safely lift dirt and stains.

15201161 CB291161 256 Loads 4/cs.

D. WISK® LIQUID LAUNDRY DETERGENT DIVERSEY

Concentrated liquid attacks everything from protein stains to oily dirt. Use as a powerful stain pre-treatment or all purpose cleaner/degreaser. Provides optimum results on all fabrics in all wash conditions.

15200180 2979945 2 oz., Coin Vend Pack 100/cs.

15200130 2979890 1 gal., Heavy-Duty 4/cs.

E. TIDE® 2X LIQUID LAUNDRY DETERGENT PROCTER & GAMBLE

2X concentrated to give you twice the stain-fighting power in every drop. You get the same number of loads in a smaller, more convenient bottle. Plus the new formula removes stains better than before. One small cap gets your clothes beyond clean, it gets them ultra clean. Dye and perfume-free. For sensitive skin.

16903878 13878 50 oz. 6/cs.

16907116 13882 100 oz., 64 Loads 4/cs.

16908886 08886 100 oz., 64 Loads, Tide Ultra 4/cs.

POWDER LAUNDRY DETERGENT

F. PRIME SOURCE® CARALO LAUNDRY DETERGENT PRIME SOURCE®

Controlled suds laundry detergent. Contains brightening and whitening agents. For automatic and non-automatic machines.

75004171 75004171 50 lb. 1/ea.

G. PRIME SOURCE® LOW SUDS II LAUNDRY DETERGENT PRIME SOURCE®

Penetrate soils for effective cleaning. Safe to use; formulated to clean, preserves fabric life. Economical; cleans thoroughly and rinses quickly, meaning no need for extra rinses. Biodegradable, so it's environmentally safe.

75004172 75004172 50 lb. 1/ea.

H. ALTA LAUNDRY DETERGENT CARROLL

Economical, non-phosphoric, controlled suds, free flowing detergent. Contains brightening and whitening agents for automatic washing machines. All temperature, all machine types; water soluble detergent. Lemon fragrance.

30011110 91110 50 lb. 1/ea.

Laundry Detergent/Bleach



A. ULTRA PUREX® DRY LAUNDRY DETERGENT DIAL

Whitens and brightens clothes. Helps prevent dinginess. Enhanced blend of surfactants and builders performs well in all temperatures and leaves clothes with a fresh, clean scent. Color Shield® protects colors from fading. Biodegradable. Phosphate-free.

15201837 01837 80 Use, 107 oz. Box 3/cs.



B. ALL® DIVERSEY

Ultra Powder Laundry Detergent

Formulated with Stainlifters™ to lift out tough dirt and oily stains. Excellent in all water temperatures. Designed for the vending opportunities in laundromats and guest amenities.

15200115 2979267 (100) 2 oz., Coin Vend Pack 100/cs.

15200176 2979304 150 Use 1/ea.

Multi-Purpose Detergent

Lifts out tough dirt and oily stains. Low sudsing. Performs at all temperatures. HE formula suitable for use in both front load and top load machines. Can also be used on floors, concrete pads and other surfaces. Contains no phosphorus.

15200113 2979232 17 lb., Flip Top Pail 1/ea.

Concentrated Powder Laundry Detergent

For large laundry loads. Quality performance, yet low cost per use. High efficiency formula is suitable for use in front load and top load machines. Effective in all water temperatures. Excellent stain lifter. Biodegradable. Contains no phosphorus.

15200112 2979216 50 lb., Concentrated 1/ea.



C. SURF® ULTRA POWDER DETERGENT DIVERSEY

Unique, heavy-duty detergent attacks stubborn dirt and controls odors. "Active Oxygen" formula lifts dirt and stains, and works in all temperatures.

15200158 2979814 2 oz., Coin Vend Pack 100/cs.



D. TIDE® DRY LAUNDRY DETERGENT PROCTER & GAMBLE

Dry

Tide® dry laundry detergent with hydrogen peroxide. High-powered, grease-cutting formula effective on tough, greasy food stains.

16902280 42280 263 oz. 2/cs.

Ultra Powder

Exceptional cleaning power and a new grease releasing formula that's effective even on tough, greasy food stains. Removes tough dirt, low suds for easy rinsing. Safe for septic tanks.

16900230 27782 20 oz., Original Scent, 15 Loads 15/cs.

w/Bleach Powder

Contains a unique active bleaching system. Removes many tough stains and whitens whites. Helps keep colors bright. No phosphate. Harmless to septic tanks. Kills 99.9% bacteria (effective against Staphylococcus aureus and Klebsiella pneumoniae; use as directed).

16901801 02370 4 oz. 100/cs.

16900232 27810 21 oz. 15/cs.

16900233 27807 171 oz. 2/cs.



BLEACH

E. CLOROX® BLEACH PEN CLOROX

Treat stains as they happen! Get the power of Clorox® bleach in an easy-to-hold, portable stain removal tool. The Clorox® Bleach Pen® Gel is your best friend in the laundry room and on the go. Its dual-tipped applicator has a fine point for precise jobs and a scrub brush for larger ones - no more stains on white, white-and-color striped, floral and patterned clothes. Handy outside the laundry room too: it can wipe out even the toughest of bathroom and kitchen stains, like mold and mildew, coffee, tea, berry juice and red wine.

38384690 04690 2 oz. 12/cs.



Bleach



A. CLOROX® LIQUID BLEACH

CLOROX

Remains the most trusted brand of bleach for a cleaner home and the whitest of laundry whites. Day-to-day use can affect even the brightest of whites. Keep your whites as white as they can be with Clorox® Regular-Bleach. Provides unbeatable whitening for your fabrics while removing body soil, stains and dirt that detergent can leave behind. Helps reduce the spread of germs in your home by killing common viruses, bacteria and fungi that can make your family sick.

38382450	02450	24 oz.	12/cs.
38382510	02510	60 oz.	8/cs.
38382467	02467	96 oz., Clean Linen Scent	6/cs.



B. CLOROX® GERMICIDAL BLEACH

CLOROX

Whitens. Removes stains. Disinfects. In your home, Clorox® Regular-Bleach helps reduce the spread of germs by killing common viruses, bacteria and fungi that can make your family sick. In the laundry room, it works better than detergent to remove tough stains like coffee, grass, red wine, ballpoint ink, berry juice and even spaghetti sauce.

38382491	02490	96 oz.	6/cs.
38382489	02489	182 oz.	3/cs.



C. ULTRA CLOROX® GERMICIDAL BLEACH

CLOROX

Cleans, disinfects and deodorizes a variety of surfaces. For nearly 100 years, bleach has been the number one choice for hard-surface disinfection and is recommended by CDC guidelines to disinfect contamination caused by hard-to-kill pathogens like Norovirus. When combined with hand sanitizing efforts, regular disinfection with bleach-based cleaners can help break the pathogen transmission cycle and help keep your facility a healthier place. The gold standard in disinfecting with 38 kill claims, including C. diff, MRSA, VRE, Norovirus and more. At 6.15% sodium hypochlorite, more concentrated than most products on the market. Safe for use on exam tables, equipment surfaces, mobile devices and more. Number one choice for hard-surface disinfection. EPA-registered to kill C. difficile spores. Registered to kill more bacteria and viruses than other leading bleaches.

38382440	02452	96 oz.	6/cs.
-----------------	-------	--------	-------



D. BORATEEM® CHLORINE-FREE COLOR SAFE POWDER BLEACH

DIAL

Improved formula helps keep clothes looking newer longer by whitening whites, brightening colors, removing stains and fighting dinginess. Advanced stain remover. Color Seal helps prevent fading. Works well in all temperatures. Uses biodegradable cleaning agents. Advanced lightweight formula in same 5 gal. pail is three times lighter, yet still washes 160 loads.

12808060	00145	16 lb.	1/ea.
-----------------	-------	--------	-------



E. DRY CHLORINE BLEACH

DIVERSEY

Removes stains and brightens whites. Designed for the vending opportunities in laundromats and guest amenities.

15200123	2979646	2 oz., Coin Vend Pack	100/cs.
-----------------	---------	-----------------------	---------

Stain Removers/Fabric Softeners



STAIN REMOVERS

A. SHOUT® DIVERSEY

Wipes

Pre-moistened towelette instantly reduces stains. Cuts grape juice, coffee, blood and baby formula. Pre-treat stains on clothing, even during wear. Safe on colorfast washable and drycleanable fabrics. Individually wrapped towelettes are convenient and portable.

15200104 CB022460 12 ct., 4⁷/₁₀" x 5⁹/₁₀" 12/cs.

15200171 94354 80 ct., 4⁷/₁₀" x 5⁹/₁₀" 80/cs.

Laundry Stain Remover

Combines the cleaning power of lemon with other powerful stain fighters to quickly penetrate, break-up and eliminate the toughest, greasiest stains. Effective on motor oil, grass, blood and other protein-based stains. Safe for all colorfast washables.

15200137 CB022514 20 oz., Trigger Sprayer 12/cs.



B. TIDE® TO GO STAIN REMOVER PEN PROCTER & GAMBLE

Eliminates most stains on clothing. Convenient to use. For immediate stain removal and pre-treat applications.

16900458 84950458 10 mL 6/cs.



C. SPRAY 'N WASH® RECKITT BENCKISER

LAUNDRY STAIN REMOVER

Specially formulated with powerful stain fighting ingredients to eliminate the toughest stains. Safe for all colorfast washables. Works in all temperatures.

58340230 00230 22 oz., Trigger Sprayer 12/cs.

FABRIC SOFTENERS

D. SNUGGLE® FABRIC SOFTENER DIVERSEY

Sheets

Convenient dryer sheets reduce static cling and leave clothes soft and fresh. Cuddle-up fresh scent. Designed for the vending opportunities in laundromats and guest amenities.

15200132 2979929 2 Sheets, Coin Vend Pack 100/cs.

Liquid

Liquid fabric softener for the wash cycle gives clothes a special freshness while reducing static cling. Cuddle-up fresh scent. Designed for the vending opportunities in laundromats and guest amenities.

15200136 2979996 1 1/2 oz. 100/cs.

Concentrated Liquid

Concentrated, professional formula liquid fabric softener for the wash cycle gives clothes a special freshness while reducing static cling. Cuddle-up fresh scent.

15200134 2979953 2 gal., w/Pump 2/cs.



E. BOUNCE® DRYER SHEETS PROCTER & GAMBLE

Helps reduce static cling on garments as they come out of the dryer and as they are worn. Time released freshness. Softness you can feel. Outdoor fresh scent.

16907267 10038 25 ct. 375/cs.

16907270 37270 160 ct. 160/cs.



F. DOWNY® FABRIC SOFTENER PROCTER & GAMBLE

Liquid fabric softener. April Fresh scent. Rinse-added fabric softener for fluffy softness. Helps reduce static cling.

16900147 20930 19 oz., 23 Loads 6/cs.

16905762 35762 51 oz. 8/cs.

16906447 06447 64 oz. 8/cs.



Aerosol Disinfectants



AEROSOL DISINFECTANTS

A. PRIME SOURCE® HOSPICIDE DISINFECTANT SPRAY PRIME SOURCE®

Hospital grade disinfectant. Kills HIV-1 and Herpes. Can be used as a deodorant air freshener. EPA registered. *Check with us regarding availability/product registration status in your state.

75004033 75004033 15 oz. 12/cs.
76000764 76000764 440 g 12/cs.



B. PRIME SOURCE® SCRUBBLES FOAMING DISINFECTANT CLEANER PRIME SOURCE®

Quaternary foaming cleaner and deodorant. Use on all restroom fixtures as well as vinyl and leather. Effective on mold and mildew. EPA registered. *Check with us regarding availability/product registration status in your state.

75004034 75004034 18 oz. 12/cs.



C. GERMICIDAL CLEANER CLAIRE

This is a foaming all purpose cleaner that cleans, disinfects and deodorizes all in one easy step. Spray it on and wipe it off. Cleans and disinfects without scouring or scratching surfaces. Kills most germs, Bactericidal, Staphylocidal, Pseudomonicidal and Virucidal. Will disinfect Influenza A2/Japan Virus and Herpes Simplex Virus Types 1 and 2 on hard inanimate non-porous environmental surfaces. EPA registered.

25950873 CL873 20 oz., Floral 12/cs.



D. DISINFECTANT SPRAY FOR HEALTH CARE USE CLAIRE

Tuberculocidal. Disinfects HIV-1 (AIDS virus) on inanimate environmental surfaces. Also disinfects Herpes Simplex Virus Types 1 and 2 on inanimate environmental surfaces. In addition, carries all claims listed for other disinfectant sprays. For use in health care settings such as hospitals, nursing homes, schools, and institutions.

25950015 CL015 20 oz. 12/cs.



E. CLOROX® DISINFECTING SPRAY CLOROX

EPA-registered to kill 64 different microorganisms, more than the other leading disinfecting spray. Kills relevant bacteria, viruses and fungi that can cause serious illness and infection. Extensive kill claims and faster kill times while deodorizing and actually eliminating the bacteria that cause bad odors. Disinfects and deodorizes in one labor-saving step. Kills and prevents the growth of mold, protecting surfaces from discoloration or damage, saving you time and money later. Safe to use on a wide variety of hard surfaces.

38388504 38504 19 oz. 12/cs.



F. END BAC® II SPRAY DISINFECTANT DIVERSEY

A quaternary-based aerosol germicide for disinfecting pre-cleaned surfaces. Fungicidal and tuberculocidal. Controls mold and mildew.

15204832 04832 15 oz. 12/cs.

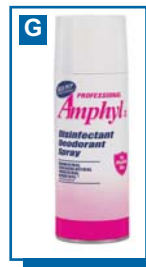

G. PROFESSIONAL AMPHYL® III DISINFECTANT DEODORANT SPRAY RECKITT BENCKISER

Kills 99.9% of germs. Effective against the H1N1 strain of Influenza A and the Influenza A virus. Effective disinfectant that kills odor-causing bacteria at their source. Tuberculocidal, virucidal, fungicidal and bactericidal. Effective against MRSA, Norovirus, Rhinovirus, HIV-1 (AIDS Virus), Poliovirus Type 1 and Hepatitis A.

58348300 08300 13 oz. 12/cs.

Aerosol & Liquid Disinfectants



A. LYSOL® RECKITT BENCKISER

Brand I.C.™ Foaming Disinfectant Cleaner

Ready-to-use quaternary formula cleans, disinfects and deodorizes. Contains no harsh acids, abrasives or bleach. Meets AOAC efficacy standards for hospital aerosol disinfectants. NSF Category Code C2.

58345524 95524 24 oz. 12/cs.

Brand II Disinfectant Spray

Kills viruses, bacteria, mold, and mildew. Eliminates odors. Kills 99.9% of germs in seconds.

58342922 02922 12 oz., Summer Breeze 12/cs.

Brand III I.C.™ Disinfectant Spray

Tuberculocidal, virucidal, fungicidal and bactericidal and kills 99.9% of germs on hard, nonporous surfaces, including MRSA, Norovirus, Hepatitis A Virus, Hepatitis B Virus, HIV 1 (AIDS Virus), Pandemic 2009 H1N1 Influenza A virus and is effective against over 50 microorganisms. The CONTROL FLO™ valve produces a wetter spray, enhancing surface coverage. This product meets CDC, EPA and OSHA Bloodborne Pathogen Standards. Use on showers, sinks, door handles, waiting rooms, sick rooms, laboratories and around toilet areas.

58345029 95029 19 oz. 12/cs.



B. PROFESSIONAL LYSOL® RECKITT BENCKISER

Brand III Disinfectant Spray

This tuberculocidal, virucidal, fungicidal and bactericidal formula kills 99.9% of germs on hard, nonporous surfaces and is effective against over 50 microorganisms including H1N1 (Influenza A virus) MRSA, Norovirus, Rhinovirus, Poliovirus Type 1, Hepatitis A virus, Hepatitis B virus and HIV-1 (AIDS Virus). This product eliminates odors and prevents the growth of mold and mildew. Use on showers, sinks, countertops, around toilet areas, toys, telephones, garbage bins, waiting rooms and in laboratories.

58344185 74185 6 oz., Crisp Linen 12/cs.

58342845 02845 12 oz., Spring Waterfall 12/cs.

58344276 74276 19 oz., Country 12/cs.

58344828 74828 19 oz., Crisp Linen 12/cs.

58344675 04675 19 oz., Fresh 12/cs.

58344650 04650 19 oz., Original 12/cs.

58346075 76075 19 oz., Spring Waterfall 12/cs.

Kills 99.9% of germs on hard, non-porous surfaces within 30 seconds. Formula is tuberculocidal, virucidal, fungicidal and bactericidal. Effective against HIV-1 (AIDS virus), Poliovirus Type 1 and Hepatitis A. Prevents odors and growth of damaging mold and mildew. Meets AOAC germicidal spray product test standards for hospital aerosol disinfectants. Meets the requirements for the OSHA Bloodborne Pathogens Standard for Decontamination. NSF Category Code C1.

58344186 74186 12 oz., Crisp Linen 12/cs.

Disinfectant Foam Cleaner

Kills Staph, Salmonella, Pseudomonas, HIV-1 (AIDS virus) and other harmful germs on hard, non-porous surfaces (hospital disinfection). Rich foam clings to vertical surfaces. Unique aerosol valve allows spraying from any position, even upside down. Cleans, shines, disinfects and deodorizes. Contains grease cutting agents. Prevents growth of damaging mold and mildew. NSF Category Code C2, Reg. No. 123478.

58345080 02775 24 oz. 12/cs.



C. QUAT DISINFECTANT & DEODORIZER ZEP

Aerosol quat disinfectant deodorizer and cleaner. Powerful clinging foam is ideal for all hard surfaces such as bathroom fixtures, floors and tables. Pleasant fresh fragrance.

75070035 R02501 20 oz. 12/cs.

LIQUID DISINFECTANTS

D. MINT KLEANS DISINFECTANT CLEANER PRIME SOURCE®

Deodorizing disinfectant cleaner with a fresh mint fragrance. Dilutes at 5 oz. per gal. for cleaning and disinfection. EPA registered.

75004026 75004026 1 gal. 4/cs.

75004027 75004027 5 gal. 1/ea.

75004028 75004028 55 gal. 1/ea.



Liquid Disinfectants



A. PRIME SOURCE® NU QUAT NEUTRAL HOSPITAL GRADE DISINFECTANTS **PRIME SOURCE®**
 Exceptional cosmetic grade fragrance. Kills HIV-1 (AIDS virus), MRSA, VRSA and VRE. EPA registered. *Check with us regarding availability/product registration status in your state.
75004023 75004023 1 gal. 4/cs.
76008530 76008530 3.78 L, Lemon 4/cs.
76008527 76008527 3.78 L, Pine 4/cs.
76008528 76008528 18.9 L, Pine 1/ea.

B. BREEZE RTU DISINFECTANT CLEANER **CARROLL**
 Non-acid quat formula, won't harm metal/restroom surfaces. Hospital grade foaming cleaner, HIV claim. One step clean and deodorize for bath and bowl. Citrus fragrance.
30010443 70223 1 qt. 12/cs.

C. CLEANERS/DISINFECTANTS **CARROLL**
 Quat-based formula, hospital use plus HIV claim. Excellent neutral cleaner on washable hard surfaces. Will not dull detergent resistant floor finishes.
30010222 77628 1 gal., Clear Lemon 4/cs.
30010209 75628 1 gal., Clear Mint 4/cs.
30013628 73628 1 gal., Clear Pine 4/cs.

D. MULTI-Q® DISINFECTANT SANITIZER **CARROLL**
 Broad spectrum sanitizer and hospital grade disinfectant. No-rinse sanitizing for food contact surfaces. Disinfects against VRSA, MRSA, HBV, HIV. Colorless; odorless; USDA D2, Q3.
30010201 75028 1 gal. 4/cs.

E. OMNI-Q HOSPITAL GRADE DISINFECTANT CLEANER **CARROLL**
 Quat-based formula, broad spectrum, hospital grade. Effective against Tuberculosis (TB), HIV, Parvo, and E. Coli. Non-acid bathroom cleaner; safe on most hard surfaces. Unique, fresh fragrance. USDA D-1.
30010199 73123 1 qt. 12/cs.

F. PINE II® PINE ODOR DISINFECTANT **CARROLL**
 Leaves the pleasant, but not overpowering, deodorizing fragrance of pine. Combines the known and proven disinfecting properties of a phenolic germicide and the deodorizing abilities of pine oil to provide the desired qualities for use in most restroom sanitation programs. EPA registered, USDA C-1.
30010225 79028 1 gal. 4/cs.

G. CLOROX® Commercial Solutions® Germicidal Spray **CLOROX**
 Effective against a wide range of microorganisms and engineered to meet the disinfecting needs of today's busy healthcare professionals. Provides real-world kill and contact times, convenient application methods, and a one-year shelf-stable, bleach-based formula. One minute contact kills Rotavirus, E. coli, Staphylococcus aureus, and HIV type 1. Contains 1:10 bleach solution recommended by the CDC in a ready-to-use formula.
38385310 35310 32 oz. 9/cs.

Clean-Up® Disinfectant Cleaner w/Bleach
 Powerful cleaning and disinfecting for tough stains. Combines cleaning, disinfecting and stain removal in one product. Eliminates odors caused by bacteria, mold and mildew. Safe to use on most nonporous surfaces. Deodorizes surfaces and has a clean, fresh scent.
38381266 35417 32 oz. 9/cs.
38381250 35420 1 gal. 4/cs.

Pro Quaternary All Purpose Disinfectant
 An important line of defense against both MRSA and community-associated MRSA (CA-MRSA). This product combines powerful cleaning and hospital-grade disinfecting in a no-rinse formula. Safe for use on multiple surfaces such as stainless steel, sealed granite, shower stalls and glazed ceramic tiles. Product is pH-neutral so it will not dull high-gloss floor finishes.
38380180 30423 1 gal. 2/cs.

Liquid Disinfectants



A. DISPATCH® HOSPITAL CLEANER DISINFECTANT W/BLEACH CLOROX

Fast-acting cleaner disinfectant. A unique, stabilized sodium hypochlorite and detergent solution that kills pathogens fast. EPA registered to kill *C. difficile* spores in five minutes. Formulated with 1:10 bleach solution strength that is recommended by CDC guidelines for effective disinfecting. Meets OSHA bloodborne pathogen standards. Cleans and disinfects in one step. Ready-to-use.

38388832	68832	32 oz. Pull Top	6/cs.
38388970	68970	32 oz. Trigger Spray Bottle	6/cs.
38388978	68978	128 oz. Refill Bottle	4/cs.



B. PINE-SOL® MULTI-SURFACE CLEANER CLOROX

Work as hard as you do to keep your home clean. Leaves a fresh lemon scent. Pine-Sol® Multi-Surface Cleaner has helped generations of moms clean and disinfect their homes. Leaves behind a refreshing, long-lasting lemon scent, but it still cuts through the toughest stains, grease and grime. You can keep your whole home, from the kitchen to the bathroom to the garage, sparkling and smelling clean all week long. Safe on wood.

38380239	40239	60 oz., Lemon Fresh Scent	6/cs.
-----------------	-------	---------------------------	-------



C. AJAX EXPERT® DISINFECTANT CLEANER/SANITIZER COLGATE-PALMOLIVE

One step process to clean, disinfect and sanitize. Use as a fungicide, mildew stat, and virucide. Sanitizer inhibits the growth of mold and mildew and their odors. Effective against a broad spectrum of bacteria. 1 gal. of concentrate makes 64 gal. of ready-to-use solution. Does not contain phosphorous. EPA Registration No. 61178-1-4582.

11904117	04117	1 gal.	2/cs.
-----------------	-------	--------	-------

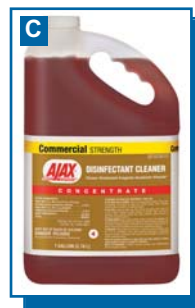

D. OXIVIR® TB DISINFECTANT DIVERSEY

A ready-to-use disinfectant cleaner based on proprietary hydrogen peroxide (AHP®) technology to deliver fast, effective cleaning performance. Disinfects in 60 seconds. Virucide, bactericide, tuberculocide, fungicide and non-food contact sanitizer. Kills MRSA and Norovirus. Meets bloodborne pathogen standards for decontaminating blood and body fluids.

15207285	4277285	32 oz.	12/cs.
-----------------	---------	--------	--------



E. VIREX® TB GERMICIDAL CLEANER DEODORANT DIVERSEY

Ready-to-use formula provides excellent cleaning, disinfecting and deodorizing in one step. Patented quaternary formula kills TB and HIV-1 so it meets OSHA's Bloodborne Pathogen clean-up standard. Much less corrosive than phenolics or bleach. EPA registered.

15204743	4743	32 oz.	12/cs.
-----------------	------	--------	--------



F. PROFESSIONAL AMPHYL® HOSPITAL BULK DISINFECTANT CLEANER RECKITT BENCKISER

Economical, concentrated phenolic-based disinfectant that dilutes 1:100 for broad-spectrum use and 1:50 for hospital disinfection. Virucidal, fungicidal, germicidal and tuberculocidal. Sanitizes laundry, linens, blankets and cloth diapers. Prevents odors and growth of mold and mildew. NSF Category Code C2, Reg. No. 123485.

58340014	02500	1 gal.	4/cs.
-----------------	-------	--------	-------



G. LYSOL® I.C.™ QUATERNARY DISINFECTANT CLEANER RECKITT BENCKISER

Hospital disinfectant cleans and disinfects hard, non-porous surfaces. Economical, concentrated formula makes up to 256 gal. Virucidal, fungicidal and bactericidal. Multi-purpose, neutral pH, germicidal detergent and deodorant. EPA Registration No: 47371-129-675.

58344983	74983	1 gal.	4/cs.
-----------------	-------	--------	-------



Liquid Disinfectants/Restroom Cleaners



A. PROFESSIONAL LYSOL® RECKITT BENCKISER

Disinfectant Deodorizing Cleaner

Kills Staph, Strep and HIV-1 (AIDS virus). Prevents odors and growth of damaging mold and mildew. Cleans, disinfects and deodorizes. Economical, concentrated formula makes up to 64 gal. (1:64).

58346185 76185 1 gal., Fresh 4/cs.
58346334 76334 1 gal., Lemon 4/cs.

Disinfectant Pine Action® Cleaner

Economical, concentrated formula makes up to 64 gal. (1:64) and can be used for a variety of needs to clean, disinfect and deodorize. Use on floors, sinks, bathtubs, shower stalls, garbage pails, woodwork, glazed tile, walls and countertops.

58342814 02814 1 gal. 4/cs.



B. SIMPLE GREEN® D SIMPLE GREEN

Pro 3 One-Step Germicidal Cleaner & Deodorant

High concentrate that must be diluted prior to use. Fresh herbal pine scented hospital-grade germicidal cleaner. Effective against gram+ and gram- bacteria, HIV-1, Influenza A and more. Used for cleaning, disinfecting and deodorizing hard, non-porous surfaces.

73430301 30301 1 gal. 6/cs.
73430305 30305 5 gal. 1/ea.

Pro 5 One-Step Disinfectant

Also works as a cleaner, sanitizer, fungicide, mildewstat, virucide, and deodorizer. For bacterial disinfection, heavy-duty cleaning, and sanitation of non-food contact surfaces. No added color or fragrance. Effective against MRSA, Hepatitis B and C, Avian Influenza and much more. Bloodborne pathogen compliant.

73430501 30501 1 gal. 4/cs.
73430505 30505 5 gal. 1/ea.



C. BROAD SPECTRUM DISINFECTANT CLEANER ZEP

Environmentally preferred, ready-to-use germicidal cleaner and deodorant. Effective on mold and mildew. Conforms to CDC blood borne pathogen procedures for environmental services. Kills Parvo, Tuberculosis, HIV-1, MRSA, and Staph.

75070031 R02301 1 qt. 12/cs.
75070032 R02324 1 gal. 4/cs.



D. LEMON DISINFECTANT DEODORIZING CLEANER ZEP

Concentrated quat-based cleaner and deodorizer. Cleans, disinfects and deodorizes in one easy step. Leaves a pleasant lemon fragrance.

75070029 R02201 1 qt. 12/cs.



E. LEMONGRASS SANITIZER & CLEANER W/PEROXIDE ZEP

Concentrated, all purpose hard surface cleaner and sanitizer. Uses peroxide to clean and brighten. Safe for most hard surfaces.

75070033 R02424 1 gal. 4/cs.



RESTROOM CLEANERS

F. PRIME SOURCE® ARREST FOAMING RESTROOM CLEANER PRIME SOURCE®

Phosphoric acid cleaner for all restroom surfaces. Quick release foam clings to surface, rinses easily. Removes lime, scale and calcium deposits.

75004041 75004041 32 oz. 12/cs.



G. ENVIROPATROL® RESTROOM CLEANER CARROLL

Use as a high performance washroom general purpose cleaner. Concentrated cleaner for removal of soap scum, mildew, lime, water scale and rust deposits on porcelain, tile, ceramic tile and fiberglass surfaces. Safe for daily use on painted surfaces, porcelain, porcelain enamel, aluminum or stainless steel without etching or damaging them. Dilutes at 1 oz./gal. (1:128) for most applications. Cold water effective.

30014402 44028 1 gal. 4/cs.

Restroom Cleaners



A. CLOROX® DISINFECTING BATHROOM CLEANER CLOROX

Disinfects and deodorizes bathrooms. Kills germs and leaves bathrooms shining. Eliminates 99% of bacteria in and around the bathroom. Specially formulated to dissolve soap scum on contact. Leaves your bathroom smelling fresh and clean. Patented alkaline formula.

38387932 16930 30 oz. 9/cs.
38386038 16931 64 oz. 6/cs.



B. GREEN WORKS® NATURALLY DERIVED BATHROOM CLEANER CLOROX

Contains powerful cleaning agents that quickly clean tough stains such as soap scum, hard water and rust. Made with plant-based, biodegradable cleaning ingredients. Cleans with no harsh chemical fumes or residue and is never tested on animals. Works on multiple surfaces throughout bathrooms, including counters, chrome, sinks and toilets.

38380452 00452 24 oz. 12/cs.



C. ANTIBACTERIAL SCRUBBING BUBBLES® BATHROOM CLEANER DIVERSEY

Antibacterial foaming action thoroughly cleans, shines, sanitizes and deodorizes—without scrubbing! Attacks soap scum, hard water stains and dirt. Controls mildew. Kills common germs such as Staphylococcus aureus and E. coli. Won't scratch surfaces; leaves a brilliant shine. Not for use on acrylic, brass or natural marble surfaces. Multi-surface: can be used to clean tubs, showers, basins, glazed ceramic tile, stainless steel, chrome, fixtures, fiberglass and glazed porcelain surfaces.

15204308 94308 25 oz. 12/cs.



D. COMET® DISINFECTING BATHROOM CLEANER PROCTER & GAMBLE

Dissolves tough soap scum and hard water stains. A patented, non-abrasive, full-strength spray cleaner for common restroom surfaces. Solvents and surfactants penetrate and dissolve tough soap scum and hard water stains without scrubbing. Product is a medical environment disinfectant that kills a broad spectrum of germs including Salmonella, Staphylococcus, Pseudomonas, and odor-causing bacteria including Proteus Mirabilis and E. coli. EPA Registration No. 3573-54.

16908174 01105 32 oz. 8/cs.
16900192 01106 1 gal. 3/cs.



E. LYSOL® BATHROOM CLEANER RECKITT BENCKISER

Foaming action removes soap scum and dirt. Cleans, shines and disinfects washable bathroom surfaces and fixtures.

58342569 02569 24 oz. 12/cs.



F. PROFESSIONAL LYSOL® HEAVY-DUTY BATHROOM CLEANER RECKITT BENCKISER

Hospital disinfectant cleaner for all restroom cleaning needs. Deep cleaning action penetrates tough soils including body oils and soap scum. Cleans, disinfects and deodorizes with a fresh lime scent. Makes up to 32 gal. for general cleaning and disinfection (broad-spectrum disinfectant at 1:32). Makes up to 8 gal. for heavy-duty cleaning and hospital disinfection (hospital disinfection at 1:8). EPA Registration No. 675-54.

58344201 94201 1 gal. 4/cs.



G. VANI-SOL® BULK WASHROOM CLEANER RECKITT BENCKISER

Versatile, ready-to-use, heavy-duty disinfectant cleaner. Cleans and shines with no harsh abrasives. Controls the growth of mold and mildew stains. Kills Staph and Strep germs and athlete's foot fungus. NSF Category Code C2.

58340294 00294 1 gal. 4/cs.



Restroom Cleaners/Tile/Delimer



A. SIMPLE GREEN® CLEAN BUILDING™ BATHROOM CLEANER CONCENTRATE **SIMPLE GREEN**
 Specifically formulated for cleaning scale and scum types of soils typically found on hard bathroom surfaces. Pink color makes it easily identified when diluted into secondary containers. Safe to use on washable hard surfaces such as ceramic, glazed tile, Corian®, Formica, grout, faucets and fixtures, porcelain, and cured fiberglass. Non-toxic, biodegradable, non-caustic, and non-flammable. Makes 21 gal. of ready-to-use cleaner.
73431101 11101 1 gal. 2/cs.



B. ALL PURPOSE ACID BATHROOM CLEANER **ZEP**
 Mineral acid formulation removes rust, scum, and hard water deposits from most bathroom surfaces including porcelain, ceramic, chrome, aluminum, and stainless steel. Safe and effective for use on toilet bowls, tile, sinks, showers, and bathroom fixtures. Water dilutable for large surface application. Fights odor causing bacteria. Can be applied with a foam gun. Angle neck bottle.
75070002 R00001 1 qt. 12/cs.



C. PRIME SOURCE® DELIMER CLEANER **PRIME SOURCE®**
 Safely and effectively removes lime scale buildup. Non-flammable, biodegradable and rinse-free.
75004077 75004077 1 gal. 4/cs.



D. PRIME SOURCE® DESTROY SOAP SCUM REMOVER **PRIME SOURCE®**
 Use on shower stalls, terrazzo, tile, slate tubs and sinks. Chemically removes soap scum and hard water deposits.
75004016 75004016 1 gal. 4/cs.



E. PRIME SOURCE® SOFTY CRÈME CLEANER ND **PRIME SOURCE®**
 Bacteriostatic liquid for cleaning and polishing of metal, porcelain and other hard surfaces. High viscous; free-rinsing. Extra soft abrasive cleaner for added safety.
75004045 75004045 32 oz. 12/cs.



F. PRIME SOURCE® SOFTY DISINFECTANT CRÈME CLEANER **PRIME SOURCE®**
 Bacteriostatic liquid for cleaning and polishing of metal, porcelain and other hard surfaces. High viscous; free-rinsing. Extra soft abrasive cleaner for added safety.
76008503 76008503 946 mL 12/cs.



G. LIME OFF® HEAVY-DUTY DELIMER **CARROLL**
 Concentrated cleaner designed especially for dishwashing machines. Safely and effectively dissolves and removes lime scale build-up. Also removes lime scale and stain build-up on other kitchen equipment. Green color; no fragrance added; USDA A3.
30017528 37528 1 gal. 4/cs.



H. SUDSING CREAM CLEANSER **CARROLL**
 Non-acid, mildly alkaline, thick, clinging cleanser. Contains fine grit pumice for scrubbing power. Will not scratch porcelain or porcelain enameled surfaces. Lime green color; clean lime fragrance; USDA A6.
30010183 14423 1 qt. 12/cs.



I. SCRUB FREE® MILDEW STAIN REMOVER W/BLEACH **CHURCH & DWIGHT**
 Cleans, deodorizes and bleaches tough mildew stains. Deep penetrating foaming action with no scrubbing or scratching.
A5162604 35026 32 oz. 12/cs.

TILE/DELIMER

Tile/Delimer



A. TILEX® CLOROX

Disinfects Instant Mildew Remover

Cleans, disinfects and removes mold and mildew. Cleans mildew stains without scrubbing and whitens tiles as you spray. Removes and destroys mold spores, plus Staphylococcus aureus (staph), Streptococcus pyogenes (strep) and Trichophyton mentagrophytes (Athlete's Food Fungus). Just one spray kills tough, ugly mold and mildew without scrubbing.

38381100 01100 16 oz., Trigger Sprayer 12/cs.
38385600 35600 32 oz., Refill 9/cs.
38385605 35605 1 gal. 4/cs.

Mildew Root Penetrator & Remover

Foaming action penetrates and attacks mildew at its roots, even in hard-to-clean places. Foam provides adequate contact time for deep cleaning. Patented formula suppresses bleach odor, reducing fumes and unpleasant odors.

38380263 00263 24 oz. 9/cs.

Soap Scum Remover & Disinfectant

Cleans, disinfects and removes soap scum. The powerful antibacterial formula starts cleaning soap scum on contact. Cleans and deodorizes a variety of surfaces as soon as it's applied. This disinfectant product is bactericidal and mildew static. Cleans and disinfects many surfaces, including: glazed ceramic tile, grout, fiberglass, shower doors, vinyl curtains, toilets, sinks and no-wax floors. Dissolves soap scum on contact with no scrubbing. Leaves surfaces clean and shiny. Disinfects and kills 99.9% of bathroom germs. Bleach-free.

Penetrating foam leaves surfaces gleaming.
38385604 35604 32 oz. 9/cs.



B. AJAX EXPERT® COLGATE-PALMOLIVE

Delimer/Milkstone Remover

Highly concentrated, phosphoric acid-based product. 1 qt. makes up to 8 gal. of ready-to-use solution. Effectively removes lime, calcium, magnesium, iron and oxidized aluminum from all metal and plastic surfaces.

11907130 47130 32 oz. 8/cs.

Instant Mildew Stain Remover

Powerful cleaner in a ready-to-use spray formula eliminates mold and mildew stains quickly. Foamer sprayer and a pleasant citrus fragrance make this product user friendly. USDA C1.

11904615 14615 32 oz. 8/cs.



C. CREW® TILE & GROUT REJUVENATOR DIVERSEY

Bleach-based cleaner for whitening and brightening discolored grout. Removes mold and mildew stains.

15204550 4550 32 oz., RTU 12/cs.

D. EASY PAKS® DETERGENT/DISINFECTANT DIVERSEY

Offers convenient pre-measured packaging. Cleans, disinfects, deodorizes and controls mold and mildew.

15200102 90650 (90) 1/2 oz. 180/cs.

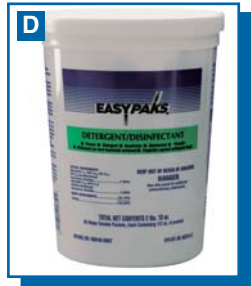

E. SUMA® DILAC® DESCALER D5.8 DIVERSEY

Acid-based limescale remover for stainless steel and some soft/plated metals. No fragrance added.

15205328 5325533 32 oz. 12/cs.

F. VANISH® TILE & GROUT CLEANER DIVERSEY

Institutional formula with special bleach ingredients that oxidize mildew stains, while detergents allow bleach to penetrate grout. Removes stains, soap scum, hard water spots.

For all washable restroom hard surfaces, including tile, tubs, sinks, stainless steel. Spray, wipe, rinse—no scrubbing. English/Spanish labeling.

15200183 90156 32 oz. 6/cs.



Tile/Delimer/Bowl Cleaners



A. COMET® CRÈME DEODORIZING CLEANSER PROCTER & GAMBLE

Liquid chlorinated cleanser containing a soft abrasive that scours and cleans stainless steel and porcelain surfaces without scratching. It clings to vertical and hard-to-reach surfaces, like toilet bowls. Effective at removing malodors from surfaces. Each bottle has a portion control, flip-seal closure.

16900870 53835 32 oz. 9/cs.



B. LIME-A-WAY® CALCIUM & RUST CLEANER RECKITT BENCKISER

Lime, calcium and rust Cleaner with Duraguard™ thick formula that coats surfaces longer for easier cleaning of tough, hard water stains. It effectively cleans the toughest hard water stains and leaves a protective coating, so that surfaces stay cleaner for longer.

58349016 39016 16 oz., Trigger Spray 12/cs.
58349605 39605 28 oz., Toggle Top 9/cs.



C. LYSOL® RECKITT BENCKISER

Basin, Tub & Tile Cleaner

Removes soap scum and dirt. Foaming action. Cleans, shines and disinfects washable bathroom surfaces and fixtures.

58347660 77660 32 oz., Green Apple 12/cs.

Disinfectant Mildew Remover w/Bleach

Fast-acting sanitizer. Whitens and removes mold and mildew stains. Removes soap scum. Removes tough spots and stains. Non-abrasive formula. Will not harm plumbing and septic systems.

58340024 78915 32 oz. 12/cs.



D. PROFESSIONAL LYSOL® RECKITT BENCKISER

Kills 99.9% of germs on hard, non-porous surfaces in 30 seconds. Removes soap scum, lime scale and hard water stains on restroom fixtures. Formula is tuberculocidal, virucidal, fungicidal and bactericidal. Contains no abrasives or bleach. Cleans, shines, disinfects and deodorizes. Prevents growth of damaging mold and mildew. Light citric acid formula. NSF Category Code C2, Reg. No. 129341.

58344685 04685 32 oz., Trigger Sprayer 12/cs.



E. SIMPLE GREEN® LIME SCALE REMOVER SIMPLE GREEN

Strong enough to dissolve soap scum, hard water stains and mineral deposits, but mild enough to protect surfaces from damage that harsher cleaners can cause. Will not harm finishes, drains or pipes (including PVC). Wintergreen scent. Ready-to-use.

73430032 50032 32 oz., Trigger Sprayer 12/cs.
73430033 50128 1 gal. 6/cs.



F. CLINGING SHOWER & TILE CLEANER ZEP

Ready-to-use bathroom shower, tile and grout cleaner. Safe for use on most hard surfaces without dilution. Contains a powerful combination of effective surfactants and chlorine. Easily removes soap scum, hard water deposits and most stubborn mold and mildew stains from tile and grout. Thickened formulation to enhance performance on walls and vertical surfaces.

75070007 R00401 1 qt. 12/cs.



G. PRIME SOURCE® BOWL SHEEN PRIME SOURCE®

Disinfectant cleaner that removes rust, calcium deposits and organic stains. 9.4% HCL disinfectant formula. EPA registered. *Check with us regarding availability/product registration status in your state.

75004037 75004037 32 oz. 12/cs.

BOWL CLEANERS

Bowl Cleaners



A. PRIME SOURCE® KLEAN BOWL EMULSION BOWL CLEANER PRIME SOURCE®

Cleans, de-scales and deodorizes toilet bowls and urinals quickly, thoroughly and with minimum effort.

76008532 76008532 946 mL 12/cs.
75004040 75004040 32 oz. 12/cs.



B. PRIME SOURCE® LUSTER BOWL & BATHROOM CLEANER PRIME SOURCE®

Non-acid disinfectant cleaner that is thickened to cling to vertical surfaces. Kills HIV-1 (AIDS virus), TB, MRSA, VRSA and VRE. EPA registered.

76008535 76008535 946 mL 12/cs.
75004036 75004036 32 oz. 12/cs.



C. PORCELAIN & BOWL CLEANER CARROLL

9.6% HCl formula, hospital use disinfectant bowl cleaner. Removes scale and hard water deposits as it disinfects. Detergent system removes resistant stains. Fresh deodorizing mint fragrance.

30016223 76223 1 qt. 12/cs.

D. PRETTY POTTY® DISINFECTANT BOWL CLEANER CARROLL

20.3% HCl formula, hospital use bowl cleaner. Removes mineral deposits, lime scale and rust. Excellent in hard water/well water locales. Clear amber color changes to blue in use; mint fragrance.

30016323 76323 1 qt. 12/cs.



E. SHOWER PATROL® RESTROOM CLEANER CARROLL

Phosphoric. Clinging formula for bath and bowl. Superior cleaner, easily removes hard water deposits. Can be diluted for tiled walls. Foaming action. Pleasant mint fragrance.

30019323 39323 1 qt. 12/cs.

F. CRYSTAL BLUE AUTOMATIC BOWL CLEANER CCP

Cleans, deodorizes, and freshens. Biodegradable. No phosphates. Tints water blue for freshly maintained appearance.

27600222 P222 9 oz., Blue 12/cs.



G. SNO BOL® TOILET BOWL CLEANER CHURCH & DWIGHT

Disinfects, cleans, and deodorizes. Removes stubborn rust and hard water stains. Leaves a fresh clean scent.

A5163000 84130 32 oz. 12/cs.

H. CLOROX® CLOROX

Automatic Bowl Cleaner

Deodorizes and keeps bowl fresh and clean for up to four months.

38381261 00946 3 1/2 oz. 6/cs.

Toilet Bowl Cleaner

Cleans, disinfects and deodorizes toilets in gel form. Removes stains and whitens with the power of Clorox® Bleach. Packs the same sanitary punch as our other cleaning agents, so stains and odors don't stand a chance. Gel formula coats the bowl for deep clean. Eliminates odor-causing bacteria. Thick gel clings to bowl. Bottle shape helps get to the tough under-bowl stains.

38389031 00031 24 oz., RTU, Fresh Scent 12/cs.

ToiletWand™ System

The Clorox ToiletWand is an all-in-one system that is designed to clean better than traditional brushes. Features disposable swivel heads loaded with Clorox cleaner. Just click, swish and toss the head away. Comes with designer storage caddy.

38383191 03191 (1) Wand & (6) Refill Heads 6/cs.

38384882 14882 (6) Refill Heads Only 48/cs.



Bowl Cleaners



A. GREEN WORKS® NATURALLY DERIVED TOILET BOWL CLEANER CLOROX

Powerful gel formula cuts through rust, hard water and even stubborn mineral deposits. 99% naturally derived and safe for septic systems. Contains no bleach or phosphorus and is made with plant and mineral-based ingredients. Angled spout makes cleaning under the rim easy.

38380451 00451 24 oz. 12/cs.



B. AJAX® EPA DISINFECTANT BOWL CLEANER COLGATE-PALMOLIVE

Ready-to-use one-step cleaning, disinfecting and deodorizing. Effective soil removal. Eliminates rust, lime and uric acid deposits. EPA Registration No. 8155-6-4582.

11904602 04601 32 oz. 12/cs.



C. SOFT SCRUB® TOTAL™ BATH & BOWL DIAL

Replace your arsenal of cleaning products with the one product that is powerful enough to clean and deodorize an entire bathroom. The patented trigger allows you to easily switch from a fine mist to a thick foam and even sprays upside down. The unique angle-neck bottle helps you get into those hard to reach places like the inside of the toilet bowl.

12800081 00375 25 1/2 oz. 9/cs.



D. CREW® DIVERSEY

Clinging Disinfectant Toilet Bowl Cleaner

Clings to vertical surfaces. Cleans, disinfects and deodorizes. Effectively removes build-ups of rust, stains, lime scale, hard water deposits, uric acid salts and other minerals. EPA registered.

15200010 4578 32 oz., 9.25% HCl Formula, RTU 12/cs.

Non-Acid Bowl Cleaner

Non-acid bowl cleaner for daily use in toilet bowls and on all washable restroom surfaces. Appealing Fresh™ fragrance. EPA registered, DIN and PCPA registered.

15204996 4996 32 oz., RTU 12/cs.



E. EASY PAKS® TOILET BOWL CLEANER DIVERSEY

Specially-formulated enzyme/detergent blend quickly dissolves in water to attack organic waste and urinary salts without harsh acids or caustics. Will not harm plumbing. Pleasant scent. NSF C1 Registered.

15200103 90652 (90) 1/2 oz. Packets 1/ea.



F. VANISH® DIVERSEY

Non-Acid Bowl & Bathroom Cleaner II

Cleans and disinfects in one step. Powerful quaternary detergent thickened liquid for toilet bowls, urinals and general purpose bathroom cleaning and disinfecting. Bactericidal, virucidal, odor neutralizer and deodorizer. Disinfects against the following organisms on hard, nonporous environmental surfaces: Staphylococcus aureus, Pseudomonas aeruginosa, Salmonella enterica. Hospital-grade. Evaluated and found to be effective in the presence of 10% serum against the AIDS virus on inanimate surfaces with one minute contact time.

15200148 90158 32 oz., RTU 6/cs.

Thick Liquid Disinfectant Bowl Cleaner

Disinfects in one minute. 9.25% hydrochloric acid formula is extra thick to cling to the sides of the bowl. Cleans, disinfects and deodorizes toilet bowls and urinals. Dissolves limescale and uric acid deposits and stains. One-step, hospital-grade cleaner/disinfectant. Kills Staphylococcus aureus, Salmonella choleraesuis, Pseudomonas aeruginosa, E. coli 0157:H7, Methicillin Resistant Staphylococcus aureus (MRSA), HIV-1 (AIDS virus), Hepatitis A Virus, Herpes Simplex 1 and 2.

15200238 90157 32 oz. 12/cs.

Bowl Cleaners/Drain Maintainers



A. CLING™ 2 IN 1 CLIP-ON TOILET BOWL DEODORIZER & CLEANER RECKITT BENCKISER

Continuous fragrancing gel plus powerful cleaning block. Powerful cleaning with every flush.
 58347136 77136 1³/₁₁ oz., Citrus & Tangerine 12/cs.
 58340004 77137 1³/₁₁ oz., Spring Waterfall 12/cs.



B. LYSOL® Deep Reach Toilet Bowl Cleaner RECKITT BENCKISER

Kills 99.9% of germs in the bowl and the mouth trap when used as directed. Thick formula coats the entire bowl. Removes lime scale through the 'S' bend. Use regularly to prevent build-up of mineral deposits.
 58348008 80088 24 oz. 12/cs.

Toilet Bowl Cleaner w/Bleach
 Cleans, disinfects and deodorizes toilets. Powerful bleach formula brightens and removes stains. Thick formula clings to the bowl to dissolve tough rust stains and mineral deposits on contact. Kills germs including salmonella and E coli. Won't harm septic systems.
 58347505 75055 24 oz. 12/cs.



C. PROFESSIONAL LYSOL® DISINFECTANT TOILET BOWL CLEANER RECKITT BENCKISER

Kills Staph, Pseudomonas, E. coli, HIV-1 (AIDS Virus) and other harmful germs on hard, nonporous surfaces. The thick acid formula coats, cleans, disinfects and deodorizes the entire bowl by dissolving stubborn stains on contact. The angle-neck bottle targets hard to reach areas. Formula will not harm plumbing or septic systems. Use in toilets and urinals.
 58344278 74278 32 oz. 12/cs.



D. VANI-SOL® HIGH ACID BOWL CLEANSER RECKITT BENCKISER

A powerful liquid toilet bowl cleaner and deodorizer. For use in restrooms with heavy traffic, hard water, or difficult soils. Powerful 23% hydrochloric acid formula. Dissolves even the toughest stains, including built-up lime deposits, hard water scale, and rust stains. Will not harm septic tanks. Contains a metal corrosion inhibitor. Angle neck for easier application.
 58342212 02212 32 oz. 12/cs.



E. NON-ACID DEODORIZER & TOILET BOWL CLEANER ZEP

Environmentally preferred, non-acidic cleaner and deodorizer, removes scale, stains, and scum. Use on toilet bowls, tiles, sinks, showers, and bathroom fixtures.
 75070006 R00301 1 qt. 12/cs.



DRAIN MAINTAINERS

F. PREMIUM PLUS ULTRA DRAIN CLEANER PRIME SOURCE®

For use in drains, grease traps and collection systems. Safely digests fat, grease, oil, protein and starch.
 75004588 75004588 5 gal. 1/ea.



G. PRIME SOURCE® PIPE DREAM BIOENZYMATIC DEODORIZER/SPOTTER/DIGESTER PRIME SOURCE®

Organically removes spots from carpet and fabrics. Multi-purpose; blended with multiple, non-pathogenic bacterial strains.
 75004070 75004070 1 gal. 4/cs.
 75004071 75004071 5 gal. 1/ea.



H. ALKA-LION® DRAIN OPENER MAINTAINER CARROLL

Unclog drains and pipes with this professional strength alkaline concentrate. This product was designed to unclog drains in foodservice and other high volume operations. It is fast-acting and effective in removing alkaline sensitive blockages. Use this powerful product with care. Do not allow aluminum contact.
 30010320 39123 1 qt. 12/cs.

Drain Maintainers



A. ENZYME DRAIN OPENER CARROLL

Special blend of enzyme producing bacteria; no harsh chemicals. Safely and effectively digest fat, grease, oil, protein, and starch. Excellent for institutional and municipal drains, grease traps, and collection systems. Pleasant fragrance.

30010458 26923 1 qt. 12/cs.



B. LIQUID-PLUMR® CLOROX

Drain Opener

Professional Strength Liquid-Plumr® clears completely clogged drains by delivering more active ingredients to the clog than other drain openers.

38380242 00242 1 qt. 9/cs.

Heavy-Duty Gel Clog Remover

A fast-acting drainage solution. Provides a powerful, fast-acting solution for drainage issues in busy workplaces, where time is money. Heavy-duty formula works on a variety of clogs. Ready-to-use, one-step solution. Safe on pipes, disposals, septic tanks and plastic pipes.

38385286 35286 80 oz. 6/cs.



C. DRANO® DIVERSEY

Liquid Clog Remover

Contains a special ingredient to protect pipes from corrosion. Safe for plastic, PVC, metal pipes, garbage disposal and septic systems. Won't harm pipes even when used overnight. Does not contain phosphorous. Starts working to break down clogs on contact. After 15 to 30 minutes, clogs are substantially minimized or dissolved. A final blast of hot water flushes away what's left of the clog.

15201169 CB000169 32 oz. 12/cs.

Professional Strength Drain Cleaner

Specially formulated to pour through standing water, powerful Drano® products won't harm plastic pipes, disposals or septic tanks. Institutional formula is a 32% caustic formula that attacks tough, grease-based clogs. Ready-to-use.

15200147 90485 32 oz. 12/cs.



D. SUMA® ELIMINEX® FOAMING DRAIN MAINTAINER DIVERSEY

Chlorinated, high-alkaline cleaner utilizes a clinging foam technology that delivers superior drain cleaning. Safe for use on soft metals such as brass, aluminum, galvanized metals or garbage disposal units. Pale yellow in color with a chlorine scent. NSF L1 Registered

15200548 4622333 5 L, RTD® 1/ea.

15200549 4624072 64 oz., Empty Bottles 4/cs.



E. RID-X® SEPTIC SYSTEM TREATMENT RECKITT BENCKISER

Helps prevent septic back-up. Contains millions of 100% natural active bacteria and enzymes that break down solid organic waste like grease, fat, protein, starch and paper. Use once per month to help keep septic systems operating smoothly. Safe for all pipes.

58340306 80306 10¹/₈ oz., 1 Dose 12/cs.

58340307 80307 20¹/₈ oz., 2 Dose 6/cs.



F. ALKALINE DRAIN OPENER ZEP

Concentrated, ready-to-use alkaline drain opener. Ideal for both corrective and preventive maintenance. Suitable for use in kitchen, bathrooms and commercial drains.

75070037 R02701 1 qt. 12/cs.



G. BIOLOGICAL DRAIN MAINTAINER ZEP

Environmentally preferred drain maintenance product powered by enzymatic activity. Safe for use in septic systems to keep drains free flowing. A biological solution for safe, routine maintenance.

75070036 R02635 5 gal. 1/ea.

Toilet & Urinal Blocks/Urinal Screens



TOILET BLOCKS

A. HEALTH GARDS® PARA TOILET BOWL BLOCK HOSPECO

Universal fit for all toilets. Blocks with deluxe hanger.

14508411 08411 4 oz., Cherry 144/cs.



B. HEALTH GARDS® TOILET RIM CAGE HOSPECO

Cleans and deodorizes toilet bowls for up to 30 days. Non-para formulation, tints water blue with each flush.

14500162 02901 Cherry 12/cs.



URINAL BLOCKS

C. HEALTH GARDS® PARA URINAL BLOCKS HOSPECO

Non-toxic biodegradable blocks.

145063115 06311 3 oz., Cherry, Corrugated Shipper 12/cs.

145064115 06411 4 oz., Cherry, Corrugated Shipper 12/cs.

14506411 06411 4 oz., Cherry, Corrugated Shipper 144/cs.



D. HEALTH GARDS® TOSS IN BLOCKS HOSPECO

Non-para toss in blocks.

14500017 04901 4 oz., Cherry 12/cs.

14500016 04905 4 oz., Citrus 12/cs.



URINAL SCREENS

E. DEOD-O-SCREEN CCP

Vinyl urinal screen has 30 days of built-in deodorant. Universal shape fits most urinals. Disposable poly-glove included. Each screen is individually packaged.

276021645 1641 Blue (Floral) 12/cs.

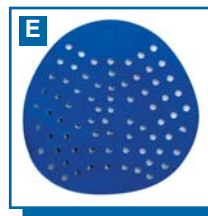

F. KLEEN-SCREEN URINAL SCREEN CCP

4 oz. enzymatic deodorant block contains surfactants and chelating agents to clean and deodorize for 30 days (up to 2,000 flushes). Coloring agents are released with each flush so you know that it's working. Increased ventilation reduces potential splash back and flexible screen traps more debris to prevent costly drain clogs.

27600793 1654 4 oz., 7¹/₈" x 7³/₄" x 1¹/₄", Red/Strawberry 12/cs.



G. CREW® DEODORANT URINAL SCREEN DIVERSEY

Very pleasant Fresh fragrance matches fragrance from most other Crew products.

15204728 14728 1500 Flushes 12/cs.



H. CHLOROSCENT™ URINAL SCREEN HOSPECO

Screen with bleach block. Para should not sit in a dry urinal because it dissipates in air and non-para should not sit in standing water. Chloroscent can be used in either environment.

The bleach assists in the breakdown of uric salts, leaving the base and the throat of the urinal clean and odor-free. Lasts twice as long as para or non-para; up to 60 days.

Acceptable for use with acid bowl cleaners.

14501664 01664 60 Days 12/cs.



I. CHLOROSCREEN™ DISSOLVABLE URINAL SCREEN HOSPECO

Prevents debris from being flushed down the urinal. Increases cleanliness, eliminates odor, leaves a clean scent, and reduces maintenance time. Lasts up to 60 days. Contains no dyes to stain urinals. Naturally dispenses bleach in the water every time the urinal is flushed. Dissolves 100%. No removal is required. Individually wrapped.

14501661 01661 60 Days 24/cs.



Urinal Screens/Deodorants

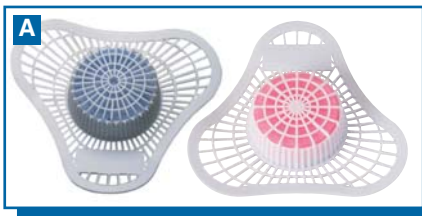

A. HEALTH GARDS® URINAL SCREENS HOSPECO

w/Non-Para Block

Clean and deodorize for up to 1,500 flushes. Non-staining, non-toxic, biodegradable block. Prevents drain clog while deodorizing. Exclusive patented no-splash design.

14500164	01901	Cherry	12/cs.
14501905	01905	Citrus	12/cs.

w/Para Block

Deodorizes for up to 30 days. Helps prevent drain clogs.

14501991	01991	4 oz., Cherry	12/cs.
----------	-------	---------------	--------



B. HEALTH GARDS® VINYL URINAL SCREENS HOSPECO

Odor control lasts for at least 30 days. Helps to eliminate odors while preventing clogging. Flexible to fit all urinals.

14503907	03907	Bubble Gum (Dark Blue)	12/cs.
14503902	03902	Cherry (Green)	12/cs.
14503901	03901	Cherry (Red)	12/cs.
14503905	03905	Citrus (White)	12/cs.
14503904	03904	Mint (Blue)	12/cs.



C. Z-SCREEN DEODORIZING URINAL SCREEN IMPACT PRODUCTS

Contains enzymes to clean urinals and eliminate odors. Unique design prevents splashback and reduces cleaning time. Flexible material conforms to urinal to trap debris. Safe for use in waterless urinals. Strong, gradual fragrance release ensures 30 day use.

14601495	1495	Fresh Blast, Smoke	72/cs.
----------	------	--------------------	--------

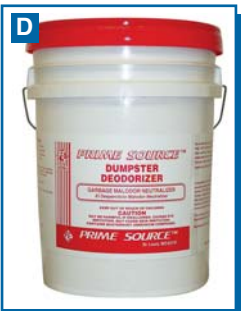

POWDER DEODORANTS

D. PRIME SOURCE® DUMPSTER DEODORIZER PRIME SOURCE®

Eliminate garbage odors at their source and keep them from returning. Dumpster Deodorizer garbage malodor neutralizer is specifically designed to eliminate odors in and around trash collection areas.

25154225	25154225	25 lb.	1/ea.
----------	----------	--------	-------

E. ARM & HAMMER® CHURCH & DWIGHT

Baking Soda

An effective yet natural and gentle cleaner with no harsh chemicals. Can be used for baking, cleaning, and deodorizing.

A5160400	84104	1 lb.	24/cs.
----------	-------	-------	--------

Fridge-N-Freezer® Baking Soda

Flo-Thru Freshener™ design for freshness and deodorization in the refrigerator or freezer. Design prevents spillage.

A5161382	84011	16 oz.	12/cs.
----------	-------	--------	--------

Trash Can & Dumpster Deodorizer

With baking soda. User friendly and environmentally sensible.

A5161600	84116	42 ² / ₃ oz.	9/cs.
----------	-------	------------------------------------	-------



WALL DEODORANTS

F. HEALTH GARDS® STICK UP DEODORANT BLOCKS HOSPECO

Stick up deodorant blocks.

14500213	05902	9 oz., Apple	12/cs.
14505905	05905	9 oz., Citrus	12/cs.



Liquid Deodorants



LIQUID DEODORANTS

A. PRIME SOURCE® DEODORANTS

PRIME SOURCE®

Economical, versatile, may be used as a space spray or in detergents.

75004116	75004116	1 gal., Lemon	4/cs.
75004115	75004115	1 gal., Cherry Blossom	4/cs.
75000040	75000040	55 gal., Cherry Blossom	1/ea.



B. HAPPY® MALODOR COUNTERACTANT

CARROLL

Chemically neutralizes odor causing molecules with no overpowering scent. Can be used on fabrics without staining or residue at proper dilution. Add to cleaning products to eliminate odors and improve cleaning. Light floral fragrance.

30010310	41723	1 qt.	12/cs.
30010311	41728	1 gal.	4/cs.



C. HEAVY-DUTY CHEMICAL DEODORANT

CARROLL

Chemically reacts with odors to eliminate them, not just cover them up. Highly concentrated, water soluble formula. Excellent for use in portable toilets, aircraft toilets, campers and boats. Dark blue; pleasant fragrance in use; USDA C1.

30010312	41828	1 gal., Dark Blue	4/cs.
----------	-------	-------------------	-------



D. GOOD SENSE® ODOR COUNTERACTANT

DIVERSEY

Ready-to-use spray odor counteractants help neutralize tobacco, mold, mildew and urine surface/airborne odors. Uses J-Lift™ technology to lift fragrance into the air.

15204437	4437	32 oz., Outdoor Fresh™	12/cs.
----------	------	------------------------	--------



E. SUMA® DUMPSTER FRESH™™

DIVERSEY

Noticeably reduces the smell of garbage. Three-part treatment offers strong cleaner, "knock down" fragrance and bioactive nonpathogenic (non-disease causing) formula that quickly goes to work creating enzymes to digest grease and other organic soils. Applied bacteria keep odors from coming back. Requires no scrubbing, just spray and walk away.

15206359	4266359	32 oz.	1/ea.
----------	---------	--------	-------



F. LIQUID ALIVE® ODOR DIGESTER

DYMON

A natural solution of enzyme producing bacteria that gives instant and residual odor control. Eliminates malodors caused by dampness, mildew, mold, waste from food, urine, fecal matter, and other organic waste. Does not stain fabrics and is biodegradable and non-toxic to animals and humans. 32 oz. pictured.

31123362	33601	1 gal.	4/cs.
----------	-------	--------	-------



G. BREAKDOWN® ENZYME ODOR ELIMINATOR

JOHNSON DIVERSEY

Contains enzymes and odor counteractants that combat the source of odors. Effective against a wide range of odors in carpets, washrooms, trash cans and more. Long-lasting pleasant fragrance.

57081115	4291110	1 gal., Fresh	4/cs.
----------	---------	---------------	-------

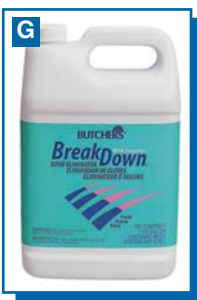

H. FEBREZE® FABRIC REFRESHER & ODOR ELIMINATOR

PROCTER & GAMBLE

Febreze cleans away odors trapped in fabrics. Proprietary cleaning system goes to the source of odors and eliminates them. Patented binding technology locks on to odor molecules and traps them for good. A light, fresh scent is left behind to leave the treated area smelling fresh and clean. Safe for virtually all fabrics.

16909756	03259	32 oz., Trigger Sprayer	8/cs.
16903032	33032	1 gal.	3/cs.
16907563	36551	1 gal., Concentrate	2/cs.



Liquid & Aerosol Deodorants



A. LYSOL® NEUTRA AIR® FABRIC MIST RECKITT BENCKISER

Eliminates bacterial odors at the source and leaves a light, fresh scent. Suitable to use on most fabrics and in the air. Kills 99.9% of bacteria on soft surfaces.

58340042 82669 27 oz., Trigger Sprayer 9/cs.



B. PROFESSIONAL AIR WICK® LIQUID DEODORIZER RECKITT BENCKISER

Freshens the air and eliminates odors. Use 1:10 to deodorize and 1:24 for economic, everyday freshening. Helps control cigarette and cigar smoke, mold and mildew, gym, drain, bathroom and cooking odors, as well as odors from incontinent areas. NSF Category Code C1: Reg. No. 129365.

58346732 06732 1 gal., Clean Breeze, Concentrate 4/cs.



C. Z-FRESH ODOR NEUTRALIZERS ZEP

Environmentally preferred, highly effective odor neutralizer. Chemically eliminates the source of odors and replaces them with a pleasant clean fragrance.

75070022 R01601 1 qt., Breeze 12/cs.

75070025 R01901 1 qt., Potpourri 12/cs.

75070026 R02001 1 qt., Subdue 12/cs.

AEROSOL DEODORANTS

D. PRIME SOURCE® DRY AIR FRESHENER AEROSOL PRIME SOURCE®

Dry air freshener and odor neutralizer. Eliminates tough odors, including tobacco.

75004101 75004101 10 oz., Cinnamon Stick 12/cs.

75004102 75004102 10 oz., Dry Breeze Bouquet 12/cs.

75004100 75004100 10 oz., Mango Magic 12/cs.

75004104 75004104 10 oz., Powder Puf 12/cs.

75004099 75004099 10 oz., Tropical Flower 12/cs.

75004098 75004098 10 oz., Vanilla Caramel 12/cs.

75004106 75004106 17 oz., Nice Air Lemon 12/cs.

75004105 75004105 17 oz., Nice Air Spice 12/cs.



E. ARM & HAMMER® DEODORIZING AIR FRESHENER CHURCH & DWIGHT

Aerosol spray with light pleasant scent.

A5167000 84170 7 oz. 12/cs.



F. GLADE® Air Fresheners DIVERSEY

Eliminates strong persistent odors with clean scent, not a heavy perfume. Use in commercial, industrial or institutional buildings. Trilingual packaging.

15200041 94780 14 oz., Country Garden® Potpourri 12/cs.

15200030 94787 14 oz., Smoke Odor Eliminator 12/cs.

15200140 94782 14 oz., Super Fresh® 12/cs.

Surface Disinfectant & Air Sanitizer

Surface disinfectant and air sanitizer with Oust® technology. Kills 99.9% of germs and viruses on hard, nonporous surfaces. Disinfects and deodorizes by killing common germs and controlling their odors. Also prevents odors at their source caused by germs, bacteria and mildew.

15205980 CB715980 12 oz., Clear Springs® 12/cs.

15205973 CB715973 12 oz., Refreshing Citrus™ 12/cs.

Tough Odor Solutions Air Sanitizer

Air sanitizer with Oust® technology. Kills odor-causing bacteria. Eliminates even the toughest pet, cooking and bathroom, mold and mildew odors while leaving a refreshing scent so your room smells fresh and clean.

15205935 CB715935 10 oz., Clear Springs® 12/cs.

15205942 CB715942 10 oz., Refreshing Citrus™ 12/cs.



Aerosol Deodorants/Deodorant Systems



A. GOOD SENSE® INSTANT AIR FRESHENERS DIVERSEY

Fast-acting, instant air freshener that leaves a pleasant scent. CFC-free.

15205325	5035325	13 ¹ / ₂ oz., No Smoke	12/cs.
15200513	5035317	13 ¹ / ₂ oz., Potpourri	12/cs.
15200478	5035288	13 ¹ / ₂ oz., Tuscan Garden	12/cs.



B. OUST® AIR SANITIZERS DIVERSEY

Snuffs out odors caused by bacteria before you smell them. Kills odor-causing bacteria in the air.

15200174	CB028684	10 oz., Citrus Scent	12/cs.
15200173	CB028653	10 oz., Outdoor Scent	12/cs.



C. FEBREZE® AIR EFFECTS AIR REFRESHERS PROCTER & GAMBLE

Formulated to actually eliminate odors in the air instead of just masking them. Clears away stale, stifling odors while leaving a fresh, clean scent behind.

16901649	45535	9 ⁷ / ₈ oz., Meadows & Rain	9/cs.
16901650	45536	9 ⁷ / ₈ oz., Spring & Renewal	9/cs.



D. AIR WICK® 2 IN 1 AEROSOL AIR FRESHENERS RECKITT BENCKISER

Helps remove tough odors and leaves a light, clean fragrance.

58347002	77002	8 oz., Fresh Waters	12/cs.
58345762	05762	8 oz., Lavender & Chamomile	12/cs.
58347895	77895	8 oz., Papaya & Mango	12/cs.



E. LYSOL® NEUTRA AIR® AIR SANITIZERS RECKITT BENCKISER

Lysol® Neutra Air® sanitizing spray destroys bacterial odors by sanitizing the air and attacking odors at their source by killing 99.9% of odor-causing bacteria.

58346940	76940	10 oz., Citrus	12/cs.
58346938	76938	10 oz., Fresh	12/cs.
58349196	79196	10 oz., Morning Dew	12/cs.



F. SMOKE & ODOR NEUTRALIZER ZEP

Highly effective aerosol odor counteractant. Safe for use on fabrics. Formulated to neutralize and eliminate smoke related odors. Leaves a pleasant fresh fragrance.

75070024	R01801	20 oz.	12/cs.
----------	--------	--------	--------

DEODORANT SYSTEMS - AEROSOL

G. PRIME SOURCE® METERED DEODORANT SPRAY DISPENSER/REFILLS PRIME SOURCE®

Dispenser

Attractive cabinet. Adjustable spray intervals. Effective control for up to 6,000 cubic feet.

75004095	75004095	6 ¹ / ₂ oz.	1/ea.
----------	----------	-----------------------------------	-------

Refills

Neutralizes and deodorizes. Up to 3,000 metered sprays per can. Effective on smoke and restroom odors.

75004111	75004111	6 ³ / ₄ oz., Apple	12/cs.
75004114	75004114	6 ³ / ₄ oz., Baby Powder	12/cs.
75004113	75004113	6 ³ / ₄ oz., Cherry Berry	12/cs.
75004108	75004108	6 ³ / ₄ oz., Cinnamon	12/cs.
75004123	75004123	6 ³ / ₄ oz., Citrus Sunburst	12/cs.
75004112	75004112	6 ³ / ₄ oz., Fresh Linen	12/cs.
75004107	75004107	6 ³ / ₄ oz., Lemon Drop	12/cs.
75004120	75004120	6 ³ / ₄ oz., Mystic Mango	12/cs.
75004121	75004121	6 ³ / ₄ oz., Ocean Mist	12/cs.
75004122	75004122	6 ³ / ₄ oz., Something Peachy	12/cs.
75004110	75004110	6 ³ / ₄ oz., Vanilla	12/cs.
75004109	75004109	6 ³ / ₄ oz., Wildflower	12/cs.
760007631	76000763	369 g, Citrus Sunburst	1/ea.
76000763	76000763	369 g, Citrus Sunburst	12/cs.



Deodorant Systems



CHEMICALS



A. KLEEN TECH™ DELUXE AIR FRESHENER DISPENSER/REFILLS

CCP

Effective in rooms up to 6,000 cu. ft. for 30 days. Key or keyless lock. "D" cell batteries not included. Deluxe features a real time clock, from 1 to 60 minute spray intervals, programmable start and stop, On/Off switch and LED refill/battery reminder. Fits most metered aerosols.

Dispenser

27600156 1190 9 1/4" x 3 1/2" x 3 1/2", White 6/cs.

Refills

27602187 1187 7 oz., Cinnamon 12/cs.

27601048 1183 7 oz., Garden Apple 12/cs.

27602186 1186 7 oz., Lemon 12/cs.

27601163 1162 7 oz., Orange 12/cs.

27601182 1182 7 oz., Nautical Mist 12/cs.



B. GOOD SENSE® AUTOMATIC SPRAY SYSTEM CARTRIDGE

DIVERSEY

A simple and efficient solution to on-going odor control needs. Patented concentrated aerosol technology delivers a dry and fine mist resulting in long-lasting action against malodors.

15204809 4809 19 mL, Fresh 12/cs.



C. HEALTH GARDS® METERED AEROSOL REFILLS

HOSPECO

Metered aerosols featuring Neutrex, the smart odor neutralizer. Formulated for public restrooms and other large rooms. Covers up to 6,000 cubic feet. Universal spray actuator fits most competitive dispensers. The 7 oz. can provides 30 days of continuous deodorization. VOC compliant.

14500062 07906 Cinnamon Spice 12/cs.

14500154 07931 Citrus Grove 12/cs.

14507909 07909 Fresh Baby Powder 12/cs.

14507932 07932 Fresh Garden 1/ea.

14507918 07918 Fresh Linen 12/cs.

14507915 07915 Very Vanilla 12/cs.



D. AIR WICK® FRESHMATIC®

AIR FRESHENER STARTER KITS

RECKITT BENCKISER

Delivers continuous room-freshening for up to 60 days. FreshMatic's subtle, time-released fragrances are set to ensure an always-pleasant, always-welcoming atmosphere. Starter kit is complete with everything you need, including the automatic unit, fragrance spray and two AA batteries.

58349782 79782 Aqua Essences™ Fresh Waters 4/cs.

58348620 78620 Papaya & Mango 4/cs.



E. AIR WICK® FRESHMATIC®

AIR FRESHENER REFILLS

RECKITT BENCKISER

Delivers continuous room-freshening for up to 60 days. Fits Freshmatic® Ultra and Freshmatic® Ultra i-Motion™.

58342314 82314 Cool Linen & White Lilac 6/cs.

58349553 79553 Fresh Waters 6/cs.

58340028 78283 Harvest Spice® 6/cs.

58347961 77961 Lavender 6/cs.

58348621 78621 Papaya & Mango 6/cs.

58347965 77965 Sparkling Citrus® 6/cs.

58340030 80978 Vanilla Indulgence 6/cs.

Deodorant Systems



A. AIR WICK® FRESHMATIC® COMPACT I-MOTION™ AIR FRESHENER RECKITT BENCKISER

Easy and convenient, features three time settings: set to spray every 7½, 15, or 30 minutes. Battery-powered timer-switch. X-Press® button for an extra boost of fragrance as needed. Great for any size room. Lasts up to 60 days (on 30 minute setting). Kit contains: automatic unit, fragrance spray and three batteries. Refills are 0.8 ounces.

58349902	79902	Aqua Essences™ Fresh Waters, Starter Kit	6/cs.
58349904	79904	Aqua Essences™ Fresh Waters, Refill Only	10/cs.
58349907	79907	Lavender & Chamomile, Refill Only	10/cs.



B. AIR WICK® FRESHMATIC® ULTRA AIR FRESHENER KIT RECKITT BENCKISER

Delivers continuous room-freshening for up to 60 days. FreshMatic®'s subtle, time-released fragrances are set to ensure an always-pleasant, always-welcoming atmosphere. Starter kit is complete with everything you need, including the automatic unit, fragrance spray and two AA batteries.

58347960	77960	Lavender	4/cs.
-----------------	-------	----------	-------



C. LYSOL® NEUTRA AIR® FRESHMATIC KIT W/BOOST TECHNOLOGY® RECKITT BENCKISER

Neutralizes tough odors in the air from odor-causing bacteria including smoke, bathroom, pet and mildew odors. Refreshes the air, leaving a clean, pleasant fragrance. Three time settings - 9, 18 or 36 minutes. Keeps your bathroom, kitchen or any room smelling fresh and clean. Refill is 6⅛ oz. and lasts for up to 60 days. X-Press® Boost Button delivers an extra boost of freshness.

58349830	79830	Fresh Scent, Starter Kit	4/cs.
58349831	79831	Fresh Scent, Refill Only	6/cs.
58348088	80881	Lemon Essence, Refill Only	6/cs.



D. SEBREEZE® AEROSOL ODOR CONTROL UNIT/REFILLS RUBBERMAID

Dispenser

Easy to operate with no programming required. Accommodates 3000 and 9000 Series fragrance canisters. Keyless locking cabinet. Consistently metered sprays every 15 minutes.

17705137	5137	Off White	6/cs.
-----------------	------	-----------	-------

9000 Series Refills

Effective odor control for continuous customer satisfaction. Proprietary odor neutralizing technology for odor elimination. Customer preferred, clean, fresh fragrances. Meets State of California less than 30% VOC requirements. Effective coverage of up to 6,000 cubic feet.

Fits #5137 and #5169 units.

17705139	5139	Citrus Breeze	12/cs.
17705138	5138	Spring Garden	12/cs.



E. MICRO TIMEMIST® PROGRAMMABLE METERED DISPENSER/REFILLS WATERBURY

Dispenser

Simple programming with 15, 30, and 45 spray settings. Automatic air freshening and odor control up to 45 days with ultra-concentrated refills. A sophisticated metered air freshening system made especially for small washrooms. Two C-cell alkaline batteries are needed to operate the unit.

72221041	321041TM1	White/Gray	6/cs.
-----------------	-----------	------------	-------

3000 Shot Refills

Provides 30 days of continuous use when set at 15 minute intervals. Fragrance and odor counteractants in one can. Level 1 aerosol, safe for storage areas. For use in all TimeMist® Micro Plus dispensers. Cans are 3 ounces.

72220058	336308TMCA	Citrus	12/cs.
72226302	336302TMCA	Clean'N Fresh	12/cs.
72220059	336360TMCA	Mango	12/cs.



Deodorant Systems



A. TIMEMIST® CLASSIC METERED AIR FRESHENER DISPENSER/REFILLS WATERBURY

Dispenser

A simple and reliable automatic metered dispenser. Provides maximum odor control at a minimum cost. Basic on/off control. 15 minute spray setting. 30-day refill life. Operates on two C batteries.

72220047 321111TM Gray 1/ea.

Premium Refills

TimeMist® premium metered air fresheners contain odor counteractants to eliminate offensive odors. For use in all full-size TimeMist® metered dispensers. Fragrance and odor counteractants in one can. Fragrances contain essential oils to ensure they are the longest-lasting and highest-quality fragrances on the market. Refills last a full 30 days.

72222517	332517TMCA	Cherry	12/cs.
72222571	332508TMCA	Citrus	12/cs.
72222502	332502TMCA	Clean'N Fresh	12/cs.
72220004	334709TMCA	French Kiss	12/cs.
72222960	332960TMCA	Mango	12/cs.
72222573	332553TMCA	Spring Flowers	12/cs.
72222965	332965TMCA	Voodoo Berry	12/cs.



B. Z-MIST ODOR COUNTERACTANTS ZEP

Highly-concentrated, metered odor counteractant. Treats up to 6,000 cubic feet of closed air space with 3,000 sprays per can providing approximately 30 days coverage. Designed for use with the Zep Professional Z-Mist dispenser.

75070021	R01501	6 1/2 oz., Clean Air	12/cs.
75070023	R01701	6 1/2 oz., Fresh Cinnamon	12/cs.
75070019	R01301	6 1/2 oz., Fresh Green Apple	12/cs.



DEODORANT SYSTEMS - GEL/SOLID



C. KLEEN AIRE WICK AIR FRESHENERS CCP

A long-lasting economical way to control odors. Designed to freshen 1,500 cubic feet for 45 to 60 days. Non-spill 1 1/2 oz. bottle with adjustable wick is VOC compliant. Mini cabinet houses freshener and provides a professional appearance. One cabinet provided with each dozen fresheners.

27600153	153	1 1/2 oz., Cherry	72/cs.
27601154	154	1 1/2 oz., Lemon	72/cs.



D. RENUZIT® ADJUSTABLES LONG LAST AIR FRESHENER DIAL

Renuzit® Adjustables are easy-to-use. Simply adjust the cone height to release the right amount of fragrance to banish odors and leave behind a clean, refreshing scent. Renuzit® Adjustables come in many exceptional fragrances that will transform any room - Freshness For Pennies a Day®. It's an affordable way to give any room a refreshing new scent.

12803659	03659	7 1/2 oz., Super Odor Killer®	12/cs.
-----------------	-------	-------------------------------	--------

E. RENUZIT® PEARL SCENTS™ AIR FRESHENING PEARLS DIAL

A continuous action air freshener that lasts up to 30 days. Simple and easy-to-use product that is attractive and eliminates tough odors wherever its needed.

12800080	36065	Pure Breeze®	8/cs.
-----------------	-------	--------------	-------



F. GLADE PLUGINS® SCENTED GEL REFILLS DIVERSEY

Long-lasting, refillable air fresheners that plug into any 110 volt electric outlet. Use only as much current as a night light to freshen air for up to 45 days.

15204923	CB006965	3 Pack, Tropical Mist	36/cs.
-----------------	----------	-----------------------	--------

Deodorant Systems



A. SCOTT® CONTINUOUS AIR FRESHENER SYSTEM KIMBERLY-CLARK

The sensible way to keep your restrooms smelling fresh. There are no batteries to replace, it's completely self-powered, and it provides continuous air freshening in your restroom 24 hours a day, 7 days a week. Each cartridge lasts for 60 days. Dispenser is easy-to-use and, unlike other air freshening systems, does not require programming.

15401067	91067	Citrus, Refill	6/cs.
15400072	91072	Ocean, Refill	6/cs.



B. AIR WICK® X-PRESS™ SCENTED OIL WARMER RECKITT BENCKISER

Continuous fragrance all day. Fan circulates additional fragrance when X-Press™ button is pushed. Five continuous fragrance settings. Fits all current Air Wick scented oil refills.

58348664	78664	1 Unit	6/cs.
----------	-------	--------	-------



C. AIR WICK® DECOSPHERE™ AIR FRESHENERS RECKITT BENCKISER

Fresh fragrance lasts for six weeks. Air freshener with a modern look. Strength of fragrance is easily adjustable. Glass container.

58347340	77340	2½ oz., Magnolia & Cherry Blossom	6/cs.
58346755	76755	2½ oz., Papaya & Mango	6/cs.



D. SEBREEZE® AUTOMATIC ODOR CONTROL UNIT/CASSETTES RUBBERMAID

Unit

Long-lasting effective odor control. Use as a wall-mounted or free standing unit. Delivers 24 hour odor control for a full 30 days. Air flow vents and battery operated fan disperse fragrance continuously.

177051151	5114	7¾"H x 3⅝"L x 3½"W, Off White	1/ea.
17705115	5114	7¾"H x 3⅝"L x 3½"W, Off White	6/cs.

Cassettes

Gel absorbs odors in the air and converts them to non-toxic, odorless compounds. Includes battery for easy, one step replacement. 24 hour odor control for a full 30 days.

17700207	9C84	Citrus Breeze	6/cs.
17700209	9C83	Fresh Apple	6/cs.
17709060	9C87	Lavender Bouquet	6/cs.



E. SEBREEZE® PORTABLE ODOR CONTROL UNIT RUBBERMAID

Ideal for small, confined areas. Use as a wall-mounted or free standing unit. 24 hour odor control for a full 30 days. Air flow vents and battery operated fan disperse fragrance continuously for complete room coverage.

177002021	9C90	3½"L x 2⅝"W x 5½"H	1/ea.
-----------	------	--------------------	-------

Cassette

17709015	5119	Jungle Rain (Floral)	6/cs.
----------	------	----------------------	-------



F. TIMEWICK BY TIMEMIST® AIR FRESHENER DISPENSER/REFILLS WATERBURY

Dispenser

Delivers 60 consistent days of premium air freshening, utilizing state of the art sintered polymer wick technology. The TimeWick system yields linear dispersion of essential oils, achieving optimum fragrance distribution with no power source. Small dispenser and refill for discreet fragrancing. Attractive design. Easy-to-use. Tamper resistant. Highly cost effective. Coverage: 3000 cubic feet.

72220952	326100XX	Non-Metered Dispenser, White, Generic	6/cs.
----------	----------	---------------------------------------	-------

Refills

72226108	676108TM	Citrus Twist	6/cs.
72220072	676110TM	Cucumber Melon	6/cs.
72226109	676109TM	Floral Fantasy	6/cs.
72226160	676160TM	Mango Smoothie	6/cs.
72226112	676111TM	Sundried Linen	6/cs.
72226115	676115TM	Xtreme Citrus	6/cs.



Chemical Systems/Insecticides

CHEMICAL SYSTEMS



A. RTD® CHEMICAL CONCENTRATES DIVERSEY

No service requirement increases productivity with no down time. No equipment to buy, so you can have more dispensers in your facility, increasing efficiency by decreasing trips to the supply closet. Requires virtually no training. Use right out of the box, no product or metering devices to connect. Easy to understand control knob uses simple icons to indicate different positions. Operating instructions enclosed in each case. Super-concentrated products deliver more gallons of RTU products than conventional packaging. Pre-installed metering ensures accuracy and eliminates over-use. Different fill rates, high flow for efficiency, low flow for low foam. Compact design makes transporting convenient and can be wall mounted with optional kits. The dispenser is a permanent part of the package, ensuring proper connection and no exposure to concentrate. No contact with concentrate increases worker safety. Specially designed handle promotes proper use while decreasing chance of error while operating.

15201057	<i>3481057</i>	1.5 L, Fantastik® All Purpose Cleaner	1/ea.
15201049	<i>3481049</i>	1.5 L, Windex® Glass Cleaner	1/ea.
15209563	<i>3719563</i>	1.5 L, Scrubbing Bubbles® Bathroom Cleaner	1/ea.

B. RTD® HOOK-UP KIT DIVERSEY

RTD® products require a one-time purchase of a water hook-up kit to operate the system. Each water hook-up kit is bagged complete with bar code for easy individual resale to the end-user.

15201746	<i>3191746</i>		12/cs.
-----------------	----------------	--	--------

INSECTICIDES

C. RAID® DIVERSEY

Ant & Roach Killer

Raid ant and roach killer contains quick-killing pyrethrum for rapid kill action. It keeps killing up to four weeks.

15204400	<i>CB216135</i>	17½ oz., Outdoor Fresh	12/cs.
-----------------	-----------------	------------------------	--------

Commercial Flying Insect Killer

Clears an entire room in minutes, fast knockdown of flies, mosquitoes, small flying moths and gnats. Use in restrooms, non-food handling areas of kitchens and garbage collection areas. Formula designed specifically for commercial and industrial insect control.

15200160	<i>94892</i>	19 oz.	6/cs.
-----------------	--------------	--------	-------

Concentrated Deep Reach™ Fogger

Kills a broad range of insects. Designed for serious insect problems. Keeps killing for up to two months. Penetrates into cracks, crevices and carpet fibers to seek out and kill bugs where they live, breed and hide to relieve heavy infestations. Non-staining; won't leave a wet, messy residue.

15204797	<i>CB815901</i>	1½ oz., 3 Pack	36/cs.
-----------------	-----------------	----------------	--------

Wasp & Hornet Killer

Kills paper wasps, yellow jackets, mud daubers and bald-faced hornets in seconds on contact. Sprays up to 22 feet. Allows you to kill from a distance. Dielectric breakdown voltage of 32,500 volts.

15209489	<i>CB013536</i>	14 oz.	12/cs.
-----------------	-----------------	--------	--------

D. SKIDOO® INSTITUTIONAL FLYING INSECT KILLER DIVERSEY

Kills houseflies, flying moths and gnats. Approved for use in and around food handling establishments. Active ingredients: Pyrethrins and Piperonyl butoxide.

15203286	<i>4203286</i>	16 oz.	6/cs.
-----------------	----------------	--------	-------

Insecticides/Insect Repellents



A. COBRA™ INSECT CONTROL SYSTEM DIVERSEY

Fast, safe and effective 24-hour fly control for food handling areas. Attracts insects with 3–15 watt UVA bulbs. Translucent cover increases UV emission and greatly improves catch. Captures insects on removable adhesive trapping boards, keeping them out of sight and intact. Operates silently—no zap or sizzle. Low voltage allows strategic placements. Easy maintenance of replacement bulbs and adhesive boards. Meets all FDA and USDA requirements for use in and around food handling facilities when used as directed.

15203567	4193567	22 ³ / ₅ " x 16 ⁴ / ₅ " x 7 ¹ / ₅ ", 45W Insect Light Trap	1/ea.
15203583	4193583	15 ct., Replacement Universal Adhesive Boards	15/cs.
15203591	4193591	Replacement Tubes Only (Sleeved)	2/cs.
15203575	4193575	Replacement Tubes Only (Standard)	2/cs.



B. VECTOR® DISCREET FLY SYSTEM DIVERSEY

A stylish insect light trap which uses high efficiency, compact tubing offering the same light output as traditional fluorescent lamps. Unobtrusive; its attractive design allows for placement in public areas where fly control needs to be less obvious. Meets all FDA and USDA requirements for use in and around food handling facilities when used as directed.

15200078	95363	Each, 110V/60 Hz	1/ea.
15205364	95364	Each, Replacement Bulb, 15W	1/ea.
15200079	95365	24 Sets, Replacement Boards	24/cs.



C. ANT & ROACH SPRAY ZEP

Water-based crack and crevice spray for crawling insects. Non-staining formula may be applied to baseboards, windowsills and behind sinks. Also kills ticks, crickets, silverfish, cover mites, centipedes, fire ants and spiders.

75070090	R06001	24 oz.	12/cs.
-----------------	--------	--------	--------



D. FLYING INSECT KILLER ZEP

Versatile insecticide for space spraying and surface applications. Also effective against flying and crawling insects. Safe for use in food handling areas. Suitable for indoor and outdoor use. Natural pyrethrin formulation. Pleasantly fragranced.

75070091	R06101	24 oz.	12/cs.
-----------------	--------	--------	--------



E. WASP & HORNET SPRAY ZEP

Long-reaching knockdown spray (up to 22'). Immediately kills on contact. Non-conductive up to 47,300V. Controls bees, wasps, hornets and yellow jackets. Safe for use around power lines. High pressure spray to reach difficult areas.

75070087	R05701	20 oz.	12/cs.
-----------------	--------	--------	--------



INSECT REPELLENTS

F. OFF!® DIVERSEY

FamilyCare Spray

7% DEET formula. Spray repels mosquitoes, chiggers, ticks and other biting insects for up to two hours. Specially-formulated with a lower level of active ingredient and aloe vera to feel and smell better on your skin.

15204912	CB018357	6 oz. Aerosol, Unscented	12/cs.
-----------------	----------	--------------------------	--------

Active® Insect Repellent

15% DEET formula. Sweat resistant OFF! Active® repellent protects against mosquitoes that may be carrying the West Nile virus, biting flies, gnats, ticks, no-see-ums and a variety of other biting insects.

15201810	CB018104	6 oz. Aerosol, Fresh Scent	12/cs.
-----------------	----------	----------------------------	--------

Deep Woods

25% DEET formula. Provides up to eight hours protection from mosquitoes. Non-greasy and resists perspiration. Repellents provide long-lasting repellency against ticks, mosquitoes, black flies, sand flies, chiggers, fleas, gnats and no-see-ums.

15200146	CB018425	6 oz. Aerosol	12/cs.
-----------------	----------	---------------	--------



Rodent Control/Lubricants



CHEMICALS



RODENT CONTROL

A. D-CON® BAIT RECKITT BENCKISER

Rat & Mouse Killer Pellets

Large "rat sized" pieces. Single feed formula. Contains four ready-to-use bait trays. Kills warfarin-resistant rats.

58340054 00252 12 oz. 12/cs.

Mouse-Prufe II

Single feed formula. Easy-to-use wedge. Kills warfarin-resistant mice.

58340051 00051 1½ oz. Box 24/cs.

58340948 00948 1½ oz. Box, 4 ct. Multipack 60/cs.

Rat & Mouse Bait Block

Easy-to-use blocks. Less messy than regular bait pellets. Moisture-resistant for use in damp environments and humid climates.

58346443 76443 96/cs.

Ready Mixed Rat & Mouse Killer

Single feed formula. Ready-to-use bait trays. Kills warfarin-resistant mice and rats.

58340053 00202 12 oz., 4 Pack Trays 12/cs.

B. D-CON® MOUSE TRAPS RECKITT BENCKISER

Wood Mouse Trap

Quick action mechanism. Easy-to-use. Twin pack trap packages.

58340105 00105 72/cs.

Covered Mouse Trap

Reusable trap with no rodent contact. Catches mice not fingers. Easy disposal.

58340027 00027 36/cs.

LUBRICANTS

C. PRIME SOURCE® MINERAL OIL LUBRICANT PRIME SOURCE®

White, food-grade mineral oil is odorless. Easily lubricates trolleys, meat hooks and other equipment in meat and food service industries.

75004008 75004008 32 oz. 12/cs.

D. PRIME SOURCE® PENETRATING OIL AEROSOL PRIME SOURCE®

Penetrating oil provides a protective film to reduce and resist corrosion. Non-flammable oil can loosen nuts and bolts quickly.

75004089 75004089 18 oz. 12/cs.

E. PRIME SOURCE® SILICONE RELEASE AEROSOL PRIME SOURCE®

Silicone release agent and lubricant prevents sticking, squeaking and binding on food processing equipment. Silicone is safe for use around food. Colorless, non-flammable, non-staining and water-resistant.

75004080 75004080 20 oz. 12/cs.

F. PRIME SOURCE® WHITE LITHIUM GREASE AEROSOL PRIME SOURCE®

Will not freeze, melt or wash away. Resists corrosion and provides superior lubrication on all metal applications.

75004090 75004090 10¼ oz. 12/cs.

G. Z-WORKS ZEP

Aerosol PTFE Lubricant

Premium, long-lasting lubricant. PTFE formulation penetrates rapidly to loosen parts frozen due to wear, corrosion, and grime buildup leaving behind a friction reducing film.

75070102 R07001 20 oz. 12/cs.

Rapid Penetrant

Multi-purpose, fast-acting aerosol penetrant and lubricant that effectively displaces water. Applies to surface as yellow foam to ensure even application and adequate contact time. Silicone formulation prevents corrosion.

75070104 R07201 24 oz. 12/cs.

Automotive & HVAC Cleaners



AUTOMOTIVE CLEANERS

A. WASH & WAX VEHICLE WASH

CARROLL

Hand or power vehicle wash produces a glossy shine and protects the finish. Harmless to all automotive finishes including acrylic lacquer and enamels. Works in hot or cold, hard or soft water, loads of scrubbing suds. Contains no solvents or ammonia.

30017828 27828 1 gal.

4/cs.



B. AEROSOL TIRE DRESSING

ZEP

High-gloss, water-resistant, silicone formulation tire dressing. For a uniform, long-lasting shine. Easy-to-use product gives tires a showroom look in seconds. Fast drying. Protects as it shines. VOC compliant.

75070124 R08401 24 oz.

12/cs.



C. FOAMING VEHICLE SHAMPOO

ZEP

Environmentally preferred, ultra-concentrated liquid detergent formulated for friction car and truck washing facilities. Excellent for removing road film, dirt and salt deposits. Won't harm wax finishes.

75070118 R08124 1 gal.

4/cs.

75070119 R08135 5 gal.

1/ea.

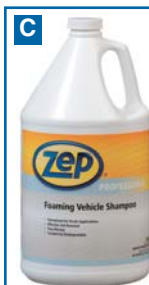

D. TRUCK & TRAILER WASH

ZEP

Premium liquid truck and trailer wash. Removes exhaust deposits, road film, and bug residues from painted vehicle surfaces. Cleans in one application.

75070117 R08035 5 gal.

1/ea.



E. VINYL & RUBBER PROTECTANT

ZEP

Ready-to-use, vinyl and rubber surface dressing. Protects from ozone, UV rays, and oxidation damage. Designed for use on vinyl, rubber, wood, acrylic, and plastic surfaces.

75070122 R08301 1 qt.

12/cs.



HVAC CLEANERS

F. PRIME SOURCE®

SOLVENT COIL CLEANER AEROSOL

PRIME SOURCE®

Removes dirt, lint and grease from air conditioning condensers and refrigeration coils and fins. Contains no solvents, acids or alkalis. Coil cleaning improves efficiency and prevents overheating and burnout.

75004078 75004078 19 oz.

12/cs.



G. PRIME SOURCE®

WATER-BASED COIL CLEANER AEROSOL

PRIME SOURCE®

Water-rinseable foam removes dirt, lint and grease from air conditioning condensers and refrigeration coils and fins. Non-acid, non-alkaline formula dries without residue. Coil cleaning improves efficiency and prevents overheating and burnout.

75004079 75004079 19 oz.

12/cs.





Notes

CHEMICALS

Bar Soaps/Powdered Soaps/Hand Soaps



BAR SOAPS

A. DIAL® DEODORANT BAR SOAP

DIAL

Provides superior antibacterial effectiveness and deodorant protection.

15200280 00910 3½ oz., Gold, Retail Wrap 72/cs.



B. DOVE® BAR SOAP

DIVERSEY

Recommended by dermatologists. Ideal for infant and long-term care. Non-irritating, non-soap moisturizing formula contains one quarter moisturizing cream and is milder to skin than any soap. Available in convenient travel-sized bar.

15200044 CB614243 3½ oz., White 48/cs.
15200015 CB610795 4¼ oz., 8 Pack, White 72/cs.



C. LUX® BAR SOAP

DIVERSEY

Economical, pure beauty soap that leaves skin feeling clean and fresh. Superior lather, mild fragrance.

15200128 2979831 3.2 oz. 73/cs.



D. IVORY® BAR SOAP

PROCTER & GAMBLE

Classic soap bar contains no heavy perfumes, creams or dyes.

16902137 12364 3.1 oz., 3-Pack 72/cs.



E. LAVA® BAR SOAP

WD-40

The original heavy-duty hand cleaner. Specially formulated with pumice power to get even the dirtiest hands clean, and with the help of added moisturizers, keeps hands from feeling rough.

51840383 10383 4 oz. 48/cs.



POWDERED SOAPS

F. BORAXO® HEAVY-DUTY HAND SOAP

DIAL

Contains larger granules for quicker cleaning and extra scrubbing action. Combines the scrubbing power of borax with the cleaning power of soap to easily dissolve grease and dirt when washing with water. 100% soluble and safe in septic systems.

12802858 02303 5 lb. 10/cs.

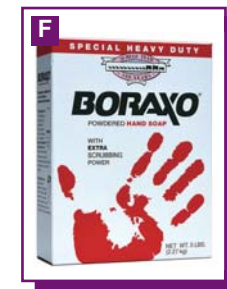

G. BORAXO® POWDERED HAND SOAP

DIAL

Dual action Boraxo® hand soap combines the scrubbing power of borax with the cleaning power of soap to easily dissolve grease and dirt when washing with water. 100% soluble and safe in septic systems.

12800030 02203 5 lb. 10/cs.

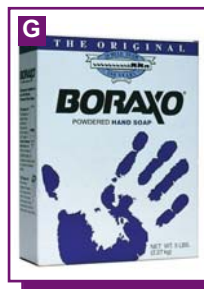

HAND SOAPS

H. PRIME SOURCE® ECONO COCONUT HAND SOAP

PRIME SOURCE®

Economical all natural formulation.

75004221 75004221 1 gal. 4/cs.



I. PRIME SOURCE® SILKY HAND SOAP

PRIME SOURCE®

All natural formulation. Luxurious rich lather. Mild on skin.

75004224 75004224 1 gal. 4/cs.
76008533 76008533 3.78 L 4/cs.
75004225 75004225 55 gal. 1/ea.



J. PRIME SOURCE® SMOOTH COCONUT HAND SOAP

PRIME SOURCE®

All natural formulation produces luxurious rich lather and is pH balanced. Almond fragrance.

75004226 75004226 1 gal. 4/cs.
75004227 75004227 55 gal. 1/ea.



SOAPS

Hand Soaps/Medicated Soaps



SOAPS



A. PRIME SOURCE® SUPER PINK HAND SOAP **PRIME SOURCE®**
 Formulated to clean and help keep your skin soft and healthy.
 75004203 75004203 1000 mL 8/cs.
 75004204 75004204 2000 mL 4/cs.



B. CARE-ALL HAND CLEANSER **CARROLL**
 Creamy soap leaves skin smooth and soft. The pH balanced synthetic blend doesn't leave soap scum. Thick liquid may be diluted 1:1 where less viscosity desired. Opaque pink color. Almond fragrance.
 30016428 56428 1 gal. 4/cs.



C. TODAY'S CHOICE ALL PURPOSE HAND SOAP **CARROLL**
 Designed for economically efficient skin cleansing and conditioning in general use, hand or body washing. This thick, pink, pearlescent product is pH balanced for extra mildness. Provides copious lather and a fresh, pleasant fragrance. Does not leave a soap film. Ideal in washrooms and shower rooms in institutional, industrial and commercial facilities.
 30010024 50617 800 mL 12/cs.



D. SOFTSOAP® ELEMENTS LIQUID HAND SOAP REFILL **COLGATE-PALMOLIVE**
 Leave your hands feeling clean and smelling fresh. Great for use in bathrooms or kitchen areas.
 11900051 26991 56 oz. 6/cs.



E. DOVE® HAND SOAP **DIVERSEY**
 Extra mild hand cleaner designed for frequent hand washing environments. Ultra mild ingredients gently remove soil and bacteria without drying, chapping or irritating skin. Minimizes the damage caused by repeated removal of essential oils from the skin. Easy training with trilingual labeling.
 15200116 2979401 1 gal. 4/cs.



F. KIMCARE® GENERAL ULTRA-KIND® GENTLE HAND WASH **KIMBERLY-CLARK**
 A gentle cleanser with a pH balanced formula that leaves hands soft and smooth. Dye-free formula with aloe vera.
 15402519 92519 500 mL 18/cs.



G. PRIME SOURCE® ANTIMICROBIAL HAND SOAP **PRIME SOURCE®**
 High quality, low-cost lotion soap with antibacterial agent. Kills germs while providing gentle cleansing. Floral balsam fragrance.
 75004215 75004215 1 gal. 4/cs.



H. PRIME SOURCE® E2 SANITIZING HAND SOAP **PRIME SOURCE®**
 Formulated to clean, kill germs and help keep your skin soft and healthy.
 75004232 75004232 2000 mL, Amber 4/cs.



I. PRIME SOURCE® GOLDEN ANTIMICROBIAL HAND SOAP **PRIME SOURCE®**
 Formulated to clean and kill germs while helping keep your skin soft and healthy.
 75004202 75004202 800 mL 12/cs.
 75004205 75004205 1000 mL 8/cs.
 75004206 75004206 2000 mL 4/cs.

MEDICATED SOAPS

Medicated Soaps



A. PRIME SOURCE® SEPTISURGE ANTISEPTIC HAND CLEANER **PRIME SOURCE®**
 Contains Triclosan for broad spectrum germ control on skin. Made with pure coconut oil.
 75004214 75004214 1 gal. 4/cs.



B. PALPON® ANTIBACTERIAL LOTION SOAP **CARROLL**
 Economical antimicrobial soap reduces germs and bacteria. Coconut oil-based lotionized soap designed for frequent use. Creates excellent lather without drying skin. Pink opaque color and pleasant almond fragrance. USDA E1.
 30010238 55728 1 gal. 4/cs.



C. SOFTSOAP® ANTIBACTERIAL HAND SOAP W/MOISTURIZERS **COLGATE-PALMOLIVE**
 Clinically proven to eliminate 99% of germs. Offers strong antibacterial protection. Gently cleans without leaving hands feeling dry. Light moisturizers help keep skin feeling smooth and soft. Dermatologist-tested.
 11900094 26238 7 1/2 oz. \$ 12/cs.
 11901929 01929 800 mL 12/cs.
 11900002 01901 1 gal. 4/cs.



D. SOFTSOAP® ANTISEPTIC HAND WASH **COLGATE-PALMOLIVE**
 Contains chloroxylenol to help eliminate dirt and germs on hands. Mild formula with a clean medicinal fragrance.
 11901930 01926 800 mL 12/cs.



E. DIAL® GOLD LIQUID ANTIMICROBIAL SOAP **DIAL**
 Broad spectrum antimicrobial effectiveness with added skin conditioners for mildness.
 12800011 84014 7 1/2 oz. Decor Pump 12/cs.
 12800790 80790 16 oz. Pump 12/cs.
 12807501 97501 800 mL Flex Pak 12/cs.
 12804009 84019 1 L 8/cs.
 12802738 88047 1 gal. 4/cs.



F. LIQUID DIAL® MOISTURIZING ANTIMICROBIAL SOAP **DIAL**
 Broad spectrum antimicrobial effectiveness with extra moisturizers and conditioners including vitamin E to protect against dry skin. Ideal for frequent hand washing.
 12804028 84029 1 L, Refill Jug 8/cs.



G. LIQUID DIAL® SENSITIVE SKIN ANTIMICROBIAL SOAP **DIAL**
 Broad spectrum antimicrobial effectiveness. Extra mild, and formulated for very frequent hand washing. Hypoallergenic and dermatologist tested for even the most sensitive skin.
 12802838 82838 1 gal. 4/cs.



H. SWEETHEART® ANTIBACTERIAL LOTION SOAP **DIAL**
 Economical high-quality hand soap contains Triclosan for effective antibacterial protection. Light, pleasing fragrance, unlike soaps with PCMX.
 12806507 96507 800 mL 12/cs.



I. LEVER 2000® ANTIBACTERIAL LIQUID SOAP **DIVERSEY**
 Cleans and effectively reduces bacteria counts on the skin. Contains 0.25% Triclosan. Easy training with trilingual labeling.
 15200125 2979662 14 oz. Pump 12/cs.
 15200011 2980196 1 gal. 4/cs.



SOAPS

Medicated Soaps



A. GOJO® GOLD & KLEAN ANTIMICROBIAL LOTION SOAP GOJO

Economical natural lotion formula contains chloroxylenol (PCMX), a broad-spectrum antimicrobial agent. Mild formula helps promote frequent handwashing while killing germs.
35402712 912712 800 mL 12/cs.

B. GOJO® RICH PINK ANTIBACTERIAL LOTION SOAP GOJO

A high performance, gentle antibacterial lotion soap. For cleaning light soils.
35400017 722004 2000 mL 4/cs.
35407520 752002 5000 mL 2/cs.

C. GOJO® THICK PINK ANTISEPTIC SOAP GOJO

Economical lotion soap provides germ-killing action. Contains 0.3% chloroxylenol (PCMX). For general restroom use. Pleasant fragrance.
35401845 184504 1 gal. Flat Top 4/cs.

D. GOJO® ULTRA MILD ANTIMICROBIAL LOTION SOAP GOJO

Lotion soap formula combines mild cleansers with 0.6% chloroxylenol (PCMX), a broad-spectrum antimicrobial agent. For gentle handwashing and effective germ killing.
35409212 921212 800 mL 12/cs.
35401208 211208 1000 mL, Fits NXT® 8/cs.
35400079 221204 2000 mL, NXT® Maximum Capacity™ 4/cs.

E. MICRELL® ANTIBACTERIAL LOTION SOAP GOJO

Kills germs, yet is gentle on hands even after repeated daily washings. Contains quick-acting antimicrobial agent chloroxylenol (PCMX) and an effective degreaser.
35409752 975212 8 oz., Pump Bottle 12/cs.
35400039 975912 12 oz., Pump Bottle 12/cs.
35409755 975504 1 gal. 4/cs.
35409756 975606 800 mL, Fits 800 Series 6/cs.
35409758 975712 800 mL, Fits 800 Series 12/cs.
35405704 215704 1000 mL, Fits NXT® 4/cs.
35405708 215708 1000 mL, Fits NXT® 8/cs.
35408810 718810 1000 mL, Fits 1000 Series 10/cs.
35400059 225704 2000 mL, NXT® Maximum Capacity™ 4/cs.

F. PROVON® ANTIMICROBIAL LOTION SOAP GOJO

Antimicrobial handwash for general purpose use. Kills most common germs that may cause disease. Contains the broad-spectrum antimicrobial agent 0.3% chloroxylenol (PCMX).
35404212 421210 1000 mL, Fits 1000 Series 10/cs.
35401808 211808 1000 mL, Fits NXT® 8/cs.
35401804 221804 2000 mL, NXT® Maximum Capacity™ 4/cs.

G. PROVON® MEDICATED LOTION SOAP GOJO

Medicated hand cleanser with 0.3% chloroxylenol (PCMX) combines effective broad-spectrum antimicrobial activity with skin conditioners and emollients. Light citrus fragrance.
35404203 420124 4 oz., Squeeze Bottle 24/cs.

H. KIMCARE® ALL-N-1 ANTIBACTERIAL SKIN CLEANSER KIMBERLY-CLARK

A mild, general-purpose antibacterial cleanser. Its active ingredient, .25% Triclosan, helps protect against the spread of potentially harmful bacteria.
15405154 95154 1.5 L, White 4/cs.

I. KLEENEX® ANTIBACTERIAL SKIN CLEANSER KIMBERLY-CLARK

A mild, general-purpose antibacterial cleanser designed for everyday use. Its active ingredient, 0.25% Triclosan, helps protect against the spread of potentially harmful bacteria.
15401547 91547 800 mL 12/cs.
15401016 91559 1000 mL 6/cs.

J. SCOTT® ANTIBACTERIAL SKIN CLEANSER KIMBERLY-CLARK

A mild, general-purpose antibacterial cleanser designed for everyday use. Its active ingredient, 0.5% PCMX, helps protect against the spread of potentially harmful bacteria. Straw color.
15401298 91298 800 mL 12/cs.

Medicated Soaps/Lotion Soaps



A. SCOTT® CLEAR ANTIBACTERIAL SKIN CLEANSER KIMBERLY-CLARK

A mild, general-purpose antibacterial cleanser designed for everyday use. Its active ingredient, 0.25% Triclosan, helps protect against the spread of potentially harmful bacteria. 15401547 91547 800 mL 12/cs.



B. SAFEGUARD® ANTIBACTERIAL SOAP PROCTER & GAMBLE

Contains the proven antibacterial ingredient Triclosan to help minimize the threat of a broad spectrum of bacteria. Contains a moisturizing ingredient to help fight dry skin. 16900034 07010 1 gal. 2/cs.



C. LYSOL® HEALTHY TOUCH NO-TOUCH HAND SOAP SYSTEM RECKITT BENCKISER

Automatically senses your hands and dispenses just the right amount of soap that kills 99.9% of bacteria. For use in the kitchen or bathroom, the antibacterial hand soap is enriched with moisturizing ingredients and comes in three great scents. Never touch a germ soap pump again.

58340061 00061 Kit: 1 Dispenser & 1 Refill, 8.5 oz., Soothing Cucumber Splash 4/cs.
58340062 00062 Refill Only, 8.5 oz., Soothing Cucumber Splash 6/cs.



D. LYSOL® I.C.™ ANTIMICROBIAL SOAP RECKITT BENCKISER

Broad spectrum antimicrobial effectiveness to help reduce the spread of germs. Pleasant fragrance, mild and non-drying to skin. Lathers in both hard and soft water for maximum cleaning under all conditions. NSF Category Code E4.

58345717 95717 17½ oz., Pump Bottle 12/cs.
58345701 95701 1 gal. 4/cs.



E. LYSOL® NO-TOUCH™ ANTIBACTERIAL HAND SOAP REFILL RECKITT BENCKISER

Kills 99.9% of bacteria as it is dispensed. Enriched with moisturizing ingredients. For Lysol Healthy Touch No-Touch Hand Soap System.

58340066 00066 8½ oz., Refreshing Grapefruit 6/cs.



F. MILD ANTIMICROBIAL HAND CLEANER ZEP

Mild hand cleaner, uses Triclosan to effectively remove soils and bacteria without harming hands. Fresh, clean fragrance. Contains emollients to leave hands feeling soft and smooth.

75070078 R05206 500 mL, Pump Bottle 12/cs.
75070079 R05224 1 gal. 4/cs.



LOTION SOAPS

G. PRIME SOURCE® CARACO PINK LOTION HAND SOAP PRIME SOURCE®

Blended with the finest whole pure imported coconut oil; almond fragrance. Glycerin emollients retained for extra mildness to skin.

75004219 75004219 1 gal. 4/cs.



H. PRIME SOURCE® LOTION HAND SOAP PRIME SOURCE®

Formulated to clean and help keep your skin soft and healthy. 75004201 75004201 800 mL 12/cs.



I. CLEAN N' FRESH® LOTION HAND SOAP PLUS CARROLL

Combines gentle skin cleansing with the antiseptic ingredient parachlorometaxylenol, to protect the skin from transient bacteria. Contains a lotion-enhanced skin care formula for mildness. Provides rich creamy lather, even in hard water, leaving a clean, fresh fragrance.

30010025 51117 800 mL 12/cs.



J. SOFTSOAP® LIQUID SOAP W/ALOE COLGATE-PALMOLIVE

The #1 brand in liquid hand soaps. Gentle cleansing formula with a touch of aloe vera. Less drying than ordinary soap. Proven to eliminate tough dirt on hands. Dermatologist-tested.

11901120 26012 7½ oz., Pump Bottle 12/cs.
11901820 01924 800 mL 12/cs.
11901900 01900 1 gal. 4/cs.



SOAPS

Lotion Soaps



A. DIAL® BASICS HYPOALLERGENIC LIQUID SOAP DIAL

A mild liquid lotion soap that is gentle on the skin. With its fresh floral fragrance and rich lotion look and feel, Dial® Basics soap is a premium product with an emphasis on value.

12800052	170006046	1 L	8/cs.
12806047	06047	1 gal.	4/cs.

B. PURE & NATURAL® LIQUID LOTION SOAP DIAL

A hypoallergenic mild liquid lotion soap that is gentle on the skin. A fresh floral fragrance and rich lotion look and feel make this soap perfect for any commercial setting.

12800629	00629	1 L	8/cs.
----------	-------	-----	-------

C. SWEETHEART® PINK LOTION SOAP DIAL

This pearlescent lotion soap is an excellent cost-effective choice for use in almost any facility.

12809506	99506	800 mL (Flex Pack)	12/cs.
----------	-------	--------------------	--------

D. H2 ENRICHED LOTION SOAP DIVERSEY

Rich lathering premium soap. Developed for those who frequently wash their hands. Proven to be mild on the skin even after repeated use.

15206410	3358964	1 L	12/cs.
----------	---------	-----	--------

E. CAREX® LOTION CLEANSER GEORGIA-PACIFIC

Pink pearlescent general use lotion soap that is pH-balanced. Cartridges fit into convenient, easy-to-install dispensers for a clean, cost-effective alternative to expensive, messy bar soaps and low-quality liquid/powder soaps. USDA E1 rating.

13704802	48020	1 L	10/cs.
----------	-------	-----	--------

F. GOJO® DELUXE LOTION SOAP W/MOISTURIZERS GOJO

Luxurious lotion soap with vitamins A and E to clean hands gently, even with frequent use. For public facilities, offices, and general restroom use. Fresh, light floral fragrance.

35401708	211708	1000 mL, Fits NXT®	8/cs.
35400080	221704	2000 mL, NXT® Maximum Capacity™	4/cs.

G. GOJO® ENRICHED LOTION SOAP GOJO

Gentle, concentrated natural lotion soap with moisturizers. For general restroom use. Pleasant, light fragrance.

35409102	910212	800 mL	12/cs.
----------	--------	--------	--------

H. GOJO® GREEN CERTIFIED LOTION HAND CLEANER GOJO

A mild, biodegradable lotion soap formula certified by Green Seal™ and EcoLogo® to meet their joint standard (GS41/CCD-104) for hand cleaners and hand soaps.

35406512	916512	800 mL	12/cs.
35402165	216508	1000 mL, Fits NXT®	8/cs.

I. GOJO® LOTION SKIN CLEANSER GOJO

Mild cleansing lotion soap. For general restroom use. Pink, synthetic detergent formula.

35409113	911212	800 mL	12/cs.
----------	--------	--------	--------

J. GOJO® PINK & KLEAN SKIN CLEANSER GOJO

Rich, pearlized pink lotion soap formulated for extra value. Gentle cleansing with a clean rinse. Pleasant, light floral fragrance.

35400031	912812	800 mL	12/cs.
----------	--------	--------	--------

K. GOJO® WHITE COCONUT SKIN CLEANSER GOJO

A quality cleansing lotion that is mild to the skin. Ideal for general restroom use. Coconut fragrance.

35401812	181204	1 gal.	4/cs.
----------	--------	--------	-------

L. GOJO® WHITE PREMIUM LOTION SOAP GOJO

Rich, luxurious lather with a white, satin appearance. Dye-free formula with a fresh.

35409104	910412	800 mL	12/cs.
----------	--------	--------	--------

Lotion Soaps/Foaming Soaps



A. KIMCARE® GENERAL GENTLE LOTION SKIN CLEANSER W/DISPENSER KIMBERLY-CLARK

Gentle lotion cleanser that removes light soils. Its neutral pH formula has a rich, creamy lather and pleasant floral fragrance. ALL-N-1 is a replaceable soap system that provides a new, clean dispenser with each refill.

15405253	95253	2.5 L, Black	4/cs.
15400253	96253	2.5 L, White	4/cs.



B. KLEENEX® GENTLE LOTION SKIN CLEANSER KIMBERLY-CLARK

Gentle lotion cleanser that removes light soils. Offers flexibility with interchangeable foam or lotion skin care cassettes and dispensers compatible with universal mounting brackets also used in the ALL-N-1 product line.

15401018	91556	1000 mL	6/cs.
----------	-------	---------	-------



C. SCOTT® GENTLE LOTION SKIN CLEANSER KIMBERLY-CLARK

Gentle lotion cleanser that removes light soils.

15400054	92053	500 mL	18/cs.
15400055	91211	800 mL	12/cs.



D. SCOTT® PINK LOTION SKIN CLEANSER KIMBERLY-CLARK

Provides gentle cleaning. Easy-to-rinse lather and peach fragrance.

15401923	91923	700 mL	4/cs.
15401220	91220	800 mL	12/cs.
15401300	91300	1 gal.	4/cs.



E. SCOTT® TRIANGLE® LOTION SOAP KIMBERLY-CLARK

An all purpose, synthetic hand lotion cleanser for removing light soils from the skin. Green with a floral scent.

15400047	91241	800 mL	12/cs.
----------	-------	--------	--------



FOAMING SOAPS

F. PRIME SOURCE® ANTIBACTERIAL FOAMING HAND SOAP PRIME SOURCE®

Gentle antimicrobial foaming hand wash. Formulated to clean, kill germs and help maintain soft healthy skin.

75004229	75004229	1200 mL, US Label	2/cs.
76004253	76004253	1200 mL, Canada Label	2/cs.
75004228	75004228	1200 mL, Canada Label	3/cs.
75004237	75004237	1250 mL, US Label	3/cs.
75004256	75004256	1500 mL	2/cs.
75004240	75004240	2000 mL	2/cs.



G. PRIME SOURCE® BOTANICAL FOAMING HANDWASH PRIME SOURCE®

Offers luxurious lather and a pleasant botanical fragrance. Vibrant green color. Enriched with moisturizers, natural extracts and skin conditioners. USDA certified biobased formulation. EcoLogo® Certified.

75000130	75000130	700 mL, ADX-7™ Refill	4/cs.
75000140	75000140	1250 mL, ADX-12™ Refill	3/cs.



H. PRIME SOURCE® CLEAR & MILD FOAMING HANDWASH PRIME SOURCE®

Spa-inspired, green certified foaming hand soap offering a luxurious foam lather in a fragrance- and dye-free formulation. Enriched with moisturizers and skin conditioners. USDA certified biobased formulation. EcoLogo® Certified. Delights users while supporting a healthy environment.

75000128	75000128	700 mL, ADX-7™ Refill	4/cs.
75000144	75000144	700 mL, LTX-7™ Refill	3/cs.
75000138	75000138	1250 mL, ADX-12™ Refill	3/cs.
75000149	75000149	1200 mL, LTX-12™ Refill	2/cs.



SOAPS

Foaming Soaps



A. PRIME SOURCE® E2 SANITIZING FOAMING HAND SOAP **PRIME SOURCE®**
 Formulated to clean and help keep your skin soft and healthy.

75004246	<i>75004246</i>	1250 mL	3/cs.
75004247	<i>75004247</i>	2000 mL	2/cs.

B. PRIME SOURCE® FOAMING HAND SOAP **PRIME SOURCE®**
 Rich gentle luxury foaming hand wash. Formulated for an effective, pleasing hand wash experience. For general and light-duty cleaning. Fresh lavender fragrance.

75004253	<i>75004253</i>	1200 mL	2/cs.
-----------------	-----------------	---------	-------

C. PRIME SOURCE® FOAMING LOTION HAND SOAP **PRIME SOURCE®**
 Formulated to clean and help keep your skin soft and healthy.

75004236	<i>75004236</i>	1250 mL	3/cs.
75004244	<i>75004244</i>	1500 mL	2/cs.
75004239	<i>75004239</i>	2000 mL	2/cs.

D. PRIME SOURCE® G2 FOAMING SOAP **PRIME SOURCE®**
 A mild, biodegradable foaming soap formula. Green Seal™ and EcoLogo® approved.

75004261	<i>75004261</i>	1200 mL	2/cs.
75004260	<i>75004260</i>	1250 mL	3/cs.
75004262	<i>75004262</i>	1500 mL	2/cs.



E. PRIME SOURCE® PLUM ANTIBACTERIAL FOAMING HANDWASH **PRIME SOURCE®**
 High-performance, antibacterial hand soap offering a luxurious lather and an appealing plum fragrance. Attractive purple color. Enriched with a moisturizer, natural extract and skin conditioner. USDA certified biobased formulation.

75000133	<i>75000133</i>	700 mL, ADX-7™ Refill	4/cs.
75000146	<i>75000146</i>	700 mL, LTX-7™ Refill	3/cs.
75000141	<i>75000141</i>	1250 mL, ADX-12™ Refill	3/cs.
75000151	<i>75000151</i>	1200 mL, LTX-12™ Refill	2/cs.



F. PRIME SOURCE® POMEBERRY FOAMING HANDWASH **PRIME SOURCE®**
 Spa-inspired green certified foaming hand soap offering a luxurious lather and a pleasant pomegranate fragrance. Appealing blue color. Enriched with moisturizer, natural extract and skin conditioner. USDA certified biobased formulation. EcoLogo® Certified. Delights users while supporting a healthy environment.

75000145	<i>75000145</i>	700 mL, LTX-7™ Refill	3/cs.
75000150	<i>75000150</i>	1200 mL, LTX-12™ Refill	2/cs.



G. DIAL COMPLETE® ANTIMICROBIAL FOAMING HAND SOAP **DIAL**
 Patented Activated Triclosan technology significantly reduces the level of germs left on hands after handwashing. Effective against MRSA, VRE, staphylococcus, streptococcus, E. coli and salmonella. Mild, hypoallergenic foaming soap formula contains aloe and glycerin to leave skin soft. High-volume lather uses less soap. NSF Certified for an E2 rating.

12800049	<i>00163</i>	800 mL Refill	6/cs.
12800162	<i>00162</i>	1 L Refill	6/cs.



H. DIAL COMPLETE® FOAMING HAND SOAP **DIAL**
 Patented Activated Triclosan technology provides 25 times better germ-kill than other antimicrobial soaps. Effective against MRSA, VRE, Streptococcus, E. coli, and Salmonella. Hypoallergenic foaming is excellent for frequent hand washing. NSF E-2 Rating.

12802935	<i>02935</i>	7½ oz. Pump, Cool Plum	8/cs.
12802934	<i>02934</i>	7½ oz. Pump, Fresh Pear	8/cs.
12802936	<i>02936</i>	7½ oz. Pump, Regular	8/cs.
12801033	<i>81033</i>	1 L Refill, Cool Plum	4/cs.
12802731	<i>02731</i>	50 oz., Regular	6/cs.



I. DIAL® BASICS FOAMING LOTION SOAP **DIAL**
 A mild, pleasing soap that is gentle on the skin. Dermatologist-tested and hypoallergenic. Rinses clean and is excellent for frequent handwashing.

12800056	<i>06060</i>	1 L Refill	6/cs.
-----------------	--------------	------------	-------

Foaming Soaps



A. GOJO® CX™ LUXURY FOAMING ANTIBACTERIAL HANDWASH GOJO

Smooth, orange foaming handwash with germ-killing power in an orange blossom fragrance.

35405762	576204	535 mL, Pump Bottle	4/cs.
35406203	516203	1250 mL, Fits FMX-12™	3/cs.
35408562	856202	1500 mL, Fits CX™/CXi™	2/cs.
35406202	526202	2000 mL, Fits FMX-20™	2/cs.



B. GOJO® E1 FOAMING HANDWASH GOJO

A foaming handwash that is gentle to the skin but effective for the removal of fats, oils and soils commonly associated with food processing. Meets guidelines for use in USDA and US federally regulated food processing facilities. Listed with NSF International. Certified kosher.

35406703	516703	1250 mL	3/cs.
-----------------	--------	---------	-------



C. GOJO® GREEN CERTIFIED FOAMING HAND CLEANER GOJO

A mild, biodegradable foaming soap formula certified by Green Seal™ and EcoLogo® to meet their joint standard (GS41/CCD-104) for hand cleaners and hand soaps.

35405715	571506	7½ oz., Tabletop Bottle	6/cs.
35405665	566502	1200 mL, TFX™ Refill	2/cs.
35405166	516503	1250 mL, Fits FMX-12™	3/cs.
35405725	572502	46 oz., Refill Bottle	2/cs.
35408560	856502	1500 mL, Fits CX™/CXi™	2/cs.
35405266	526502	2000 mL, Fits FMX-20™	2/cs.



D. GOJO® HONEY ALMOND FOAMING SOAP GOJO

Bulk foaming soap with a honey almond scent.

35400175	500504	1 gal.	4/cs.
-----------------	--------	--------	-------



E. GOJO® LUXURY FOAMING HANDWASH GOJO

Rich, gentle luxury foaming handwash, pre-lathered for a convenient and pleasing experience. For general, light-duty cleaning. Translucent pink color and cranberry fragrance.

35406103	516103	1250 mL, Fits FMX-12™	3/cs.
35408561	856102	1500 mL, Fits CX™/CXi™/CXac™	2/cs.
35405261	526102	2000 mL, Fits FMX-20™	2/cs.

F. GOJO® PREMIUM FOAMING ANTIBACTERIAL HANDWASH GOJO

Kills germs on hands while providing a rich, luxurious lather. Gentle on hands. Contains vitamin E and aloe. Fresh fruit fragrance.

35405710	571006	7½ oz., Pump Bottle	6/cs.
35405362	536202	1200 mL, TFX™ Refill	2/cs.
35405720	572002	46 oz., Refill	2/cs.



G. GOJO® TFX™ PREMIUM FOAMING HANDWASH W/SKIN CONDITIONERS GOJO

Provides rich, thick lather for a luxurious handwashing experience. Gentle on skin. Pleasant cranberry fragrance. Translucent purple color.

35405361	536102	1200 mL	2/cs.
-----------------	--------	---------	-------



H. PROVON® FOAMING HANDWASH W/MOISTURIZERS GOJO

High-quality, luxurious foaming hand soap formulated with moisturizers and conditioners. General-purpose, mild formula. Cranberry fragrance.

35405189	518503	1250 mL, Fits FMX-12™	3/cs.
-----------------	--------	-----------------------	-------

I. PROVON® FOAMING ANTIMICROBIAL HANDWASH GOJO

Germ-killing foaming handwash with moisturizers. Light floral fragrance. Contains 0.3% chloroxylenol (PCMX).

35405186	518603	1250 mL, Fits FMX-12™	3/cs.
-----------------	--------	-----------------------	-------

J. PROVON® TFX™ FOAMING HANDWASH GOJO

Ultra mild foaming soap formula combines rich, luxurious lather with advanced skin moisturizers. A general-purpose, extremely mild handwashing formula. Gentle on skin.

35405385	538502	1200 mL, Cranberry Fragrance, Advanced Moisturizers	2/cs.
-----------------	--------	---	-------

SOAPS

Foaming Soaps/Industrial Soaps



SOAPS



A. KLEENEX® ANTIBACTERIAL FOAM SKIN CLEANSER KIMBERLY-CLARK

The Cassette Skin Care System features innovative refills with interchangeable foaming or lotion skin care cassettes. Fresh pump with each refill for greater hygiene and a better image. 0.5% Triclosan, helps protect against the spread of potentially harmful bacteria. Clear with a fruit fragrance.

15401554 91554 1000 mL 6/cs.

B. KLEENEX® FOAM SKIN CLEANSER W/MOISTURIZERS KIMBERLY-CLARK

The Cassette Skin Care System offers flexibility with interchangeable foaming or lotion skin care cassettes and dispensers compatible with universal mounting brackets also used in the All-N-1 product line. Light pink with a floral scent.

15401552 91552 1000 mL 6/cs.

C. TORK® PREMIUM ANTIBACTERIAL FOAMING SOAP SCA TISSUE

Kills 99.9% potentially harmful bacteria commonly found in food service and healthcare environments. NSF registered formulation meets the E2 requirements for food preparation areas. Mild formula for frequent use. Leaves no residue on skin - pH balanced, fragrance and dye-free. More hand washings per refill and high capacity results in low cost-in-use. Refills reduce packaging waste, which is easier on the environment.

14100217 400212 800 mL, S21 Refill 5000/cs.

D. TORK® PREMIUM FOAMING SOAP W/MOISTURIZERS SCA TISSUE

Green Seal™ Certified. Extra mild, leaves hands smooth and soft. Tork foaming soap is enriched with conditioners for frequent use. Leaves no residue on skin. pH balanced to enhance the soaps mild character.

14100234 400211 1100 mL 6/cs.

E. OPTISOURCE® FOAMING LOTION SOAP WAUSAU PAPER/BAY WEST

Ideal for multipurpose needs in lavatories and designed to replace expensive bar soaps as well as low-quality liquid and powder soaps. Green Seal™ Certified.

30039101 91300 1000 mL 4/cs.

INDUSTRIAL SOAPS

F. CREME HAND CLEANER GOJO

Crema formula for removing grease, tar and oil. Rub, then wipe clean with a towel or rinse off. No harsh solvents.

35404112 114112 14 oz. 12/cs.

G. GOJO® CHERRY GEL PUMICE HAND CLEANER GOJO

Gel-style heavy-duty hand cleaner with cherry fragrance and pumice scrubbers quickly cleans heavy dirt, grease and oil. pH balanced to promote skin comfort. Provides a quick, easy and complete rinse that leaves skin feeling refreshed.

35402358 235802 1 gal., Pump Bottle 2/cs.

H. GOJO® FINE ITALIAN PUMICE HAND CLEANER GOJO

Crema formula with fine Italian pumice scrubbing particles for extra cleaning action. For removing heavy grease, tar and oil.

35403506 113506 4 lb. 6/cs.

I. GOJO® LEMON PUMICE HAND CLEANER GOJO

Crema formula with fresh lemon fragrance and pumice scrubbers. For removing grease, tar, and oil. No harsh solvents.

35400915 091506 4 1/2 lb. Cartridge 6/cs.

J. GOJO® MULTI GREEN® HAND CLEANER GOJO

A popular multi-purpose hand cleaner for removing light to medium industrial soils and dirt. Contains a natural, citrus solvent cleaner and non-abrading scrubbing particles.

35409172 917212 800 mL 12/cs.

35400018 726504 2000 mL 4/cs.

35400042 756502 5000 mL 2/cs.

Industrial Soaps



A. GOJO® NATURAL ORANGE™ PUMICE HAND CLEANER GOJO

Quick-acting lotion formula with scrubbing particles for cleaning a broad range of industrial soils, medium dirt and grease. Orange citrus scent.

35400957	095712	14 oz., Grippit™ Bottle	12/cs.
35400958	095806	1/2 gal. Pump Dispenser	6/cs.
35407255	725504	2000 mL, Pro™ 2000	4/cs.
35400054	095504	1 gal., Pump Dispenser	4/cs.
35405602	755602	5000 mL, Pro™ 5000	2/cs.



B. GOJO® NATURAL ORANGE™ SMOOTH HAND CLEANER GOJO

Quick-acting lotion formulation with an orange citrus scent for cleaning a broad range of industrial soils, medium dirt and grease.

35400945	094504	1 gal., Pump Dispenser	4/cs.
----------	--------	------------------------	-------



C. GOJO® ORANGE HAND CLEANER GOJO

Creme formula with citrus ingredients. For removing grease, tar and oil. Use with or without water. Rub and wipe clean with a towel or rinse off. No harsh solvents.

35400965	096506	4½ lb. Cartridge	6/cs.
----------	--------	------------------	-------



D. GOJO® ORANGE PUMICE HAND CLEANER GOJO

Creme formula with orange citrus ingredients and natural pumice scrubbers. For removing grease, tar and oil. Use with or without water.

35400975	097506	4½ lb. Cartridge	6/cs.
----------	--------	------------------	-------

E. GOJO® ORIGINAL FORMULA HAND CLEANER GOJO

Original creme formula containing lanolin and soothing emollients for removing heavy grease, tar, and oil. Use with or without water. Wipe clean with a towel or rinse off.

35401318	110912	14 oz.	12/cs.
35400006	111506	4½ lb.	6/cs.

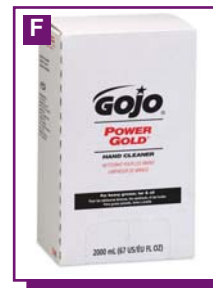

F. GOJO® POWER GOLD® HAND CLEANER GOJO

A highly effective, fast-acting hand cleaner for removing the heaviest grease, tar and oil. No harsh solvents. Contains natural, non-irritating scrubbing particles.

35400988	098802	1/2 gal., Pump Bottle	2/cs.
35400014	729504	2000 mL, Pro™ 2000	4/cs.
35407595	759602	5000 mL, Pro™ 5000	2/cs.



G. GOJO® PROFESSIONAL PAINT & STAIN HAND CLEANER GOJO

Uniquely formulated hand cleaner for quickly removing a variety of paints, stains and inks. Contains a highly effective, safe, plant-derived solvent and no petroleum distillates.

35401016	101612	5 oz., w/Counter Display	12/cs.
----------	--------	--------------------------	--------

H. GOJO® SUPRO MAX™ HEAVY-DUTY HAND CLEANER GOJO

Fast and effective lotion hand cleaner removes tough, sticky soils and adhesives while leaving skin conditioned and healthy feeling. Unique blend of cleaners, skin conditioners, and gentle scrubbers. Ideal for plant-wide use. Non-drying formula.

35407204	727204	2000 mL, Pro™ 2000	4/cs.
35407202	757202	5000 mL, Pro™ 5000	2/cs.



I. SCOTT® NATURALLY TUFF ORANGE HAND CLEANSER W/GRIT KIMBERLY-CLARK

Designed to remove tougher grime without water. Contains polymer beads for scrubbing without the abrasion associated with other grits. Has a fresh, citrus scent.

15401057	91057	1 gal., Pump	4/cs.
----------	-------	--------------	-------

J. SCOTT® SUPER-DUTY HAND CLEANSER W/GRIT KIMBERLY-CLARK

Formulated to clean the toughest dirt. Contains aloe vera and no petroleum solvents.

15401757	91757	3.5 L	2/cs.
15400051	91748	8 L	2/cs.

K. SIMPLE GREEN® HAND CLEANER GEL SIMPLE GREEN

Hand cleaner gel with the powerful cleaning ability of Simple Green® while being easy on the hands. Contains natural pumice to help remove stubborn dirt and grease and lanolin for moisturizing and protecting skin.

73432150	42150	5 oz. Tube	12/cs.
73432128	42128	1 gal.	4/cs.



SOAPS

Industrial Soaps/Body/Hair Shampoo



SOAPS

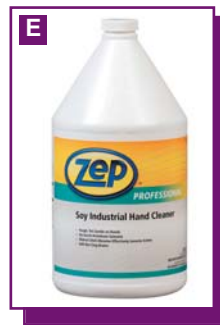
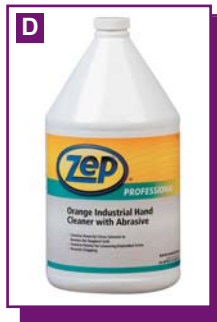
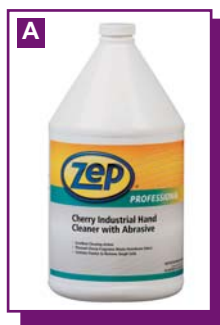

A. CHERRY INDUSTRIAL HAND CLEANER W/ABRASIVE ZEP

Heavy-duty cherry scented hand cleaner with pumice. Removes tough greases, oils, and odors. Contains emollients to moisturize hands and prevent dryness.

75070074 R04824 1 gal. 4/cs.

B. INDUSTRIAL HAND CLEANER W/ALOE VERA ZEP

Premium, mild solvent-based hand cleaner, easily removes grease with tiny scrubbing beads. Formulated with aloe to soothe hands while cleaning.

75070076 R05024 1 gal. 4/cs.

C. INDUSTRIAL HAND CLEANER W/SCRUBBING BEADS ZEP

Heavy-duty hand cleaner with no solvents, will not dry out hands. Contains tiny scrubbing beads to aid in the easy removal of grease and grime without damaging skin.

75070075 R04924 1 gal. 4/cs.

D. ORANGE INDUSTRIAL HAND CLEANER W/ABRASIVE ZEP

Heavy-duty, citrus scented hand cleaner with pumice. Uses citrus solvents to remove tough greases, oils, and odors.

75070077 R05124 1 gal. 4/cs.

E. SOY INDUSTRIAL HAND CLEANER ZEP

Environmentally preferred hand cleaner. Uses a powerful yet mild combination of soy solvents and walnut shell abrasive to loosen tough grime. Apple cinnamon fragrance.

75070080 R05324 1 gal. 4/cs.

BODY/HAIR SHAMPOO

F. PRIME SOURCE® CITRUS FOAMING HAND & SHOWERWASH PRIME SOURCE®

Offers luxurious foaming lather and an appealing citrus ginger fragrance. Vivid citrus green color. Enriched with moisturizers, natural extracts and skin conditioners. USDA certified biobased formulation. EcoLogo® Certified.

75000129 75000129 700 mL, ADX-7™ Refill 4/cs.
75000139 75000139 1250 mL, ADX-12™ Refill 3/cs.

G. PRIME SOURCE® FOAMING HAIR/BODY SHAMPOO PRIME SOURCE®

Foaming formula to clean and help keep your skin soft and healthy.

75004238 75004238 1250 mL 3/cs.
75004241 75004241 2000 mL 2/cs.

H. PRIME SOURCE® HAIR/BODY SHAMPOO PRIME SOURCE®

Formulated to clean and help keep your skin soft and healthy.

75004207 75004207 1000 mL 8/cs.
75004208 75004208 2000 mL 4/cs.

I. PRIME SOURCE® PEARL WHITE HAND & BODY SOAP PRIME SOURCE®

Produces a luxurious lather that is pH balanced and mild on skin. Cherry almond fragrance.

75004222 75004222 1 gal. 4/cs.
75004223 75004223 55 gal. 1/ea.

J. DIAL® BODY & HAIR SHAMPOO DIAL

The fresh, fragrant formula has been specially formulated for effective cleansing of the entire body. The pH balanced formula leaves hair looking silky, shiny and manageable, while added conditioners help keep skin feeling soft and smooth. Dial Body & Hair Shampoo has an appealing, gender-neutral peach fragrance and abundant lather that rinses with ease.

12803986 03986 1 gal. 4/cs.

Body/Hair Shampoo/Hand Sanitizers



A. GOJO® LATHER & KLEAN HAIR & BODY SHAMPOO GOJO

A gentle enriched lotion soap formulated for the body and hair.
35402612 912612 800 mL 12/cs.



B. GOJO® LUXURY FOAMING HAIR & BODY SHAMPOO GOJO

Green, spa-quality foaming body wash and hair shampoo with a cucumber melon scent.
35406303 516303 1250 mL, Fits FMX-12™ 3/cs.



C. GOJO® SHOWER UP® SOAP & SHAMPOO GOJO

Rich hand, hair, and body soap that provides a clean alternative to non-hygienic bar soaps. Ideal for use in health clubs and fitness centers. Synthetic, clean-rinsing formula will not build up on shower walls. Rose-colored with a pleasantly clean fragrance.
35400019 723004 2000 mL 4/cs.
35403002 753002 5000 mL 2/cs.



D. GOJO® SPA BATH® BODY & HAIR SHAMPOO GOJO

Luxurious, enriched formula for hands, hair and body soap. Ideal for use in health clubs and fitness centers. Synthetic, clean-rinsing formula will not build up on shower walls. Pleasant herbal fragrance.
35409152 915212 800 mL Bag-in-Box 12/cs.
35400078 225204 2000 mL NXT® Refill 4/cs.
35400002 915504 1 gal. Flat Top 4/cs.



E. PROVON® ENRICHED SHAMPOO FOR BODY & HAIR GOJO

A clean-rinsing, head-to-toe shampoo and body wash. Combines skin and hair cleansing ingredients in a dermatologist-tested formulation. Highly concentrated, enriched with aloe and vitamin E. Light herbal fragrance.
35404016 401604 1 gal. 4/cs.



HAND SANITIZERS

F. PRIME SOURCE® CLEAR HAND SANITIZER GEL PRIME SOURCE®

Formulated to clean, kill germs and help keep your skin soft and healthy.
75004231 75004231 1000 mL 8/cs.



G. CLEAN N' FRESH® INSTANT HAND SANITIZER W/ALOE CARROLL

Kills 99.9% of bacteria in 15 seconds. Contains aloe and vitamin E for skin conditioning. Convenient; no soap, water, or towel necessary. Clear green gel; fresh aloe fragrance.
30012025 52025 18 oz. 12/cs.



H. CLOROX® ANYWHERE® HAND SANITIZING SPRAY CLOROX

Formulated to kill 99.999% of germs. The non-drying formula contains natural ingredients that keep hands moisturized and soft without leaving a sticky or greasy residue behind. The spray delivery provides excellent coverage and targeted application to areas such as fingernails and knuckles.
38382176 02176 500 mL 12/cs.



I. SOFTSOAP® INSTANT HAND GEL SANITIZER COLGATE-PALMOLIVE

Kills 99% of most common germs within 15 seconds without soap or water. Helps reduce the spread of hand-to-food borne bacteria. No soap, water or towels needed. Evaporates quickly, contains moisturizers and is fragrance-free.
11901922 01922 800 mL 12/cs.



J. DIAL® ANTIBACTERIAL HAND SANITIZER DIAL

Provides convenient, effective germ-kill that works to kill harmful disease-causing germs, yet is gentle on the hands. Kills 99.999% of pathogenic germs in as little as 15 seconds. Effective against bacteria, yeast and molds. Latex and non-latex compatible and NSF E-2 Certified. Dermatologist tested and hypoallergenic. Fragrance and dye-free. Contains added moisturizers and skin conditioners to soften and smooth the hands.
12800685 00685 4 oz. Flip-Top, Fragrance-Free 24/cs.



SOAPS

Hand Sanitizers



SOAPS



A. PURELL® ADVANCED INSTANT HAND SANITIZER FOAM GOJO

The power of Purell®, America's #1 instant hand sanitizer, in a non-aerosol foaming formula. Enhanced with four different skin-conditioning agents that help maintain skin health.

35409204	579204	535 mL, Pump Bottle	4/cs.
35409202	539202	1200 mL, TFX™ Refill	2/cs.
35409203	519203	1200 mL, FMX-12™ Refill	3/cs.

B. PURELL® ADVANCED SKIN NOURISHING INSTANT HAND SANITIZER FOAM GOJO

Provides advanced antimicrobial germ kill and this green certified formula meets EcoLogo® hand sanitizer standard CCD-170 for environmental leadership and proven performance. Made from 100% naturally renewable ethanol, meeting the USDA BioPreferred program biobased content standards. Fragrance-free, dye-free and compatible with latex, nitrile and vinyl gloves, and CHG. Meets CDC and APIC recommendations.

35409804	579804	535 mL, Pump Bottle	4/cs.
35400183	519803	1200 mL, FMX-12™ Refill	3/cs.

C. PURELL® DESK CADDY GOJO

Personalized place-holder for favorite photos.

35409602	9600DC1BLK	8 oz.	12/cs.
----------	------------	-------	--------

D. PURELL® GREEN CERTIFIED INSTANT HAND SANITIZER GOJO

Made from 100% naturally renewable ethanol. Meets the USDA BioPreferred program for biobased content. Readily compostable gel formula. Meets the EcoLogo® hand sanitizer standard CCD-170 for environmental leadership and proven performance.

35400219	969112	8 oz. Bottle	12/cs.
35400221	369112	12 oz. Bottle	12/cs.
35400223	579104	535 mL Bottle	4/cs.
35400222	509103	1200 mL, FMX™ Refill	3/cs.
35400218	549104	1200 mL, TFX™ Refill	4/cs.

E. PURELL® GREEN CERTIFIED INSTANT HAND SANITIZER FOAM GOJO

Made from 100% naturally renewable ethanol. Meets the USDA BioPreferred program for biobased content. Readily biodegradable non-aerosol foam formula. Meets the EcoLogo® hand sanitizer standard CCD-170 for environmental leadership and proven performance.

35400224	519103	1200 mL, FMX™ Refill	3/cs.
35400217	539102	1200 mL, TFX™ Refill	2/cs.

F. PURELL® INSTANT HAND SANITIZER GOJO

Instant hand sanitizer kills 99.99% of most common germs that may cause illness. Works in as little as 15 seconds, with no water or towels needed. Specially formulated with moisturizers to leave hands feeling soft and refreshed. Alcohol-based.

35403796	379636	1/2 oz., Jelly Wrap	36/cs.
35403007	300560	1/2 oz., Pocket Bottle w/Display Bowl	60/cs.
35400624	960624	2 oz., Pump Bottle	24/cs.
35403034	303424	2 oz., Squeeze Bottle, +1 oz. Free	24/cs.
35409652	965124	4 oz., Bottle	24/cs.
35405214	965212CMR	8 oz., Pump Bottle	12/cs.
35405212	965212	8 oz., Pump Bottle	12/cs.
35403053	305312	8 oz. + 4 oz., Pump	12/cs.
35400206	365912	12 oz., Advanced, Pump Bottle	12/cs.
35400044	965912	12 oz., Pump Bottle	12/cs.
35409659	9659D2	12 oz., Pump Bottle w/Holder	6/cs.
35403023	302312	20 oz., Pump Bottle	12/cs.
35409654	965412	250 mL Refill	12/cs.
35409656	965606	800 mL, Fits 800 Series	6/cs.
35409657	965712	800 mL, Fits 800 Series	12/cs.
35405604	215604	1000 mL, Fits NXT®	4/cs.
35405608	215608	1000 mL, Fits NXT®	8/cs.
35402003	545604	1200 mL, TFX™ Refill	4/cs.
35400063	225604	2000 mL, NXT® Maximum Capacity™	4/cs.
35409625	962504	2 L, Pump Bottle	4/cs.

Hand Sanitizers/Hand/Face Wipes



A. PURELL® INSTANT HAND SANITIZER SKIN NOURISHING FOAM GOJO

Alcohol-based foam sanitizer with the exclusive Dermaglycerin System™. Clinically proven to improve skin condition in 14 days. Now Green Certified. Meets EcoLogo® hand sanitizer standard CCD-170 for environmental leadership and proven performance. Made from 100% naturally renewable ethanol. Meets the USDA BioPreferred program for biobased content. Readily biodegradable non-aerosol foam formula. Contains seven moisturizers for optimal skin conditioning. Fragrance-free and dye-free.

35405398 539802 1200 mL, TFX™ Refill 2/cs.



B. PURELL® INSTANT HAND SANITIZER W/ALOE GOJO

Kills 99.99% of most common germs that may cause illness. Works in as little as 15 seconds and no water or towels are needed. Contains aloe and is specially formulated with moisturizers that leave hands feeling soft and refreshed without stickiness or residue.

35403124 963124 4 1/4 oz., Squeeze Bottle 24/cs.

35409675 967412 8 oz., Pump Bottle 12/cs.

35409639 963912 12 oz., Pump Bottle 12/cs.

35403708 213708 1000 mL, Fits NXT® 8/cs.



C. PURELL® MOISTURE THERAPY INSTANT HAND SANITIZER GOJO

A rich lotion, alcohol-based sanitizer that kills 99.99% of germs in 15 seconds. Contains a unique combination of moisturizers to help improve skin condition and leave hands feeling soft. Absorbs quickly into the skin. Meets protocol for Healthcare Personnel Handwash.

Latex and CHG compatible, dermatologist tested. Herbal fruit fragrance. Ethyl alcohol 62%.

35409552 955212CMR 12 oz. Bottle 12/cs.



D. PURELL® PAL PUMP BOTTLE W/HOLDER GOJO

An engaging "pal" that makes Purell® readily available for use. Easy access encourages frequent use to help minimize the spread of germs in the workplace.

35409600 9600PL1 8 oz. 12/cs.

35403118 9600PL1 8 oz. 18/cs.



E. KIMCARE® INSTANT HAND SANITIZER KIMBERLY-CLARK

Kills germs without soap and water. Kills 99.9% of germs in as little as 15 seconds and offers the convenience of waterless application. No water or towels required, just rub it in and get on with your work. Safe for indirect food contact use. Light citrus scent.

Dermatologist tested. Latex glove compatible.

15403066 93066 2 oz. 24/cs.

15409306 93060 8 oz. 12/cs.



F. KIMCARE® MOISTURIZING INSTANT HAND SANITIZER KIMBERLY-CLARK

An advanced hand sanitizer formulated to prevent dry skin while it kills germs. 62% ethyl alcohol formula with patented Microsponge technology provides fast, broad-spectrum antimicrobial action, in a pleasant, lightly-scented lotion.

15403056 93056 8 oz. 12/cs.



HAND/FACE WIPES

G. SCRUBS® HAND CLEANER TOWELS DYMON

A patented, citrus-based formula is combined with a tough, textured blue towel to loosen, dissolve and absorb dirt and grease leaving your hands truly clean. The effectiveness of pumice soap in a one-step, premoistened towel allows you to use Scrubs® Hand Cleaner Towels anywhere, anyplace, anytime!®

31122272 42272 72 ct., 10 1/2" x 12 1/4", Bucket 432/cs.



H. GOJO® FAST WIPES® HEAVY-DUTY HAND CLEANING TOWELS GOJO

Hand cleaning towels for quick clean-up of light greases and oils. For use at the job site or wherever water is not available.

35406283 628206 25 ct. Canister 6/cs.

35406285 628506 60 ct. Toolbox Pack 6/cs.

35406298 629804 130 ct. Bucket 4/cs.



Hand/Face Wipes/Lotion



A. PURELL® HAND SANITIZING TOWELETTES GOJO

Enhance guest experience and satisfaction with economical towelettes that clean and sanitize. Individually wrapped, "on-the-go" amenity item for a wide variety of markets, including foodservice, travel and hospitality. Made with 62% ethyl alcohol, the same active ingredient as Purell® Instant Hand Sanitizer.

35409022 902210 100 ct., 5" x 7" 1000/cs.

B. PURELL® HAND SANITIZING WIPES GOJO

All the germ-killing benefits of Purell®, America's #1 instant hand sanitizer, in a non-linting, durable wipe. Textured for superior cleaning. Water-resistant individual packaging. Ideal for "on-the-go" use when a larger, softer and more premium towel is preferred. Alcohol-based formula kills 99.99% of most common germs that may cause illness. Convenient and easy-to-use in offices, restaurants, health clubs or anywhere else germs may be.

35403602 360206 24 ct. Singles 6/cs.
35409011 901112 35 ct. Canister 12/cs.
35401006 901006 175 ct. Canister 6/cs.
35409116 911306 270 ct. Canister 6/cs.
35400207 911802 1200 ct. Refill Pouch 2/cs.

C. AT EASE® PERSONAL CLEANSING WASHCLOTHS HOSPECO

Pre-moistened wipes with aloe and lanolin formulation. Non-woven, not airlaid paper, provides soothing and gentle feeling of cloth. Extra large wiper completely covers the hand. One wipe does the job. Cling-free; unfolds with little effort. Superior strength. Pleasant fragrance. Alcohol-free. Hypoallergenic. Latex-free.

14503821 HS3899 50 ct., 9" x 13", Flip-Top Reclosable Softpack 600/cs.

D. KLEENEX® SPLASH 'N GO!® HAND & FACE WIPES KIMBERLY-CLARK

Pre-moistened hand and face wipes formulated with aloe and vitamin E.

15405935 75935 35 ct., Re-Sealable Pack 560/cs.
15405211 75211 42 ct., Tub 12/cs.

E. SANI-HANDS® FOR KIDS ANTIMICROBIAL ALCOHOL GEL HAND WIPES SANI PROFESSIONAL

Meets the FDA's Food Code Requirements for a hand sanitizer used prior to handling food (most hand sanitizers on the market require hands to be rinsed after use and before handling food). Proven more effective than hand wash gels alone; physical wiping action is functional in reducing the spread of germs. Provides a way for customers to clean their hands when soap and water are not available. Alcohol-based hand sanitizers reduce the spread of illness and improve attendance. Contains a moisturizer to help prevent skin from drying out (tested and proven to be non-irritating after 25 consecutive uses). Contains 65.9% SD alcohol by volume.

49680034 P97584 300 ct., 7 1/2" x 5 3/8" 1800/cs.

F. SANI-HANDS® II INSTANT HAND SANITIZING WIPES SANI PROFESSIONAL

Meets the FDA's Food Code Requirements for a hand sanitizer used prior to handling food (most hand sanitizers on the market require hands to be rinsed after use and before handling food). Perfect for customers and employees. Ideal for food prep areas, serving stations, checkout/cashier stations, catering, "to-go" meals, fitness centers, and gas pumps when soap and water are not available.

49682084 P92084 300 ct., 6" x 7 1/2" 1800/cs.

LOTION

G. GOJO® HAND MEDIC® PROFESSIONAL SKIN CONDITIONER GOJO

Specifically formulated for professional technicians for use in their work environments. Quickly absorbs, with no greasy after-feel. Use before work, after handwashing, and at night to help maintain the skin's natural protective barrier. Silicone and fragrance-free.

35408150 815012 5 oz. Tube 12/cs.

Soap Dispensers

SOAP DISPENSERS

A. PRIME SOURCE® ADX-7™ SOAP DISPENSERS PRIME SOURCE®

Compact design ideal for tight spaces. Large sight window and skylight allow at-a-glance product monitoring. Easily converts to locked dispenser. Fully ADA compliant. Lifetime guarantee.

75000137	75000137	700 mL, Black	6/cs.
75000136	75000136	700 mL, Gray/White	6/cs.



B. PRIME SOURCE® ADX-12™ SOAP DISPENSERS PRIME SOURCE®

High capacity dispensers that are ideal for high traffic areas. Large sight window, skylight and crystal clear refill bottles make it easy to check fill status. Converts to a locking dispenser at any time by simply removing the key from inside the dispenser. Fully ADA compliant. Lifetime guarantee.

75000143	75000143	1250 mL, Black	6/cs.
75000142	75000142	1250 mL, Gray/White	6/cs.



C. PRIME SOURCE® COUNTERMOUNT SOAP DISPENSER PRIME SOURCE®

Countermount soap dispenser.

75004250	75004250	1000 mL	1/ea.
----------	----------	---------	-------



D. PRIME SOURCE® FOAMING SOAP DISPENSERS PRIME SOURCE®

Wall mounted foaming soap dispensers.

750042451	75004245	1250 mL, Black (w/Logo)	1/ea.
75004245	75004245	1250 mL, Black (w/Logo)	6/cs.
750042591	75004259	1250 mL, Black (no Logo)	1/ea.
75004259	75004259	1250 mL, Black (no Logo)	6/cs.
750042421	75004242	1250 mL, Gray	1/ea.
75004242	75004242	1250 mL, Gray	6/cs.
75004249	75004249	2000 mL, Black	6/cs.
750042431	75004243	2000 mL, Gray	1/ea.
75004243	75004243	2000 mL, Gray	6/cs.



E. PRIME SOURCE® LTX-7™ SOAP DISPENSER PRIME SOURCE®

Compact 700mL dispenser is ideal for tight spaces. Lifetime Performance Guarantee; including batteries. "Gojo Smart Electronics" technology minimizes energy use per actuation, eliminating need to change batteries over the life of the system in most installations. Large sight window, skylight and clear refill bottles make it easy to check fill status. "Controlled Collapse" refills hold their shape as they empty for a more attractive appearance. Easily converts to locking dispenser. Fully ADA compliant.

75000148	75000148	700 mL, Black/Black	4/cs.
75000147	75000147	700 mL, Gray/White	4/cs.



F. PRIME SOURCE® LTX-12™ SOAP DISPENSER PRIME SOURCE®

High capacity 1200mL dispensers ideal for high traffic areas. Lifetime Performance Guarantee; including batteries. "Gojo Smart Electronics" technology minimizes energy use per actuation, eliminating need to change batteries over the life of the system in most installations. Large sight window, skylight and clear refill bottles make it easy to check fill status. "Controlled Collapse" refills hold their shape as they empty for a more attractive appearance. Easily converts to locking dispenser. Fully ADA compliant.

75000153	75000153	1200 mL Black/Black	4/cs.
75000152	75000152	1200 mL, Gray/White	4/cs.



G. PRIME SOURCE® SOAP DISPENSERS PRIME SOURCE®

Wall mounted bag-in-the-box system soap dispensers.

750042331	75004233	800mL, Black	1/ea.
75004233	75004233	800mL, Black	12/cs.
750042101	75004210	800mL, White	1/ea.
75004210	75004210	800mL, White	12/cs.





Soap Dispensers



A. PRIME SOURCE® SOAP DISPENSERS PRIME SOURCE®

Wall mounted soap dispenser systems.

75004234	75004234	1000 mL, Black	6/cs.
750042111	75004211	1000 mL, Gray	1/ea.
75004211	75004211	1000 mL, Gray	6/cs.
75004235	75004235	2000 mL, Black	8/cs.
750042121	75004212	2000 mL, Gray	1/ea.
75004212	75004212	2000 mL, Gray	8/cs.



B. PRIME SOURCE® TWIN SOAP DISPENSER PRIME SOURCE®

Twin wall mounted soap dispenser system.

75004230	75004230	1000 mL, Gray	6/cs.
----------	----------	---------------	-------



C. PRIME SOURCE® TOUCH-FREE FOAMING SOAP DISPENSER PRIME SOURCE®

Wall mounted, touch-free, foaming soap dispenser system.

750042131	75004213	1200 mL, Gray	1/ea.
75004213	75004213	1200 mL, Gray	12/ea.



D. PRIME SOURCE® TOUCH-FREE SOAP DISPENSERS PRIME SOURCE®

Touch-free soap dispenser systems.

750042541	75004254	1000 mL, Black	1/ea.
75004254	75004254	1000 mL, Black	12/ea.
75004248	75004248	1000 mL, Gray	1/ea.



E. PRIME SOURCE® TOUCH-FREE COUNTERMOUNT SOAP DISPENSERS PRIME SOURCE®

Touch-free countermount soap dispenser systems.

75004255	75004255	1000 mL	1/ea.
760042131	76004213	1000 mL, Gray	1/ea.



F. COLGATE-PALMOLIVE® PUSH STYLE SOAP DISPENSER COLGATE-PALMOLIVE®

Gentle push bar, designed to fit the curve of the human hand. Easily delivers the exact amount of soap needed. Compact cabinet design provides a sleek, unobtrusive look.

11901944	01946	800 mL, Gray	12/cs.
----------	-------	--------------	--------



G. DIAL® LIQUID SOAP DISPENSER DIAL®

Translucent cover allows for continuous soap viewing. Large push button is intuitive and ADA compliant. Bottle is induction sealed for added safety. Seal is auto-punctured when installed in the dispenser. Eliminates mess. Adjustable dose rate (.76 g., 1.2 g., 1.54 g.) allows you to better control soap usage.

12803922	03922	1 L, Smoke	6/cs.
----------	-------	------------	-------



H. GOJO® 800 BAG-IN-BOX DISPENSERS GOJO®

Traditional bag-in-box dispensers. ADA compliant, one hand push operation reinforces mounting with each use. Portion control helps reduce waste.

354090321	903312	800 mL, Black	1/ea.
354000271	903412	800 mL, Ceramic White	1/ea.
35400027	903412	800 mL, Ceramic White	12/cs.



I. GOJO® FMX-12™ FOAMING SOAP DISPENSER GOJO®

Great for locations where a smaller, traditional-sized dispenser is preferred. Delivers more than 1700 hand washes. Features skylight with an extra-large site window. ADA compliant, one hand push operation. Optional key lock included.

35405005	515506	1250 mL, Black	6/cs.
35405007	515006	1250 mL, Dove Gray	6/cs.

Soap Dispensers



A. GOJO® NXT® MAXIMUM CAPACITY™ SOAP DISPENSER GOJO

Holds twice the capacity of traditional dispensers of similar size. Helps ensure that employees, guests and tenants will not run out of product. Requires refilling half as often, saving time and money. Ideal for high-traffic, high-volume locations where frequent servicing is difficult or impractical. ADA compliant, one-hand push operation.

35400100 223008 2000 mL, Gray 8/cs.



B. GOJO® PRO 2000 BAG-IN-BOX DISPENSERS GOJO

Large display window shows the refill inside. ADA compliant, one-hand push operation. Sanitary Sealed™ refills are easy to load, store, and handle. Portion control helps reduce waste. Fresh dispensing valve with each refill. Constructed of high-impact ABS plastic.

35400021 720001 2000 mL, Black 1/ea.

35400091 720501 2000 mL, White 1/ea.



C. GOJO® TFX™ TOUCH-FREE DISPENSER GOJO

Touch-free, trouble-free hand hygiene. Skylight makes it easy to see when it's time to reload. Dispenser turns off automatically when opened. LED light shows when battery charge is low. 30,000 uses from three standard C-size alkaline batteries (included). Fully ADA compliant, UL/CE registered.

35402740 274012 1200 mL, Gray 12/cs.



D. PLACES™ BOTTLE HOLDER GOJO

Bracket is secured with adhesive strips that hold firmly to walls, doors, office equipment or other vertical surfaces. Removal is quick, easy and leaves no surface damage.

35409005 900512 Fits 12 oz. Bottles 12/cs.



E. PROVON® FMX-12™ FOAMING SOAP DISPENSER GOJO

Holds a 1250 mL sealed refill in a remarkably small footprint. Great for locations where a smaller, more traditional dispenser is preferred. Delivers more than 1,700 handwashes per refill. Features skylight with an extra-large site window. ADA compliant, one hand push operation. Optional key lock included.

35405009 516006 1250 mL, Dove Gray 6/cs.



F. PURELL® HAND SANITIZING WIPE STAND GOJO

A durable, free-standing unit that dispenses large, 1200 count refills of the Purell® Sanitizing Wipes in any high-traffic location. The station holds a total of 4800 wipes. Storage compartment that holds three refills in the back. Significantly reduces labor time. Controls inventory. Available with fully customizable signage.

354002261 9118DS2B 1/ea.



G. PURELL® HAND SANITIZING WIPES WALL BRACKET GOJO

Convenient, easy-to-install wall-mount bracket allows 175-count Purell® Sanitizing Wipes to be readily available. Perfect for high-traffic, high-volume applications. Wipes sold separately.

35409014 901401 Fits 175 ct. Canister 1/ea.



H. PURELL® NXT® SPACE SAVER™ SOAP DISPENSER GOJO

Much smaller footprint than traditional 800 mL dispensers, yet holds 1000 mL of product. Uses 1000 mL NXT® refills. Compact design integrates into most every décor. Fully ADA depth and push compliant. Ideal for applications with limited wall space or where décor or usage levels demand smaller dispensers.

354020061 212006 1000 mL, Dove Gray 1/ea.

35402006 212006 1000 mL, Dove Gray 6/cs.



I. PURELL® TFX™ TOUCH-FREE DISPENSER GOJO

Touch-free, trouble-free dispensing system. Automatically dispenses the perfect amount of Purell® foaming or gel needed for hand sanitizing in one shot. Nothing for the user to touch. Dispenser features a skylight with an extra-large site window that makes it easy to see when it's time to reload. Fully ADA compliant.

35402002 272012 1200 mL, Dove Gray 12/cs.



J. PURELL® RETRACTABLE CLIP GOJO

Convenient clasp attaches easily to clothing.

35400824 960824 Holds a 2 oz. Pump or Squeeze Bottle 24/cs.



Soap Dispensers/Hotel Amenities



SOAPS



A. PURELL® SANITIZING STATION GOJO

Ideal for high-traffic areas used by patrons and employees. Ready access encourages hand hygiene. Practical built-in shield keeps surrounding area clean. Easy to assemble. For use with Purell® TFX™ Touch-Free Automatic Soap Dispenser (#2720-12, sold separately).

35400171 2423DS 5H 1/ea.

B. IN-SIGHT® ONEPAK SKIN CARE DISPENSER KIMBERLY-CLARK

This dispenser is curved and contemporary, creating the best impression for your restrooms.

15401180 91180 For 800 mL & 1000 mL Cartridges, Smoke Gray 1/ea.

C. IN-SIGHT® SERIES-I MINI 500 SKIN CARE DISPENSER KIMBERLY-CLARK

Sleek, contemporary design made of high impact plastic. Front cover pivots forward and pump loads in front for easy loading. Push lever for easy one-hand operation. Delivers a metered amount of soap through a one-way peristaltic pump, minimizing contact between product and outside environment. Features a keyless lock system.

15402625 92190 500 mL, Black 1/ea.



D. SURETOUCH® REFLECTIONS SOAP DISPENSER KIMBERLY-CLARK

Counter mounted soap dispenser. Engineered to eliminate common soap dispensing problems like clogs and leaks. Polished chrome finish.

15401934 91934 3⁹/₁₆" x 16²/₅" x 2¹/₂", Polished Chrome 1/ea.



E. WINDOWS® ONEPAK SKIN CARE DISPENSER KIMBERLY-CLARK

This dispenser is curved and contemporary, creating the best impression for your restrooms. Ideal for 800 mL and 1000 mL cartridges.

15401086 91182 For 800 mL & 1000 mL Cartridges, White 1/ea.



F. CLASSIC SOAP DISPENSERS SAN JAMAR

Classic bulk soap dispensers designed to be durable and accommodate a wide variety of liquid and lotion soaps (except pumice). Large push bar allows for easy dispensing.

62571030 S30TBK 30 oz., Black Pearl 6/cs.
62574600 S46TBK 46 oz., Black Pearl 1/ea.



G. WALL MOUNT HAND CARE SYSTEM ZEP

Industrial grade dispensing system that offers a sleek appearance with the durability of stainless steel internal components. For 1 gal. hand care products.

75070139 R09401 Dispenser 1/ea.



H. BRECK® CONDITIONING SHAMPOO DIAL

Newly enriched with aloe vera, nettle and sage, suitable for all hair types. Specially formulated for mildness, all Breck products are ideal for everyday use.

12809071 13190 3/4 oz. Luxor Bottle 288/cs.

HOTEL AMENITIES

All Purpose Floor Cleaners



ALL PURPOSE FLOOR CLEANERS

A. SPEEDEE MOP FLOOR CLEANER CARROLL

Liquid damp mop concentrate for use on high gloss floor finishes. No rinsing required when used as directed saving time and labor costs. Enhances floor appearance and prolongs life of finish. Pleasant sassafras fragrance.

30010479 10028 1 gal. 4/cs.
30010480 10019 5 gal. 1/ea.



B. SUPER SIX NEUTRAL NO-RINSE FLOOR DETERGENT CARROLL

Versatility, environmental safety and worker safety are built into this general purpose cleaner. May be used to effectively clean floors, counters and any other surfaces not harmed by water alone. Can be applied by trigger sprayer, mop or automatic floor scrubbing machines. This gentle but effective general purpose cleaner is ideal for the daily maintenance of schools, offices, institutions and other public facilities. Features "no-rinse" ease in most cleaning applications. Use to clean surfaces such as plastic, metal, laminates, glass, vinyl, walls and more.

30010139 12628 1 gal. 4/cs.



C. MR. CLEAN® FINISHED FLOOR CLEANER PROCTER & GAMBLE

Excellent cleaning and shine preservation for a wide range of finished floors including ceramic and vinyl tile, terrazzo, and varnished hardwood. Can be used as a versatile all purpose cleaner. Contains ingredients to cause the rapid collapse of its suds, making it an excellent choice for use in automatic floor scrubbing machines. Contains an optimized blend of nonionic and anionic surfactants designed to help maximize soil removal. Use it diluted (one fluid ounce per gallon) or for full-strength cleaning.

16902621 02621 1 gal. 3/cs.
16902474 84912474 1 gal., Closed Loop 3/cs.



D. SPIC AND SPAN® FLOOR CLEANER PROCTER & GAMBLE

Saves the time and effort of rinsing. Cuts through grease and tracked-in soils to minimize the need for multiple floor treatments.

16900130 02011 3 oz. Packets 45/cs.
16900129 02001 1 gal. 3/cs.



E. SPIC AND SPAN® FLOOR CLEANER W/BLEACH PROCTER & GAMBLE

Cuts tough greasy soil and bleaches out stains. Helps fight tough floor stains with the power of chlorine bleach. Portion packs help cut down on employee waste.

16902010 02010 2.2 oz. Packets 45/cs.

F. TIDE® ALL PURPOSE/FLOOR CLEANER PROCTER & GAMBLE

Heavy-duty floor and all purpose cleaner. Economical and versatile powdered cleaner cuts through tough grease and attacks tracked-in dirt. Cleans floors and walls (1/2-1 cup per 4 gallons), pots and pans (2 cups per sink), and laundry (1 cup per load). Can be used with chlorine bleach. Non-phosphate. Classified by UL to slip resistance 43R9.

16900913 08171 18 lb. 1/ea.
16902364 02364 36 lb. 1/ea.



G. MOP & GLO® MULTI-SURFACE FLOOR CLEANER RECKITT BENCKISER

Multi-surface floor cleaner with Shine Lock™ formula. Cleans your floors and leaves behind a long lasting shine in one quick and convenient step. Safe to use on tile, vinyl, hardwood, marble, linoleum, ceramic and no-wax floors.

58345432 75057 32 oz. 6/cs.
58344297 74297 64 oz. 6/cs.



All Purpose Floor Cleaners/Wood Floor Care/Dusting



HARD FLOOR CARE



A. AUTOMATIC FLOOR SCRUBBER SOLUTION ZEP

Heavy-duty, low foaming concentrated formula for auto scrubber and other industrial cleaning applications. Removes soils from smoke and fire damage. Ideal for use in pressure washers. Contains optical brighteners to brighten surfaces as it cleans.
75070042 R03024 1 gal. 4/cs.



B. BROAD SPECTRUM DISINFECTANT FLOOR CLEANER ZEP

Environmentally preferred neutral floor and hard surface cleaner disinfects floors and hard surfaces. Hospital grade disinfectant eliminates bacteria, fungi and viruses including HIV, MRSA, and Staph.
75070027 R02124 1 gal. 4/cs.
75070028 R02135 5 gal. 1/ea.



C. Z-VERDANT ALL PURPOSE CLEANER ZEP

Environmentally preferred, concentrated all purpose cleaner. May be used on any surface not harmed by water. Effective on a variety of soils such as wax buildup, fingerprints, and black marks on floors. May be used for most daily cleaning and maintenance operations. Contains no harmful solvents or harsh chemicals.
75070133 R08924 1 gal. 4/cs.
75070134 R08935 5 gal. 1/ea.



D. Z-VERDANT AUTO SCRUBBER SOLUTION ZEP

Environmentally preferred auto scrubber concentrate. Removes oil, grease, and dirt from floors and most other washable surfaces. Biodegradable, no petroleum, solvents or caustics.
75070129 R08724 1 gal. 4/cs.
75070130 R08735 5 gal. 1/ea.



E. MURPHY® OIL SOAP COLGATE-PALMOLIVE

Economical, natural cleaner that is ideal for mopping wood floors, paneling and other large wood surfaces. Naturally cleans finished and hard surfaces. EPA DfE approved formula.
11901101 01101 16 oz. 12/cs.
11902106 01106 32 oz., Concentrate 12/cs.
11900185 01185 32 oz., Trigger Sprayer 12/cs.
11900103 01103 1 gal., Concentrate 4/cs.



F. MOP & GLO® WOOD FLOOR CLEANER RECKITT BENCKISER

Quick, convenient one-step process cleans away the dirt and leaves a beautiful shine that provides long-lasting protection. Protects against wear and tear. Recommended for use on sealed wood floors.
58345065 75065 32 oz. 6/cs.



G. PRIME SOURCE® DUSTY MOP TREATMENT PRIME SOURCE®

Water-based formula leaves floor clean and shiny. No silicones or waxes that leave a slippery coating. Attracts dirt and dust like a magnet.
75004510 75004510 18 oz. 12/cs.



H. DUSTER PLUS® DUSTING SPRAY DIVERSEY

Dusts and leaves a shine on wood, resilient floors, even stainless steel. Works like a magnet to remove dust, oil-based and water-based smudges and stains. Can also be used as a dust mop treatment. Picks up dust rather than scattering it, so you dust less often. Fresh lemon fragrance. Contains no CFCs. Can be used on everything from furniture to floors, blinds to artificial plants, books to baseboards.
15200074 94752 17 oz. 6/cs.

WOOD FLOOR CARE

DUSTING

Concrete Cleaners/Tile & Stone Cleaners/Strippers



CONCRETE CLEANERS

A. ALL-OFF CONCRETE CLEANER/DEGREASER CARROLL

Removes difficult soils from concrete floors and driveways. Special color change agents identify area of product coverage. Orange color turns green when wet. Pine oil added to aid in emulsification and cleaning. Clean pine fragrance.

30010176 95010 50 lb. 1/ea.



B. AJAX EXPERT® OUTDOOR/CONCRETE CLEANER COLGATE-PALMOLIVE

Ready-to-use, d-limonene based cleaner for heavy-duty jobs. Removes stubborn grease and soils without harsh chemicals. Pleasant citrus fragrance. Can be used on concrete, asphalt, cement and ceramic tile.

11904166 04166 1 gal., Refill 4/cs.



C. HEAVY-DUTY POWDERED CONCRETE CLEANER ZEP

Fast-acting, powerful concrete cleaner changes color when wet to indicate concentration. Easy-to-use, biodegradable.

75070040 R02934 40 lb. 1/ea.
75070041 R02942 125 lb. 1/ea.



TILE & STONE CLEANERS

D. PRIME SOURCE® Q-T-C QUARRY TILE CLEANER PRIME SOURCE®

Rapidly removes grease and grime from quarry tile and grout surfaces. Improves slip resistance of floor.

75004493 75004493 1 gal. 4/cs.



E. QUARRY TILE CLEANER CARROLL

Removes slippery grease and soapy build up from quarry tile and concrete. Deep cleans by penetrating and reopening floor pores, water-based. Ideal for restaurants and institutional food service kitchens, concentrated. No fragrance added. USDA A3.

30010457 32528 1 gal. 4/cs.



F. SURE TRAC® ULTRA FLOOR CLEANER & TRACTION TREATMENT DIVERSEY

Penetrates deep into tile pores and grout to lift imbedded soils and grease, improving slip-resistance with repeated use. Also effective on concrete, ceramic tile, vinyl and resilient tile floors.

15200013 90228 1 gal. 2/cs.



FLOOR STRIPPERS

G. PRIME SOURCE® REVEAL NON-AMMONIA STRIPPER PRIME SOURCE®

Heavy-duty formula. Odor-free. Does not contain butyl cellulosol.

75004504 75004504 1 gal. 4/cs.
75004505 75004505 5 gal. 1/ea.
75004506 75004506 55 gal. 1/ea.



H. PRIME SOURCE® STRIP-EEZ BASEBOARD & EDGE CLEANER PRIME SOURCE®

Strong, foaming cleaner. Emulsifies heavy wax build-up. Clings to vertical surfaces.

75004476 75004476 19 oz. 12/cs.



HARD FLOOR CARE

Floor Strippers/Neutral Floor Cleaners



HARD FLOOR CARE



A. PRIME SOURCE® SUPER STRIP-EEZ LIQUIFYING STRIPPER PRIME SOURCE®

No-rinse, solvent-based stripper that quickly penetrates and liquifies multiple layers of floor finish for complete removal.

75004477 75004477 1 gal. 4/cs.
75004478 75004478 5 gal. 1/ea.



B. ENVIROPATROL® WAX & FINISH REMOVER CARROLL

When used as directed, this product is a high performance, ultra low odor, non-toxic, non-corrosive, butyl-free, ammonia-free wax and finish remover. Specially designed to remove conventional zinc crosslinked finishes as well as environmentally preferable zinc-free floor finishes like EnviroPatrol® Metal Free Floor Finish. A highly concentrated rapid response stripper that dissolves multiple coats of finish without the strong and unpleasant odor associated with conventional strippers. Rinses quickly without leaving residual alkali to interfere with finish application. Dilute one part to six parts of cold water for most applications. This product has been 3rd party certified by Green Seal™ according to GS-40 Environmental Standard and is recognized by the U.S. Environmental Protection Agency Design for the Environment (DfE) Formulator Initiative. Cold water effective.

30011276 35028 1 gal. 4/cs.
30011274 35019 5 gal. 1/ea.



C. SALVO NON-AMMONIATED FLOOR STRIPPER CARROLL

Non-ammoniated, concentrated, re-liquefying stripper. Quickly and completely removes floor finish with little or no agitation. Can be used as a mop-on, pick up stripper. Water-based solvent system.

30011028 31028 1 gal. 4/cs.



D. SUPER STRIP PLUS EMULSIFYING STRIPPER CARROLL

Non-ammoniated, very aggressive floor finish emulsifier. Completes job with first application saving time and labor costs. Effective on heavily burnished finishes and chemical resistant sealers. Water-based solvent system.

30010472 30828 1 gal. 4/cs.



E. FLOOR SCIENCE® FLOOR STRIPPER DIVERSEY

Strips floors in minimal time, provides uniform wetting, super penetration and total emulsification action. For tough jobs on burnished or spray buffed finishes. Extra heavy-duty, non-ammonia stripper penetrates fast to remove finish and dissolve tough build-ups. Low foaming, pleasant scent. Universal application; can be used on resilient and non-resilient floors (do not use on wood, cork and painted surfaces).

15200099 5116002 1 gal. 4/cs.



F. Z-TREAD HEAVY-DUTY FLOOR STRIPPER ZEP

Heavy-duty, low-foaming stripper designed to quickly remove heavy floor finish buildup without the need for scrubbing. Will strip away multiple coats of finish. Free rinsing.

75070044 R03124 1 gal. 4/cs.

NEUTRAL FLOOR CLEANERS



G. PRIME SOURCE® NU-VIEW LOW FOAM NEUTRAL CLEANER PRIME SOURCE®

Low-foaming. Ideal for use in automatic scrubbers. Neutral pH formula. Film and residue-free cleaning.

75004004 75004004 1 gal. 4/cs.
75004005 75004005 5 gal. 1/ea.
75004006 75004006 55 gal. 1/ea.
76008500 76008500 3.78 L 4/cs.
76008501 76008501 18.9 L 1/ea.

Neutral Floor Cleaners



A. ENVIROPATROL® NEUTRAL CLEANER CARROLL

Use as a highly efficient multi-use cleaner for floors, walls, woodwork and other washable surfaces where a neutral pH range is desirable. Quickly removes soil without dulling, damaging, etching, or harming floor finishes even when used for daily applications. Dilutes at 1 oz./gal. (1:128) for most applications. This product is recognized by the U.S. Environmental Protection Agency Design for the Environment (DfE) Formulator Initiative for its improved environmental and human health characteristics. Cold water effective.

30011272 12728 1 gal. 4/cs.



B. FORMULA 409® NEUTRAL FLOOR CLEANER CLOROX

Designed to clean a wide range of soils on a wide variety of floor surfaces. Loosens and removes tough soils, including foodservice kitchen soils. No rinsing required, saving time and labor. Leaves floors sparkling with no dulling film on the surface. UL classified for slip resistance. Fresh citrus scent. pH neutral and low foaming. Specially formulated for use with floor machines and automatic scrubbers.

38388738 14805 1 gal. 4/cs.



C. D.I.B.S.™ NEUTRALIZER/CONDITIONER DIVERSEY

Drop a water-soluble packet into a bucket of water and watch it surge into action, dissolve and disappear in a matter of seconds. What remains is a fully-charged solution, ready to clean in hot or cold, hard or soft water. Because you use one packet per application, it's simple to manage product distribution for use throughout your facility.

15207048 17048 1/2 oz. Packets, 90/Tub 180/cs.



D. EASY PAKS® NEUTRAL CLEANER DIVERSEY

Loosens and removes soil while protecting high gloss finishes. Leaves no dulling film, even without rinsing. For surfaces ranging from terrazzo, marble, slate and vinyl to asphalt, ceramic tile, quarry tile, terrazzo, marble, concrete, painted surfaces and vinyl.

15200107 90653 1/2 oz. Packets, 90/Tub 180/cs.



E. EASY PAKS® NEUTRALIZER/CONDITIONER DIVERSEY

Neutralizes alkaline residue after floor stripping and cleaning. Helps eliminate dulling, discoloring and hazing for a longer lasting, brighter finish. Conditions floors for better sealing. White in color with no fragrance added.

15200108 90685 1/2 oz. Packets, 90/Tub 180/cs.



F. STRIDE® CITRUS NEUTRAL CLEANER DIVERSEY

A neutral cleaner concentrate formulated for everyday cleaning of floors and other hard surfaces. This product does not dull floor finishes, and does not require rinsing to deliver labor savings.

15202613 5122613 1.4 L, SmartDose™ 2/cs.
15203904 03904 1 gal. 4/cs.



G. MASTERPIECE® NEUTRAL CLEANER RECKITT BENCKISER

Provides effective, low-foaming, rinse-free cleaning without stripping or reacting with the floor surface. Contains no alkalis, phosphates or ammonia. Can be used on conductive flooring, will not reduce floor conductive properties. Use in facilities where effective cleaning with mop-on or autoscrubber application is desirable. Economical, concentrated formula makes up to 64 gallons. Neutral pH at 1:64 dilution. Authorized under USDA Registration C-1 standards for use in federally inspected meat and poultry facilities.

58344454 74454 1 gal. 4/cs.



H. Z-TREAD NEUTRAL FLOOR CLEANER ZEP

Low-foam, general-purpose floor cleaner. May be mop applied or used in automatic floor scrubbers. Rinses easily. Neutral pH will not harm floor finishes.

75070050 R03424 1 gal. 4/cs.
75070051 R03435 5 gal. 1/ea.

HARD FLOOR CARE

Floor Finish



HARD FLOOR CARE



FLOOR FINISH

A. PRIME SOURCE® DAZZLE BRIGHT GLOSS FINISH PRIME SOURCE®

Flexible film. Fast drying and multi-speed buffable. Produces a "wet look" gloss.

75004501	75004501	1 gal.	4/cs.
75004502	75004502	5 gal.	1/ea.
76008525	76008525	3.78 L	4/cs.
76008526	76008526	18.9 L	1/ea.

B. PRIME SOURCE® GROUND LEVEL SEALER/FINISH PRIME SOURCE®

Fast drying. All acrylic formulation.

75004487	75004487	1 gal.	4/cs.
75004488	75004488	5 gal.	1/ea.
76008523	76008523	3.78 L	4/cs.
76008524	76008524	18.9 L	1/ea.

C. PRIME SOURCE® MIRAGE HIGH GLOSS FINISH PRIME SOURCE®

High solids with extra durability. Extra-hard wear surface. Produces an initial high gloss.

75004507	75004507	1 gal.	4/cs.
75004508	75004508	5 gal.	1/ea.
76008544	76008544	3.78 L	4/cs.
76008545	76008545	18.9 L	1/ea.

D. PRIME SOURCE® REFLECTIONS 250 HIGH SPEED FINISH PRIME SOURCE®

Designed for UHS floor maintenance. Produces a dazzling gloss. Extra wear and durability.

75004480	75004480	1 gal.	4/cs.
75004481	75004481	5 gal.	1/ea.
75004482	75004482	55 gal.	1/ea.

E. PRIME SOURCE® SHINE-ON UHS RESTORER/SPRAY BUFF PRIME SOURCE®

3-in-1 formulation that can be used as a spray buff, mop-on restorer, or through an auto scrubber. This cleaner/restorer enhances the gloss on any floor finish.

75004489	75004489	32 oz., Restorer	12/cs.
75004496	75004496	32 oz., Spray Buff	12/cs.
75004490	75004490	1 gal., Restorer	4/cs.
76008519	76008519	3.78 L, Restorer	4/cs.

F. PRIME SOURCE® VISIONS WET LOOK FINISH PRIME SOURCE®

Flexible film. Fast drying and multi-speed buffable. Produces a "wet look" gloss.

75004483	75004483	1 gal.	4/cs.
75004484	75004484	5 gal.	1/ea.
76008517	76008517	3.78 L	4/cs.
76008518	76008518	18.9 L	1/ea.

G. DOWN UNDER ALL PURPOSE SEALER CARROLL

High-gloss, water emulsion seal/undercoat designed with durable, protective properties for resilient and non-resilient floors, except wood.

30010089	65828	1 gal.	4/cs.
----------	-------	--------	-------

H. ENVIROPATROL® METAL FREE FLOOR FINISH CARROLL

This state-of-the-art finish has exceptional gloss, durability, soil resistance, detergent resistance, recoatability, removability, and slip resistance. Versatile and can be maintained using traditional maintenance procedures including scrub/recoat or high speed burnishing. Third party certified by Green Seal™ according to GS-40 Environmental Standard and is recognized by the U.S. Environmental Protection Agency Design for the Environment (DFE) Formulator Initiative. Cold water effective.

30016728	66728	1 gal.	4/cs.
30010667	66719	5 gal.	1/ea.
30011275	ENVIROFIN5G	5 gal.	1/ea.

Floor Finish/Ice Melt



A. LEVEL BEST® HIGH SOLIDS FLOOR POLISH CARROLL

Ultra high solids; excellent gloss, slip resistance and durability. Flexible metal cross-linked finish. Single coat acts as sealer and finish, reducing labor costs. Non-yellowing, non-powdering; regular or high speed burnishing.

30010084 69028 1 gal. 4/cs.



B. POLARIS ULTRA PREMIUM UHS FLOOR FINISH CARROLL

Ultra high solids formula requires fewer coats saving time and labor. Designed for high traffic areas with excellent gloss and scuff resistance. Extremely durable which extends recoating and strip-out cycles, reducing labor costs. UHS formulated for compatibility with UHS propane, battery, and electric equipment. SPT - synergistic polymer technology formulated for durability and "wet look" gloss.

30010213 62328 1 gal. 4/cs.

30010214 62319 5 gal. 1/ea.



C. PRO-TRACT SEALER/FINISH CARROLL

Designed for use in high traffic areas. Combines brilliant high gloss, outstanding durability and excellent slip resistance. Unique polymer system is easy to use and provides even application. Use with any speed buffer or burnisher (including propane).

30010079 67728 1 gal. 4/cs.



D. TEN® FLOOR FINISH CARROLL

Innovative terpolymer technology offers performance value. Designed to protect, preserve, and enhance flooring. Easy to apply, repair and recoat. High initial gloss is also long lasting and buffable.

30010081 68028 1 gal. 4/cs.



E. FLOOR SCIENCE® FINISH DIVERSEY

Synthetic polymer floor finish/sealer that produces a "wet look" high gloss. For conventional, high speed and ultra high speed floor machines. Dries fast, no sealer required. For resilient and non-resilient floors. Universal applications—can be used on vinyl, vinyl composition, vinyl asbestos, asphalt tile and rubber, as well as terrazzo, marble, slate, unglazed ceramic and quarry tile, brick and granite.

15200098 98391 1 gal. 4/cs.

15208391 98390 5 gal. BIB 1/ea.



F. FLOOR SCIENCE® SPRAY BUFF DIVERSEY

Cleans and restores the high gloss "wet look" of Floor Science® Finish (sold separately). Premium performance—cleans, shines, removes heel marks, scratches, tar and ingrained dirt. Leaves a brilliant shine without build-up or discoloration. Effective with low speed or high speed floor machines. Works in minimal time.

15206896 96896 1 gal. 4/cs.



G. MASTERPIECE® HIGH GLOSS FLOOR FINISH RECKITT BENCKISER

High gloss floor finish is repairable without the need for a restorer, just clean and burnish or recoat and burnish. Use in facilities that demand a high-profile, "wet look" shine.

58340009 03905 5 gal. 1/ea.



H. Z-TREAD BURNISH RESTORER ZEP

Environmentally preferred, concentrated floor gloss restorer cleans and prepares floor for burnishing in one easy step. Eliminates need for frequent stripping and refinishing.

75070058 R03835 5 gal. 1/ea.



ICE MELT

I. ROAD RUNNER ICE MELT SCOTWOOD INDUSTRIES

A blend that contains calcium and magnesium chloride pellets. Recognized as one of the most effective blends on the market. Begins melting immediately upon impact, generates melting heat fast. Effectively melts ice down to -15°F. Needs fewer applications than rock salt. Safe on streets, driveways, sidewalks, steps and the environment when applied correctly. Does not track. Odorless and colorless.

16770014 RR50 50 lb. Bag 1/ea.

16770013 RR50BOX 50 lb. Box 1/ea.

16770008 RR50PAIL 50 lb. Pail 1/ea.



HARD FLOOR CARE

Carpet Cleaners



CARPET CLEANERS

A. PRIME SOURCE® RENEW HEAVY-DUTY EXTRACTION CLEANER PRIME SOURCE®

Neutral pH base. Safe for fifth generation carpeting. Clean fresh scent. Low foaming; saves time and money.
75004087 75004087 1 gal. 4/cs.



B. PRIME SOURCE® ROYAL ROTARY DRY FOAM SHAMPOO PRIME SOURCE®

Neutral pH base. Safe for fifth generation carpeting. Clean fresh scent. Prevents resoiling; carpet retains showcase appearance.
75004085 75004085 1 gal. 4/cs.



C. PRIME SOURCE® SPIN-OFF BONNET & TRAFFIC LANE CLEANER PRIME SOURCE®

Neutral pH base; safe for fifth generation carpeting. Clean fresh scent. Dries rapidly; cleaned areas may be reopened to traffic with little downtime.
75004086 75004086 1 gal. 4/cs.



D. QUICK DRAW® STEAM MACHINE SHAMPOO CARROLL

Low foaming, convenient to use steam-type extraction shampoo. Optical brighteners and soil retardants added. Penetrates and suspends soils for easy removal. Clean lemon fragrance.
30010122 23028 1 gal. 4/cs.



E. PROFESSIONAL RESOLVE® CARPET EXTRACTION CLEANER RECKITT BENCKISER

One product, one dilution for three cleaning uses: carpet extraction cleaner, traffic lane cleaner and pretreatment spray. Perfect for a scheduled maintenance plan for surface and deep, down-to-the-backing cleaning. Low foaming, cleans and deodorizes. Contains strong grease-cutting agents. Economical, concentrated formula makes up to 64 gallons (1:64).
58347161 97161 1 gal. 4/cs.



F. SIMPLE GREEN® CLEAN BUILDING™ CARPET CLEANER CONCENTRATE SIMPLE GREEN

Formulated especially for cleaning carpets and rugs. Green Seal™ Certified and also certified by the Carpet and Rug Institute. Carpet warranties that call for the use of only CRI-approved products will not be jeopardized. No added fragrance or volatile organic ingredients. Non-toxic, biodegradable, non-caustic, and non-flammable. Makes 22 gallons of ready-to-use cleaner.
73431301 11301 1 gal. 2/cs.



G. CARPET PRE-TREATMENT SOLUTION ZEP

Ready-to-use, water-based carpet cleaning formula penetrates carpet soils and separates them from fibers. Low foam formula will not disrupt extraction carpet cleaning. Safe on stain resistant treated carpets.
75070017 R01201 1 qt. 12/cs.
75070018 R01235 5 gal. 1/ea.



H. HIGH FOAM CARPET SHAMPOO ZEP

Environmentally preferred carpet shampoo designed for deep cleaning. "Dry" foam allows for rapid drying and a quicker return to use. Inhibits surface resoiling and leaves behind a fresh fragrance. Safe on stain-resistant treated carpets.
75070015 R01124 1 gal. 4/cs.
75070016 R01135 5 gal. 1/ea.



I. LEMONGRASS CARPET EXTRACTION SOLUTION ZEP

Environmentally preferred carpet cleaner with light lemongrass fragrance. Designed for hot water extraction or bonnet method carpet cleaning. Safe on stain-resistant treated carpets. Friable surfactants dry to a powder which are easily vacuumed up, leaving no residue behind. Concentrated formula.
75070009 R00624 1 gal. 4/cs.
75070010 R00635 5 gal. 1/ea.



CARPET CARE

Stain Removers

STAIN REMOVERS

CARPET CARE



A. PRIME SOURCE® NATURE'S CLEANER DEODORIZER/SPOTTER/DIGESTER PRIME SOURCE®

Multi-purpose. Blended with multiple, non-pathogenic bacterial strains. Contains over 100 billion bacteria per gallon. Destroys uric acid and odor-causing bacteria.

75004072	75004072	1 qt.	12/cs.
75004075	75004075	1 gal.	4/cs.
75004076	75004076	55 gal.	1/ea.



B. PRIME SOURCE® SPOT UP CARPET SPOT REMOVER PRIME SOURCE®

Neutral pH base. Safe for fifth generation carpeting. Clean fresh scent. Penetrates oil, grease and dry soil, then releases onto the brush or cloth.

75004083	75004083	1 qt.	12/cs.
75004084	75004084	1 gal.	4/cs.



C. PRIME SOURCE® STAINOUT FOAMING CARPET CLEANER PRIME SOURCE®

Water-based formula. Safe for carpets and upholstery. For tough stains and small area cleaning.

75004081	75004081	18 oz.	12/cs.
----------	----------	--------	--------



D. CARPET SCIENCE® SPOT & STAIN REMOVER DIVERSEY

Emulsion formula breaks up and lifts out most oil and water-based soils. Removes tough motor oil, margarine, lipstick, fruit juices, coffee, wine, tea, spaghetti sauce and chocolate stains. Leaves no sticky residue, will not attract soils. Contains DuPont Zelan® stain blocker.

15200182	94350	32 oz.	6/cs.
----------	-------	--------	-------



E. CITRUS EXPRESS™ GEL DIVERSEY

Simple-to-use, versatile, gelled solvent spotter. This unique solvent and detergent formula easily removes gum, adhesives, tar, oils, grease, ink and marker. Milky white with a citrus scent.

15202523	5002523	32 oz.	6/cs.
----------	---------	--------	-------



F. GENERAL PURPOSE SPOTTER DIVERSEY

All purpose water-based spotter. Low residue formula will not resoil your carpet. Gets out tough stains...even the old ones. Safe on all carpets including wool.

15204192	4192	32 oz.	6/cs.
----------	------	--------	-------



G. PROFESSIONAL RESOLVE® SPOT & STAIN CARPET CLEANER RECKITT BENCKISER

This product can be used as a traffic lane cleaner and pretreatment spray and is effective against most food and grease-based stains.

58347402	97402	32 oz.	12/cs.
----------	-------	--------	--------



H. RESOLVE® DUAL POWER SPOT CARPET CLEANER RECKITT BENCKISER

With Oxi Action stain fighters. Unites two liquid stain removal agents; a stain fighter and an oxygen activator that activates when combined and fizz and bubble deep into the stain. It begins to breakdown and dissolve a wide variety of tough stains.

58347873	77873	22 oz.	12/cs.
----------	-------	--------	--------



I. RESOLVE® HIGH TRAFFIC™ FOAM CARPET CLEANER RECKITT BENCKISER

With Stain Repel™ protector that has a unique cleaning and protective formula to make carpet cleaning easier.

58340706	00706	22 oz.	12/cs.
----------	-------	--------	--------



J. RESOLVE® SPOT MAGIC® STAIN CLEANER RECKITT BENCKISER

Powerful, superior formula dissolves tough stains like greasy food, motor oil, red wine, grape juice, ink and coffee instantly without scrubbing.

58345892	75892	14 oz.	12/cs.
----------	-------	--------	--------

Stain Removers/Defoamers



A. SIMPLE GREEN® CARPET CLEANER SIMPLE GREEN

Professional-strength formula deodorizes as it deep-cleans and safely removes tough stains such as: motor oil, grease, coffee, wine, chocolate, blood, lipstick, and much more. Non-toxic, non-allergenic, and biodegradable. Contains a special protection agent that helps maintain the stain resistance already found in most carpets, rugs and upholstery. Brightens without bleach, is clean rinsing and has no added color of petroleum distillates. Versatile, concentrated formula can be custom diluted to safely clean stains or for use in hot water extraction and steam carpet machines.

73437024 57024 22 oz. 12/cs.



B. BIOENZYMATIC CARPET SPOTTER ZEP

Environmentally preferred, biologically-based carpet spotter removes tough stains from carpets through combined detergent and enzymatic action.

75070014 R01001 32 oz. 12/cs.



C. PRE-MOISTENED UPHOLSTERY/CARPET SPOTTER TOWELS ZEP

Heavy-duty spotter towels designed to loosen and pick up soils of all types. Instantly remove stains from upholstery and carpet. Tough fabric construction will not tear or rip on carpet.

75070135 R09001 72 ct. 6/cs.

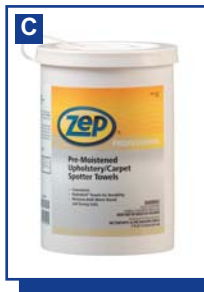

DEFOAMERS

D. PRIME SOURCE® DEFOAM DEFOAMER PRIME SOURCE®

Eliminates troublesome foam in the recovery system of carpet extractors. Saves labor and time. Economical to use.

75004088 75004088 1 gal. 4/cs.



E. BUBBLE BUSTER® DEFOAMER CARROLL

Quickly breaks down foam and prevents foam buildup. For use in all steam type carpet cleaning machines and wet-vacs. Use to greatly reduce time and labor needed to complete task. Highly concentrated, white opaque color; no fragrance added.

30010126 46028 1 gal. 4/cs.



F. LIQUID DEFOAMER DIVERSEY

Eliminates frequent emptying on foam filled recovery tanks. Works in hoses, tools and recovery tanks. pH neutral and phosphorous free.

15202620 5002620 32 oz., RTU 6/cs.



Standard Toilet Tissue



STANDARD TOILET TISSUE

A. TOILET TISSUE PRIME SOURCE®

Green Source™

100% recycled. Chlorine-free. EcoLogo® Certified. Trilingual packaging (English, Spanish, French).

75009500 75009500 400 ct., 4" x 3³/₄", White, 2-Ply 96/cs.

Prime Source® Controlled Use

High quality, value priced tissue ideal for all public environments.

75004344 75004344 1232 ct., 3⁷/₈" x 4", White, 1-Ply 48/cs.

75004343 75004343 616 ct., 3⁷/₈" x 4", White, 2-Ply 48/cs.

75004346 75004346 865 ct., 3⁷/₈" x 4", White, 2-Ply 36/cs.

Prime Source® Universal

High quality, value priced tissue ideal for all public environments.

75004360 75004360 500 ct., 4¹/₂" x 3³/₅", White, 2-Ply 96/cs.

75004353 75004353 500 ct., 4¹/₂" x 3³/₅", White, 2-Ply 48/cs.

75004354 75004354 500 ct., 4³/₈" x 3³/₄", White, 2-Ply 96/cs.

75004355 75004355 500 ct., 4³/₈" x 4¹/₂", White, 2-Ply 96/cs.

75004354 75004355 500 ct., 4³/₈" x 4¹/₂", White, 2-Ply 96/cs.



B. HI-VALU TOILET TISSUE HI-VALU

Standard roll tissue is high quality and value priced. Ideal for all public environments.

73004353 73004353 1000 ct., 4¹/₂" x 3¹/₂", White, 1-Ply 96/cs.

73004364 73004364 500 ct., 4¹/₈" x 3¹/₇", White, 2-Ply 96/cs.

73004365 73004365 500 ct., 4¹/₂" x 3¹/₉", White, 2-Ply 96/cs.

73004354 73004354 500 ct., 4¹/₂" x 3¹/₂", White, 2-Ply 96/cs.



C. TOILET TISSUE GEORGIA-PACIFIC

Angel Soft® PS

A premium two-ply bathroom tissue that delivers the appearance and softness of at-home tissue. A recognized brand by 96% of consumers. Safe for all standard sewer and septic systems. Attractive emboss makes a positive impression with your customers.

13700150 16880 450 ct., 4" x 4¹/₂₀", White, 2-Ply 80/cs.

13706580 16580 450 ct., 4¹/₂" x 4", White, 2-Ply 80/cs.

Angel Soft® PS Ultra™ Premium Embossed

Offers premium quality and softness for at-home comfort away-from-home. This soft, absorbent, two-ply embossed bath tissue brings an added touch of luxury to our premium line and provides hospitality managers with an effortless option that gives guests the special treatment today's travelers expect. Your guests will be truly touched when they discover Angel Soft ps Ultra™ bath tissue among their amenities. Perfect for use in luxury hotels, fine dining, top casinos and executive offices. Show guests that you care to use the very best.

13706560 16560 400 ct., 4¹/₂" x 4¹/₁₆", White, 2-Ply 60/cs.

Compact® Coreless

Coreless bath tissue rolls provide up to three times the sheet count of standard two-ply tissue. Fits Compact® high capacity tissue dispensers.

13709375 19375 1000 ct., 4" x 4¹/₂", White, 2-Ply 36/cs.

13709378 19378 1500 ct., 4" x 4¹/₂", White, 2-Ply 18/cs.

Cormatic®

Fits Cormatic® and Ultima® tissue systems. Facial quality shell-embossed two-ply bath tissue offers premium softness and absorption.

13701583 2520 1000 ct., 4" x 4", White, 2-Ply 36000/cs.

Envision®

Value-oriented multilayer bath tissue for environmentally concerned customers.

13704580 14580 1210 ct., 4¹/₂" x 4", White, 1-Ply 80/cs.

13709880 19880 550 ct., 4¹/₂" x 4", White, 2-Ply 80/cs.

Preference®

EPA compliant for minimum post-consumer fiber content. Mid-range quality, embossed two-ply bathroom tissue.

13708280 1828001 550 ct., 4" x 4", White, 2-Ply 80/cs.

Rollmastr®

Economy bath tissue is designed to reduce maintenance time, minimize outages and reduce waste. Refill for Rollmastr® high capacity tissue system.

13709020 19020 1540 ct., 4" x 4", White, 1-Ply 48/cs.

13709027 19027 770 ct., 4" x 4", White, 2-Ply 48/cs.



PAPER PRODUCTS



Standard Toilet Tissue

PAPER PRODUCTS



A. ROLL TISSUE

KIMBERLY-CLARK

Kleenex® Cottonelle® Coreless

Two-ply bath tissue that delivers the soft, plush quality of home without the core. Fits dispensers 09007 and 09606.

15407001 07001 800 ct., 4" x 4²/₅", White, 2-Ply 36/cs.

Kleenex® Cottonelle®

Kleenex® bathroom tissue is now made with 25% recycled fiber and 20% post consumer waste content. Meets EPA minimum standards for post-consumer waste content in bathroom tissue.

15400315 54080 400 ct., 4" x 4", White, 2-Ply 48/cs.

15403136 03135 400 ct., 4¹/₂" x 4", White, 2-Ply 20/cs.

15407713 07713 400 ct., 4¹/₂" x 4²/₅", White, 2-Ply 96/cs.

15403137 13135 506 ct., 4" x 4", White, 2-Ply 20/cs.

15407715 17713 506 ct., 4" x 4", White, 2-Ply 60/cs.

15408336 88336 506 ct., 4¹/₂" x 4", White, 2-Ply 40/cs.

Scott®

Extra soft bath tissue.

15401117 44132 469 ct., 4¹/₅" x 4", White, 1-Ply 48/cs.

An excellent balance of strength, absorbency and economy. Meets EPA guidelines for post-consumer waste.

15405103 05102 1210 ct., 4¹/₂" x 4", White, 1-Ply 80/cs.

15403607 03607 500 ct., 4¹/₂" x 4¹/₂", White, 2-Ply 24/cs.

15401360 13607 605 ct., 4¹/₁₀" x 4", White, 2-Ply 20/cs.

15406050 0446050 605 ct., 4¹/₂" x 4", White, 2-Ply 80/cs.

Scott® 100% RF

Made with 100% recycled fiber. Meets EPA standards for 40% minimum post-consumer waste content. Green Seal™ Certified.

15403217 13217 550 ct., 4" x 4", 2-Ply 80/cs.

15406446 64460 605 ct., 4¹/₂" x 4", White, 2-Ply 80/cs.

Scott® Coreless

A high capacity, easy maintenance system which results in less run-outs and lower maintenance costs. Meets EPA guidelines for post consumer waste - minimum of 20%. Elemental chlorine-free (ECF) bleaching. Waste reduction with 100% elimination of core waste. 5¹/₂" roll diameter.

15404007 04007 1000 ct., 4" x 4²/₅", White, 2-ply 36/cs.

B. TOILET TISSUE

MARCAL PAPER MILLS

Marcal Pro Fluff®

Soft and absorbent combined with economy, offering exceptional value. Individually wrapped rolls. 100% recycled. Whitened without chlorine bleaching. Hypoallergenic. Virtually lint-free. No dye or fragrance.

15705001 5001 504 ct., 4¹/₃" x 3²/₃", White, 2-Ply, Poly Bundle 48/cs.

Small Steps® At Home & In The Office

At home quality and coordinated packaging, perfect for any application. Individually wrapped rolls. 100% recycled. Whitened without chlorine bleaching. Hypoallergenic. Virtually lint-free. No dye or fragrance.

15706466 16466 168 ct., 4¹/₃" x 3²/₃", White, 2-Ply, Poly Bundle 96/cs.

Small Steps® 100% Premium Recycled

Made with a minimum of 60% post consumer content. Meets or exceeds EPA guidelines for post consumer content. Septic safe. Great for small to medium offices. Soft and strong. Whitened without chlorine bleaching. No dye or fragrance added. Virtually lint-free.

15706080 6079 336 ct., 4¹/₃" x 3²/₃", White, 2-Ply, Corrugated Carton 48/cs.

Marcal Pro Snow Lily®

Packaged in convenient polycase bundles that are not only strong, they are easier to handle, unload and store. 100% recycled. Whitened without chlorine bleaching. Hypoallergenic. Virtually lint-free. No dye or fragrance.

15704072 4072 336 ct., 4¹/₄" x 4¹/₂", White, 2-Ply, Poly Bundle 48/cs.

Marcal Pro Sunrise®

Packaged in convenient polycase bundles that are not only strong, they are easier to handle, unload and store. 100% recycled. Whitened without chlorine bleaching. Hypoallergenic. Virtually lint-free. No dye or fragrance.

15703001 3001 240 ct., 4¹/₃" x 3²/₃", White, 2-Ply, Poly Bundle 48/cs.



Standard Toilet Tissue



A. BATHROOM TISSUE PROCTER & GAMBLE

Charmin® Basic Big Roll

A great balance of softness and strength. One Charmin® Basic Big Roll equals two regular rolls of Charmin® toilet tissue, so you save time and money. Unscented.

16900082	23458	308 ct., 4 ¹ / ₈ " x 4 ⁷ / ₁₆ ", 1-Ply, 6-Pack	48/cs.
16900268	50908	264 ct., 4 ¹ / ₂ " x 4 ¹ / ₂ ", 1-Ply, 6-Pack	48/cs.

Charmin® Ultra Strong

What do you get when you combine Charmin softness with a DiamondWeave™ texture? A dependable clean for your whole family. Charmin Ultra Strong toilet paper is more durable than the ultra rippled brand, so you can count on a clean with fewer pieces left behind.

16900089	23992	4 Regular Rolls	96/cs.
16900083	23998	4 Big Rolls = 8 Regular Rolls	40/cs.
16900151	29685	4 Big Rolls = 8 Regular Rolls, 176 ct.	40/cs.
16900154	23993	24 Regular Rolls, 88 ct.	24/cs.



B. TOILET TISSUE ROSES SOUTHWEST PAPER

Bathroom tissue.

Azalea

59341197	91197	1000 ct., 4 ¹ / ₂ " x 3 ³ / ₄ ", White, 1-Ply	96/cs.
59342196	42196	500 ct., 4 ¹ / ₂ " x 3 ³ / ₄ ", Azalea, 2-Ply	96/cs.

Petite

59344215	42156	500 ct., 4 ¹ / ₈ " x 3 ³ / ₄ ", Rose, 2-Ply	96/cs.
----------	-------	---	--------

Roses

59342136	42136	500 ct., 4 ¹ / ₂ " x 4 ¹ / ₂ ", White, 2-Ply	96/cs.
----------	-------	--	--------



C. BATH TISSUE SCA TISSUE

Tork® Advanced

Soft and absorbent two-ply bath tissue tells the user that you care about their comfort. Handsomely embossed, it enhances bulk and softness. Each roll is elegantly wrapped ensuring sanitary protection. Easy start tail seal prevents waste. Rapid break-up capabilities are ideal for all plumbing systems. Made from 100% recycled fibers for an environmental benefit. A positive image builder. EcoLogo® Certified. Replaces TM6120A.

14106121	TM6120S	500 ct., 4" x 3 ³ / ₄ ", 4 ⁷ / ₁₁ " Roll dia., White, 2-Ply	96/cs.
----------	---------	---	--------

Tork® Advanced High-Capacity

Provides hygienic dispensing while reducing waste and maintenance expense. Enhances the image of everyday washrooms. High capacity rolls eliminate service outages. Embossed rolls enhance bulk and softness. The banded rolls create less waste and source reduction. The easy start tail seal prevents waste. Rapid breakup; ideal for all plumbing systems. Made from 100% recycled fibers. Provides environmental benefits. A positive image builder.

14100086	110291A	2000 ct., 3 ⁹ / ₁₀ " x 62 ⁵ / ₈ ", White, T26 System, 1-Ply	36/cs.
14101293	110292A	1000 ct., 3 ¹⁵ / ₁₆ " x 3 ³ / ₄ ", 5 ² / ₅ " Roll dia., White, 2-Ply	36/cs.

Tork® Premium

An ultra soft, absorbent premium two-ply tissue service that delivers quality, value and performance. Elegant embossing enhances bulk and softness. Each roll is overall wrapped and that ensures sanitary protection. Easy start tail seal prevents waste. Rapid break-up capabilities are ideal for all plumbing systems. This product contains 20% Post Consumer fiber.

14106513	TM6511S	460 ct., 4" x 3 ³ / ₄ ", 4 ⁷ / ₁₁ " Roll dia., White, 2-Ply	96/cs.
----------	---------	---	--------

Tork® Universal

A soft, absorbent, economical two-ply tissue. Made from 100% recycled fibers a positive environmental image builder. EcoLogo® Certified.

14101615	TM1616S	500 ct., 4" x 3 ³ / ₄ " Sheets, White, 2-Ply	96/cs.
----------	---------	--	--------

A soft, absorbent, economical tissue that delivers quality, value and performance. Elegantly embossed. Each roll is overall wrapped. Easy start tail seal. Special tightly wound rolls. Rapid break-up capabilities. Made from 100% recycled fibers and a minimum of 20% Post Consumer fibers. EcoLogo® Certified. Green Seal™ Certified.

14101604	TM1604	750 ct., 3 ⁹ / ₁₀ " x 23 ⁴ / ₈ ", White, 2-Ply	48/cs.
----------	--------	--	--------

A soft, absorbent, economical tissue delivers quality, value and performance. Elegantly embossed. Each roll is overall wrapped. Easy start tail seal. Special tightly wound rolls. Rapid break-up capabilities. Made from 100% recycled fibers. EcoLogo® Certified.

14101637	TS1636S	1000 ct., 4" x 3 ³ / ₄ ", 4 ⁷ / ₂₀ " Roll dia., White, 1-Ply	96/cs.
14101640	TS1639S	1000 ct., 4" x 3 ³ / ₄ ", 4 ⁷ / ₂₀ " Roll dia., White, 1-Ply	48/cs.
14101616	TM1616	500 ct., 4 ¹ / ₈ " x 3 ³ / ₄ ", 4 ⁷ / ₁₁ " Roll dia., White, 2-Ply	96/cs.



PAPER PRODUCTS



Standard Toilet Tissue

PAPER PRODUCTS



A. TOILET TISSUE

SOFIDEL AMERICA

Confidence™

Offers the softness and quality of national branded products. Consistently bright, soft and absorbent. Ideal for hospitality venues, healthcare facilities and small businesses.

57370004 11500 500 ct., 4 1/2" x 4", White, 2-Ply 96/cs.

Heavenly Choice™

Standard bath tissue. Individually wrapped. Consistently bright, soft, and absorbent. Ideal for hospitality venues, healthcare facilities, and small businesses. Sheets sizes may vary by product.

57371241 11234 500 ct., 4 1/10" x 3 1/2", White, 1-Ply 96/cs.

Heavenly Choice™ Double Layer

Made from heavier-weight paper, this innovative one-ply tissue offers the luxurious look, strength and softness of a two-ply for a surprisingly competitive price. Double Layer enables you to offer a superior product to your customers while realizing significant cost savings.

Environmentally-friendly Double Layer takes less paper to produce and results in less waste being sent to landfills. High quality embossed, equivalent to national brands. Ideal for a wide range of low and high-traffic settings like business offices, healthcare and hospitality facilities. Made with fiber from sustainable sources.

57371634 11634 500 ct., 3 15/16" x 3 1/2", White, Double Layer Ply 96/cs.

57371160 11600 700 ct., 3 1/2" x 1000', White, Double Layer Ply 30/cs.

Heavenly Soft®

Heavenly Soft® is a premium quality tissue that is ultra soft and absorbent with an attractive floral embossing pattern on each sheet for a distinctive appearance. This premium bath tissue provides you comfort and strength in an attractive convenient package. Ideal for hospitality venues, healthcare facilities, and small businesses.

57371233 11233 1000 ct., 4 1/10" x 3 1/2", White, Individually Wrapped, 1-Ply 96/cs.

57370231 11231 1000 ct., 4 1/2" x 3 3/4", White, Individually Wrapped, 1-Ply 96/cs.

57372230 12230 200 ct., 4 1/10" x 3 1/2", White, 4 Roll Pack, 2-Ply 96/cs.

57371232 11232 500 ct., 4 1/10" x 3 1/2", White, Individually Wrapped, 2-Ply 96/cs.

57370230 11230 500 ct., 4 1/2" x 3 3/4", White, Individually Wrapped, 2-Ply 96/cs.

B. TOILET TISSUE

WAUSAU PAPER/BAY WEST

Dubl-Nature®

Dubl-Nature® Green Seal™ certified universal tissue features a floral embossing pattern.

Made from a superior grade of 100% recycled wastepaper, Dubl-Nature® tissue contains up to 43% post-consumer wastepaper.

30030045 59890 500 ct., 4 3/8" x 3 3/4", 2-Ply 80/cs.

DublSoft®

Premium quality, softness and absorbency.

30036348 06348 500 ct., 4 3/8" x 4", White, 2-Ply 48/cs.

30036380 06380 500 ct., 4 3/8" x 4", White, 2-Ply 80/cs.

30036390 06390 800 ct., 3 3/4" x 4", White, 2-Ply 36/cs.

EcoSoft™ Controlled-Use

EcoSoft™ bath tissue is 100% recycled and contains a minimum of 20% post-consumer waste, which meets EPA guidelines.

30030548 54800 500 ct., 4 3/8" x 3 3/4", White, 2-Ply 48/cs.

30030616 61600 616 ct., 3 3/4" x 4", White, 2-Ply 48/cs.

EcoSoft™ Controlled-Use Green Seal™

Green Seal™ certified and contains up to 49% post-consumer wastepaper. Made with de-inking and bleaching processes. Free of chlorine and other harmful chemicals.

30031990 61990 865 ct., 3 3/4" x 4", 2-Ply 36/cs.

EcoSoft™ Green Seal™

EcoSoft™ Green Seal™ bath tissue is 100% recycled and embossed for softness. This Green Seal™ certified bath tissue contains up to 49% post-consumer waste which exceeds EPA guidelines.

30034900 54900 500 ct., 4 3/8" x 3 3/4", White, 2-Ply 96/cs.

EcoSoft™ Universal

EcoSoft™ single roll universal tissue is 100% recycled fibers. Contains 20% post-consumer recovered materials. Meet EPA guidelines for wastepaper content.

30030009 14000 1000 ct., 4 3/8" x 3 3/4", 1-Ply 96/cs.

30030001 54000 500 ct., 4 3/8" x 3 3/4", 2-Ply 96/cs.

Jumbo Toilet Tissue



JUMBO TOILET TISSUE

A. JUMBO TOILET TISSUE PRIME SOURCE®

Green Source™

100% recycled. Chlorine-free. EcoLogo® Certified. Trilingual packaging (English, Spanish, French).

75009505	75009505	3 ⁹ / ₁₁ " x 550', 2-Ply	12/cs.
75009506	75009506	3 ⁹ / ₁₁ " x 750', 2-Ply	12/cs.

Prime Source®

High quality, value priced tissue ideal for all public environments.

75004351	75004351	3 ⁷ / ₈ " x 2000', White, 1-Ply, Universal	12/cs.
75004352	75004352	3 ⁷ / ₈ " x 4000', White, 1-Ply, Universal	6/cs.
76004358	76004358	3 ⁷ / ₈ " x 1000', White, 2-Ply, Universal	12/cs.
750043583	75004358C	3 ⁷ / ₈ " x 1000', White, 2-Ply, Universal	12/cs.
75004361	75004361	3 ⁷ / ₈ " x 1000', 8 ⁹ / ₁₀ " Roll dia., White, 2-Ply, Universal	12/cs.
75004359	75004359	3 ⁷ / ₈ " x 2000', White, 2-Ply, Universal	6/cs.



B. HI-VALU JUMBO ROLL TISSUE HI-VALU

Jumbo tissue is high quality and value priced. Ideal for all public environments.

73004356	73004356	3 ¹ / ₅ " x 700', White, 2-Ply	12/cs.
73004357	73004357	3 ² / ₅ " x 700', White, 2-Ply	12/cs.
73004358	73004358	3 ² / ₅ " x 1000', White, 2-Ply	12/cs.



C. ACCLAIM® JUMBO ROLL BATH TISSUE GEORGIA-PACIFIC

Economical bathroom tissue in a long-lasting jumbo junior roll format now in better packing and efficient put up case size.

13703718	13718	3 ¹ / ₂ " x 2000', 3 ¹ / ₃ " Core, White, 1-Ply	8/cs.
13703728	13728	3 ⁶ / ₁₁ " x 1000', 3 ¹ / ₃ " Core, White, 2-Ply	8/cs.

D. JUMBO ROLL TISSUE KIMBERLY-CLARK

Kleenex® Cottonelle® JRT® JR

All the benefits of jumbo tissue with Kleenex® quality.

15403148	03148	3 ¹⁰ / ₁₁ " x 1000', White, 2-Ply	4/cs.
----------	-------	---	-------

Scott® 100% RF JRT JR

Made with 100% recycled fiber. Meets EPA standards for 40% minimum post-consumer waste content. Green Seal™ Certified.

15406722	67223	3 ⁹ / ₁₁ " x 2000', White, 1-Ply	12/cs.
15406780	67805	3 ⁶ / ₁₁ " x 1000', White, 2-Ply	12/cs.

Scott® Coreless JRT® JR

Brings together high capacity bathroom tissue and innovation. With this system there are no cores and no headaches. This product meets EPA guidelines for post-consumer waste with a minimum 45% post-consumer recycled waste. Elemental chlorine-free (ECF). Will reduce packaging waste by 45% when compared to cored JRT. Designed for the electronic coreless JRT dispenser but will work in all manual coreless dispensers as well.

15407005	07005	3 ⁷ / ₁₀ " x 2300', White, 1-Ply	12/cs.
15407006	07006	3 ⁷ / ₁₀ " x 1150', White, 2-Ply	12/cs.
15407007	07007	3 ⁷ / ₈ " x 1000', White, 2-Ply	12/cs.

Scott® JRT® JR

Ideal for high traffic areas. Meets EPA Standards for minimum post-consumer waste content.

15407224	07223	3 ¹ / ₂ " x 2000', White, 1-Ply	12/cs.
15400373	07805	3 ¹ / ₂ " x 1000', White, 2-Ply	12/cs.

Scott® Surpass® JRT®

Since each roll is the equivalent of more than ten standard rolls, you will save upkeep time without sacrificing quality.

15407202	07202	3 ⁴ / ₅ " x 4000', White, 1-Ply	6/cs.
15400374	07827	3 ⁴ / ₅ " x 2000', White, 2-Ply	6/cs.





Jumbo Toilet Tissue

PAPER PRODUCTS



A. ROSES JUMBO ROLL TISSUE ROSES SOUTHWEST PAPER

Jumbo roll tissue.

59341148	01148	3 ³ / ₈ " x 800', White, 2-Ply	12/cs.
59341149	01149	3 ³ / ₈ " x 1000', White, 2-Ply	12/cs.
59341145	01145	3 ³ / ₈ " x 2000', White, 2-Ply	6/cs.

B. JUMBO ROLL BATH TISSUE SCA TISSUE

Tork® Advanced
Tork® Advanced jumbo bath tissue's high capacity provides fewer refills and reduces labor. Large size is pilfer proof, hard to conceal. Can't use at home. Reduced stub roll means less waste. Fewer cores and no wrappers leads to source reduction. Less storage space is needed. Perforated. Rapid break-up capability is ideal for all plumbing systems. Made from 100% recycled fiber provides environmental benefits. A positive image builder. EcoLogo® Certified.

14103902	12013903	3 ³ / ₈ " x 1200', T2 System, Mini, 1-Ply	12/cs.
14100055	11010402	3 ³ / ₈ " x 2247', 10" dia., T1 Refill, 1-Ply	6/cs.
14104402	12024402	3 ³ / ₈ " x 751', White, T2 System, 2-Ply	12/cs.
14100920	TJ0921A	3 ⁵ / ₈ " x 1000', 3 ³ / ₁₀ " Core dia., White, 2-Ply	12/cs.
14101503	12021502	3 ⁵ / ₈ " x 1600', 10" Roll dia., White, 2-Ply	6/cs.

Tork® Universal

Soft, absorbent tissue delivers quality, value and performance. Rapid break-up capability. Core is designed to fit virtually all size jumbo tissue dispensers. Smaller case cubes free up about 40% more storage space vs. conventional rolls. Made from 100% recycled fibers. EcoLogo® Certified. 3³/₁₀" core dia.

14100914	TJ0912A	3 ⁵ / ₈ " x 2000', 8 ¹ / ₂ " Roll dia., White, 1-Ply	12/cs.
14101214	TJ1212A	3 ⁵ / ₈ " x 4000', 11 ³ / ₄ " Roll dia., White, 1-Ply	6/cs.

Soft, absorbent two-ply jumbo tissue delivers quality, value and performance. Made from 100% recycled fibers with no added dyes or fragrances. Rapid break-up capability is ideal for all plumbing systems. Universal core is designed to fit virtually all size jumbo tissue dispensers. EcoLogo® Certified.

14100924	TJ0922A	3 ⁵ / ₈ " x 1000', 8 ¹ / ₂ " Roll dia., White, Mini, 2-Ply	12/cs.
14101224	TJ1222A	3 ⁵ / ₈ " x 2000', 11 ³ / ₄ " Roll dia., White, 2-Ply	6/cs.

C. JUMBO ROLL TISSUE SOFIDEL AMERICA

Biodegradable
Non-perforated, soft, and biodegradable. One roll provides the equivalent in length of more than ten standards rolls, helping reduce run-out and maintenance cost. Fits most jumbo dispensers. 3³/₈" core.

57371300	JT10002	1000', 9" Roll dia., White, 2-Ply	12/cs.
57371303	JT20002	2000', 12" Roll dia., White, 2-Ply	6/cs.

Generic
Generic jumbo roll tissue.

57370007	13938	3 ³ / ₈ " x 500'	12/cs.
----------	-------	--	--------

Heavenly Choice™ Double Layer
Made from heavier-weight paper, this innovative one-ply tissue offers the luxurious look, strength and softness of a two-ply for a surprisingly competitive price. Double Layer enables you to offer a superior product to your customers while realizing significant cost savings. Environmentally-friendly Double Layer takes less paper to produce and results in less waste being sent to landfills. High quality embossed, equivalent to national brands. Ideal for a wide range of low and high-traffic settings like business offices, healthcare and hospitality facilities. Made with fiber from sustainable sources.

57373643	13643	750', Double Layer Ply, 7 ³ / ₈ " dia., Mini Jumbo	12/cs.
----------	-------	--	--------

Heavenly Soft®
Offer great value with exceptional performance. Jumbo rolls have more feet per roll than standard bathroom tissue rolls, allowing for less frequent roll changes and reducing maintenance costs. An excellent choice for high-traffic areas such as hotels, public facilities, office buildings, food service and healthcare facilities.

57373231	13231	3 ¹ / ₂ " x 2000', 1-Ply	12/cs.
57373230	13230	3 ¹ / ₂ " x 1000', 2-Ply	12/cs.

Jumbo & Folded Toilet Tissue/Standard Dispensers



A. PRESERVE® JUMBO ROLL TISSUE VON DREHLE ENTERPRISES

A perfect combination of quality and economy, these economically priced jumbo rolls are ideal for high-traffic locations. With fewer refills required, maintenance time is reduced up to 90% and the larger roll helps control pilferage. Fast breakup means this tissue will not clog plumbing, and is safe for use in septic systems.

71590003 150915 1000', 9" dia., 3/8" Core, 2-Ply 15/cs.



B. UNIVERSAL JUMBO BATH TISSUE WAUSAU PAPER/BAY WEST

EcoSoft™

Large 3 7/8" core fits most jumbo dispensers. 100% recycled and contains a minimum of 20% post-consumer waste, which meets EPA guidelines.

30031002 10020 3 7/8" x 1000', 9" dia., White, 2-Ply 12/cs.

30032002 20020 3 7/8" x 2000', 12" dia., White, 2-Ply 6/cs.

EcoSoft™ Green Seal™

Green Seal™ certified and contains up to 49% post-consumer wastepaper. Made with de-inking and bleaching processes. Free of chlorine and other harmful chemicals.

30031029 10029 3 7/8" x 1000', 2-Ply 12/cs.



FOLDED TOILET TISSUE

C. ACCLAIM® FOLDED TOILET TISSUE GEORGIA-PACIFIC

Hygienic economy bath tissue with controlled, single-sheet dispensing.

13700688 10101 400 ct., 4" x 5", White, 2-Ply 60/cs.

D. KLEENEX® HYGIENIC FOLDED TOILET TISSUE KIMBERLY-CLARK

Hygienic toilet tissue combines softness with handsome packaging and easy maintenance.

Fully enclosed tissue system reduces potential of product contamination.

15400332 48280 250 ct., 4 1/2" x 8 1/3", White, 2-Ply 900/cs.



STANDARD TOILET TISSUE DISPENSERS

E. PRIME SOURCE® OPTICORE TISSUE DISPENSER PRIME SOURCE®

Designed for high capacity applications and features a locking cover to prevent product pilferage and waste. When installed according to the ADA guidelines, this dispenser is ADA Title III compliant.

75004357 75004357 2-Roll, Black Translucent 1/ea.



F. PRIME SOURCE® OPTICORE TISSUE DISPENSER PRIME SOURCE®

Fits three rolls of toilet tissue, reducing maintenance time and labor. See-through design lets you know when you need to re-stock. When one roll of tissue is used, simply turn the dial to advance to the next roll.

75004356 75004356 3-Roll, Black Translucent 1/ea.



G. PRIME SOURCE® TISSUE DISPENSER PRIME SOURCE®

Tissue dispenser holds two rolls.

750043401 75004340 2-Roll, Black Translucent 1/ea.

75004340 75004340 2-Roll, Black Translucent 105/cs.

H. PRIME SOURCE® TISSUE DISPENSER PRIME SOURCE®

Tissue dispenser holds four rolls.

750043371 75004337 4-Roll, Black Translucent 1/ea.

75004337 75004337 4-Roll, Black Translucent 60/cs.





Standard & Jumbo Toilet Tissue Dispensers

PAPER PRODUCTS



A. DELUXE SHORELINE TOILET TISSUE HOLDER CCP

Zinc die cast bright chrome finish. Concealed hinge button at end, tension spring controls tissue flow.
276008151 815 2⁷/₁₆" x 5¹/₂" x 4⁵/₁₆", Single Roll 1/ea.



B. TOILET TISSUE HOLDERS CCP

Classic roll tissue holders. Pilfer-proof locking device-brake spring action. Conforms to Federal Spec. WW-H-001911.
276009901 RT22 2³/₄" x 6" x 4¹/₄", Single Roll, Chrome 1/ea.
276009891 RT23 2³/₄" x 11" x 4¹/₄", Double Roll, Chrome 1/ea.



C. TORK® ELEVATION HIGH CAPACITY ROLL TISSUE DISPENSER SCA TISSUE

The Tork® high-capacity tissue dispensing system is a perfect fit for washrooms with limited space. An innovative auto-transfer feature promotes hygiene and reduces refill maintenance time. Promotes hygiene with covered roll and auto-transfer features. Prevents waste by dropping the reserve roll only after the primary roll is depleted. Keeps used roll core in the unit, keeping washroom floors clear of debris. Holds up to 2,000 2-ply or 4,000 1-ply sheets. Contains 60 percent more tissue than conventional bath tissue dispensers. Permits quicker, easier loading and fewer refills, reducing maintenance time. Prevents pilferage and reduces waste with enclosed design. Requires rolls with core plugs.
14100432 555628A T26 System, Black 1/ea.



D. DUETT® TOILET TISSUE DISPENSER SAN JAMAR

Standard bath tissue dispenser is the ideal companion to any towel dispenser. The Duett eliminates waste by protecting a visible fresh roll until the first roll is completely used. Accommodates two standard bath tissue rolls of 4¹/₂" to 5¹/₂".
62573500 R3500TBK 12³/₄"H x 7¹/₂"W x 7"D, 2 Roll, Black Pearl 6/cs.



E. TOILET TISSUE DISPENSER SAN JAMAR

Tension springs prevent free rolling of tissue. Anti-theft lock prevents tissue roll theft. 1¹/₂" core size.
62570040 R260XC 2³/₄"H x 12³/₈"W x 4¹/₂"D, Dual 12/cs.



F. SILHOUETTE® REVOLUTION™ 3-ROLL OPTICORE™ TISSUE DISPENSER WAUSAU PAPER/BAY WEST

The Revolution™ three-roll tissue dispenser is designed for high-capacity controlled-use dispensing of OptiCore™ tissue products. When one roll of tissue is used, simply turn the dial to advance to the next roll. The OptiCore™ technology ensures the maximum use of each roll in the Revolution™ dispenser to save maintenance time and costs. The Revolution™ is ADA Title III compliant when installed according to ADA guidelines. This sleek, contemporary dispenser also features a locking cover to prevent product pilferage and waste.
30030300 80300 14⁹/₁₆" x 14⁹/₁₆" x 6⁵/₁₆", Black Translucent 1/ea.



JUMBO TOILET TISSUE DISPENSERS

G. IN-SIGHT® CORED JRT® COMBO UNIT DISPENSER KIMBERLY-CLARK

Combination JRT® dispenser can be used with two JRT® Junior rolls or one JRT® Senior roll and a stub roll. An easy-to-use mechanism adjusts to meet the customer's needs. Can be used with or without a key.
15400551 09551 20²/₈"W x 13¹/₁₀"H x 5⁴/₈"D, Smoke/Gray 1/ea.

Jumbo & Folded Dispensers/Facial Tissue



**A. IN-SIGHT® SERIES I
JRT JR. ESCORT® TISSUE DISPENSER** **KIMBERLY-CLARK**
Jumbo roll tissue dispenser is curved and contemporary, creating the best impression for your restrooms. Designed for easier access to tissue. Replaceable lock with push button option. Spare parts attached to back wall. Smoke transparent design for easy maintenance.
15409507 09507 13⁷/₈" x 16" x 5³/₄", Smoke 1/ea.



**B. RENAISSANCE™ TWIN JUMBO
TOILET TISSUE DISPENSER** **SAN JAMAR**
Twin 9" jumbo bath tissue dispenser is the most versatile jumbo bath tissue dispenser due to its slim and compact size. Slider prevents access to the spare roll until the first roll is completely empty. Universal and dispenses any brand or quality of jumbo bath tissue. Break-resistant plastic.
62574000 R4000TBK 12" x 19" x 5¹/₄", Black Pearl 4/cs.



C. VERSATWIN® TOILET TISSUE DISPENSER **SAN JAMAR**
For all brands of standard and industrial size bath tissue up to 5¹/₂" diameter. Provides uninterrupted flow of paper, eliminating stub roll waste and reducing maintenance costs. Contemporary design saves space, prevents theft, and encloses rolls for maximum hygiene. Break and chemical-resistant. Mounts in any position. Patent pending. Capacity of two rolls 5¹/₂" diameter, 4¹/₂" wide. Core of 1¹/₂".
62573600 R3600TBK (2) 4¹/₂" - 5¹/₂" Rolls, 8" x 12⁷/₁₀" x 5³/₄", Black Pearl 6/cs.



**D. TORK® BATH TISSUE JUMBO
ROLL TWIN DISPENSER** **SCA TISSUE**
Holds two rolls. See-through front reduces maintenance, allows quick and easy service checks. Elegant appearance complements any decor. High impact flame retardant, chemical-resistant, rigid vinyl plastic provides years of low maintenance, trouble-free service. Large capacity dispenser goes longer between refills.
14101020 56T1 19⁹/₁₀"W x 11¹/₅"H x 5¹/₂"D, Smoke/Gray 1/ea.



**E. TORK® ELEVATION
JUMBO ROLL TISSUE DISPENSER** **SCA TISSUE**
Our new design ensures easy and intuitive maintenance, refilling and use. A perfect choice for high-traffic washrooms as well as environments where efficiency and reduced cost are priorities. A new stub roll feature provides extra high capacity. Goes longer between refills and reduces maintenance costs. The unique tear feature eliminates risk of cutting or scratching hands. Roll is protected, creating less waste, improved hygiene and reduced pilferage. This durable ABS Polystyrene provides low maintenance and trouble-free service. Replaces 340080. Also Available in Black 554028A.
14100425 554020A 17¹/₅"W x 14¹/₅"H x 5¹/₅"D, White 1/ea.



FOLDED TOILET TISSUE DISPENSER

F. TOILET TISSUE DISPENSER **CCP**
Combination tissue cabinet. For single or double fold tissue see-through gauge.
276014011 401SD 7" x 4¹/₂" x 3³/₁₆", White 1/ea.

FACIAL TISSUE

G. PRIME SOURCE® FACIAL TISSUE **PRIME SOURCE®**
High quality, value priced tissue ideal for all public environments.
75004342 75004342 100 ct., 8" x 8²/₅", White, 2-Ply 30/cs.



H. HI-VALU FACIAL TISSUE **HI-VALU**
Facial tissue is high quality and value priced. Ideal for all public environments.
73004400 73004400 100 ct., 7⁷/₈" x 7⁷/₈", White, 2-Ply 30/cs.



Facial Tissue

PAPER PRODUCTS



A. FACIAL TISSUE

GEORGIA-PACIFIC

Angel Soft® PS

Premium quality facial tissue is soft and absorbent.

13706581 46580 96 ct., 4³/₈" x 4³/₈" x 5¹/₄", White, Cube Box, 2-Ply 3456/cs.

Angel Soft® PS Ultra™ Premium

Brings an added touch of luxury to our premium line. Offers premium softness and quality for at-home comfort away from home. Includes convenient color indicator sheets signaling the need for refilling. This designer cube box coordinates with Angel Soft® ps Ultra™ bath tissue.

13706561 46560 96 ct., 7³/₈" x 8¹/₂" Sheets, White, Cube Box, 2-Ply 36/cs.

Preference®

Soft, absorbent, value-oriented facial tissue with elegant iris emboss.

13704810 48100 100 ct., 7⁷/₁₆" x 9", White, 2-Ply 30/cs.



B. FACIAL TISSUE

KIMBERLY-CLARK

Kleenex®

Experience the extraordinary sensation of Kleenex® lotion. Softness with a delightful touch of lotion. Our most soothing tissue.

15401002 21002 65 ct., 8²/₅" x 8²/₅", White, 3-Ply 36/cs.

Kleenex® Anti-Viral

Now you can give your customers, employees and visitors the same assurance they can get at home. Kleenex® Anti-Viral Facial Tissue is the only tissue on the market proven to kill 99.9% of cold and flu viruses. This innovative new product is ideal for office buildings, schools, restaurants and doctor/dental offices.

15408075 28075 75 ct., 8²/₅" x 8¹/₅", White, 3-Ply 27/cs.

Kleenex® Boutique®

Offers the ideal tissue performance combined with handsome packaging and easy maintenance. A Signal® feature alerts you when it's time to change the box.

15407061 2127060 95 ct., 8²/₅" x 8²/₅", White, Decorative Box, 2-Ply 3420/cs.

15407619 21271 95 ct., 8²/₅" x 8²/₅", White, Decorative Box, 2-Ply, 3420/cs.

6 Boxes

15400010 21200 95 ct., 8²/₅" x 8²/₅", White, Floral Box, 2-Ply 12/cs.

15406910 21269 95 ct., 8²/₅" x 8²/₅", White, Floral Box, 2-Ply 3420/cs.

Kleenex® Signal®

Kleenex® facial tissue delivers premium quality with outstanding value. The Signal® feature alerts you when it's time to change the box.

15405152 25152 45 ct., 8²/₅" x 8³/₅", White, 2-Ply 1080/cs.

15407610 21195 65 ct., 8²/₅" x 5¹/₅", Junior, White, 2-Ply 3120/cs.

15403036 21005 100 ct., 8²/₅" x 8²/₅", White, 2-Ply 3000/cs.

15407606 21400 100 ct., 8²/₅" x 8²/₅", White, Flat Box, 2-Ply 3600/cs.

15407621 0307620 125 ct., 8²/₅" x 8²/₅", White, 2-Ply 12/cs.

15400371 21606 125 ct., 8²/₅" x 8²/₅", White, 2-Ply 6000/cs.

154014145 21414 10/100 ct., 8²/₅" x 8²/₅", White, 2-Ply 10/cs.

Kleenex® Lotion Brand

Experience the extraordinary sensation of Kleenex® lotion. Softness with a delightful touch of lotion. Our most soothing tissue.

15401267 25829 75 ct., 8²/₅" x 8²/₅", Cube Box, 3-Ply 27/cs.

15406081 26080 80 ct., 8²/₅" x 8²/₅", White, 3-Ply 27/cs.

Kleenex® Naturals Boutique™

Made with SoftBlend™ fiber, the perfect blend of soft, virgin fiber and 20% post-consumer recycled fiber. The result is a quality tissue that meets the high standards of Kleenex® Brand. Exceeds EPA minimum standards for post-consumer waste content in facial tissue. FSC Certified.

15401078 21272 95 ct., 8²/₅" x 8¹/₅", 2-Ply 36/cs.

15401088 21601 125 ct., 8²/₅" x 8¹/₅", 2-Ply 48/cs.

Kleenex® Pocket Packet

These Kleenex® facial tissues have softness, strength and absorbency for your everyday needs. Pack a Kleenex® Pocket Packet wherever you go.

15401246 11976 3 Pack, 1¹/₅" x 4⁵/₅" x 1", 3-Ply 108/cs.

15400270 30140 15 ct., 8²/₅" x 8¹/₅", White, 2-Ply 1440/cs.

15403021 30210 15 ct., 8⁹/₁₀" x 16⁹/₁₀", White, 2-Ply 2880/cs.

Facial Tissue



A. FACIAL TISSUE (CONT.)

KIMBERLY-CLARK

Scott® 100% RF Surpass

Made with 100% recycled fiber. Meets EPA standards for 40% minimum post-consumer waste content. Green Seal™ Certified.

15401295	21295	110 ct., 8" x 8 ¹ / ₃ ", White, 2-Ply, Boutique	3960/cs.
15401285	21285	125 ct., 8" x 8 ¹ / ₃ ", White, 2-Ply, Flat	60/125/cs.

Scott® Surpass®

Features 50% more tissues per box than standard tissue boxes. The Signal® feature alerts you when it's time to change the box. Meets EPA guidelines for post-consumer waste.

15400038	03131	100 ct., 8" x 8 ¹ / ₂ ", White, 2-Ply	1200/cs.
----------	-------	---	----------

Surpass® Boutique®

Features 50% more tissues per box than standard tissue boxes. The Signal® feature alerts you when it's time to change the box. Meets EPA guidelines for post-consumer waste.

15401342	21320	100 ct., 8" x 8 ¹ / ₃ ", White, Cube Box, 2-Ply	3960/cs.
15401340	21340	100 ct., 8" x 8 ¹ / ₃ ", White, Flat Box, 2-Ply	30/cs.
15401390	21390	125 ct., 8" x 8 ¹ / ₃ ", White, Flat Box, 2-Ply	60/cs.
15405851	21380	150 ct., 8" x 8 ¹ / ₃ ", White, Flat Box	96/cs.



B. FACIAL TISSUE

MARCAL PAPER MILLS

Aspen®

Two-ply facial tissue. 100% recycled. Whitened without chlorine bleaching. Hypoallergenic. Virtually lint-free. No dye or fragrance.

15703306	3305	144 ct., 9" x 7 ¹ / ₂ ", White, Flat Box, 2-Ply	36/cs.
----------	------	---	--------

Marcal Pro™ 100% Premium Recycled

Made with a minimum of 60% post consumer content. Meets or exceeds EPA guidelines for post consumer content. 100 tissues per box. Great for all offices, including hospitality and health care. Hypoallergenic. Whitened without chlorine bleaching. No dye or fragrance added. Virtually lint-free.

15702930	2930	100 ct., 8 ¹ / ₂ " x 7 ¹ / ₂ ", White, Flat Box, 2-Ply	3000/cs.
----------	------	--	----------

Small Steps®

Made with a minimum of 60% post consumer content. Meets or exceeds EPA guidelines for post consumer content. 80 tissues/box, 6 boxes/bundle. Great for all offices. Hypoallergenic. Whitened without chlorine bleaching. No dye or fragrance added. Virtually lint-free.

15704034	4034	80 ct., 9" x 8 ¹ / ₃ ", White, Bundle, 2-Ply	36/cs.
----------	------	--	--------



C. PUFFS® FACIAL TISSUE

PROCTER & GAMBLE

Quality softness you can trust. Strong and absorbent tissues.

16904457	34457	200 ct., 18 ² / ₅ " x 15 ⁴ / ₅ " x 19 ¹ / ₅ ", Rectangular Carton, 2-Ply	24/cs.
----------	-------	--	--------

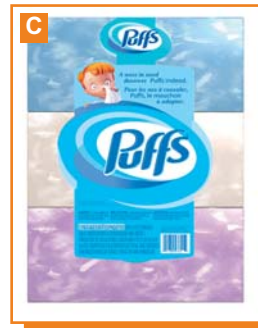

D. BELLA DONNA FACIAL TISSUE

ROSES SOUTHWEST PAPER

Facial tissue.

59342172	52172	100 ct., 8 ¹ / ₂ " x 7 ¹ / ₂ ", White, 2-Ply	30/cs.
----------	-------	--	--------



E. FACIAL TISSUE

SCA TISSUE

Tork® Advanced

Extra soft and absorbent two-ply facial tissue offers the right combination of performance and value. Soft shield protects the tissues and provides easy, one-at-a-time dispensing. The flat box style is ideal for the vanity or in-wall dispensers. Made from 100% recycled fibers, helps conserve natural resources. Dispenser box is manufactured from 100% recycled materials with a minimum of 15% Post Consumer materials.

14106811	TF6810	100 ct., 8 ¹ / ₅ "W x 7 ⁹ / ₁₀ "L Sheets, White, 2-Ply	30/cs.
----------	--------	--	--------

Tork® Premium

Ultra soft, premium two-ply tissue tells users you care about their comfort. A different color indicator sheet shows when the tissue box is nearly empty. Soft shield protects the tissues and provides easy, one-at-a-time dispensing. Cube box style is ideal for the vanity or in-wall dispensers. Dispenser box is manufactured from 100% recycled materials with a minimum of 35% Post Consumer materials.

14106910	TF6910	94 ct., Cube Box, 8 ¹ / ₅ " x 7 ⁹ / ₁₀ "L, White, 2-Ply	36/cs.
----------	--------	---	--------

Tork® Universal

Soft and absorbent two-ply facial tissue offers the right combination of performance and value. The flat box style is ideal for the vanity or in-wall dispensers. Made from 100% recycled fibers, helps conserve natural resources. Dispenser box is manufactured from 100% recycled materials with a minimum of 15% Post Consumer materials.

14106710	TF6710A	100 ct., 8 ¹ / ₅ "W x 7 ⁹ / ₁₀ "L Sheets, White, 2-Ply	3000/cs.
----------	---------	--	----------



PAPER PRODUCTS



Facial Tissue/Roll Towels



A. CELLUSOFT FACIAL TISSUE **SOFIDEL AMERICA**
 Two-ply facial tissue. Soft and strong. Pop-up box with single sheet dispensing.
57371480 21480 100 ct., 8" x 8", 2-Ply 30/cs.



B. FACIAL TISSUE **WAUSAU PAPER/BAY WEST**
DublSoft®
 DublSoft® premium facial tissue provides the most discriminating customer with softness, strength and absorbency.
30036100 DS6100 100 ct., 9" x 8", White, Flat Box, 2-Ply 3000/cs.
EcoSoft™ Green Seal™
 EcoSoft™ facial tissue is Green Seal™ certified. Made from 100% recycled fibers and meets EPA guidelines with 10% post-consumer waste.
30034901 15000 150 ct., 8¾" x 8", 2-Ply 30/cs.

ROLL TOWELS



C. ROLL TOWELS **PRIME SOURCE®**
Green Source™
 100% recycled. Chlorine-free. EcoLogo® Certified. Trilingual packaging (English, Spanish, French).
75009525 75009525 7¾" x 300', Natural, Standard 12/cs.
75009520 75009520 7¾" x 300', White, Standard 12/cs.
75009535 75009535 7¾" x 700', Natural, Jumbo 6/cs.
75009530 75009530 7¾" x 700', White, Jumbo 6/cs.
Prime Source®
75004322 75004322 8" x 350', Natural 12/cs.
75004324 75004322 8" x 350', Natural 12/cs.
75004321 75004321 8" x 350', White 12/cs.
75004314 75004321 8" x 350', White 12/cs.
75004315 75004315 8" x 630', Leaf Embossed 6/cs.
75004324 75004324 8" x 800', Natural 6/cs.
75004324 75004324 8" x 800', Natural 6/cs.
75004323 75004323 8" x 800', White 6/cs.
75004326 75004326 11" x 157½', 210 ct., White 12/cs.



Prime Source® Hardwound
 High quality, value priced paper towel ideal for all public environments.
75004334 75004334 8" x 450', White 12/cs.
75004332 75004332 8" x 800', Natural 6/cs.
75004333 75004333 8" x 800', White 6/cs.

D. HI-VALU ROLL TOWELS **HI-VALU**
 Universal roll towels are high quality and value priced. Ideal for all public environments.
73004329 73004329 7¾" x 320', Natural 12/cs.
73004322 73004322 7¾" x 350', Natural 12/cs.
73004328 73004328 7¾" x 320', White 12/cs.
73004321 73004321 7¾" x 350', White 12/cs.
73004334 73004334 7¾" x 600', Natural 96/cs.
73004333 73004333 7¾" x 600', White 12/cs.
73004324 73004324 7¾" x 800', Natural 6/cs.
73004323 73004323 7¾" x 800', White 6/cs.



E. ROLL TOWELS **GEORGIA-PACIFIC**
Cormatic®
 High capacity, thru-embossed towels on non-slot rolls. Delivers the softness, quick absorbency, durability and thickness patrons appreciate. Fits Cormatic®, Guardian®, Ultimatic® no-touch, high-capacity towel dispensers.
13701587 2910P 930 ct., 8¼"W, Brown 6/cs.
13701588 2930P 930 ct., 8¼"W, White 6/cs.
enMotion®
 High capacity, high quality, EPA compliant for environmentally concerned customers, refill roll towels for enMotion recessed or Impulse 8 automated towel dispenser.
13708944 89440 8¼" x 700', Brown 6/cs.
13700122 89480 10" x 800', Brown, 1-Ply, EcoLogo® Certified 6/cs.
13709461 89460 10" x 800', White, 1-Ply 6/cs.

PAPER PRODUCTS

Roll Towels



A. ROLL TOWELS (CONT.)

GEORGIA-PACIFIC

Envision®

Economy hardwound roll towels. EPA compliant for environmentally concerned customers. Delivers reliable performance at a low cost.

13700444	26401	7 ⁷ / ₈ " x 350', 1 ¹ / ₂ " Core, Brown, 1-Ply	12/cs.
13707656	26200	7 ⁷ / ₈ " x 625', 1 ⁵ / ₈ " Core, Brown, 1-Ply	12/cs.
13706301	26301	7 ⁷ / ₈ " x 800', 1 ⁵ / ₈ " Core, Brown, 1-Ply	6/cs.

Towlmastr® Max 2000

Super absorbent, high-quality roll towels for the MAX 2000 roll towel dispenser system.

13701464	81464	7 ⁷ / ₈ " x 700', Brown, X-Groove	6/cs.
-----------------	-------	---	-------

Towlmastr® Series 2000

Roll towels for the Towlmastr® Series 2000® roll towel dispenser offer a cost-effective, high-capacity system perfectly suited for any washroom. 450' roll delivers up to 338 hand dryings for continuous service and reduced maintenance.

13701970	19724	7 ⁷ / ₈ " x 450', Kraft, X-Groove, 1-Ply	12/cs.
-----------------	-------	--	--------

Ultima®

Ultra-premium white thru-embossed refill roll towels for complete patron satisfaction. Designed for G-P Ultimatic hands-free, portion-controlled towel systems.

13701584	2530	567 ct., 8 ¹ / ₄ ", White	12/cs.
-----------------	------	---	--------



B. HARD ROLL TOWELS

KIMBERLY-CLARK

Kleenex®

Have absorbency pockets that absorb lots of water fast for superior hand drying. Soft premium towel with embossed pattern. Meet EPA standards with a minimum of 40% post-consumer waste.

15401080	01080	8" x 425', White, 1-Ply	12/cs.
15400606	50606	8" x 600', White, Zip-Off Top Pack	6/cs.
15405060	50606	8" x 600', White, Zip-Off Top Pack	12/cs.
15401091	11090	8" x 600', White, Zip-Off Top Pack, FSC Certified	6/cs.

Scott®

Scott® roll towels provide reliable quality, softness, and absorbency.

15402068	02068	8" x 400', 7 ⁷ / ₈ " Roll dia., White, 1-Ply	12/cs.
15400375	01040	8" x 800', White, 1-Ply	12/cs.

Scott® - 40% post-consumer

Made of 40% post-consumer waste content; elemental chlorine-free (EFC) bleaching; packaging reduction through providing greater feet per case. 19% more towels on each core.

15402000	02000	8" x 950', 1 ³ / ₄ " Core, White, 1-Ply	6/cs.
-----------------	-------	---	-------

Scott® - 60% Post-Consumer

100% recovered materials; have a minimum of 60% post-consumer recycled waste; elemental chlorine-free (ECF) bleaching; and are made from recycled cardboard.

15400046	02021	8" x 400', Natural, 1-Ply	12/cs.
15404150	04142	8" x 800', Natural, 1-Ply	12/cs.

Scott® 100% RF

Made with 100% recycled fiber. Meets EPA standards for 40% minimum post-consumer waste content. Green Seal™ Certified.

15402031	02031	8" x 800', Natural, 1-Ply	12/cs.
15401052	01052	8" x 800', White, 1-Ply	12/cs.

Scott® High Capacity

More towels, same space, less time, soft and absorbent. 25% more feet without increasing roll diameter or sacrificing performance. Meets EPA standards with a minimum of 40% post-consumer waste content. Elemental chlorine-free (EFC) bleaching. Packaging reduction. 1¹/₂" core diameter, 7⁷/₈" roll diameter.

15401005	01005	8" x 1000', White, 1-Ply	6/cs.
15400376	01000	8" x 1000', White, 1-Ply	12/cs.

Scott® Slimroll

A true breakthrough in touchless hard roll technology, proving that good things do come in small, high performance packages! Dries in less space, the dispenser is nearly 50% smaller than standard Sanitouch dispensers. Towels feature absorbency pockets, one-at-a-time dispensing and exceed EPA minimums for post-consumer waste content. FSC Certified.

15401115	12388	696 ct. (10" Pre-Cut Sheets), 8" x 580', White, 1-Ply	6/cs.
-----------------	-------	---	-------

Tradition®

Maximum utility and value in these soft yet strong, hard-working paper towels that are designed to tackle tough jobs.

15404128	04128	8" x 350', Natural, 1-Ply	12/cs.
-----------------	-------	---------------------------	--------



PAPER PRODUCTS



Roll Towels



A. ROSES HARDWOUND ROLL TOWELS

ROSES SOUTHWEST PAPER

Hardwound roll towels.

59340200	205	7 ⁷ / ₈ " x 350', Bleached, 1-Ply	12/cs.
59340204	204	7 ⁷ / ₈ " x 350', Natural, 1-Ply	12/cs.
59340199	208	7 ⁷ / ₈ " x 600', Bleached, 1-Ply	12/cs.
59340201	207	7 ⁷ / ₈ " x 600', Natural, 1-Ply	12/cs.
59340197	210	7 ⁷ / ₈ " x 800', Bleached, 1-Ply	6/cs.
59340198	209	7 ⁷ / ₈ " x 800', Natural, 1-Ply	6/cs.



B. HAND ROLL TOWELS

SCA TISSUE

Tork® Advanced

Soft, strong, and highly absorbent, this towel offers the perfect combination of quality, performance, and value. Embossing enhances hand feel and maximum absorbency; fewer towels are used per hand dry. Less packaging means source reduction, reducing your overall labor and maintenance costs. Long-lasting rolls minimize maintenance costs while maximizing service. Towels are made from 100% recycled fiber provides environmental benefits. A positive image builder. EcoLogo® Certified.

14100489	290089	7 ⁷ / ₈ " x 700', White, 1-Ply	6/cs.
14101350	RB350A	7 ⁷ / ₈ " x 350', 1-Ply	12/cs.
14100600	RB600	7 ⁷ / ₈ " x 600', 1-Ply	12/cs.
14100800	RB800	7 ⁷ / ₈ " x 800', White, 1-Ply	6/cs.

Designed specifically for the Tork Matic® and Tork Intuition® roll towel dispensers. Offers a truly best-in-class product for no touch, hygienic dispensing systems. Quick-absorbing, thicker paper towel with improved softness and strength that feels more like cloth. Less packaging means source reduction, reducing your overall labor and maintenance costs. Long-lasting rolls minimize maintenance costs while maximizing service. Ideal for Class-A office buildings and upscale dining facilities. This product contains 100% recycled fiber content and a minimum of 25% Post Consumer fibers. Replaces 290092. EcoLogo® Certified.

14100338	290092A	7 ⁷ / ₈ " x 525', White, 2-Ply	6/cs.
14100485	290092	7 ⁷ / ₈ " x 525', White, 2-Ply	6/cs.

Tork® Universal

Soft, strong, and highly absorbent Tork® roll towels offer the perfect combination of quality, performance, and value. Towels are made from 100% recycled fiber. EcoLogo® and Green Seal™ Certified.

14100488	290088	7 ⁷ / ₈ " x 700', Natural, 1-Ply	6/cs.
-----------------	--------	--	-------

Ultra soft, ultra absorbent design. Deep embossing enhances hand feel and maximizes absorbency, fewer towels used per hand dry. Long-lasting rolls minimize maintenance costs while maximizing service. Towels are made from 100% recycled fiber and 40% Post Consumer fiber. EcoLogo® and Green Seal™ Certified.

14100050	RB425	7 ⁶ / ₈ " x 425', White	12/cs.
-----------------	-------	---	--------

Tork® Universal Hardwound

Soft, strong, and highly absorbent offering the perfect combination of quality, performance, and value. Embossing enhances hand feel and maximizes absorbency, fewer towels used per hand dry. Roll towel performance provides source reduction and less packaging. Long-lasting rolls minimize maintenance costs while maximizing service. Towels are made from 100% recycled fiber. EcoLogo® Certified.

14100104	RK206E	7 ⁷ / ₈ " x 206', Natural, 1-Ply	24/cs.
14101351	RK350A	7 ⁷ / ₈ " x 350', Natural, 1-Ply	12/cs.
14100351	RB351	7 ⁷ / ₈ " x 350', White, 1-Ply	12/cs.
14106000	RK600E	7 ⁷ / ₈ " x 600', Natural, 1-Ply	12/cs.
14106002	RB6002	7 ⁷ / ₈ " x 600', White, 1-Ply	12/cs.
14100103	RK800E	7 ⁷ / ₈ " x 800', Natural, 1-Ply	6/cs.

Roll Towels



A. HARDWOUND ROLL TOWELS

SOFIDEL AMERICA

The non-perforated one-ply roll towel is designed primarily for hand drying but they can also be used for any cleaning purposes. High quality with maximum absorbency. Designed to work with any universal roll towel dispenser.

57371304 HW350N 350', 2" Core, Natural, 1-Ply 12/cs.

Confidence™

Non-perforated roll towels provide effective hand drying with less paper waste. Fits most universal roll towel dispensers. Strong and absorbent. Made with fiber from sustainable sources.

57371501 41501 7⁷/₈" x 700', White, 1-Ply 6/cs.

Confidence™ Premium

Made with TAD (Thru-Air-Drying Technology). Non-perforated roll towels provide effective hand drying with less paper waste. Fits most universal roll towel dispensers. Strong and absorbent. Made with fiber from sustainable sources.

57372501 42501 10" x 600', White, 1-Ply 4/cs.

Heavenly Soft®

Made from 100% recycled paper. Non-perforated, strong, and absorbent. Provide effective hand drying with less paper waste. Fits most crank, lever, and hands-free roll towel dispensers.

57374123 41230 350', Natural, 1-Ply 12/cs.

57370232 41232 600', Natural, 1-Ply 12/cs.

57371239 41233 600', White, 1-Ply 12/cs.

57371236 41236 800', Natural, 1-Ply 6/cs.

57371237 41235 800', White, 1-Ply 6/cs.



B. ROLL TOWELS

WAUSAU PAPER/BAY WEST

Dubl-Nature® Controlled

Dubl-Nature® Green Seal™ certified embossed roll towels are 100% recycled and contain up to 43% post-consumer waste content. Featuring a consumer-like "leaf" embossing pattern for exceptional brightness and absorbency, these roll towels are a premium solution for your facilities that are concerned about their image and the environment.

30030038 38090 8" x 800', White 6/cs.

DublSoft® Controlled

DublSoft® controlled roll towels offer high-capacity benefits combined with a premium appearance. Features an exclusive "leaf" embossing design for superior softness, strength and absorbency. Controlled usage for value added cost savings when combined with controlled roll towel dispensing systems.

30036307 06307 7¹/₂" x 630', White 6/cs.

30036308 06308 8" x 630', White 6/cs.

EcoSoft™ Controlled

EcoSoft™ roll towels are made of 100% recycled paper and contain a minimum 40% post-consumer waste, which meets EPA guidelines.

30031600 71600 7¹/₂" x 630', White 6/cs.

30030713 71300 7¹/₂" x 800', Natural 6/cs.

30030097 71400 7¹/₂" x 800', Natural White 6/cs.

30030008 20100 8" x 425', Natural 12/cs.

30030214 21400 8" x 425', Natural White 12/cs.

30033160 31600 8" x 630', White 6/cs.

30030313 31300 8" x 800', Natural 6/cs.

30030117 31400 8" x 800', Natural White 6/cs.

EcoSoft™ Universal

EcoSoft™ roll towels are made of 100% recycled paper and contain a minimum 40% post-consumer waste, which meets EPA guidelines.

30030015 46200 8" x 350', Natural 12/cs.

30030016 46000 8" x 425', Natural 12/cs.

30030013 46500 8" x 425', White 12/cs.

EcoSoft™ Universal Green Seal™

Roll towels with a 1¹/₂" core can be dispensed through universal roll towel dispensers.

EcoSoft™ Green Seal™ roll towels are 100% recycled and made entirely from recovered fibers. Natural towels contain up to 82% post-consumer waste. Natural white towels contain up to 73% post-consumer waste.

30030463 46300 8" x 425', Natural White 12/cs.

30030458 45800 8" x 800', Natural 6/cs.





Centerpull Towels



CENTERPULL TOWELS

A. CENTERPULL TOWELS GEORGIA-PACIFIC

Preference®
 Refill centerpull towels for the smart Preference hands-free dispensing system.
13704000 44000 520 ct., 8¹/₄" x 12", White, 2-Ply 6/cs.

Sofpull®
 Premium, one-at-a-time dispensing, centerpull towels. Each sheet dispenses fully open and ready-to-use, delivering the right amount of toweling to handle any size clean-up quickly and easily. 2³/₈" core.
13708124 28124 320 ct., 7¹/₈" x 15", White, 1-Ply 6/cs.
13708143 28143 560 ct., 7¹/₈" x 15", White, 1-Ply 4/cs.

B. CENTERPULL TOWELS KIMBERLY-CLARK

Kleenex® Premiere®
 These towels dispense from the center of the roll, for simple one-handed use. Exclusive absorbency pockets.
15401076 01076 250 ct., 15" x 8", White, 1-Ply 6/cs.
15401320 01320 250 ct., 15" x 8", White, 1-Ply 4/250/cs.

Scott®
 These towels dispense from the center of the roll, for simple one-handed use.
15401061 01061 250 ct., 8" x 15", White, 1-Ply 1500/cs.
15401051 01051 500 ct., 8" x 15", White, 1-Ply 2000/cs.
15400345 01010 500 ct., 8" x 15", White, 2-Ply 2000/cs.

Scott® Roll Control
 Introducing a center-flow system that reduces dispensing problems (streaming, lost tail, and crumpled sheet appearance).
15403054 01032 750', 8" x 12", White, 2-Ply 6/cs.

C. ROSES CENTERPULL TOWELS ROSES SOUTHWEST PAPER

Bleached centerpull towels.
59342308 52308 600 ct., 9" Sheets, 2-Ply 6/cs.

D. CENTERFEED HAND TOWELS SCA TISSUE

Tork® Advanced
 Offer one-at-a-time service and reduced waste. High capacity reduces labor and refills. High absorbency means fewer towels used. Touch only dispensing towel reduces cross contamination. Made from 100% recycled fiber. Provides environmental benefits. A positive image builder. EcoLogo® Certified. Compostable Verified by Independent Verification. 2⁹/₁₀" core dia. White.
14100133 120133 1000 ct., 8¹/₄" x 11⁴/₈", 983', 7⁴/₈" Roll dia., 1-Ply 6/cs.
14101225 121225 266 ct., 8³/₁₀" x 11⁴/₈", 262', 5¹/₂" Roll dia., Mini, 2-Ply 12/cs.
14101204 121204 600 ct., 7²/₅"W x 590', White, 2-Ply 6/cs.
14101230 121201 600 ct., 9" x 11⁴/₈", 590', 7⁴/₈" Roll dia., 2-Ply 6/cs.
14100134 121202 610 ct., 8¹/₄" x 11⁴/₈", 600', 7⁴/₈" Roll dia., 2-Ply 6/cs.

Tork® Advanced Water Tight
 Offers these advantages. High capacity - ideal for high traffic environments. Hygienic you only touch the towel you use. Portion control, one towel every time. One hand dispensing - ideal for many environments such as workshops and kitchens. Multipurpose - highly absorbent towels for hands, surfaces and objects. Simple and reliable - low maintenance costs. Made from 100% recycled fiber. Provides environmental benefits. A positive image builder. EcoLogo® Certified. Compostable Verified by Independent Verification. Replaces 120110. 2⁹/₁₀" core dia. White.
14100105 121211 600 ct., 7¹/₁₀" x 11⁴/₈", 590', 7⁴/₈" Roll dia., 2-Ply 6/cs.

Tork® Universal
 Offer one-at-a-time service and reduced waste. High capacity reduces labor and refills. High absorbency means less towels used. Touch only dispensing towel reduces cross contamination. Made from 100% recycled fiber, providing environmental benefits. EcoLogo® Certified. 2⁹/₁₀" core dia. White.
14101932 120932 500 ct., 7³/₈" x 11⁴/₈" Sheets, 491', 7¹/₁₀" Roll dia., 2-Ply 6/cs.

Centerpull & Kitchen Roll Towels



A. CENTERPULL TOWELS SOFIDEL AMERICA

Select Choice®

This perforated two-ply centerpull towel is absorbent, strong, convenient and hygienic. Reduce the cross-over contamination by combining this towel with its hands-free dispenser. Ideal for food processing areas, healthcare, hospitality, and industrial environments. Works with dispenser DCP101-519.

57371309	31370	8 1/4" x 500', White, 2-Ply	6/cs.
57371308	31371	8 1/4" x 660', White, 2-Ply	6/cs.

Heavenly Soft®

Absorbent, strong, convenient, and hygienic. Cost effective towels are perforated to ensure one-at-a time dispensing. Ideally suited for restrooms, kitchens, break rooms, healthcare facilities, food preparation, and other areas where sanitation is important.

57370235	31235	1000 ct., 8", 1-Ply	6/cs.
57371235	31230	265 ct., 8", 2-Ply	12/cs.
57370233	31233	600 ct., 8", 2-Ply	6/cs.
57370234	31234	660 ct., 8", 2-Ply	6/cs.



B. ECOSOFT™ CENTERPULL ROLL TOWELS WAUSAU PAPER/BAY WEST

Made from high quality 100% recycled paper fiber. Features extra embossing for maximum softness and absorbency.

30036002	06002	7 3/4" x 600', White, 2-Ply	6/cs.
-----------------	-------	-----------------------------	-------



KITCHEN ROLL TOWELS

C. KITCHEN ROLL TOWELS PRIME SOURCE®

Green Source™

100% recycled. Chlorine-free. EcoLogo® Certified. Trilingual packaging (English, Spanish, French).

75009555	75009555	210 ct., 11", White, 2-Ply	12/cs.
-----------------	----------	----------------------------	--------

Prime Source®

High quality, value priced paper towel ideal for all public environments.

75004328	75004328	70 ct., 11" x 9", White, Universal, 2-Ply	30/cs.
75004327	75004327	80 ct., 11" x 9", White, Universal, 2-Ply	\$ 30/cs.
750043274	75004327	80 ct., 11" x 9", White, Universal, 2-Ply	\$ 30/cs.



D. PREFERENCE® KITCHEN ROLL TOWELS GEORGIA-PACIFIC

Popular two-ply perforated roll towels offer reliable performance for everyday cleaning and wiping tasks.

13700225	27385	85 ct., 11" x 8 1/8", White, 2-Ply	30/cs.
13707678	27300	100 ct., 11" x 8 1/8", White, 2-Ply	30/cs.
13701561	27700	250 ct., 11" x 8 1/8", White, 2-Ply	12/cs.

E. KITCHEN ROLL TOWELS KIMBERLY-CLARK

Kleenex® Premiere®

Preferred towel for softness, hand-drying and wiping power. Strong, absorbent towels with a soft feel.

15401244	13964	70 ct., 10 1/2" x 11", White	24/cs.
15403643	03405	90 ct., 10 1/2" x 11", White	12/cs.
15403405	03405	90 ct., 10 1/2" x 11", White	20/cs.

Cloth-like perforated towels are strong enough for wet scrubbing and soft enough for hand drying. Highly absorbent towels are made with Hydroknit® technology so they are woven strong.

15408125	88125	55 ct., 10 1/2" x 11", White	24/cs.
-----------------	-------	------------------------------	--------

Scott®

Scott® kitchen roll towels are soft and absorbent for excellent performance.

15400002	01482	90 ct., 11" x 9 3/8", White, 1-Ply	30/cs.
15400136	13608	96 ct., 11" x 8 7/8", White, 1-Ply	15/cs.
15401482	41482	128 ct., 11" x 8 3/4", White, 1-Ply	20/cs.
15403609	39109	180 ct., 11" x 9 3/8", White, 1-Ply	15/cs.





Kitchen Roll Towels

PAPER PRODUCTS



A. HOUSEHOLD TOWELS MARCAL PAPER MILLS

Small Steps Giant Size

Perforated roll towel. 100% recycled. Whitened without chlorine bleaching. Hypoallergenic. Virtually lint-free. No dye or fragrance.

15700005 6183 150 ct., 11" x 5 7/10" White, 2-Ply 12/cs.

Small Steps® 100% Premium Recycled Perforated

Made with a minimum of 60% post consumer content. Meets or exceeds EPA guidelines for post consumer content. 15 individually wrapped rolls per carton. Great for small to midsize offices. Strong and absorbent premium recycled towels. Whitened without chlorine bleaching. No dye or fragrance added. Virtually lint-free.

15706711 6709 60 ct., 11" x 9", White, Carton, 2-Ply 15/cs.

Sunrise®

Quilted embossing adds to its quick and thorough absorbing power. Sunrise® roll towels are free from any inks making these towels perfect for any clean-up job. 100% recycled.

Whitened without chlorine bleaching. Hypoallergenic. Virtually lint-free. No dye or fragrance.

15700630 630 60 ct., 11" x 9", White, Corrugated Carton, 2-Ply 30/cs.

15700610 610 60 ct., 11" x 9", White, Poly Bundle, 2-Ply 15/cs.

B. ROLL PAPER TOWELS PROCTER & GAMBLE

Bounty® Basic

Strong and absorbent, and a great value too. Has a honeycomb texture for strength. Just right for all your everyday paper towel jobs.

16908318 28318 52 ct., 10 2/5" x 11", White, 1-Ply 30/cs.

16900135 28322 52 ct., 11" x 11", White, 1-Ply 12/cs.

Bounty®

Perforated roll paper towels are strong and quick absorbing even when wet.

16900289 81461 48 ct., 10 2/5" x 11", White, 2-Ply 15/cs.

16900286 81539 48 ct., 11" x 11", White, Regular, 2-Ply 30/cs.



C. TORK® ADVANCED PERFORATED ROLL TOWELS SCA TISSUE

Tork® Advanced

Tork® Advanced perforated roll towels have high-bulk, two-ply construction that maximizes absorbency for superior spill holding power using fewer towels. Super strong soft towels hold together even on tough jobs. Ideal for cleaning and wiping all surfaces. Made from 100% recycled fibers has environmental benefits and is a positive image builder. EcoLogo® Certified.

14100107 HB9201 120 ct., 11"W x 6 3/4"L, 5 1/2" Roll dia., White, 2-Ply 30/cs.

Tork® Universal

Tork® Universal perforated roll towels have high-bulk, two-ply construction that maximizes absorbency for superior spill holding power using fewer towels. Super strong soft towels hold together even on tough jobs. Ideal for cleaning and wiping all surfaces. Made from 100% recycled fiber. EcoLogo® Certified.

14100122 HB1990A 84 ct., 9" x 11", White, 2-Ply 30/cs.

14101996 HB1995A 210 ct., 9" x 11", White, 2-Ply 12/cs.

Tork® Universal perforated roll towels have high-bulk, two-ply construction that maximizes absorbency for superior spill holding power using fewer towels. Super strong soft towels hold together even on tough jobs. Ideal for cleaning and wiping all surfaces. 210 count gives you twice the toweling, reducing replacement time, helps eliminate run-out and saves storage and delivery costs. Made from 100% recycled and meets the EPA compliant (minimum 90% Post Consumer Content) providing environmental benefits. A positive image builder. EcoLogo® and Green Seal™ Certified.

14101975 HK1975A 210 ct., 11" x 9", Natural, 2-Ply 12/cs.



Kitchen Roll & C-Fold Towels



A. KITCHEN ROLL TOWELS SOFIDEL AMERICA

Heavenly Soft®

Made from natural fibers, these two-ply kitchen roll towels have a proprietary embossing pattern. Soft, strong, and absorbent. Very reliable. For every day cleaning and wiping tasks. Individually wrapped.

57379180	52231	85 ct., 11" x 8 ¹ / ₅ ", White, 2-Ply	30/cs.
57372334	52233	250 ct., 11" x 7 ⁹ / ₁₀ ", White, 2-Ply	12/cs.

Select Choice

Made from natural fibers, the two-ply kitchen roll has a proprietary embossing pattern making this towel soft, strong and absorbent. A very reliable towel for every day cleaning and wiping tasks. Individually wrapped. Ideal for cleaning and wiping in healthcare, laboratories, clinic, salons and other facilities. A great product for maintenance supply, discounts, cash-and-carry stores and supermarkets.

57371310	KRT85	85 ct., White, 2-Ply	30/cs.
57371373	41373	750', Bleached	6/cs.



B. ECOSOFT™ HOUSEHOLD PAPER TOWELS WAUSAU PAPER/BAY WEST

EcoSoft™

EcoSoft™ household toweling is 100% recycled and contains a minimum of 40% post-consumer waste, which meets EPA guidelines. This household toweling is heavily embossed for maximum absorbency and performance, with the wet strength needed for use in business and industry.

30030110	41000	90 ct., 11" x 9", White, 2-Ply	30/cs.
-----------------	-------	--------------------------------	--------

EcoSoft™ Green Seal™

Household roll towels that are heavily embossed for superior absorbency and performance. This toweling has the wet strength needed for use in business and industry. EcoSoft™ Green Seal™ household toweling is certified as environmentally preferable by Green Seal, Inc. of Washington, DC.

30031090	41090	90 ct., 11" x 9", White, 2-Ply	30/cs.
-----------------	-------	--------------------------------	--------



C-FOLD TOWELS

C. PRIME SOURCE® C-FOLD TOWELS PRIME SOURCE®

High quality, value priced paper towel ideal for all public environments.

75004312	75004312	150 ct., 10 ¹ / ₄ " x 13", Natural	2400/cs.
75004304	75004304	150 ct., 10 ¹ / ₄ " x 13", White	2400/cs.
750043044	75004304	150 ct., 10 ¹ / ₄ " x 13", White	2400/cs.

D. HI-VALU C-FOLD TOWELS HI-VALU

High quality and value priced. Ideal for all public environments.

73004304	73004304	150 ct., 10 ¹ / ₄ " x 13"	2400/cs.
-----------------	----------	---	----------

E. C-FOLD TOWELS GEORGIA-PACIFIC

Acclaim®

Economy C-fold towels for reliable performance at a low cost. Designed to fit into a wide range of appropriate dispensers. Folded width: 3¹/₄".

13707622	20603	240 ct., 10 ¹ / ₄ " x 13 ³ / ₄ ", White	2400/cs.
-----------------	-------	---	----------

Preference®

One-ply, near premium C-fold towels.

13702041	20241	200 ct., 10 ¹ / ₄ " x 13 ³ / ₄ ", White, 1-Ply	12/cs.
-----------------	-------	--	--------

Signature®

These premium C-fold towels feature a patented honeycomb emboss that adds a touch of elegance to any washroom, while two thick and thirsty plies offer super absorbency with every hand dry. Folded width: 3⁵/₈".

13700176	23000	120 ct., 10 ¹ / ₄ " x 13 ³ / ₄ ", White, 2-Ply	1440/cs.
-----------------	-------	--	----------





C-Fold Towels



A. C-FOLD TOWELS KIMBERLY-CLARK

Kleenex®
 Dependable, folded towels that you can look to for softness, absorbency and performance. FSC Certified.

15401500	<i>01500</i>	150 ct., 10 ¹ / ₈ " x 13 ¹ / ₈ ", White, 1-Ply	2400/cs.
15400059	<i>88115</i>	150 ct., 10 ¹ / ₈ " x 13 ¹ / ₈ ", White, 1-Ply, Office Pack	4/150/cs.

Scott®
 Depend on these for reliable performance. Fits dispensers 09008, 09009, 09905, 09906, 09952 and 09976.

15401510	<i>01510</i>	150 ct., 10 ¹ / ₈ " x 13 ¹ / ₈ ", White, 1-Ply	2400/cs.
-----------------	--------------	--	----------

Scott® 100% RF
 Made with 100% recycled fiber. Meets EPA standards for 40% minimum post-consumer waste content. Green Seal™ Certified.

15402921	<i>02920</i>	200 ct., 10 ¹ / ₁₀ " x 13 ¹ / ₈ ", White, 1-Ply	2400/cs.
-----------------	--------------	---	----------

Scott® Select®
 C-fold towels.

15403623	<i>03623</i>	150 ct., 13 ¹ / ₃ " x 10 ² / ₅ ", White	1800/cs.
-----------------	--------------	---	----------

Tradition™
 This one-ply towel is suitable for most anywhere. These towels are among our most popular choice in folded towels.

15404140	<i>0292050</i>	150 ct., 13" x 10 ¹ / ₄ ", White, 1-Ply	2400/cs.
-----------------	----------------	---	----------



B. C-FOLD TOWELS SCA TISSUE

Tork® Advanced
 Soft and absorbent towels offer the perfect combination of quality, performance and value. Embossing enhances hand feel and maximum absorbency. High wet strength designed to please your most demanding users. Improved product design helps to control usage, so you save on reduced waste and maintenance time. Made from 100% recycled fiber. Provides environmental benefits. A positive image builder. EcoLogo® Certified. Compostable Verified by Independent Verification.

14100700	<i>CB520</i>	150 ct., 12 ¹ / ₅ " x 10 ¹ / ₈ ", White, 1-Ply	2400/cs.
-----------------	--------------	--	----------

Tork® Premium
 Soft and absorbent C-fold towels offer the perfect combination of quality, performance and value. High wet strength designed to please your most demanding users. Improved product design helps to control usage, so you save on reduced waste and maintenance time. 1-Ply.

14101540	<i>CB510</i>	125 ct., 12 ³ / ₄ " x 10 ¹ / ₈ ", 3 ¹⁹ / ₂₀ " x 10 ¹ / ₈ " Folded, White	2400/cs.
-----------------	--------------	--	----------

Tork® Universal
 Soft and absorbent towels offer the perfect combination of quality, performance and value. Embossing enhances hand feel and maximum absorbency. High wet strength designed to please your most demanding users. Improved product design helps to control usage, so you save on reduced waste and maintenance time. Made from 100% recycled fiber. Provides environmental benefits. A positive image builder. EcoLogo® Certified. Compostable Verified by Independent Verification. 1-Ply.

14100706	<i>CB530</i>	150 ct., 12 ³ / ₄ " x 10 ¹ / ₈ ", 3 ¹⁹ / ₂₀ " x 10 ¹ / ₈ " Folded, White	2400/cs.
-----------------	--------------	--	----------



C. C-FOLD TOWELS WAUSAU PAPER/BAY WEST

DublSoft®
 Premium DublSoft® folded towels absorb wetness quickly, reducing the number of towels needed per hand dry.

30030047	<i>DS49</i>	200 ct., 10 ¹ / ₈ " x 13", White	2400/cs.
-----------------	-------------	--	----------

EcoSoft™
 EcoSoft™ folded towels are made of 100% recycled fibers and contain a minimum of 40% post-consumer waste, which meets EPA guidelines.

30030217	<i>49500</i>	150 ct., 10 ¹ / ₈ " x 13", White	2400/cs.
-----------------	--------------	--	----------

EcoSoft™ Green Seal™
 EcoSoft™ Green Seal™ folded towels are 100% recycled and made entirely from recovered fibers. Natural towels contain up to 82% post-consumer waste and natural white towels contain up to 73% post-consumer waste.

30030493	<i>49300</i>	150 ct., 10 ¹ / ₈ " x 13", Natural White	2400/cs.
-----------------	--------------	--	----------

Multifold Towels



MULTIFOLD TOWELS

A. MULTIFOLD TOWELS

PRIME SOURCE®

Green Source™

100% recycled. Chlorine-free. EcoLogo® Certified. Trilingual packaging (English, Spanish, French).

75009515	<i>75009515</i>	8 1/8" x 9 1/2", Natural, 1-Ply	4000/cs.
75009510	<i>75009510</i>	8 1/8" x 9 1/2", White, 1-Ply	4000/cs.

Prime Source®

High quality, value priced paper towel ideal for all public environments.

75004307	<i>75004307</i>	200 ct., 9 1/8" x 9 1/2", Natural	4000/cs.
750043074	<i>75004307</i>	200 ct., 9 1/8" x 9 1/2", Natural	4000/cs.
75004306	<i>75004306</i>	200 ct., 9 1/8" x 9 1/2", White	20/200/cs.
750043064	<i>75004306</i>	200 ct., 9 1/8" x 9 1/2", White	4000/cs.



B. HI-VALU MULTIFOLD TOWELS

HI-VALU

Universal paper towel are high quality and value priced. Ideal for all public environments.

73004307	<i>73004307</i>	200 ct., 9 1/4" x 9 1/2", Natural	4000/cs.
73004306	<i>73004306</i>	200 ct., 9 1/4" x 9 1/2", White	4000/cs.



C. MULTIFOLD TOWELS

GEORGIA-PACIFIC

Acclaim®

Economy white multifold towels for reliable performance at a low cost.

13707630	<i>20204</i>	250 ct., 9 1/4" x 9 1/2", 3 1/4" Folded, White	16/250/cs.
-----------------	--------------	--	------------

Bigfold Z®

Premium towels with a new emboss that fits into existing C-fold and multifold dispensers (with no adapter required) to provide a premium, cost-saving C-fold substitute. Unique fold allows for reliable, one-at-a-time touchless dispensing which reduces the number of towels used as well as the risk of cross-contamination.

13700886	<i>20887</i>	220 ct., 10 1/4" x 11", White, 1-Ply	2200/cs.
-----------------	--------------	--------------------------------------	----------

Envision®

Economical, EPA compliant multifold towels for reliable performance at a low cost.

13700233	<i>23304</i>	250 ct., 9 1/4" x 9 1/2", Brown, 1-Ply	4000/cs.
-----------------	--------------	--	----------

Signature®

Premium multifold hand towels provide softness and absorbency. Patented honeycomb pattern creates thick, luxurious softness.

13700218	<i>21000</i>	125 ct., 9 1/4" x 9 1/2", White, Folded Width: 3 1/4", 2-Ply	2000/cs.
-----------------	--------------	--	----------



D. GUEST TOWELS

HOFFMASTER

Linen-Like®

Dress up your restroom countertops with Linen-Like® guest towels. Your patrons will appreciate this soft absorbent product versus the standard paper towel.

17803812	<i>856499</i>	100 ct., 12" x 17", White	500/cs.
-----------------	---------------	---------------------------	---------

Linensaver

Guest towels.

18101716	<i>SL131716</i>	125 ct., 15" x 17", 1/8 Fold	500/cs.
-----------------	-----------------	------------------------------	---------



E. MULTIFOLD TOWELS

KIMBERLY-CLARK

Kleenex®

Premium towels set the standard for softness and absorbency; plus they will help reduce cost since fewer towels are needed per use.

15409040	<i>01890</i>	150 ct., 9 1/8" x 9 1/2", White, 1-Ply	2400/cs.
15404600	<i>0204600</i>	150 ct., 9 1/8" x 9 1/2", White, 1-Ply	8/cs.
15408130	<i>88130</i>	150 ct., 9 1/4" x 9 1/2", White, 1-Ply	4/cs.

Kleenex® Scottfold®

Made to eliminate dispensing problems. Designed to dispense one-at-a-time, every time. Virtually eliminate tear-out and messy towel litter. Zip-Half Pack cases. Meet EPA standards with a minimum of 40% post-consumer waste.

15401900	<i>01900</i>	120 ct., 8 1/10" x 12 2/5", White	2400/cs.
15403253	<i>13253</i>	120 ct., 8 1/10" x 12 2/5", White	3000/cs.
15401999	<i>01999</i>	120 ct., 9 2/5" x 12 2/5", White	1920/cs.
15403254	<i>13254</i>	120 ct., 9 2/5" x 12 2/5", White	3000/cs.





Multifold Towels



A. MULTIFOLD TOWELS (CONT.) KIMBERLY-CLARK

Kleenex® Slimfold

The unique design of Kleenex® Slimfold fits the tightest spaces inside or outside of the washroom. One-at-a-time dispensing reduces waste. Exclusive absorbency pockets provide excellent absorbency and hand-drying performance in an environmentally sound product. Meets EPA standards for minimum post-consumer waste. FSC certified. Content: 60% recycled fiber, 40% post consumer waste.

1540442 04442 90 ct., 7 1/2" x 11 3/5", White 2160/cs.

Scott®

Design allows for towels to dispense one-at-a-time for less waste, more value and a tidier washroom.

15400450 01804 250 ct., 9 1/4" x 9 2/5", White, 1-Ply 4000/cs.

Scott® 100% RF

Made with 100% recycled fiber. Meets EPA standards for 40% minimum post-consumer waste content. Green Seal™ Certified.

15401801 01801 250 ct., 9 1/5" x 9 2/5", Natural, 1-Ply 4000/cs.

15401807 01807 250 ct., 9 1/5" x 9 2/5", White, 1-Ply 4000/cs.

Scott® Scottfold®

Larger case size to reduce packaging waste; meets EPA standards with a minimum of 40% post-consumer recycled fiber and total minimum of 50% recycled fiber. The ideal replacement for C-folds. Dispenses one-at-a-time. Eliminates tabbing and tearing and easy-to-load. We guarantee 10% cost savings versus C-fold towels.

15401960 01960 175 ct., 8 1/10" x 12 2/5", White, 1-Ply 4375/cs.

15401970 01970 175 ct., 9 2/5" x 12 2/5", White 3500/cs.

15401980 01980 175 ct., 9 2/5" x 12 2/5", White, 1-Ply 4375/cs.

Tradition®

Design allows for towels to dispense one-at-a-time for less waste, more value and a tidier washroom.

15400026 01840 250 ct., 9 2/5" x 9 1/4", White, 1-Ply 3000/cs.

15401815 01840 250 ct., 9 2/5" x 9 1/4", White, 1-Ply 4000/cs.

B. ROSES MULTIFOLD TOWELS ROSES SOUTHWEST PAPER

Multifold towels.

59340203 203R 250 ct., 9 2/5" x 9 1/5", Bleached, 1-Ply 4000/cs.

59340202 202R 250 ct., 9 2/5" x 9 1/5", Natural, 1-Ply 4000/cs.

C. MULTIFOLD TOWELS SCA TISSUE

Tork® Advanced

The unique three panel interfolded system, creates ready-to-use towels with no towel "Fall Out". Portion control, delivers one towel every time. Tork® Advanced Xpress™ towels are easy to refill, reducing maintenance time and costs. Towels are made from 100% recycled fibers (EPA compliant) providing environmental benefits. A positive image builder. EcoLogo® Certified.

14101291 101291 144 ct., 8 9/10" x 10", 8 9/10" x 3 3/8" Folded, 2-Ply 3024/cs.

Soft and absorbent towels provide the right combination of quality, performance and value.

Embossing enhances hand feel and maximum performance. Made from 100% recycled fibers. High wet strength provides a premium quality people appreciate. Fast absorbency helps to control usage, so you save on reduced waste and maintenance time. "No touch" hand towel service offers sanitary conditions. Made from 100% recycled fibers, providing environmental benefits. A positive image builder. EcoLogo® Certified.

14100551 MB550A 250 ct., 9 1/2" x 9 1/8", White, 1-Ply 4000/cs.

Soft and absorbent towels provide a premium quality people appreciate. Multifold design provides for less towel consumption leading to source reduction, storage space savings, and lower overall costs. Deep embossing enhances hand feel and maximum absorbency.

Excellent wet strength designed to please your most demanding users. Speedy absorbency helps to control usage, so you save on reduced waste and maintenance time. "No touch" hand towel service offers sanitary conditions. Towels are made from 100% recycled fibers and 40% Post Consumer fibers providing environmental benefits. A positive image builder. Replaces MB560. EcoLogo® and Green Seal™ Certified.

14100550 MB560A 150 ct., 9 1/2" x 9 1/8", 3 1/5" x 9 1/8" Folded, White, 1-Ply 2400/cs.

Multifold Towels



A. MULTIFOLD TOWELS (CONT.)

SCA TISSUE

Tork® Premium

Tork® Premium ultra soft and absorbent towels provide a premium quality people appreciate. Multifold design provides for less towel consumption leading to source reduction, storage space savings, and lower overall costs. Excellent wet strength designed to please your most demanding users. Speedy absorbency helps to control usage, so you save on reduced waste and maintenance time. "No touch" hand towel service offers sanitary conditions.

EcoLogo® Certified.

14100575 MB570 250 ct., 9 1/2" x 9 1/8", 3 1/5" x 9 1/8" Folded, White, 1-Ply 2400/cs.

Tork® Universal

Innovative towel service surpasses all other folded towel services in performance, value, and economy. Multifold design helps to minimize towel usage. Towels are made from 100% recycled fibers. EcoLogo® Certified.

14100553 MK518A 250 ct., 9 1/2" x 8 1/10", 3 1/5" Folded, Natural, 1-Ply, 4000/cs.
Green Seal™ Certified

14100520 MK520A 250 ct., 9 1/2" x 9 1/8", 3 1/5" Folded, Natural, 1-Ply, 4000/cs.
Green Seal™ Certified

14100538 MB540A 250 ct., 9 1/2" x 9 1/8", 3 1/5" Folded, White, 1-Ply 4000/cs.

Soft and absorbent towels provide the right combination of quality, performance and value. Embossing enhances hand feel and maximum performance. Made from 100% recycled fibers. EcoLogo® Certified.

14100552 MK530A 250 ct., 9 1/2" x 9 1/8", Natural, 1-Ply 4000/cs.



B. HEAVENLY SOFT® MULTIFOLD TOWELS

SOFIDEL AMERICA

This individual multifold towel offers reliable performance at a low cost. Made from 100% recycled paper. Get maximum absorbency in an economical easy-to-dispense towel. Fits a wide range of folded towel dispensers.

57371231 61231 250 ct., 9 1/4" x 9 1/2", Bleached, 1-Ply 4000/cs.

57371229 61230 250 ct., 9 1/4" x 9 1/2", Natural, 1-Ply 4000/cs.



C. MULTIFOLD TOWELS

WAUSAU PAPER/BAY WEST

Dubl-Nature® Optifold®

A premium alternative to traditional folded towels. Made from a superior grade of 100% recycled paper and contain up to 43% post-consumer waste content. Attractive "leaf" embossing. Exceptional brightness and absorbency. Green Seal™ Certified.

30030028 48490 250 ct., 10 1/4" x 9 1/2", White 3000/cs.

DublSoft®

Premium DublSoft® folded towels absorb wetness quickly, reducing the number of towels needed per hand dry.

30030048 DS48 250 ct., 9 1/8" x 9 1/2", White 3000/cs.

DublSoft® Optifold®

A premium alternative to traditional folded towels. Features exclusive leaf embossing pattern. Offers maximum softness, strength and absorbency.

30030488 00488 250 ct., 10 1/4" x 9 1/2", White 3000/cs.

EcoSoft™

EcoSoft™ folded towels are made of 100% recycled fibers and contain a minimum of 40% post-consumer waste, which meets EPA guidelines.

30030004 48000 200 ct., 9 1/8" x 9 1/2", Natural 4000/cs.

30030005 48500 200 ct., 9 1/8" x 9 1/2", White 4000/cs.

EcoSoft™ Green Seal™

EcoSoft™ Green Seal™ folded towels are 100% recycled and made entirely from recovered fibers. Natural towels contain up to 82% post-consumer waste and natural white towels contain up to 73% post-consumer waste.

30030483 48300 200 ct., 9 1/8" x 9 1/2", Natural White 4000/cs.





Singlefold & Windshield Towels

PAPER PRODUCTS

SINGLEFOLD TOWELS



A. PRIME SOURCE® SINGLEFOLD TOWELS PRIME SOURCE®

High quality, value priced paper towel ideal for all public environments.

75004301	75004301	268 ct., 9 ¹ / ₈ " x 10 ¹ / ₄ ", Natural	4000/cs.
750043014	75004301	268 ct., 9 ³ / ₁₀ " x 10 ¹ / ₂ ", Natural	4000/cs.
750043013	75004301	268 ct., 9 ³ / ₁₀ " x 10 ¹ / ₂ ", Natural	4000/cs.
75004302	75004302	268 ct., 9 ¹ / ₈ " x 10 ¹ / ₄ ", White	4000/cs.
750043024	75004302	268 ct., 9 ³ / ₁₀ " x 10 ¹ / ₂ ", White	4000/cs.



B. SINGLEFOLD TOWELS GEORGIA-PACIFIC

Acclaim®
Economy singlefold towels for reliable performance at a low cost. Folded: 5⁷/₁₆"W.

13707616	23504	250 ct., 9 ¹ / ₂ " x 10 ⁵ / ₈ ", Brown, 1-Ply	4000/cs.
----------	-------	---	----------

Preference®
Embossed design and added thickness deliver absorbency customers will appreciate. Mid range sheet engineered for good quality and good value. Corrugate box makes for more efficient loading and unloading as well as storage. Folded: 5⁷/₁₆"W.

13700788	2078601	250 ct., 9 ¹ / ₄ " x 10 ¹ / ₄ ", White, 1-Ply	4008/cs.
----------	---------	---	----------



C. SCOTT® SINGLEFOLD TOWELS KIMBERLY-CLARK

Tailored for areas where function is just as important as quality.

15401700	01700	250 ct., 10 ¹ / ₂ " x 9 ¹ / ₃ ", White	4000/cs.
----------	-------	--	----------



D. TORK® UNIVERSAL SINGLEFOLD TOWELS SCA TISSUE

Soft and absorbent towels provide the right combination of quality, performance and value. Embossing enhances hand feel and maximum performance. Singlefold design provides quality people appreciate while working to reduce your overall costs. Fits all standard singlefold towel dispensers. Second fold creates a second 1/2" tab to aid dispensing. Made from 100% recycled fibers, providing environmental benefits. A positive image builder. EcoLogo® Certified.

14101855	SK1850A	250 ct., 10 ¹ / ₄ " x 9 ¹ / ₈ ", Natural	4000/cs.
14101841	SB1840A	250 ct., 10 ¹ / ₄ " x 9 ¹ / ₄ ", White	4000/cs.



E. SINGLEFOLD TOWELS WAUSAU PAPER/BAY WEST

EcoSoft™
EcoSoft™ folded towels are made of 100% recycled fibers and contain a minimum of 40% post-consumer waste, which meets EPA guidelines.

30030090	47000	268 ct., 9" x 10", Natural	4020/cs.
30030092	47500	268 ct., 9" x 10", White	4020/cs.

EcoSoft™ Green Seal™
EcoSoft™ Green Seal™ folded towels are 100% recycled and made entirely from recovered fibers. Natural towels contain up to 82% post-consumer waste and natural white towels contain up to 73% post-consumer waste.

30030091	47300	268 ct., 9" x 10", Natural White	4020/cs.
----------	-------	----------------------------------	----------



WINDSHIELD TOWELS

F. INTERSTATE® PAPER WIPERS GEORGIA-PACIFIC

Economical, one-ply blue windshield and auto care disposable towels.

13701235	02350	188 ct., 9 ¹ / ₂ " x 10 ¹ / ₄ ", Blue, 1-Ply	2250/cs.
----------	-------	--	----------



G. WYPALL® L10 WINDSHIELD TOWELS KIMBERLY-CLARK

Improved for better cleaning performance. Extra strength and special textured surface.

15405123	05123	224 ct., 9 ¹ / ₁₀ " x 10 ¹ / ₄ ", Blue	10/224/cs.
15405120	05123	224 ct., 9 ¹ / ₁₀ " x 10 ¹ / ₄ ", Blue	16/140/cs.

Windshield Towels/Roll Towel Dispensers



A. TORK® UNIVERSAL WINDSHIELD TOWELS SCA TISSUE

Soft, absorbent and strong windshield towels provide maximum absorption in a variety of climates and conditions. Singlefold design fits all the standard dispensers. Contains 100% recycled fibers.

14102121	192121	250 ct., 9 ⁷ / ₈ " x 10 ¹ / ₄ ", Blue, 1-Ply	2250/cs.
14102122	192122	140 ct., 9 ⁷ / ₈ " x 10 ¹ / ₄ ", Blue, 2-Ply	2240/cs.



ROLL TOWEL DISPENSERS

B. PRIME SOURCE® HANDS-FREE TOWEL DISPENSER PRIME SOURCE®

Translucent black towel dispenser.

75004345	75004345	11 ¹ / ₁₆ " x 16 ¹ / ₁₆ " x 9 ⁷ / ₁₆ ", Black Translucent	1/ea.
----------	----------	---	-------

C. PRIME SOURCE® ROLL TOWEL DISPENSERS PRIME SOURCE®

Translucent black towel dispenser.

75004335	75004335	11 ¹ / ₂ " x 15 ¹ / ₈ " x 10 ¹ / ₂ ", Black Translucent, Button Lever	1/ea.
750043391	75004339	11 ¹ / ₂ " x 15 ¹ / ₈ " x 10 ¹ / ₂ ", Black Translucent, Lever	1/ea.
75004339	75004339	11 ¹ / ₂ " x 15 ¹ / ₈ " x 10 ¹ / ₂ ", Black Translucent, Lever	40/cs.
75004336	75004336	Black Translucent, Mechanical, Hands-Free	1/ea.



D. PRIME SOURCE® WAVE 'N DRY ROLL TOWEL DISPENSERS PRIME SOURCE®

The first roll towel system to offer totally touch-free dispensing. The towel is stored fully protected inside the dispenser until you request service by passing your hand or arm near the sensor. There are no levers, buttons, or cranks to touch.

75004341	75004341	12" x 15 ⁷ / ₈ " x 10 ³ / ₈ ", Black Translucent	1/ea.
75004348	75004348	Black Translucent	1/ea.
75004378	75004378	White	1/ea.



E. IN-SIGHT SERIES-I LEV-R-MATIC® ROLL TOWEL DISPENSER KIMBERLY-CLARK

New curved silhouette adds aesthetic appeal. Made of high-impact plastic with a smoked transparent cover. Easy roll loading and automatic sheet feed. Dispenses one 8" roll and one 3¹/₂" dia. roll with 1¹/₂" dia. cores. Features a metal key operated lock, optional user installed knob (for lock operation), lever operated dispensing mechanism and stub roll.

15409765	09765	13 ³ / ₈ "W x 13 ¹ / ₂ "H x 9 ⁵ / ₈ "D, Smoke Gray	1/ea.
----------	-------	--	-------



F. IN-SIGHT® LEV-R-MATIC® II ROLL TOWEL DISPENSER KIMBERLY-CLARK

Translucent, smoked plastic design allows you to see inside so you know exactly when a refill is needed, without having to open the dispenser. Compact size. Economical frill-free design.

15400391	09736	10 ³ / ₄ " x 13 ³ / ₄ " x 9 ⁵ / ₈ ", Smoke	1/ea.
----------	-------	--	-------



G. IN-SIGHT® SANITOUCH® HARD ROLL TOWEL DISPENSER KIMBERLY-CLARK

Better stub roll feature. Quieter sound. Easier to see tail of paper. Shorter sheet size for better economy.

15409990	09990	12 ² / ₈ " x 16 ¹ / ₈ " x 10 ¹ / ₈ ", Smoke	1/ea.
----------	-------	---	-------



H. LEVER-ACTION ROLL TOWEL DISPENSER & HRT STARTER KIT KIMBERLY-CLARK

Includes one towel dispenser and one non-perforated roll of towels.

15408076	08076		1/ea.
----------	-------	--	-------



PAPER PRODUCTS



Roll Towel Dispensers

PAPER PRODUCTS



A. INTEGRA™ ROLL TOWEL DISPENSER **SAN JAMAR**
 Universal dispenser works with any brand or quality of hardwound roll towels. Easy-to-load and dispenses with simple push of lever. Break-resistant plastic construction.
62570850 T850TBK 13½"H x 11½"W x 11¼"D, Black Pearl 1/ea.



B. JAZ ROLL TOWEL DISPENSER **SAN JAMAR**
 Intended for employee use. Contemporary, non-portioned controlled dispenser allows for quick and easy clean ups. Patented tooth pattern allows for easy tearing of the towel. High-impact plastic construction. Holds one 8" wide roll.
62570751 T750 9¾" x 12" x 12¾", Pearl White 1/ea.



C. LEVER ROLL TOWEL DISPENSER **SAN JAMAR**
 Larger capacity dispenser reduces maintenance costs with longer intervals between refills. Bio-Pruf™ treated handle resists bacterial growth. Universal to work with all types of roll towels. Made of break-resistant plastic. Capacity: one 8"W x 8½" dia. roll and up to 4" stub roll.
62570096 T1100TBK 16½"H x 12½"W x 9¼"D, Black Pearl 1/ea.



D. SAVVY™ UNIVERSAL LEVER ROLL TOWEL DISPENSER **SAN JAMAR**
 Aesthetically pleasing and operationally functional in any washroom environment. Universal and dispenses any quality of paper. Continual availability of paper is provided by the Infinity® System automatic transfer, eliminating stub roll waste. Break-resistant plastic.
62571292 T1200TBK 16½" x 12½" x 9¼", Black Pearl 1/ea.



E. SMART SYSTEM WITH IQ SENSOR™ TOUCHLESS ROLL TOWEL DISPENSER **SAN JAMAR**
 Offers the versatility and reliability of the Smart System with the added features of the IQ Sensor™. Holds one 8" wide x 8" dia. roll and one 4" stub roll. Dual mode - sensor mode and paper out. Consistent performance throughout the battery's entire lifespan. Infinity® System auto transfer to eliminate stub roll waste.
62571480 T1400TBK 16½"H x 11¾"W x 9¼"D, Black Pearl 1/ea.



F. TEAR-N-DRY™ ELECTRONIC TOUCHLESS ROLL TOWEL DISPENSER **SAN JAMAR**
 A simple hands-free alternative. Provides 10" paper portions every time without a wait. Because there is no need to wait for a sensor this dispenser is ideal for high traffic areas. Has the longest battery life in the industry, requiring less maintenance. No adjustments needed; just mount and go. Holds one 8" wide roll; 8½" dia. and one 4" stub roll.
62571300 T1300TBK 16½"H x 11¾"W x 9¼"D, Black Pearl 1/ea.



G. TORK® ELEVATION Matic® HAND TOWEL ROLL DISPENSERS **SCA TISSUE**
 Tork® Elevation dispensers simplify and complement any environment, providing a clean, hygienic appearance. The design ensures easy and intuitive maintenance, refilling and use. High capacity dispenser is ideal for busy washrooms. Hands-free dispensing provides a hygienic, one-at-a-time solution for your washroom. The user touches only the towel needed, reducing the risk of cross-contamination. Semi-transparent cover makes it easy-to-see when a refill is needed. Push bar for loading and emergency feeds. Utilizes any Tork® H1 Roll Towel.
14100421 551028A 13⅓"W x 14⅞"H x 8"D, H1 System, Black 1/ea.
14100420 551020A 13⅓"W x 14⅞"H x 8"D, H1 System, White 1/ea.

Roll & Centerpull Towel Dispensers



A. TORK® HAND TOWEL ROLL DISPENSER SCA TISSUE

Translucent cover allows for "at a glance" inspection for refills. Smooth cover with no recesses is easy-to-clean and maintain. Lever controlled consumption means less waste, lower costs. Stub roll auto-transfer feature, built-in pilferage control. High impact plastic and design help prevent breakage. Lever auto transfer.

14102084 84TR 15¹/₂"H x 12⁵/₁₆"W x 9¹/₄"D, 1 Roll, Smoke 1/ea.



B. TORK® INTUITION HAND TOWEL ROLL DISPENSERS SCA TISSUE

The touch-free electronic Tork® Intuition virtually eliminates cross contamination while cutting back on supply waste. Each unit features a choice of two dispensing modes. The sensor mode, in which the towel remains inside the cabinet until the user activates the sensor delivers maximum hygiene. The hanging mode, in which a single towel is exposed for immediate access, is ideal for high-traffic venues. An adjustable towel length of 8" to 24", an adjustable time delay of less than one second to over four seconds, and a stub roll compartment combine to deliver more precise control of consumption. See-through window shows when it's time to re-fill, saving maintenance time. Long battery life. Simple to reload. Versatile, can be mounted directly to wall or within a recessed compartment. Numerous back-plate mounting slots fit most any pattern. Utilizes Tork® Towels - smart solution one paper SKU - any Tork® roll towel fits into Tork® Intuition Dispensers for automatic hands-free Tork® dispensing. Uses three D size batteries.

14109609 309609A 14¹/₂"H x 12¹/₄"W x 8¹/₈"D, Black 1/ea.

14109606 309606 14¹/₂"H x 12¹/₄"W x 8¹/₈"D, White 1/ea.



C. SILHOUETTE® OPTISERV® HANDS-FREE ROLL TOWEL DISPENSER WAUSAU PAPER/BAY WEST

This hands-free dispenser only requires you to touch your personal towel, reducing the chance for cross-contamination from touching commonly used surfaces such as levers or buttons. Ideal for food preparation and healthcare environments. Accommodates up to an 800' roll along with a 4" stub roll to optimize dispenser capacity and save maintenance time. With each pull of the slightly exposed towel, the OptiServ™ dispenses and cuts a pre-measured 11" towel for maximum usage control. ADA compliant when installed according to the Guidelines for Accessible Design. Side-hinged door for ease when opening and loading the dispenser. Supports the principles of HACCP.

30036531 86500 11¹/₁₆" x 16¹/₁₆" x 9⁷/₁₆", Black Translucent 1/ea.



CENTERPULL TOWEL DISPENSERS

D. IN-SIGHT® ROLL CONTROL CENTERPULL TOWEL DISPENSER KIMBERLY-CLARK

In-Sight® roll control dispensers with the Scott® roll control centerpull towels introduce a center-flow system that reduces dispensing problems (streaming, lost tail, crumpled sheet appearance). Our system also provides more hand driers per case than singlefold, C-fold, and M-fold towels to make it economical and very effective for hand drying needs.

15409989 09989 10¹/₄" x 11⁷/₈" x 9¹/₄", Smoke Gray 1/ea.



E. TORK® ELEVATION CENTERFEED PRO DISPENSER SCA TISSUE

Tork® Elevation dispensers simplify and complement any environment, providing a clean, hygienic appearance. Design ensures easy and intuitive maintenance, refilling and use. The Tork® Centerfeed Pro Dispensing Systems enable an easy, one-handed operation and controlled consumption with the enhanced pro feature. The ideal systems for areas where hand and light surface wiping are combined. Tork® Centerfeed Pro high capacity cabinets are ideal for high traffic environments. Cabinets are hygienic. You only touch the towel you use. No cross contamination from levers or cranks. Portion control feature dispenses one towel every time. Cabinets are simple and reliable offering low maintenance costs. Replaces 302092 and 302282.

14102092 559028A 9²/₅"W x 14²/₅"H x 9"D, Black 1/ea.

14100434 559020A 9²/₅"W x 14²/₅"H x 9"D, White 1/ea.





Centerpull, C-Fold/Multifold & Singlefold Dispensers

PAPER PRODUCTS



A. TORK® HAND TOWEL CENTERFEED DISPENSER **SCA TISSUE**
 See-through smoke design reduces maintenance and allows quick and easy service checks. Elegant appearance complements any decor. High-impact flame retardant, chemical-resistant, rigid vinyl plastic provides low maintenance. The hinged door and adjustable port offers trouble free service. No touch, hands-free dispensing offers a sanitary benefit.
14100493 93T 12³/₄"H x 10¹/₈"W x 10"D, 7¹/₈" Roll dia., Smoke/Gray 1/ea.



B. CENTERPULL TOWEL DISPENSER **SOFIDEL AMERICA**
 Dispenses a variety of perforated one and two-ply roll towels and light-duty wipers in pre-measured single sheets through a patented self-adjusting dispensing device. No funnels or dispensing devices to adjust. Side-opening cover allows for simple loading.
57371000 91000 Black Base/Smoke Cover 1/ea.

C. SILHOUETTE® CENTERPULL TOWEL DISPENSER **WAUSAU PAPER/BAY WEST**
 Very user-friendly and requires only one hand to easily dispense soft, absorbent EcoSoft™ towels. Ideal for healthcare, food preparation and laboratory areas.
30030681 68100 9³/₄" x 13¹/₂" x 9¹/₂", Black Translucent 1/ea.

C-FOLD/MULTIFOLD TOWEL DISPENSERS



D. COMBO TOWEL CABINETS **CCP**
 Dispenser holds both multifold and C-fold towels. Heavy gauge steel with see-through towel gauge and hinged locking cabinet.
276015551 991C 15³/₈" x 11¹/₄" x 4¹/₁₆", Chrome 1/ea.
276015521 990W 15³/₈" x 11¹/₄" x 4¹/₁₆", White 1/ea.

E. OCEANS™ ULTRAFOLD TOUCHLESS FOLDED TOWEL DISPENSER **SAN JAMAR**
 Touchless Present® System presents smooth towels to the end user. Larger capacity with slimmer profile. Patented mouth dispenses C-fold and multifold towels. Designed to eliminate overloading of towels. Holds 450 C-fold or 750 multifold.
62571795 T1790WS 18"H x 11³/₄"W x 6¹/₄"D, White Sand 5/cs.



F. PRESENT® SYSTEM FOLDED TOWEL DISPENSER **SAN JAMAR**
 Multifold/C-fold towel dispenser. Low profile design makes this dispenser ideal for small places. The Present® System unfolds the towel for full sheet use and one-at-a-time towel presentation of C-fold or multifold towels. Adhesive backs for easy mounting. Break-resistant plastic.
62571750 T1750TBK 11¹/₂" x 11¹/₂" x 6", 1¹/₂ to 2 Sleeves, Black Pearl 1/ea.

G. TRUEFOLD™ C-FOLD/MULTIFOLD DISPENSER **SAN JAMAR**
 Flip door feature allows transformation to a true C-fold or multifold cabinet. Eliminates costly excess multi-towel dispensing. Metal front with unbreakable plastic back. Maximum towel size: 10¹/₄"W x 3³/₄"D. Holds 300 C-fold or 500 multifold.
62570041 T1905 14¹/₂"H x 11⁵/₈"W x 5"D, White 5/cs.

H. ULTRAFOLD PRESENT® FOLDED TOWEL DISPENSER **SAN JAMAR**
 The Ultrafold Present® System offers a touchless, smooth towel presentation that is 50% more capacity than a standard folded towel dispenser. Higher capacity reduces refill of towels. Capacity: 3 full sleeves. Break-resistant plastic. Holds 450 C-fold or 750 multifold.
62570700 T1700TBK 18"H x 11³/₄"W x 6¹/₄"D 1/ea.

SINGLEFOLD DISPENSERS



I. SINGLEFOLD TOWEL CABINETS **CCP**
 Features sturdy piano hinge and see through towel gauge for at-a-glance reference. Self-locking cabinet holds two packages of standard singlefold towels.
276063011 630C 7¹/₂" x 12¹³/₁₆" x 6¹/₂", Chrome 1/ea.
276006331 630W 7¹/₂" x 12¹³/₁₆" x 6¹/₂", White 1/ea.
27600633 630W 7¹/₂" x 12¹³/₁₆" x 6¹/₂", White 6/cs.

Feminine Hygiene/Dispensers/Receptacle Liners



FEMININE HYGIENE

A. TAMPONS

HOSPECO

Maxithins® Comfort Plus

Regular absorbency, open end flushable tampon with sewn-in cord. Paper overwrap, tampon and applicator all flushable and biodegradable.

14500100	MT100FS	100 ct.	100/cs.
14500010	MT500	100 ct.	500/cs.

Tampax®

Original regular Tampax® tampons individually wrapped in vending tube.

14501010	T500	500 ct.	500/cs.
----------	------	---------	---------



B. SANITARY NAPKINS

HOSPECO

Enviro Gards® Ultra Thin Maxi Pads

A super absorbent sanitary napkin that is both flushable and biodegradable.

14502004	EG4	#4 Box	125/cs.
----------	-----	--------	---------

Gards® Maxi Pads

Gards® #4 pads in vending box. For use in: Dual #1, Tri #74, FOC, FOCJR, ED-1, Dual #7, K-20H, K-40H, J1, 62 J6N, J6, 4-J, J10, J50, J31, J75.

14502147	4147	#4 Box	250/cs.
----------	------	--------	---------

Maxithins® 4n4 Channel

4n4 channel maxi pads in #4 box.

14500480	MT480	#4 Box	250/cs.
----------	-------	--------	---------

Maxithins® No. 4 Box

Maxi sanitary napkins in #4 box.

14500040	MT4	#4 Box	250/cs.
----------	-----	--------	---------

Maxithins® No. 8 Box

Maxi sanitary napkins in #8 box.

14500080	MT8	#8 Box	250/cs.
----------	-----	--------	---------

Maxithins® Ultra Thin Maxis w/Wings

Larger wings for a more secure fit. Ultra thin core for discreet protection. Dri-Gard cover sheet for superior dryness and comfort. No. 4 size vending box.

14500200	MT200	#4 Box	200/cs.
----------	-------	--------	---------



FEMININE HYGIENE DISPENSERS

C. FEMININE HYGIENE VENDING MACHINES

HOSPECO

Dispenses (15) boxes of Size No.4-147 or MT-4 sanitary napkins and 25 vended tampons.

14500014	D1	6 ³ / ₄ " x 26 ¹ / ₄ " x 10", White	1/ea.
14500088	D125	10" x 7 ¹ / ₄ " x 24", White, 25¢ Coin Release	1/ea.

Tampax®

Includes: tampon vending machine, No. 4 boxes, and 25 Maxithins® tampons.

14500311	MT1	6 ³ / ₄ " x 26 ¹ / ₄ " x 10"	1/ea.
----------	-----	--	-------



NAPKIN RECEPTACLE LINERS

D. SANITARY NAPKIN RECEPTACLE LINERS

CCP

Kraft paper liners. Fit #250 receptacle.

27601198	250K	11 ¹ / ₄ " x 7 ¹ / ₂ " x 3"	2/250/cs.
----------	------	---	-----------

E. PAPER LINERS

HOSPECO

Kraft waxed paper liners. With gusset-wax finish. Fit Sanisac and #250, #201W, #ND1W, #ND1E receptacles. 100% recycled post-consumer waste.

14502200	260	10 ¹ / ₄ " x 7 ¹ / ₂ " x 3 ¹ / ₂ "	900/cs.
----------	-----	--	---------

Health Gards®

Liners fit item #2201 receptacle and other swing-type receptacles.

14506802	6802W	8" x 7" x 8", Kraft	500/cs.
----------	-------	---------------------	---------

Health Gards® Waxed

Waxed paper liners for use in Hospital Specialty HS6140. Replaces RM liners or RCP 6141.

14500123	HS6141	9" x 10" x 3 ¹ / ₄ "	250/cs.
----------	--------	--	---------

Kraft wax paper liners, with gusset wax finish.

14500147	KL260	7 ¹ / ₂ " x 3 ¹ / ₂ " x 10 ¹ / ₄ ", Kraft	500/cs.
----------	-------	---	---------

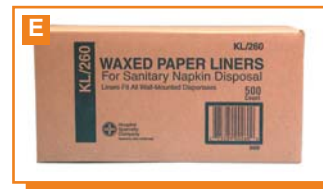

PAPER PRODUCTS

Napkin Liners & Receptacles/Toilet Seat Covers



PAPER PRODUCTS



A. SANITARY NAPKIN WAXED BAGS RUBBERMAID

Waxed bags for sanitary napkin receptacle. 50 bags/bundle; 250 per carton. Fits #6140 receptacle.
17708844 6141 9 3/4" x 3 3/4" x 9 7/8"H, Kraft 250/cs.

NAPKIN RECEPTACLES

B. HEALTH GARDS® SANITARY NAPKIN RECEPTACLE HOSPECO

Swing top, double entry, metal floor receptacle.
14502202 2201 9" x 9" x 10 3/4", White 1/ea.

C. HEALTH GARDS® SANITARY NAPKIN RECEPTACLES HOSPECO

Wall mount napkin receptacles.
145000131 ND1E 8" x 4" x 11", Stainless Steel 1/ea.
145000041 250201W 9" x 11" x 4", White, ABS Plastic 1/ea.

D. SANITARY NAPKIN RECEPTACLE RUBBERMAID

Space efficient and easy-to-service. Tight-fitting lid helps contain odor. Removable rigid liner is easy-to-clean. Five waxed paper bags included.
17708842 6140 12 1/2" x 5 1/4" x 10 3/4"H, White 1/ea.

TOILET SEAT COVERS

E. PRIME SOURCE® TOILET SEAT COVERS PRIME SOURCE®

Biodegradable covers are safe for all septic tanks. Will fit most seat cover dispensers.
750043705 75004370 250 ct., 1/2 Fold 250/cs.
75004372 75004372 250ct., 1/2 Fold 4/250/cs.
75004370 75004370 250 ct., 1/2 Fold 5000/cs.

F. SAFE-T-GARD® SEAT COVERS GEORGIA-PACIFIC

Quality paper seat covers for a protective barrier at an economical cost.
13707046 47046 1/2 Fold, 250 ct., White 5000/cs.

G. DISCREET SEAT™ TOILET SEAT COVERS HOSPECO

Very cost-effective, hygienic way to cover public seats.
14505000 DS5000 1/2 Fold, 250 ct. 5000/cs.

H. HEALTH GARDS® TOILET SEAT COVER REFILLS HOSPECO

For environmentally concerned customers. Made from 100% recycled paper. Disposable and flushable.
14505001 GREEN5000 1/2 Fold, 250 ct., Green 5000/cs.

I. HEALTH GARDS® TOILET SEAT COVER REFILLS HOSPECO

For environmentally concerned customers. Made from 100% recycled paper. Disposable and flushable.
14500291 HG1000 1/2 Fold, 1000 ct. 1000/cs.
14502025 HG2500 1/2 Fold, 2500 ct. 2500/cs.
14504650 HG5000 1/2 Fold, 5000 ct. 5000/cs.

J. SCOTT® PERSONAL SEATS KIMBERLY-CLARK

Flushable to help reduce litter and clogging. Meets EPA guidelines for post-consumer waste.
15400379 07410 125 ct., 15" x 18" 3000/cs.

Toilet Seat Covers & Dispensers/Child Care/Mats



A. TORK® UNIVERSAL TOILET SEAT COVERS SCA TISSUE

An easily dispensable, ready-for-use format. Hygienic, protects users from cross-contamination. 9½" L folded.

14100109 TC0020 1/2 Fold, 250 ct., 14½"W x 17"L, White, 1-Ply 20/250/cs.



TOILET SEAT COVER DISPENSERS

B. HEALTH GARDS® TOILET SEAT COVER DISPENSERS HOSPECO

Toilet seat cover dispenser holds two sleeves of 250 half-fold seat covers.

14500285 HG1S 1/2 Fold, (2) 250 ct., Smoke 1/ea.

14504315 HG12 1/2 Fold, (2) 250 ct., White 2/cs.



CHILD CARE

C. PRECIOUS® BABY CHANGING STATION HOSPECO

A necessity for every restroom. Folds up and lies flat against the wall when not in use. Includes two diaper compartments. Recommended installation meets ADA accessibility guidelines. Offers highest degree of safety with a horizontal wall-mount, keeping baby and adult close.

14506217 67016 1/ea.

D. PRECIOUS® BABY CHANGING TABLE LINERS HOSPECO

Disposable liners help guard against the transmission of infection.

14507017 67015 13" x 10¾", Liners 500/cs.

E. BABY CHANGING STATION RUBBERMAID

Horizontal baby changing stations meet all global safety standards (ASTM, ADA, FDA, EN). Features antimicrobial protection, easy reach hooks and built-in shelf and liner storage.

17701888 781888 33¼"L x 21½"W x 4"H, Light Platinum 1/ea.



F. STURDY STATION 2™ PROTECTIVE LINERS RUBBERMAID

Laminated two-ply tissue paper.

17707814 7817 17" x 12½", White, 320 ct. 320/cs.

G. PUDGIES® BY WET NAP® BABY WIPES SANI PROFESSIONAL

Gentle, hypoallergenic formula. Perfect for a baby's delicate skin. Designed for extra comfort and strength. Contains aloe and vitamin E. Alcohol and latex-free. Tissue-like dispensing allows for single-handed use.

49680630 A630FW 80 ct., 6¾" x 7¾", Unscented 960/cs.



BATH MATS

H. BATH MAT HOFFMASTER

A stock bath mat that is printed and embossed on highly absorbent wet strength paper stock.

18107600 25100 14½" x 20½", White, Plain 500/cs.

I. SAFTI-GRIP® BATH MATS RUBBERMAID

Perfect for shower stall or bathtub. Suction-backed to stay firmly in place.

17709101 703504 22½" x 14", Medium 4/cs.

17709105 704104 28" x 16", Large 4/cs.



Latex & Vinyl Gloves



LATEX GLOVES

A. PRIME SOURCE® EXAM GLOVES

PRIME SOURCE®

Latex exam gloves.

Lightly Powdered

75005110	75005110	X-Small, 5 MIL	1000/cs.
75005120	75005120	Small, 5 MIL	1000/cs.
75005130	75005130	Medium, 5 MIL	1000/cs.
75005140	75005140	Large, 5 MIL	1000/cs.
75005150	75005150	X-Large, 5 MIL	1000/cs.

Powder-Free

75005210	75005210	X-Small, 5 MIL	1000/cs.
75005220	75005220	Small, 5 MIL	1000/cs.
75005230	75005230	Medium, 5 MIL	1000/cs.
75005240	75005240	Large, 5 MIL	1000/cs.
75005250	75005250	X-Large, 5 MIL	1000/cs.



B. HI-VALU LATEX GLOVES

HI-VALU

High quality, single-use latex gloves. Fit either hand. Packaged in a dispenser box.

Powdered

73005160	73005160	Small, 3 MIL	1000/cs.
73005170	73005170	Medium, 3 MIL	1000/cs.
73005180	73005180	Large, 3 MIL	1000/cs.

Powder-Free

73005260	73005260	Small, 3 MIL	1000/cs.
73005270	73005270	Medium, 3 MIL	1000/cs.
73005280	73005280	Large, 3 MIL	1000/cs.
73005290	73005290	X-Large, 3 MIL	1000/cs.



C. EXAM GLOVES

PRIME SOURCE®

Latex exam gloves.

Powdered

75005317	75005317	X-Small, 5 MIL	1000/cs.
75005327	75005327	Small, 5 MIL	1000/cs.
75005337	75005337	Medium, 5 MIL	1000/cs.
75005347	75005347	Large, 5 MIL	1000/cs.
75005357	75005357	X-Large, 5 MIL	1000/cs.

Powder-Free

75005417	75005417	X-Small, Beige, 5 MIL	1000/cs.
75005427	75005427	Small, Beige, 5 MIL	1000/cs.
75005437	75005437	Medium, Beige, 5 MIL	1000/cs.
75005447	75005447	Large, Beige, 5 MIL	1000/cs.
75005457	75005457	X-Large, Beige, 5 MIL	1000/cs.



D. HANDSOFF® HOUSEHOLD HELPER®

LATEX DISPOSABLE GLOVES

PRIME SOURCE®

Cotton flock-lined latex gloves protect hands from household soaps and cleaners. Great for washing dishes, kitchen cleaning and handling household chemicals.

75005799	75005799	10 Per Bag, Yellow	100/cs.
75005800	75005800	Bulk, Yellow	100/cs.



VINYL GLOVES

E. HI-VALU STRETCH VINYL GLOVES

HI-VALU

Latex-free synthetic glove. Not for medical use. For single use only.

Lightly Powdered

73003160	73003160	Small	1000/cs.
73003170	73003170	Medium	1000/cs.
73003180	73003180	Large	1000/cs.
73003190	73003190	X-Large	1000/cs.

Powder-Free

73003260	73003260	Small	1000/cs.
73003270	73003270	Medium	1000/cs.
73003280	73003280	Large	1000/cs.
73003290	73003290	X-Large	1000/cs.



APPAREL

Vinyl Gloves



A. HANDSOFF® VINYL EXAM GLOVES PRIME SOURCE®

Provides better grip for instrument handling and greater comfort. Single-use gloves fit either hand and are packaged in a dispenser box.

Lightly Powdered

75006327	75006327	Small, Clear, 5 MIL	1000/cs.
75006337	75006337	Medium, Clear, 5 MIL	1000/cs.
75006347	75006347	Large, Clear, 5 MIL	1000/cs.
75006357	75006357	X-Large, Clear, 5 MIL	1000/cs.
75006655	75006655	2XL, Clear, 5 MIL	1000/cs.

Powder-Free

75006427	75006427	Small, Clear, 5 MIL	1000/cs.
75006431	75006431	Medium, Clear, 5 MIL	400/cs.
75006437	75006437	Medium, Clear, 5 MIL	1000/cs.
75006447	75006447	Large, Clear, 5 MIL	1000/cs.
75006457	75006457	X-Large, Clear, 5 MIL	1000/cs.

B. HANDSOFF® GENERAL PURPOSE GLOVES PRIME SOURCE®

General purpose, single-use vinyl gloves. 10"L with rolled cuff.

Lightly Powdered

75006160	75006160	Small, 3 MIL	1000/cs.
75006170	75006170	Medium, 3 MIL	1000/cs.
75006180	75006180	Large, 3 MIL	1000/cs.
75006190	75006190	X-Large, 3 MIL	1000/cs.

Powder-Free

75006260	75006260	Small, 3 MIL	1000/cs.
75006270	75006270	Medium, 3 MIL	1000/cs.
75006281	75006281	Large, 3 MIL	400/cs.
75006280	75006280	Large, 3 MIL	1000/cs.
75006290	75006290	X-Large, 3 MIL	1000/cs.

C. HANDSOFF® VINYL DISPOSABLE GLOVES PRIME SOURCE®

Powder-free vinyl gloves keep hands clean.

Office Helper®

75006299	75006299	10 Per Bag, Sensi-Pro	1000/cs.
75006300	75006300	Bulk, Sensi-Pro	100/cs.

Project Helper®

75006199	75006199	10 Per Bag, Clear	1000/cs.
75006200	75006200	Bulk, Clear	100/cs.

D. HANDSOFF® VINYL DISPOSABLE GLOVES PRIME SOURCE®

High quality single-use gloves. Increased sensitivity and stretch-to-fit without restriction of circulation.

Lightly Powdered

75006111	75006111	X-Small, 5 MIL	400/cs.
75006110	75006110	X-Small, 5 MIL	1000/cs.
75006121	75006121	Small, 5 MIL	400/cs.
75006120	75006120	Small, 5 MIL	1000/cs.
750066205	75006620	Small, Blue, 5 MIL	100/cs.
75006621	75006621	Small, Blue, 5 MIL	400/cs.
75006620	75006620	Small, Blue, 5 MIL	1000/cs.
75006131	75006131	Medium, 5 MIL	400/cs.
75006130	75006130	Medium, 5 MIL	1000/cs.
75006631	75006631	Medium, Blue, 5 MIL	400/cs.
75006630	75006630	Medium, Blue, 5 MIL	1000/cs.
75006141	75006141	Large, 5 MIL	400/cs.
75006140	75006140	Large, 5 MIL	1000/cs.
75006641	75006641	Large, Blue, 5 MIL	400/cs.
75006640	75006640	Large, Blue, 5 MIL	1000/cs.
75006151	75006151	X-Large, 5 MIL	400/cs.
75006150	75006150	X-Large, 5 MIL	1000/cs.
75006651	75006651	X-Large, Blue, 5 MIL	400/cs.
75006650	75006650	X-Large, Blue, 5 MIL	1000/cs.
75006155	75006155	2XL, 5 MIL	1000/cs.

Vinyl & Poly Gloves



A. HANDSOFF® VINYL DISPOSABLE GLOVES (CONT.) PRIME SOURCE®

Powder-Free			
75006210	75006210	X-Small, 5 MIL	1000/cs.
750062205	75006220	Small, 5 MIL	100/cs.
75006220	75006220	Small, 5 MIL	1000/cs.
75006720	75006720	Small, Blue, 5 MIL	1000/cs.
750062305	75006230	Medium, 5 MIL	100/bx.
75006231	75006231	Medium, 5 MIL	400/cs.
75006230	75006230	Medium, 5 MIL	1000/cs.
75006730	75006730	Medium, Blue, 5 MIL	1000/cs.
750062405	75006240	Large, 5 MIL	100/cs.
75006241	75006241	Large, 5 MIL	400/cs.
75006240	75006240	Large, 5 MIL	1000/cs.
75006740	75006740	Large, Blue, 5 MIL	1000/cs.
750062505	75006250	X-Large, 5 MIL	100/cs.
75006251	75006251	X-Large, 5 MIL	400/cs.
75006250	75006250	X-Large, 5 MIL	1000/cs.
75006750	75006750	X-Large, Blue, 5 MIL	1000/cs.
75006255	75006255	2XL, 5 MIL	1000/cs.



B. CONTACT™ VINYL GLOVES FOOD HANDLER

Textured vinyl gloves. Unique pebble texture yields exceptional grip and slip-resistance, perfect in applications where maximum control is needed. Textured for maximum fingertip sensitivity. Form fitting and durable. Handy dispenser box.

39453925	102FHCN14	Medium, Powder-Free	400/cs.
----------	-----------	---------------------	---------



C. VINYL DISPOSABLE GLOVES THE SAFETY ZONE

Powder-free, rolled cuff. Made with USDA approved materials (for safe food handling). Ambidextrous. Seamless.

71952102	GVP9LG	Large, 9", Clear, 5 MIL	10/100/cs.
----------	--------	-------------------------	------------

POLY GLOVES

D. HI-VALU POLYETHYLENE GLOVES HI-VALU

Economical, single-use poly gloves with a lightly embossed surface. Easy to slip on and off. Fit either hand. Packaged in a dispenser box.

73007122	73007122	Small, 500 ct.	2000/cs.
73007132	73007132	Medium, 500 ct.	2000/cs.
73007142	73007142	Large, 500 ct.	2000/cs.
73007152	73007152	X-Large, 500 ct.	2000/cs.



E. HANDSOFF® POLYETHYLENE GLOVES PRIME SOURCE®

Powder-free gloves keep hands clean.

Party Helper®			
75007199	75007199	25 Per Bag	2500/cs.
75007200	75007200	Bulk	100/cs.

Pet Helper®			
75008999	75008999	10 Per Bag, Sensi-Pro	1000/cs.
75009000	75009000	Bulk, Sensi-Pro	100/cs.

Pre-Loaded Combo Strip Clip

75006301	75006301	Pre-Loaded Clip Strips for Display	10/cs.
----------	----------	------------------------------------	--------

Retail Display Unit

75005798	75005798	For Bagged Products	1/ea.
----------	----------	---------------------	-------



Poly Gloves



A. HANDSOFF® POLYETHYLENE DISPOSABLE GLOVES PRIME SOURCE®

Economical, single-use poly gloves with a lightly embossed surface. Easy to slip on and off. Fit either hand. Packaged in a dispenser box.

75007110	75007110	X-Small, Clear, Economy	10000/cs.
75007125	75007125	Small, Clear	10000/cs.
75007120	75007120	Small, Clear, Economy, 100 Gloves/Pack	10000/cs.
750071205	75007120	Small, Clear, Economy, 100 Gloves/Pack	10/100/cs.
75007126	75007126	Small, Clear, Premium, 1 MIL, 100 Gloves/Pack	1000/cs.
75007122	75007122	Small, Clear, 500 Gloves/Pack	2000/cs.
75007123	75007123	Small, Clear, 500 Gloves/Pack	10000/cs.
75007135	75007135	Medium, Clear	10000/cs.
750071305	75007130	Medium, Clear, 100 Gloves/Pack	1000/cs.
75007130	75007130	Medium, Clear, 100 Gloves/Pack	10000/cs.
750071395	75007139	Medium, Clear, Economy, 100 Gloves/Pack	1000/cs.
75007139	75007139	Medium, Clear, Economy, 100 Gloves/Pack	10000/cs.
75007136	75007136	Medium, Clear, Premium, 1 MIL, 100 Gloves/Pack	1000/cs.
75007132	75007132	Medium, Clear, 500 Gloves/Pack	2000/cs.
75007133	75007133	Medium, Clear, 500 Gloves/Pack	10000/cs.
75007145	75007145	Large, Clear	10000/cs.
750071495	75007149	Large, Clear, 100 Gloves/Pack	1000/cs.
75007149	75007149	Large, Clear, 100 Gloves/Pack	10000/cs.
750071405	75007140	Large, Clear, Economy, 100 Gloves/Pack	1000/cs.
75007140	75007140	Large, Clear, Economy, 100 Gloves/Pack	10000/cs.
75007147	75007147	Large, Clear, 100 Gloves/Header	10000/cs.
75007146	75007146	Large, Clear, Premium, 1 MIL, 100 Gloves/Pack	1000/cs.
75007142	75007142	Large, Clear, 500 Gloves/Pack	2000/cs.
75007157	75007157	X-Large, Clear, 100 Gloves/Header	10000/cs.
750071595	75007159	X-Large, Clear, 100 Gloves/Pack	1000/cs.
75007159	75007159	X-Large, Clear, 100 Gloves/Pack	10000/cs.
750071505	75007150	X-Large, Clear, Economy, 100 Gloves/Pack	10/100/cs.
75007156	75007156	X-Large, Clear, Premium, 1 MIL, 100 Gloves/Pack	1000/cs.
75007152	75007152	X-Large, Clear, 500 Gloves/Pack	2000/cs.
75007153	75007153	X-Large, Clear, 500 Gloves/Pack	10000/cs.



B. FOODHANDLER® POLY GLOVES FOOD HANDLER

High quality poly gloves with a lightly embossed surface for better grip.

39454502	104502	Small	20/500/cs.
39454505	104502CP	Small, Space-Saving Convenience Pack	2000/cs.
39454504	104504	Medium	20/500/cs.
39451045	104504CP	Medium, Space-Saving Convenience Pack	2000/cs.



C. TEXTRA™ POLY GLOVES FOOD HANDLER

Textured cast poly gloves. More comfortable than traditional poly gloves, yet easy to slip on and off. Unique, deep-textured design provides improved grip and control while retaining softness and comfort. Enhanced textured surface for better gripping.

39450029	104FHCT14	Medium, Dispenser Box	10/100/cs.
39450130	104FHCT16	Large, Dispenser Box	10/100/cs.

Nitrile & Synthetic Gloves



NITRILE GLOVES

A. HANDSOFF® NITRILE DISPOSABLE GLOVES PRIME SOURCE®

High quality, single-use gloves. Protection against animal fats, oil-based solvents, petroleum, caustics and acids. Three times the strength and puncture-resistance of conventional disposable gloves. 9½" length with rolled cuff. Fit either hand. Packaged in a dispenser box.

Lightly Powdered

75008310	75008310	X-Small, Blue, 5 MIL	1000/cs.
75008320	75008320	Small, Blue, 5 MIL	1000/cs.
75008330	75008330	Medium, Blue, 5 MIL	1000/cs.
75008340	75008340	Large, Blue, 5 MIL	1000/cs.
75008350	75008350	X-Large, Blue, 5 MIL	1000/cs.

Powder-Free

75008410	75008410	X-Small, Blue, 5 MIL	1000/cs.
75008420	75008420	Small, Blue, 5 MIL	1000/cs.
75008430	75008430	Medium, Blue, 5 MIL	1000/cs.
75008440	75008440	Large, Blue, 5 MIL	1000/cs.
75008450	75008450	X-Large, Blue, 5 MIL	1000/cs.



B. MEDHANDLER® NITRILE EXAM GLOVES FOOD HANDLER

Powder-free. Latex and protein-free; eliminates the risk of immediate or delayed allergic reaction. Provides a high degree of puncture and chemical resistance. Relaxed fit that follows the hand's natural contours, providing greater comfort. Fingertip Bisque finish provides excellent wet and dry grip. ISO 9002 manufactured. FDA compliant.

39450091	103114	Medium, Light Blue	10/100/cs.
39450092	103116	Large, Light Blue	1000/cs.
39450093	103118	X-Large, Light Blue	1000/cs.



SYNTHETIC GLOVES

C. HANDSOFF® MICRO CLEAN™ DISPOSABLE GLOVES PRIME SOURCE®

High quality, powder-free single-use gloves. Synthetic material with anti-microbial additives. Non-latex and non-allergenic. Fit either hand. Packaged in a dispenser box.

75008731	75008731	Medium, White, 5 MIL	400/cs.
75008741	75008741	Large, White, 5 MIL	400/cs.

D. HANDSOFF® SENSI-PRO DISPOSABLE GLOVES PRIME SOURCE®

High quality, single-use gloves. Protection against animal fats, oil-based solvents, petroleum, caustics and acids. Three times the strength and puncture-resistance of conventional disposable gloves. 9½" length with rolled cuff. Fit either hand. Packaged in a dispenser box.

Lightly Powdered

75008825	75008825	Small, Beige, 5 MIL	400/cs.
75008826	75008826	Small, Beige, 5 MIL	1000/cs.
75008824	75008824	Small, Blue, 5 MIL	400/cs.
75008820	75008820	Small, White, 5 MIL	400/cs.
75008821	75008821	Small, White, 5 MIL	1000/cs.
75008835	75008835	Medium, Beige, 5 MIL	400/cs.
75008836	75008836	Medium, Beige, 5 MIL	1000/cs.
75008834	75008834	Medium, Blue, 5 MIL	400/cs.
75008830	75008830	Medium, White, 5 MIL	400/cs.
75008831	75008831	Medium, White, 5 MIL	1000/cs.
75008845	75008845	Large, Beige, 5 MIL	400/cs.
75008846	75008846	Large, Beige, 5 MIL	1000/cs.
75008844	75008844	Large, Blue, 5 MIL	400/cs.
75008840	75008840	Large, White, 5 MIL	400/cs.
75008841	75008841	Large, White, 5 MIL	1000/cs.
75008855	75008855	X-Large, Beige, 5 MIL	400/cs.
75008856	75008856	X-Large, Beige, 5 MIL	1000/cs.
75008854	75008854	X-Large, Blue, 5 MIL	400/cs.
75008850	75008850	X-Large, White, 5 MIL	400/cs.
75008851	75008851	X-Large, White, 5 MIL	1000/cs.



Synthetic Gloves/Disposable Hats/Hairnets



APPAREL



A. HANDSOFF® SENSI-PRO DISPOSABLE GLOVES (CONT.) PRIME SOURCE®

Powder-Free			
75008925	75008925	Small, Beige, 5 MIL	400/cs.
75008926	75008926	Small, Beige, 5 MIL	1000/cs.
75008924	75008924	Small, Blue, 5 MIL	400/cs.
75008920	75008920	Small, White, 5 MIL	400/cs.
75008921	75008921	Small, White, 5 MIL	1000/cs.
75008935	75008935	Medium, Beige, 5 MIL	400/cs.
75008936	75008936	Medium, Beige, 5 MIL	1000/cs.
75008934	75008934	Medium, Blue, 5 MIL	400/cs.
750089305	75008930	Medium, White, 5 MIL	100/cs.
75008930	75008930	Medium, White, 5 MIL	400/cs.
75008931	75008931	Medium, White, 5 MIL	1000/cs.
75008945	75008945	Large, Beige, 5 MIL	400/cs.
75008946	75008946	Large, Beige, 5 MIL	1000/cs.
75008944	75008944	Large, Blue, 5 MIL	400/cs.
750089405	75008940	Large, White, 5 MIL	100/cs.
75008940	75008940	Large, White, 5 MIL	400/cs.
75008941	75008941	Large, White, 5 MIL	1000/cs.
75008955	75008955	X-Large, Beige, 5 MIL	400/cs.
75008956	75008956	X-Large, Beige, 5 MIL	1000/cs.
75008954	75008954	X-Large, Blue, 5 MIL	400/cs.
75008950	75008950	X-Large, White, 5 MIL	400/cs.
75008951	75008951	X-Large, White, 5 MIL	1000/cs.

B. INTE-FIT® HYBRID GLOVES INTEPLAST CORPORATION

FDA Compliance for food contact and food handling. Latex-free and vinyl-free and powder-free to minimize allergic reactions. Compact boxes uses less storage space. Textured for comfort and stretch. Free of DOP/DEHP substances. Non-sterile, ambidextrous fit. Great alternative to vinyl gloves. Environmentally friendly item.

03600120	HYBF001	Small	1000/cs.
03600121	HYBF002	Medium	1000/cs.
03600122	HYBF003	Large	1000/cs.
03600123	HYBF004	X-Large	1000/cs.

DISPOSABLE HATS/HAIRNETS

C. PRIME SOURCE® BOUFFANT CAPS PRIME SOURCE®

Latex-free polypropylene cap. Comfortable and cool to wear.

75009242	75009242	18", Blue, 14 g	1000/cs.
75009232	75009232	18", Green, 14 g	1000/cs.
75009222	75009222	18", White, 14 g	1000/cs.
75009252	75009252	18", White, Pleated, 14 g	1000/cs.
75009244	75009244	21", Blue, 14 g	1000/cs.
75009234	75009234	21", Green, 14 g	1000/cs.
750092245	75009224	21", White, 14 g	100/cs.
75009224	75009224	21", White, 14 g	1000/cs.
75009254	75009254	21", White, Pleated, 14 g	1000/cs.
75009246	75009246	24", Blue, 14 g	1000/cs.
75009236	75009236	24", Green, 14 g	1000/cs.
75009226	75009226	24", White, 14 g	1000/cs.
75009256	75009256	24", White, Pleated, 14 g	1000/cs.
75009228	75009228	28", White, 14 g	1000/cs.

D. PRIME SOURCE® HAIRNETS PRIME SOURCE®

Easy to wear elastic fit. Regular size 1/8" honeycomb weave.

75009202	75009202	18", White, 100 ct.	1000/cs.
75009214	75009214	21", Brown, 100 ct.	1000/cs.
75009204	75009204	21", White, 100 ct.	1000/cs.
75009206	75009206	24", White, 100 ct.	1000/cs.

Disposable Hats/Hairnets, Mask & Aprons



A. PRIME SOURCE® POLY HOOD PRIME SOURCE®

A bouffant and beard guard all in one!
75009346 75009346 17", White 1000/cs.



B. PRIME SOURCE® BEARD GUARDS PRIME SOURCE®

Full size and easy to wear. Elastic band keeps guard securely in place. Cloth-like, non-woven, lint-free fabric and breathable fine mesh nylon.
75009267 75009267 18", Blue, Nylon Mesh, 100 ct. 1000/cs.
75009266 75009266 18", White, Nylon Mesh, 100 ct. 1000/cs.
75009262 75009262 18", White, Polypropylene, 100 ct. 1000/cs.
750092625 75009262 18", White, Polypropylene, 100 ct. 100/cs.
75009264 75009264 21", White, Polypropylene, 100 ct. 500/cs.



C. HN500 HAIRNET CELLUCAP MFG CO

Lightweight nylon hairnets made from a single strand, 15 denier nylon with 1/4" aperture. Blends seamlessly with similar colored hair for a discreet look. Individually tissueed to avoid tangling.
246645005 HN5DB 26", Dark Brown 144/cs.



D. LE CLASSIC™ CHEF HAT CELLUCAP MFG CO

Traditional style chef hat. Signature AirVent Star system in crown ensures cool comfort. Touch 'n Seal Sizer® guarantees the right fit. Packed fully formed and can be imprinted.
24662015 CC2007 7", White 12/cs.



E. ROUND CROWN® PAPER CAP CELLUCAP MFG CO

Distinctive low-profile disposable paper cap is perfect for food handling, industrial and institutional environments. White kraft paper band with white tissue low-profile crown. Available in stock stripes or custom printing.
24660029 RC100W White 10/100/cs.



DISPOSABLE MASK

F. PRIME SOURCE® DUST MASK PRIME SOURCE®

Fiber-free and fluid resistant three-ply mask has pleated ear-loop design. Pleats add fullness for proper coverage. 99% bacterial efficiency.
75009341 75009341 One Size 600/cs.



DISPOSABLE APRONS

G. PRIME SOURCE® APRON GOWNS PRIME SOURCE®

Gowns with elastic wrists. Individually wrapped.
75007279 75007279 X-Large, Blue, Embossed 100/cs.
75007280 75007280 X-Large, Blue 100/cs.
75007281 75007281 X-Large, White 100/cs.



APPAREL

Disposable Aprons



APPAREL

A. PRIME SOURCE® POLYETHYLENE APRONS PRIME SOURCE®

Economical light-duty alternative.

75001106	<i>75001106</i>	28"W x 46"L, White	100/cs.
75007245	<i>75007245</i>	32"W x 52"L, White, 1.40 MIL	500/cs.

Embossed Finish

75000089	<i>75000089</i>	28"W x 46"L, Blue, Bulk Pack, 1.50 MIL	500/cs.
75007239	<i>75007239</i>	28"W x 46"L, Clear, Bulk Pack, 1 MIL	1000/cs.
75007240	<i>75007240</i>	28"W x 46"L, Clear, Individual Pack, 1 MIL	1000/cs.
75007241	<i>75007241</i>	28"W x 46"L, Clear, Roll, 1 MIL	1000/cs.
75007274	<i>75007274</i>	28"W x 46"L, Clear, Bulk Pack, 2 MIL	500/cs.
75007246	<i>75007246</i>	28"W x 46"L, White, Bulk Pack, 1 MIL	1000/cs.
75007247	<i>75007247</i>	28"W x 46"L, White, Individual Pack, 1 MIL	1000/cs.
75007267	<i>75007267</i>	28"W x 46"L, White, Bulk Pack, 1.50 MIL	500/cs.
750072665	<i>75007266</i>	28"W x 46"L, White, Individual Pack, 1.50 MIL	100/cs.
75007266	<i>75007266</i>	28"W x 46"L, White, Individual Pack, 1.50 MIL	500/cs.
750072725	<i>75007272</i>	28"W x 46"L, White, Bulk Pack, 2 MIL	100/cs.
75007272	<i>75007272</i>	28"W x 46"L, White, Bulk Pack, 2 MIL	500/cs.
75007253	<i>75007253</i>	28"W x 56"L, White, Bulk Pack, 1 MIL	500/cs.
75007259	<i>75007259</i>	35"W x 60"L, White, Bulk Pack, 1.50 MIL	500/cs.

Smooth Finish

75007249	<i>75007249</i>	24"W x 42"L, White, Bulk Pack, 1 MIL	1000/cs.
750072505	<i>75007250</i>	24"W x 42"L, White, Individual Pack, 1 MIL	100/cs.
75007250	<i>75007250</i>	24"W x 42"L, White, Individual Pack, 1 MIL	1000/cs.
75007270	<i>75007270</i>	28"W x 46"L, Blue, Bulk Pack, 1 MIL	500/cs.
75007242	<i>75007242</i>	28"W x 46"L, Blue, Bulk Pack, 1 MIL	1000/cs.
75007271	<i>75007271</i>	28"W x 46"L, Red, Bulk Pack, 1.50 MIL	500/cs.
75007243	<i>75007243</i>	28"W x 46"L, White, Bulk Pack, 1 MIL	1000/cs.
75007244	<i>75007244</i>	28"W x 46"L, White, Individual Pack, 1 MIL	1000/cs.
75007269	<i>75007269</i>	28"W x 46"L, White, Bulk Pack, 1.50 MIL	500/cs.
75007268	<i>75007268</i>	28"W x 46"L, White, Individual Pack, 1.50 MIL	500/cs.
75007273	<i>75007273</i>	28"W x 46"L, White, Bulk Pack, 2 MIL	500/cs.
75007275	<i>75007275</i>	28"W x 55"L, Blue, Bulk Pack, 1.50 MIL	500/cs.
75007248	<i>75007248</i>	28"W x 55"L, White, Bulk Pack, 1.50 MIL	500/cs.

B. PRIME SOURCE® VINYL APRONS PRIME SOURCE®

Extra protection from grease, oil and fat. Made of quality vinyl with nylon-serged edges and heat-sealed grommets.

75007037	<i>75007037</i>	28" x 46", Blue, 1 MIL	1000/cs.
75007284	<i>75007284</i>	30" x 36", White, Raw Edge, 8 MIL	72/cs.
75007001	<i>75007001</i>	35" x 45", Blue, Raw Edge, 6 MIL	72/cs.
75007006	<i>75007006</i>	35" x 45", Blue, Sewn Edge, 6 MIL	72/cs.
750070265	<i>75007026</i>	35" x 45", Blue, Sewn Edge, 8 MIL	12/cs.
75007026	<i>75007026</i>	35" x 45", Blue, Sewn Edge, 8 MIL	72/cs.
750070285	<i>75007028</i>	35" x 45", White, Raw Edge, 8 MIL	12/pk.
75007002	<i>75007002</i>	35" x 48", Blue, Raw Edge, 6 MIL	72/cs.
75007007	<i>75007007</i>	35" x 48", Blue, Sewn Edge, 6 MIL	72/cs.
75007027	<i>75007027</i>	35" x 48", Blue, Sewn Edge, 8 MIL	72/cs.
75007035	<i>75007035</i>	35" x 48", White, Sewn Edge, 6 MIL	72/cs.
75007003	<i>75007003</i>	35" x 50", Blue, Raw Edge, 6 MIL	72/cs.
75007008	<i>75007008</i>	35" x 50", Blue, Sewn Edge, 6 MIL	72/cs.
75007036	<i>75007036</i>	35" x 52", White, Die Cut, 8 MIL	72/cs.
75007004	<i>75007004</i>	35" x 55", Blue, Raw Edge, 6 MIL	72/cs.
75007009	<i>75007009</i>	35" x 55", Blue, Sewn Edge, 6 MIL	72/cs.
75007029	<i>75007029</i>	35" x 55", Blue, Sewn Edge, 8 MIL	72/cs.

C. FOODHANDLER® CLASSIC POLY APRON FOOD HANDLER

High quality, tear resistant, with extra long ties for ease and comfort. Convenient one-at-a-time dispensing.

394525225	<i>250FH20</i>	28" x 46", White, Embossed, 1 MIL	100/cs.
------------------	----------------	-----------------------------------	---------

Disposable Smocks/Oven Mitt/Safety Gloves



DISPOSABLE SMOCKS

A. PRIME SOURCE® DISPOSABLE SMOCKS PRIME SOURCE®

Will not absorb moisture. Extremely durable and tear resistant. Reinforced neck band. Full-length elastic cuffed sleeves. Polyethylene coated. Standard length.

75009270	75009270	Small, White	100/cs.
75009271	75009271	Medium, White	100/cs.
75009272	75009272	Large, White	100/cs.
75009273	75009273	X-Large, White	100/cs.
75009278	75009278	X-Large, White, Short Sleeve	100/cs.
75009274	75009274	2XL, White	100/cs.
75009279	75009279	2XL, White, Short Sleeve	100/cs.
75009275	75009275	3XL, White	100/cs.
75009276	75009276	4XL, White	100/cs.
75009277	75009277	5XL, White	100/cs.



B. PRIME SOURCE® DISPOSABLE SMOCKS PRIME SOURCE®

Extra long smocks will not absorb moisture. Extremely durable and tear resistant. Reinforced neck band. Full-length elastic cuffed sleeves.

75009280	75009280	Small, White	100/cs.
75009281	75009281	Medium, White	100/cs.
75009282	75009282	Large, White	100/cs.
75009283	75009283	X Large, White	100/cs.
75009284	75009284	2X Large, White	100/cs.
75009285	75009285	3X Large, White	100/cs.



OVEN MITT

C. PRIME SOURCE® OVEN MITT PRIME SOURCE®

Silicone treated oven mitt.

750000451	75000045	16"	1/pr.
75000045	75000045	16"	72/pr.



SAFETY GLOVES

D. PRIME SOURCE® KNIT WORK GLOVES PRIME SOURCE®

Grip dots on both sides.

750075095	75007509		12/cs.
75007509	75007509		240/cs.



E. PRIME SOURCE® STRING KNIT GLOVES PRIME SOURCE®

Poly/cotton blend knitted gloves. Seven threads per inch. Bleached and unbleached with sewn wrist bands. Fits either hand.

75007507	75007507	Lightweight, White Wrist	480/cs.
750075015	75007501	Economy, Blue Wrist	12/cs.
75007501	75007501	Economy, Blue Wrist	480/cs.
750075035	75007503	Mediumweight, Green Wrist	12/cs.
75007503	75007503	Mediumweight, Green Wrist	480/cs.
75007505	75007505	Heavyweight, Gold Wrist	288/cs.



Safety Gloves/Protective Sleeves/Knee Pads



A. HANDSOFF® REUSABLE FLOCK-LINED LATEX GLOVES PRIME SOURCE®

Embossed 13" gauntlet with straight cuff. Soft cotton flock lining absorbs perspiration and comforts the hand. Not for medical use.

75005710	75005710	X-Small, Yellow, General Purpose	144/cs.
75005822	75005822	Small, Blue, 20 MIL	144/cs.
75005722	75005722	Small, Yellow, 20 MIL	144/cs.
750057205	75005720	Small, Yellow, General Purpose	12/cs.
75005720	75005720	Small, Yellow, General Purpose	144/cs.
75005832	75005832	Medium, Blue, 20 MIL	144/cs.
75005732	75005732	Medium, Yellow, 20 MIL	144/cs.
750057305	75005730	Medium, Yellow, General Purpose	12/cs.
75005730	75005730	Medium, Yellow, General Purpose	144/cs.
75005842	75005842	Large, Blue, 20 MIL	144/cs.
75005742	75005742	Large, Yellow, 20 MIL	144/cs.
750057405	75005740	Large, Yellow, General Purpose	12/cs.
75005740	75005740	Large, Yellow, General Purpose	144/cs.
75005852	75005852	X-Large, Blue, 20 MIL	144/cs.
75005752	75005752	X-Large, Yellow, 20 MIL	144/cs.
750057505	75005750	X-Large, Yellow, General Purpose	12/cs.
75005750	75005750	X-Large, Yellow, General Purpose	144/cs.



B. JOBSELECT® SCOURING GLOVES FOOD HANDLER

100% nitrile compound affords maximum resistance to snags, punctures, abrasions and cuts. Longer unlined pot sink gloves. Latex-free.

394563521	121403	18", Large, Green, 22 MIL	1/pr.
-----------	--------	---------------------------	-------



C. HEAVY-DUTY CLEANING/MAINTENANCE GLOVES RUBBERMAID

Designed for harsh applications and rough materials. Breathable stretch materials add to comfort. Knuckles padded with perforated Neoprene. Hook and loop fastener does not snag or collect debris. One hand strap adjustment.

17700045	9H00	Large, Red/Black	6/cs.
17700043	9H01	X-Large, Red/Black	6/cs.



PROTECTIVE SLEEVES

D. PRIME SOURCE® PROTECTIVE SLEEVES PRIME SOURCE®

Heat-sealed with enclosed elastic at the wrist and shoulder.

75007071	75007071	18", Blue, 12 boxes per case, 6 MIL, Vinyl	144/cs.
75007081	75007081	18", Blue, 12 boxes per case, 8 MIL, Vinyl	144/cs.
75007064	75007064	18", Clear, 12 boxes per case, 4 MIL, Vinyl	144/cs.
75007084	75007084	18", Clear, 12 boxes per case, 8 MIL, Vinyl	144/cs.
75007082	75007082	18", White, 12 boxes per case, 8 MIL, Vinyl	144/cs.



E. PRIME SOURCE® PROTECTIVE SLEEVES PRIME SOURCE®

Low cost waterproof protection for light-duty, limited-use applications. Heat-sealed with enclosed elastic at each end.

75007231	75007231	16", Blue	2000/cs.
75007221	75007221	16", White	2000/cs.
75007224	75007224	18", Blue	2000/cs.
75007223	75007223	18", White	2000/cs.



KNEE PADS

F. I-GEL KNEE PADS RUBBERMAID

Non-marring cap protects surfaces. Non-skid cap helps to avoid slipping. I-Gel insert absorbs impact. Breathable perforated Neoprene material. Notched for comfort when standing. One-strap sizing plus opening for ventilation. Adjustable sizing pads on both sides.

17700047	9H10	4 1/4"H x 9"L x 7"W, Red	6/cs.
----------	------	--------------------------	-------

G. SWIVEL-FLEX KNEE PADS RUBBERMAID

Maneuverability with compact swivel cap. Flexible materials provide better fit and lasting comfort. Front strapping system fastens easily.

17700042	9H11	4 1/2"H x 10 1/2"L x 7 1/2"W, Red	6/cs.
----------	------	-----------------------------------	-------



Wipers



WIPERS

A. CHIX® FOODSERVICE TOWELS CHICOPEE

Foodservice Towels

The preferred reusable foodservice towels which are washable, rinsable and absorbent for general wiping tasks.

25600006	8253	13 ¹ / ₂ " x 21", Blue w/Blue Logo	150/cs.
25600167	8252	13 ¹ / ₂ " x 21", White w/Red Logo	150/cs.
25600165	8250	13 ¹ / ₂ " x 24", White w/Red Logo	150/cs.

Pro-Quat™ Foodservice Towels

Sanitizer specific foodservice towels work with, not against, sanitizers. Extends the life of the sanitizing solution. Effectively releases sanitizer onto surface. Provides extra protection against cross-contamination. Solutions used with Chix® Professional Series towels remain consistently above 200 ppm for well over four hours when managed properly.

25600066	0077	13" x 21", Red/Red, Medium/Heavy-Duty	150/cs.
-----------------	------	---------------------------------------	---------



B. CHIX® WORXWELL® WORK TOWELS CHICOPEE

Worxwell® towels are engineered specifically as shop towel and rag replacements for use in heavy-duty applications. Each towel is designed with characteristics specific to extended use, such as durability, absorbency, solvent compatibility, low linting and consistent performance.

25600250	8483	13" x 15", White	300/cs.
-----------------	------	------------------	---------



C. CHIX® WIPERS CHICOPEE

Competitive Wet Wipers

Non-woven, rayon-based. Can be used for one to two days. Wipes water-based liquids and debris. Rinsable and reusable. Packed in dispenser case.

25608507	8507	13 ¹ / ₂ " x 24", Pink Diamond	200/cs.
25601009	8506	13 ¹ / ₂ " x 24", Pink Diamond	900/cs.

Wet Wipe

A lightweight wet wiping towel. Picks up spills and food particles efficiently. Rinses easily to maintain a pleasant appearance.

25600141	8311	14" x 21", Pink Stripe, Dispenser Box	200/cs.
-----------------	------	---------------------------------------	---------



D. QUIX® FOODSERVICE TOWELS CHICOPEE

Dry, pretreated, water activated cleaning and sanitizing towels. Simple one-step preparation. Helps eliminate mixing and mishaps. Prompts foodservice workers to clean better and more often. Meets federal sanitizing guidelines. Emits pleasant, fresh fragrance. Economical, safe and easy to store.

25608294	8294	20 ¹ / ₂ " x 12 ³ / ₄ ", Pink	72/cs.
-----------------	------	---	--------



E. BRAWNY INDUSTRIAL™ LIGHT-DUTY PAPER WIPERS GEORGIA-PACIFIC

Multi-purpose, single use, two-ply white paper wipers perfect for glass cleaning, small spills, light lubes and light solvent use. Convenient, portable pop-up box.

13709221	29221	148 ct., 8" x 12 ¹ / ₂ "	2960/cs.
-----------------	-------	--	----------



F. INTERSTATE® SINGLEFOLD AUTO CARE PAPER WIPERS GEORGIA-PACIFIC

Premium, two-ply blue windshield and auto care disposable paper towels. Provides streak-free cleaning ideal for automotive windshields, mirrors and more. Blue color stays cleaner looking and provides for extended use to help reduce costs. Popular, space-saving, moisture-resistant poly case helps protect the product.

13700702	00350	188 ct., 9 ¹ / ₂ " x 10 ¹ / ₄ ", Blue	2250/cs.
-----------------	-------	---	----------



Wipers



A. SOFT-N-FRESH® WIPERS GEORGIA-PACIFIC

Made from airlaid bonded cellulose to deliver exceptional capacity for tackling spills or for patient care as a disposable washcloth. This cost-effective wiper even stands up in light solvents to make cleaning a breeze. Popular uses include patient care (wash cloths), healthcare and light manufacturing cleaning tasks. These economical medium-duty wipers feature a 1/4-fold design that provides fast dispensing for one or more wipers at a time and come in protective poly packaging.

13709505 29505 55 ct., 12 1/2" x 13", White 990/cs.

B. SANIWORKS™ FOODSERVICE TOWELS HOSPECO

Reduce the cost of terry towels and linen rental towels by at least 40%. This all purpose line of towels is functional for a wide range of applications including wiping tables and counters or washing pots and pans. Color-coded to avoid cross contamination. Highly absorbent with exceptional strength. Convenient, protective packaging for inventory control.

14508796 MN8796 150 ct., 13" x 21", Blue, Antimicrobial 150/cs.

C. KIMTECH SCIENCE® KIMWIPES® DELICATE TASK WIPERS KIMBERLY-CLARK

Light-duty wipers that can handle a variety of delicate tasks. Easily wipes up liquid and dust. Anti-static dispensing reduces lint and electrostatic discharge, controls usage and portability, reduces waste.

15407948 34155 280 ct., 4 2/5" x 8 2/5", 1-Ply, White, Pop-Up® Box 16800/cs.

15407952 34256 140 ct., 14 7/16" x 16 3/8", 1-Ply, White, Pop-Up® Box 2100/cs.

D. KIMTECH SCIENCE® PRECISION WIPES TISSUE WIPERS KIMBERLY-CLARK

An economical choice for general low-lint cleaning tasks. Soft and absorbent for general cleaning tasks. Anti-static dispensing reduces lint. Coated packaging helps protect wipes from spills.

15405515 05514 140 ct., 15" x 16 4/8", 1-Ply, White, Pop-Up® Box 15/cs.

E. KLEENEX® HAND TOWELS KIMBERLY-CLARK

Hygienic, one-at-a-time dispensing. No more messy stacks of towels on your counter. Water-resistant coating on box to prevent box from getting wet. Meets EPA Standards of minimum 40% post-consumer waste content for towels.

15401701 01701 120 ct., 9" x 10 1/2", White, Pop-Up® Box 2160/cs.

F. KLEENEX® ULTRA-SOFT HAND TOWELS KIMBERLY-CLARK

Say goodbye to soggy, messy stacks of paper hand towels. Now you've got a more convenient, hygienic countertop towel solution: With super premium softness, cloth-like feel and a contemporary striped designer box, the Ultra Soft towels provide an ultra premium alternative to cloth towels. Ideal replacement for airlaid guest towels or cloth hand towels; eliminates the cost of laundering.

15401268 11268 70 ct., 9" x 10 1/2", White, Pop-Up® Box 18/cs.

G. SCOTT® RAGS IN A BOX KIMBERLY-CLARK

Soft, absorbent towels that perform like a cloth. Packed in POP-UP® Box with handle to keep rags clean while carrying to job site.

15405260 75260 200 ct., 10" x 13", White, Pop-Up Box 1600/cs.

H. SCOTT® SHOP TOWELS KIMBERLY-CLARK

Easily absorbs liquids, oils, and grease. Super strong, works when wet. Ideal for changing oil, refilling fluids and general automotive maintenance. Fits on a standard towel holder for convenient dispensing of a fresh, clean towel.

15401082 75147 55 ct., Blue 12/cs.

I. WETTASK® WIPERS KIMBERLY-CLARK

The WetTask® refillable wet wiping system is ideal for critical tasks in healthcare and clean manufacturing environments. Use as an alternative to using a spray bottle or open bucket in combination with a rag. Combines all steps into one. Choose the wiper that works best for your task.

15406212 06211 90 ct., 12" x 12 1/2", White, For Disinfectants & Sanitizers 540/cs.

Wipers



A. WYPALL® TOWELS & RAGS

KIMBERLY-CLARK

L10 Sani-Prep Dairy Towels

Great for cleaning glass, wiping up spills, cleanup in light-duty manufacturing settings and general wiping tasks. Made with new absorbency pockets to help absorb more water faster.

15401772	01772	110 ct., 9" x 10 ¹ / ₂ ", White, Pop-Up® Box	1980/cs.
15401770	01770	200 ct., 9 ¹ / ₂ " x 10 ¹ / ₂ ", White, S-Fold	2400/cs.

L20 Kimtowels®

New patented technology creates absorbency pockets to help absorb more water faster. Textured side for cleaning power. Contains no binders or glues. Features multi-ply capacity for large spills.

15407033	47033	88 ct., 9 ¹ / ₁₀ " x 16 ⁴ / ₅ ", Tan, Pop-Up® Box	880/cs.
15409960	58399	176 ct., 12 ¹ / ₂ " x 16 ⁴ / ₅ ", Tan, Brag® Box	176/cs.

L40 Professional Towels

Towels that are strong enough to wipe off equipment, yet soft enough for personal use. Ideal for health clubs, mining/manufacturing and schools.

15405770	05770	45 ct., 12" x 23", White, 1/4 Fold	540/cs.
----------	-------	------------------------------------	---------

X50 Foodservice Towels

Versatile and reusable towels that are strong, yet soft. Made with Hydroknit® fast absorbing material for better cleaning performance.

15406053	06053	200 ct., 12 ¹ / ₂ " x 23 ¹ / ₂ ", White, 1/4 Fold	200/cs.
----------	-------	---	---------

X70 Foodservice Towels

Versatile and reusable. Ideal for all of your general cleaning needs. Strong yet soft cloth-like feel. Textured pattern helps trap and pick up food particles. Durable and machine washable. Rinses clean in sanitizing solution.

15405927	05927	300 ct., 12 ¹ / ₂ " x 23 ¹ / ₂ ", Blue, 1/4 Fold	300/cs.
15402520	592520	300 ct., 12 ¹ / ₂ " x 23 ¹ / ₂ ", White	300/cs.

X70 Workhorse® Manufactured Rags

Durable one-ply, absorbent rags that stay strong for better cleaning performance. Reusable, long-lasting performance. Cleans oil, grime and solvents with just one wipe. Made with high-tech Hydroknit® fast-absorbing material.

15404145	41455	100 ct., 9 ¹ / ₁₀ " x 16 ⁴ / ₅ ", White, Pop-Up® Box	1000/cs.
15404160	41600	870 ct., 12 ¹ / ₂ " x 13 ² / ₅ ", White, Jumbo Roll	870/ea.
15400425	41200	76 ct., 12 ¹ / ₂ " x 14 ² / ₅ ", White, 1/4 Fold	912/cs.
15404130	41300	152 ct., 12 ¹ / ₂ " x 16 ⁴ / ₅ ", White, Brag® Box	152/cs.

X80 Foodservice Towels

Versatile and reusable foodservice towels featuring Kimfresh® antimicrobial treatment. Strong yet soft towels are ideal for all general cleaning foodservice needs. Durable and machine washable. Rinse clean in sanitizing solution.

15406280	06280	150 ct., 12 ¹ / ₂ " x 23 ¹ / ₂ ", White, 1/4 Fold	150/cs.
----------	-------	---	---------



B. WYPALL® WIPERS

KIMBERLY-CLARK

L10 Utility Wipes

Great for cleaning glass, wiping up spills, cleanup in light-duty manufacturing settings and general wiping tasks. Made with new absorbency pockets to help absorb more water faster.

15405320	05320	125 ct., 9" x 10 ¹ / ₂ ", White, 1-Ply, Pop-Up® Box	2250/cs.
----------	-------	---	----------

L30 Economizer Wipers

Specifically designed to replace airlaid wipers, which have pool-prone pore areas. Ideal for a variety of light-duty maintenance, processing and janitorial wiping tasks.

15400356	05820	300 ct., 9 ¹ / ₅ " x 15 ¹ / ₅ ", White, Center Pull Roll	600/cs.
15405800	05800	100 ct., 9 ¹ / ₅ " x 16 ² / ₅ ", White, Pop-Up® Box	800/cs.
15400355	05816	120 ct., 9 ¹ / ₅ " x 16 ² / ₅ ", White, Pop-Up® Box	720/cs.
15405812	05812	90 ct., 12 ¹ / ₂ " x 14 ² / ₅ ", White	1080/cs.

L40 Wipers

Features our unique DRC (double re-creped) base sheet technology. An outstanding general purpose wiper with good performance in a wide range of industrial cleaning and personal wiping tasks. Easily absorbs liquids, lubricants, and oils. Soft enough for use on face and hands.

15405790	05790	100 ct., 9 ¹ / ₅ " x 16 ² / ₅ ", White, Pop-Up® Box	900/cs.
15405796	05796	200 ct., 10" x 13 ¹ / ₅ ", White, Center Pull Roll	2/200/cs.
15404620	03046	90 ct., 10 ¹ / ₅ " x 10", White, Pop-Up® Box	9/cs.
15405027	05027	70 ct., 11" x 10 ² / ₅ ", White, Roll	1680/cs.
15400571	05701	56 ct., 12 ¹ / ₂ " x 14 ² / ₅ ", White, 1/4 Fold	1008/cs.
15405776	05776	56 ct., 12 ¹ / ₂ " x 14 ² / ₅ ", Blue, 1/4 Fold	672/cs.



CLEANING TOOLS

Wipers



A. WYPALL® WIPERS (CONT.)

KIMBERLY-CLARK



X50 Wipers

Strong and sensible. These economical, extended use wipers pick up where the competition falls apart. Combines versatile performance with economical design. Ideal for manufacturing, healthcare and transportation environments. At least 25% more sheets than leading competitor to tackle a variety of jobs. Reinforced for strength when wet or dry. Hydroknit® fabric eliminates adhesives and binders.

15403550 83550 176 ct., 9¹/₁₀" x 12¹/₂", White 1760/cs.

X60 Teri® Reinforced Wipers

Reinforced wipers bring the absorbing power of Hydroknit® technology to a lighter weight wiper. Reinforced for extra scrubbing and cleaning power. Tough enough for big jobs but soft enough for face and hands.

15401150 35411 130 ct., 9¹/₂" x 13²/₅", Blue, Small Roll 1560/cs.

15409050 34790 126 ct., 9¹/₁₀" x 16¹/₅", White, Pop-Up® Box 1260/cs.

15404955 34955 1100 ct., 12¹/₂" x 13²/₅", White, Jumbo Roll 1100/cs.

15404015 34015 180 ct., 12¹/₂" x 16¹/₅", White, Brag® Box 180/cs.

X80 Wipers

Made with Hydroknit® fast-absorbing material, providing oil and water absorbency. Ideal for heavy-duty parts wiping, prepping many work surfaces with solvents, wiping up metal shavings and cleaning rough surfaces.

15401049 41048 80 ct., 9¹/₁₀" x 16¹/₅", White, Pop-Up® Box 400/cs.

15401043 41043 475 ct., 12¹/₂" x 13²/₅", Blue, Jumbo Roll 475/cs.

15404105 41055 475 ct., 12¹/₂" x 13²/₅", Red, Jumbo Roll 475/cs.

15401025 41025 475 ct., 12¹/₂" x 13²/₅", White, Jumbo Roll 475/cs.

15400346 41026 50 ct., 12¹/₂" x 14¹/₅", White, 1/4 Fold 200/cs.

15401041 41041 160 ct., 12¹/₂" x 16¹/₅", Blue, Brag® Box 160/cs.

B. TORK® ADVANCED WIPERS

SCA TISSUE



430 Wipers

Highly absorbent offering great wipe dry capabilities. Softness gives it a cloth-like feel. Strong and durable, won't tear easily. This product contains 100% synthetic and virgin fibers.

14102127 192127 100 ct., 9¹/₂"W x 16¹/₂"L, White, Tall Pop-Up 800/cs.

Cuisine Foodservice Wipers

Heavy-duty wipers for use around uncooked food in the kitchen and back of the house. Easy-to-use Tork® color-coded foodservice wipers prevent cross contamination by ensuring that the right wipers are always used for the right tasks. This product contains 100% synthetic and virgin fibers. One-ply.

14102191 192191 150 ct., 13"W x 24"L, White/Red Stripe, 1/4 Fold 150/cs.

C. TORK® PREMIUM 520 MULTIPURPOSE CLOTHS

SCA TISSUE



Made of cellulose and synthetic fibers. Won't break down with water, solvents or detergent based chemicals. Very absorbent so you'll use fewer wipes with faster results. This product contains 100% synthetic and virgin fibers.

14101378 520378 140 ct., 15" x 16¹/₂", Gray, Folded 700/cs.

14100337 520337 500 ct., 12²/₃" x 15", Gray, Centerfeed, Heavy-Duty 390/cs.

D. TORK® UNIVERSAL WIPERS

SCA TISSUE



320 Wipers

Two-ply wipers with increased capacity for absorbency. This product contains 100% recycled fibers. EcoLogo® Certified.

14100307 192125A 125 ct., 9" x 10¹/₄", White, Pop-Up Box 1980/cs.

330 Wipers

Soft and non-abrasive providing protection to delicate surfaces. Two-ply cellulose absorbs four times its weight. Solvent-resistant and long lasting offering faster and more effective wiping. This product contains 100% recycled fiber.

14102215 130211B 800 ct., 9" x 15³/₄" Sheets, White, Centerfeed 2/cs.

E. ULTRAWIPES

ZEP



Strong, reusable, lint-free wiper. This solvent-resistant non-woven cloth is excellent for glass, chrome, metal, and vinyl surfaces. Use again and again for hands, tools, and equipment. Use wet or dry.

75070146 895601 Blue 450/cs.

Chemical Wipes



CHEMICAL WIPES

A. CLOROX® DISINFECTING WIPES

CLOROX

The quick and easy way to clean and disinfect anytime and anywhere. Pre-moistened with cleaners and disinfectants, these handy household wipes are ready-to-use. Just wipe, toss and you're done. Bleach-free formula kills 99.9% of bacteria, including Staph and Salmonella. Ideal for day care centers, offices, schools and restaurants.

38381665	01665	9 ct., Travel Pack	24/cs.
38381593	01593	35 ct., Fresh Scent	12/cs.
38381594	01594	35 ct., Lemon Fresh Scent	12/cs.
38380083	30112	3-Pack of 35 ct., Lemon Fresh & Fresh Scent	15/cs.
38385949	15949	75 ct., Fresh Scent	6/cs.
38381686	01686	75 ct., Orange Scent	6/cs.
38380272	01761	75 ct., Lavender Scent	6/cs.
38385948	15948	75 ct., Lemon Fresh Scent	6/cs.
38380082	01599	2-Pack of 75 ct., Lemon Fresh & Fresh Scent	12/cs.



B. CLOROX® HEALTHCARE™ BLEACH GERMICIDAL WIPES

CLOROX

The fastest EPA-registered kill time for Clostridium difficile spores. One-step disinfectant cleaner designed for general cleaning and disinfecting hard, non-porous environmental surfaces in healthcare facilities. Ready-to-use, hospital-grade disinfectant. Excellent surface coverage. Tested for surface safety on common healthcare surfaces and equipment. Anticorrosion agent ensures compatibility with many hospital-grade surfaces, including: stainless steel, porcelain, glass, plastic, glazed ceramic. Contains the power of Clorox® bleach.

38385309	35309	70 ct.	420/cs.
38380032	30358	110 ct.	220/cs.
38380031	30359	110 ct., Refill	220/cs.



C. GREEN WORKS® NATURALLY DERIVED COMPOSTABLE CLEANING WIPES

CLOROX

Powerful cleaning in the convenience of a wipe. Green Works® cleaning wipes help make cleaning easier on you and Mother Nature. With the increasing number of "green" cleaners on the market, it isn't always easy to determine just how natural they truly are. Usage: schools, offices, restaurants. Removes grease, grime, dirt and soils. Safe to use on a wide variety of surfaces.

38380380	30380	62 ct.	384/cs.
-----------------	-------	--------	---------



D. FABULOSO® ALL PURPOSE WIPES

COLGATE-PALMOLIVE

Premoistened multi-use wipes. Effective for a wide variety of cleaning applications. Powerful commercial-strength formula. Safe for use on stainless steel, tubs, sinks, chrome, porcelain, doors, tables and washable walls.

11903039	53039	100 ct., 7" x 8", Lavender	600/cs.
-----------------	-------	----------------------------	---------



E. MURPHY® OIL SOAP WIPES

COLGATE-PALMOLIVE

Safely and easily removes dust, dirt and grime. No dulling residue. Ideal for cleaning wood furniture, kitchen cabinets and tables, doors and wood trim. Does not contain any chemicals or solvents that are harmful to wood surfaces. Cleans away wax build-up. Handy resealable pouch.

11905901	25901	18 ct.	216/cs.
-----------------	-------	--------	---------



F. OXIVIR® TB WIPES

DIVERSEY

Convenient-to-use broad-spectrum, hospital-grade disinfectant wipes that disinfect hard, non-porous surfaces in just 60 seconds. Kills a wide variety of organisms of concern including TB, Norovirus, Hepatitis B, Hepatitis C and the drug-resistant organisms MRSA and VRE. Excellent environmental profile, and are essentially non-irritating to eyes and skin.

15209516	4599516	160 ct.	570/cs.
-----------------	---------	---------	---------

G. PLEDGE® MULTI-SURFACE CLEAN & DUST WIPES

DIVERSEY

Multi-surface cleaner in the convenience and portion control of a wipe.

15204629	CB214629	25 ct.	300/cs.
-----------------	----------	--------	---------



CLEANING TOOLS

Chemical Wipes



A. SCRUBBING BUBBLES® ANTIBACTERIAL BATHROOM WIPES DIVERSEY

Flushable bathroom wipes. Just wipe and flush the mess away. Pop-top canister helps keep wipes moist between uses. Convenient—quick and easy way to touch-up bathroom surfaces to a beautiful shine. Easy-to-use—simply grab a wipe, wipe-up stains from the toilet seat, rim, tank or other bathroom surfaces and flush the mess away. Kills odor-causing bacteria.
15202237 CB232237 28 ct. 252/cs.

B. CLEAR REFLECTIONS® GLASS & SURFACE WIPES DYMON

Combines the patented residue-free glass cleaner formula with a high quality, lint-free wipe to give your glass and surface a streak-free shine. This quick and easy one-step application has just the right amount of ammonia-free cleaner to keep glass and surfaces looking new. Withstands the demands of institutional, janitorial and industrial applications.
31128503 98528 90 ct. 540/cs.

C. LYSOL® DISINFECTING WIPES RECKITT BENCKISER

One-step cleaning and disinfecting in a premoistened towelette. Kills 99.9% of germs on hard, non-porous surfaces in 30 seconds. Air-tight canister package keeps wipes moist and effective, allows reclosure with wipe partially threaded.
58348114 81145 35 ct., Citrus 420/cs.
58341146 81146 35 ct., Spring Waterfall 420/cs.
58347182 77182 80 ct., Lemon & Lime Blossom 6/cs.
58347925 77925 80 ct., Spring Waterfall 6/cs.
58344906 78849 110 ct., Citrus 6/cs.

D. LYSOL® DUAL ACTION DISINFECTING WIPES RECKITT BENCKISER

Dual action wipes with a scrubbing side that removes tough messes and a wiping side that kills 99.9% viruses and bacteria.
58348113 81143 28 ct., Citrus 420/cs.
58341700 81700 56 ct., Citrus 6/cs.

E. SANI PROFESSIONAL™ BRAND TABLE TURNERS™ SANI PROFESSIONAL

Pre-moistened disposable wipes are a quick, easy-to-use alternative to rags. Fast, effective, streak-free formula is ideal for restaurant use, dining tables, countertops, bar tops, porcelain and other hard surfaces.
49680030 A580FW 80 ct. 7" x 11½", Flow Wrap 960/cs.

F. SANI-CLOTH® DISINFECTING WIPES SANI PROFESSIONAL

Kills Flu Virus (Influenza A2/Hong Kong). Kills 99.9% of bacteria in 15 seconds. Also effective against Escherichia Coli (E. coli), Salmonella enterica (Salmonella), Staphylococcus aureus (Staph) and Pseudomonas aeruginosa.
49680035 P15472 160 ct., 6" x 6¾" 12/cs.
49680039 P22884 200 ct., 5¾" x 7½" 1200/cs.

G. SANI-WIPE® NO-RINSE SURFACE SANITIZING WIPES SANI PROFESSIONAL

FDA Food Code compliant formula for use on surfaces that come in contact with food. Tested and proven to kill E. coli, Staph and Shigella boydii on food contact surfaces in 60 seconds. Excellent for sanitizing hard, non-porous surfaces.
49684384 Q94384 100 ct., 7¾" x 10½" 6/cs.

H. SAFETY TOWELS SIMPLE GREEN

Pre-moistened with non-toxic and biodegradable Crystal Simple Green. Designed with the industrial cleaning strength of Crystal Simple Green infused into thermally bonded, dual textured, lint-free polypropylene towels.
73430002 13351 75 ct., 10" x 11¾" 450/cs.

I. PRE-MOISTENED STAINLESS STEEL POLISHING TOWELS ZEP

Heavy-duty Hydroknit® towels for use on stainless steel, chrome, and aluminum surfaces. Removes grease, fingerprints, water stains while brightening surfaces. Does not leave surface oily and wet to attract dust.
75070138 R09301 72 ct. 6/cs.

Sponges



SPONGES

A. PRIME SOURCE® CELLULOSE SPONGES PRIME SOURCE®

Cellulose block sponges.

75004164	75004164	3 ³ / ₈ " x 6 ¹ / ₄ "	48/cs.
75004169	75004169	4 ¹ / ₈ " x 6 ¹ / ₄ ", Individually Wrapped	24/cs.



B. PRIME SOURCE® CONTOUR™ SPONGE N' SCRUBBER PRIME SOURCE®

Blue non-scratch cleaning pad treated with Ultra-Fresh®, an antimicrobial treatment.

75004168	75004168	Blue/Yellow	20/cs.
----------	----------	-------------	--------



C. PRIME SOURCE® SCRUBBING SPONGES PRIME SOURCE®

Regular-Duty

Scouring pad and cellulose sponge combination. Excellent for counter tops, wall switch plates and around door knobs. Use in combination with cleaning solutions for faster action.

75004166	75004166	3 ⁷ / ₁₆ " x 6 ¹ / ₁₆ ", Green/Yellow	40/cs.
----------	----------	---	--------

Walnut

An innovative cleaning pad with organic crushed walnut shells. Walnut is a natural abrasive that provides aggressive cleaning action for virtually any surface. Use on ceramic, porcelain, stainless steel, painted surfaces, and more.

75004167	75004167	3 ⁷ / ₁₆ " x 6 ¹ / ₁₆ ", Walnut	20/cs.
----------	----------	---	--------



D. NIAGARA™ MEDIUM-DUTY SCRUB SPONGE 74N 3M

A dual action, medium-duty cleaning pad/sponge for most common cleaning jobs. Typical applications; walls, tables, fixtures, countertops, floors.

66551074	04801119428	6 ¹ / ₁₀ " x 3 ³ / ₈ ", Yellow/Green	20/cs.
----------	-------------	--	--------



E. SCOTCH-BRITE™ SCRUBBING SPONGES 3M

63 Light-Duty

Light-duty cleaning pad/sponge that won't scratch or mar most surfaces. Typical applications: stainless steel, glass, ceramic, fine china, porcelain, countertops and non-stick surfaces.

66556303	61500110368	3 ³ / ₈ " x 6 ¹ / ₁₀ " x 7 ¹ / ₁₀ ", Yellow/White	20/cs.
----------	-------------	---	--------

74 Medium-Duty

Scouring pad on one side for scrubbing and cleaning and cellulose sponge on the other side to wipe up spills and messes and carry cleaning solutions.

66550744	61500110376	3 ³ / ₈ " x 6 ¹ / ₁₀ " x 7 ¹ / ₁₀ ", Green/Yellow	20/cs.
----------	-------------	---	--------



F. SCOUR SPONGE CCP

Excellent for spot cleaning and general scrubbing.

27600951	14	6 ¹ / ₄ " x 3 ³ / ₈ " x 7 ⁷ / ₈ ", Yellow/Green	40/cs.
----------	----	---	--------



G. SCRUBBING SPONGES CCP

Light-Duty

Utility cellulose sponge with light-duty scouring pad attached. Excellent for cleaning countertops, appliances, ceramic tile, laminates, railings, sinks, tubs and showers.

27603535	23535	3 ⁷ / ₁₆ " x 6 ¹ / ₄ ", White/Yellow	20/cs.
----------	-------	--	--------

Medium-Duty

Utility cellulose sponge with medium-duty scouring pad attached. Cellulose sponge absorbs water while the green abrasive pad helps cleaners work even better. Works well on sinks, countertops, tables, walls, pots and pans. Rinses clean easily.

27600940	20946	3 ⁷ / ₁₆ " x 6 ¹ / ₄ ", Green/Yellow	8/5/cs.
----------	-------	--	---------

27603107	23107	3 ⁷ / ₁₆ " x 6 ¹ / ₄ ", Green/Yellow	20/cs.
----------	-------	--	--------

27600439	20944	3 ⁷ / ₁₆ " x 6 ¹ / ₄ ", Green/Yellow	40/cs.
----------	-------	--	--------



H. S.O.S.® ALL SURFACE SCRUBBER SPONGES CLOROX

Scrubber sponges that cut through the toughest messes on all surfaces. The dependable scrubber for your everyday cleaning jobs. Safe for most delicate bathroom and kitchen surfaces including marble, ceramic, tile and glass. Teflon® pan-friendly. Bigger and thicker than ordinary scrubber sponges and the angled shape gets into hard-to-reach places.

38381251	91028	3 ct., All-Surface	24/cs.
----------	-------	--------------------	--------

38381267	91029	3 ct., Heavy-Duty	24/cs.
----------	-------	-------------------	--------



Scouring Pads



SCOURING PADS

A. PRIME SOURCE® KLEENFAST® HEAVY-DUTY PADS PRIME SOURCE®

For heavy-soiled traffic areas such as halls, stairs around stoves and fryers. Easily removes old finish and wax build-up.

750044675	75004467	4 1/2" x 10", Brown	5/bx.
75004467	75004467	4 1/2" x 10", Brown	20/cs.

B. PRIME SOURCE® SCOURING PADS PRIME SOURCE®

Medium-duty scouring pads are ideal for cleaning equipment and removing grime from surfaces. Heavy-duty scouring pads are ideal for the toughest cleaning jobs.

Medium-Duty			
750041615	75004161	6" x 9", Green	10/pk.
75004161	75004161	6" x 9", Green	60/cs.
Heavy-Duty			
750041605	75004160	6" x 9", Green	10/pk.
75004160	75004160	6" x 9", Green	60/cs.

C. PRIME SOURCE® ULTRA-DUTY POT & PAN SCOURING PAD PRIME SOURCE®

Easily removes the most stubborn, baked-on deposits from pots and pans. Replaces scrapers and metal sponges for tough cleaning jobs.

75004163	75004163	3 1/2" x 5", Dark Green	36/cs.
----------	----------	-------------------------	--------

D. PRIME SOURCE® WALNUT SCOURING PAD PRIME SOURCE®

Scratch-resistant scouring pad for cleaning delicate items.

75004162	75004162	6" x 9", Walnut	60/cs.
----------	----------	-----------------	--------

E. NIAGARA™ MEDIUM-DUTY HAND PAD 96N 3M

The original synthetic scouring pad and is still the performance leader. Ideal for most common cleaning jobs.

66559696	04801118196	6" x 9", Green, Cash N' Carry	60/cs.
----------	-------------	-------------------------------	--------

F. SCOTCH-BRITE™ SCOURING PADS 3M

88 Pot 'N Pan Handler

Thick, open mesh construction. Rinses out easily, doesn't splinter and won't rust. Can replace stainless steel scrubbers. More effective than most pot scrubbing pads. Ideal for cleaning stubborn cheeses and thick sauce deposits on pots and pans.

66558800	61500015153	3 1/2" x 5", Blue	40/cs.
----------	-------------	-------------------	--------

96 General Purpose

The original synthetic scouring pad is long lasting, non-rusting and resilient. Use it for everyday cleaning of most cooking utensils and equipment.

66559600	70071592383	6" x 9", Green	60/cs.
----------	-------------	----------------	--------

Power Pads 2000

Scours up to four times faster than commercial scouring products. Scratches surfaces up to eight times less than other medium/heavy-duty commercial scouring products.

66552001	70070724235	5 1/2" x 3 9/10", Blue	60/cs.
----------	-------------	------------------------	--------

86 Heavy-Duty

Open construction pad with tough fibers and abrasives make fast work of heavy-duty cleaning jobs. Use in the kitchen to replace scrapers, steel wool and metal sponges.

66558600	61500025921	6" x 9", Green	36/cs.
----------	-------------	----------------	--------

G. JIF-Y-CLEAN™ 49A SCOURING PAD CCP

Light-duty white cleaning pad. Non-abrasive for light clean-up jobs on ceramic, porcelain, stainless steel, and painted surfaces.

27600078	20948	6" x 9", White	60/cs.
----------	-------	----------------	--------

H. KLEENFAST® UTILITY PADS CCP

A convenient, integrated system that combine holders and different pads to handle a variety of cleaning tasks.

27600460	20968	4 1/2" x 10", Light-Duty, White	20/cs.
27600969	20969	4 1/2" x 10", Heavy-Duty, Brown	20/cs.

Scouring Pads/Pad Holders



A. SCOURING PADS CCP

Light-Duty

Non-abrasive for light clean-up jobs on ceramic, porcelain, stainless steel, and painted surfaces.

276001375 20950 6" x 9", White 20/cs.

Medium-Duty

Scouring and cleaning pad for areas where aggressive cleaning is required.

27600522 20941 6" x 9", Green 60/cs.

Medium-Duty

A general purpose cleaning pad, designed for daily cleaning of pots, pans, utensils, equipment and floors. Great for cleaning fresh vegetables. Not recommended for use on certain soft plastics, fine china or polished steel.

27600835 MD6920 6" x 9", Green 20/cs.

27600820 MD69 6" x 9", Green 60/cs.

Heavy-Duty

Use where heavy aggressive action is required. Attach to mop for removing scuff marks off tile floors. Ideal for grimy maintenance equipment.

276025845 22584 6" x 9", Green 12/cs.

Heavy-Duty

Very abrasive pad. Effective for removing heavy baked-on deposits, such as rust and corrosive deposits from metal surfaces.

27600783 HD4669 4" x 6", Dark Green 40/cs.

27600184 HD69 6" x 9", Dark Green 60/cs.

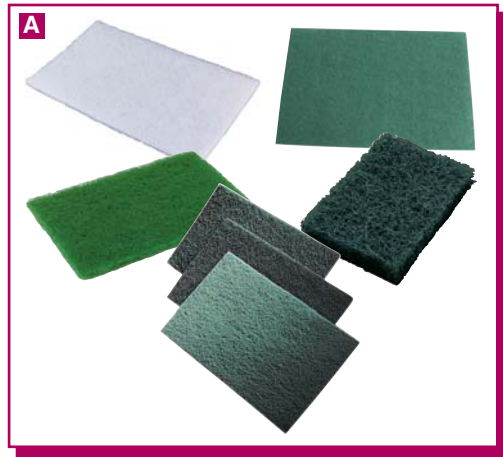

B. WALNUT PAD™ SCOURING PAD CCP

Scratch-resistant with aggressive cleaning action. Safe to use on polished stainless steel, ceramic, copper, porcelain and painted surfaces. Contains organic crushed walnut shells.

27600452 29514 6" x 9" 20/cs.

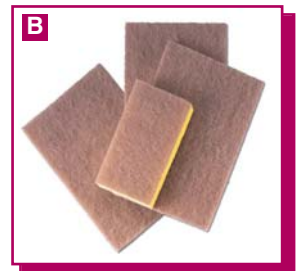

C. MR. CLEAN® MAGIC ERASER PROCTER & GAMBLE

Original eraser pads easily remove scuff marks and dirt from walls, baseboards, and floors. Water-activated micro-scrubbers reach into surface grooves and lift away built up grease and soap scum. Removes more grime than the leading all-purpose spray cleaner without any harsh chemicals.

16902027 82027 4 ct. 24/cs.

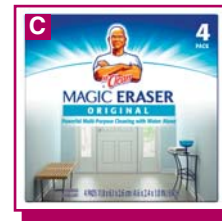

D. MR. CLEAN® MAGIC ERASER PROCTER & GAMBLE

A disposable, soft cleaning pad that acts just like an eraser with water alone. No fumes, gloves or chemicals required. It removes scuff marks and dirt from floors, walls and doors. Even removes tough crayon marks.

16906449 16449 30 ct. 30/cs.



E. HEAVY-DUTY SCOURING PAD ROYAL PAPER PRODUCTS

Tough fibers and abrasives make fast work of heavy-duty cleaning jobs. Flexible pad allows for easy removal of baked on foods in difficult corners and hard-to-reach places.

61700960 S960 6" x 9", Green 60/cs.



PAD HOLDERS

F. KLEENFAST® SWIVEL HOLDER KIT PRIME SOURCE®

For heavy-soiled traffic areas such as halls, stairs around stoves and fryers. Easily removes old finish and wax build-up. Kit includes one holder and two pads.

750044681 75004468 4 1/2" x 10" 1/ea.

75004468 75004468 4 1/2" x 10" 4/cs.



G. UNIVERSAL SWIVEL HOLDER KIT W/LOCK CCP

Swivels to reach both horizontal and vertical surfaces. Locking-grid holds pad firmly in place. Holds all Doodlebug™ or Kleenfast® utility pads.

276009311 20931 4 1/2" x 10" 1/ea.



CLEANING TOOLS

Steel Wool Pads/Metal Scrubbers/Griddle Cleaning



STEEL WOOL PADS

A. BRILLO® STEEL WOOL SOAP PAD CCP

Hotel size soap pad for heavy-duty cleaning of pots and pans. The special combination of metal fiber and soap dissolves stubborn grease and lifts off sticky food particles leaving a bright new shine.

27600020 29404 4" x 4", Boxed 120/cs.

B. S.O.S.® STEEL WOOL SOAP PAD CLOROX

The combination of steel shavings and powerful detergent in each pad makes quick work of grease and grime. Not for use on non-stick surfaces. Kitchen: stoves and broilers, glass bake ware, pots, pans and plates. Restrooms: tile countertops, glass shower doors, porcelain tubs and sinks. Outdoor: golf clubs, barbecue grills, rusty lawn furniture, tires and chrome bumpers.

38388320 88320 15 ct. 180/cs.



METAL SCRUBBERS

C. PRIME SOURCE® POT SCRUBBERS PRIME SOURCE®

Stainless steel pot scrubbers.

750042905	75004290	35 g	12/cs.
75004290	75004290	35 g	72/cs.
75004292	75004292	43 g	72/cs.
750042915	75004291	50 g	12/cs.
75004291	75004291	50 g	72/cs.



D. SCOTCH-BRITE™ STAINLESS STEEL SCRUBBER 3M

High quality stainless for tough cleaning chores, won't rust or splinter. Removes baked-on food from pots/pans, baking dishes, grills and ovens.

66550884 04801119084 1 3/4 oz. 12/cs.



E. 400 SERIES STAINLESS STEEL SCRUBBERS CCP

Manufactured from less expensive 400 series wire construction. These scrubbers have effective properties for the removal of baked-on deposits and other medium-duty jobs.

27602204	D204	35 g	72/cs.
276007885	D104	50 g	12/cs.
27600788	D104	50 g	72/cs.



GRIDDLE CLEANING TOOLS

F. PRIME SOURCE® GRIDDLE PAD PRIME SOURCE®

Griddle pad will do light cleaning and polish the grill surface to bring back shine. Griddle pad must be used with a griddle screen and holder. Pad allows articles from grill to soak up through the screen and prevents clogging.

750041655	75004165	4" x 5 1/2"	10/pk.
75004165	75004165	4" x 5 1/2"	500/cs.



G. SCOTCH-BRITE™ GRIDDLE POLISHING PAD 46 3M

Use between screen and holder to maximize screen life and minimize loading. Strong nylon web construction contains hard working abrasive for additional cleaning power.

66554802 70071593217 4" x 5 1/4" 60/cs.



H. SCOTCH-BRITE™ HEAVY-DUTY GRIDDLE CLEANING PAD 82 3M

Heavy-duty griddle cleaning pad with open web construction for the toughest jobs. Removes heavily burned-on food and grease to provide a spotless, shiny griddle in minutes.

66550049 04801108299 4 1/2" x 5 1/2" 4/cs.

Griddle Cleaning/Scrub Brushes/Counter Brushes



A. GRIDDLE PAD HOLDER CCP

Uniquely designed, manufactured from high heat-resistant plastic to protect hands from grease and burns. The gripping teeth hold the griddle pad firmly in place.
27600022 GPH10HR Blue 10/cs.



B. GRIDDLE PAD CCP

When used alone on a warm grill, this pad will do light cleaning and polish the grill surface to bring back the shine. A griddle pad must be used when using a griddle screen and holder. The pad allows particles from the grill to soak up through the screen and prevents the screen from clogging.
27600813 GP46 4" x 5 1/2" 60/cs.



C. GRIDDLE SCREENS CCP

For those times when you do not need to clean a heavily charred grill or for use after cleaning with a Grillbrick®. For more effective cleaning, use the griddle screen with a griddle pad. Grill should be 212°F or less. The pad allows the particles from the grill to soak up through the griddle screen and will help keep the screen from clogging. Choose any of our griddle pad holders to protect hands from grease and burns. Made in USA.
27600238 GS1020 4" x 5 1/2" 200/cs.
27600242 G35 4" x 5 1/2" 400/cs.



D. GRILBRIK® GRILL CLEANING BRICK CCP

Use safely on hot griddles without lifting griddle cure. Easy to use and cost effective. Film wrap acts as the holder. Virtually odor-free.
27601613 GB12 8" x 4" x 3 1/2" 12/cs.



GENERAL PURPOSE/SCRUB BRUSHES

E. PRIME SOURCE® UTILITY SCRUB BRUSH PRIME SOURCE®

Grips and bristles are designed to work in the most comfortable position and provide the most efficient cleaning. 2" trim.
75004918 75004918 8"L, Plastic Block w/Tampico Bristles 12/cs.



F. UTILITY SCRUB BRUSHES CARLISLE

Crimped polypropylene scrub brush is perfect for general use. Crimped filament for better solution holding capabilities.
63870588 3650500 8"L, Cream 12/cs.
63870503 36505L00 20"L, Cream 12/cs.



G. HAND SCRUB BRUSH RUBBERMAID

Plastic iron handle scrub brush with polypropylene fill.
17706482 6482 6"L, Cobalt 12/cs.

COUNTER BRUSHES

H. PRIME SOURCE® COUNTER BRUSHES PRIME SOURCE®

Counter brushes are ideal for removing fine particles.
75004923 75004923 8"L, Plastic Bristles 12/cs.
750098601 75009860 8"L, Polypropylene Bristles 1/ea.
75004924 75004924 8"L, Tampico Bristles 12/cs.



I. PRIME SOURCE® DUSTING BRUSH W/HANDLE PRIME SOURCE®

The flagged tips of this polystyrene bristle make this the ideal tool for fine dust and dirt retention on smooth surfaces. It is great for shops, light industrial and commercial uses. Structural foam block.
750049601 75004960 8"L 1/ea.
75004960 75004960 8"L 12/cs.



J. COUNTER BRUSHES RUBBERMAID

Perfect for quick clean-ups. All plastic brush blocks.
17706342 6342 12 1/2"L, Flagged Polypropylene 6/cs.
17706341 6341 12 1/2"L, Tampico 6/cs.



CLEANING TOOLS

Bowl & Automotive Brushes



BOWL BRUSHES

A. PRIME SOURCE® BOWL BRUSH PRIME SOURCE®

Properly designed brush for sanitary cleaning of toilet bowls make the cleaning chore faster and easier.

75004917 75004917 15"L, Tampico 24/cs.



B. PRIME SOURCE® ECONOMY BOWL MOPS PRIME SOURCE®

Economical bowl mop with colorful plastic handle has a fast-drying, non-absorbent acrylic yarn puff to gently wash porcelain fixtures.

75004961 75004961 12"L, White, Acrylic 1/ea.
 75004961 75004961 12"L, White, Acrylic 144/cs.
 75009861 75009861 12"L, White, Nylon 1/ea.



C. BOWL BRUSH CARLISLE

Non-scratching bristles are not affected by standard bowl cleaners.

638705541 3633 21"L 1/ea.



D. CONTOURED BOWL BRUSH W/CADDY CCP

Polypropylene fibers are ideal for light scrubbing of toilet bowls, as well as removing buildup at the water line. Perfect for office and light industrial areas.

276006001 J506000 14"L, Comes w/Caddy 1/ea.



E. ECONOMY BOWL MOP CCP

Economical bowl mop with plastic handle has a fast-drying, non-absorbent acrylic yarn puff to gently wash porcelain fixtures.

276051151 J510000 12"L 1/ea.



F. TOILET BOWL BRUSH CCP

Toilet bowl brush.

27607017 CJ507017 18"L 12/cs.

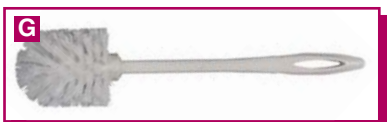

G. TOILET BOWL BRUSH RUBBERMAID

Synthetic polypropylene bristles and plastic handle resist stains and odors.

177063101 6310 14½"L 1/ea.
 17706310 6310 14½"L 24/cs.



AUTOMOTIVE BRUSHES

H. PRIME SOURCE® DUAL SURFACE® FLO-THRU WASH BRUSH PRIME SOURCE®

Dual Surface® block design keeps the bristles working at almost every angle.

75004777 75004777 10"L 12/cs.



I. PRIME SOURCE® FLO-THRU FLAGGED VEHICLE WASH BRUSH PRIME SOURCE®

Vehicle wash brush has a flo-thru design that insures a constant flow of water with polystyrene bristles and vinyl bumper.

75004757 75004757 10"L 12/cs.

Floor Brushes/Corn Brooms



FLOOR BRUSHES

A. PRIME SOURCE® DUAL SURFACE® FLOOR BRUSH

PRIME SOURCE®

Features three surfaces and end bristles for efficiently cleaning flat surfaces, in and around corners and along baseboards.

750047151	75004715	10", Blue, Plastic Block w/PPY Bristles	1/ea.
75004715	75004715	10", Blue, Plastic Block w/PPY Bristles	6/cs.



B. SWIVEL SCRUB® DECK BRUSH

PRIME SOURCE®

Swivel Scrub® for heavy scrubbing of built-up floor finish in tight areas and baseboards. Excellent for hard-to-reach areas.

750049191	75004919	8", Plastic Block w/PPY Bristles	1/ea.
75004919	75004919	8", Plastic Block w/PPY Bristles	4/cs.



C. DUAL SURFACE® FLOOR SCRUB

CARLISLE

Floor scrubs are made with three different brush surfaces for cleaning at different angles. The split-shape is efficient for cleaning flat surfaces, under counters, around equipment, and along baseboards. Non-absorbent plastic blocks and synthetic bristles wash easily and prevent gathering of mold and mildew. Threaded to accept your choice of handles (not included).

63872200	4042200	10", Yellow, w/Side Bristles	12/cs.
----------	---------	------------------------------	--------



D. FLOOR DRAIN BRUSH SYSTEM

CARLISLE

Special female threaded handle accepts floor drain brushes only to prevent cross-contamination. Long lasting bristles and handle (sold separately) stand up to rugged use. Drain handle imprinted with "USE FOR FLOOR DRAIN ONLY" in English and Spanish to prevent contact with food and serving utensils.

63870399	40146	Brush Only, 3"	6/cs.
63870398	40237	Handle Only, 48"	6/cs.



E. SPARTA® HI-LO™ FLOOR SCRUB

CARLISLE

Made with three different brush surfaces for cleaning at different angles. The split-shape is efficient for cleaning flat surfaces, under counters, around equipment and along baseboards. Non-absorbent plastic block and synthetic bristles wash easily and prevent gathering of mold and mildew. Threaded to accept your choice of handle (not included). 10" x 4 1/2" x 3 1/2".

63879309	4042302	White	12/cs.
----------	---------	-------	--------



F. FLOOR SCRUB

RUBBERMAID

Plastic block with bi-level polypropylene fill.

17700869	6337	10", Blue	6/cs.
----------	------	-----------	-------



CORN BROOMS

G. PRIME SOURCE® CLEAN SWEEP™ BROOMS

PRIME SOURCE®

Whisk Broom

Features double-stitched, nylon cord bound fibers that are wrapped onto wood handle with hang cap. Designed for long life and efficient sweeping.

75004906	75004906	Black Stitch, 2-Stitch, Blend	12/cs.
750098061	75009806	10"	1/ea.

Toy Broom

Toy corn blend broom.

75004907	75004907	Toy Broom	12/cs.
----------	----------	-----------	--------

Lobby Brooms

100% corn brooms.

750049051	75004905	34"	1/ea.
75004905	75004905	34"	12/cs.



Corn Brooms



A. PRIME SOURCE® CLEAN SWEEP™ BROOMS (CONT.) PRIME SOURCE®

Fan Maid Broom

High quality blend corn broom. Durable upright broom designed for long life and efficient sweeping. Four stitches. 7/8" dia. wood handle.

750049011	75004901	18#	1/ea.
75004901	75004901	18#	6/cs.

Warehouse Brooms

Six rows of stitching and metal band.

750049021	75004902	28#	1/ea.
75004902	75004902	28#	6/cs.
750049031	75004903	32#	1/ea.
75004903	75004903	32#	6/cs.
75004904	75004904	32#	6/cs.



B. PRIME SOURCE® NATURAL CORN BROOMS PRIME SOURCE®

100% natural corn blend brooms. High bristle fill count for excellent durability and value.

750098071	75009807	Lobby Broom, 40"	1/ea.
75009807	75009807	Lobby Broom, 40"	12/cs.
750098011	75009801	Housekeeping Broom - 4 Sew, 55"	1/ea.
75009801	75009801	Housekeeping Broom - 4 Sew, 55"	12/cs.
750098041	75009804	Janitor Broom - 5 Sew, 56"	1/ea.
75009804	75009804	Janitor Broom - 5 Sew, 56"	12/cs.



C. CLEAN SWEEP™ JANITOR BROOM CCP

Janitor broom with five rows. Use for industrial and janitorial sweeping.

276006811	91522	Natural Blend	1/ea.
-----------	-------	---------------	-------



D. CORN BROOM RUBBERMAID

Designed for rugged indoor/outdoor cleaning. 100% natural broom corn fibers for long life and effective pick up. Remove fine dirt from even or rough surfaces. Hand-selected, heavy-duty lacquered pine handle.

177063811	6381	24#, Red Handle	1/ea.
-----------	------	-----------------	-------



E. LOBBY PRO® LOBBY BROOM RUBBERMAID

100% corn broom. Three rows of stitching for added strength and durability. Sweeps fine or coarse material.

177007251	6373	8"W	1/ea.
17700725	6373	8"W	12/cs.



F. GOOD VALUE BROOM ZEPHYR

Lightweight broom combines quality and low price by using a substitute fiber called Nolina that is green, tough and pliable. Broom has Nolina in the center with a layer of quality broom corn on the outside. Lacquered handle with three sew stitching.

75080180	32018	Broom	12/cs.
----------	-------	-------	--------



G. WAREHOUSE BROOM ZEPHYR

Sturdily constructed on a heavy-duty amber lacquered handle. Heavy metal bands with three rows of stitching provide maximum strength and durability.

75080340	33034	Size 34	6/cs.
----------	-------	---------	-------

Angle Brooms



ANGLE BROOMS

A. PRIME SOURCE® ANGLE SWEEP™ ANGLE BROOMS

PRIME SOURCE®

Flagged angle brooms complete with handles.

750049101	75004910	10"W	1/ea.
75004910	75004910	10"W	12/cs.
750049111	75004911	12"W	1/ea.
75004911	75004911	12"W	12/cs.



B. PRIME SOURCE® DUO-SWEEP® ANGLE BROOMS

PRIME SOURCE®

No hood/shroud to break or gather soils leading to cross-contamination issues. Excellent balance to reduce sweeping fatigue. Two handle holes; one upright, one angled. Come equipped with wood handle.

750098111	75009811	Large, Flagged	1/ea.
75009811	75009811	Large, Flagged	12/cs.
750098121	75009812	Large, Unflagged	1/ea.
75009812	75009812	Large, Unflagged	12/cs.



C. O-CEDAR® MAXI-ANGLER BROOM

DIVERSEY

Big sweeping surface with angled cut for sweeping in hard to get corners or under furniture. Washable, natural color polystyrene-flagged tip bristles are unaffected by water, alkaline, acids, grease or oil and won't wear down, break or fall out. Plastic angled shroud has patented handle locking mechanism. Ribbed, coated aluminum handle for comfortable grip. 15/16" dia. standard threaded handle.

15200004	91351	12"W, Flagged	4/cs.
----------	-------	---------------	-------



D. BRUTE® ANGLED BROOM

RUBBERMAID

Ideal for cleaning hard-to-reach areas. Cut and shaped for easy sweeping. Flagged polypropylene fill with an aluminum handle.

17706385	6385	10 1/2"W	6/cs.
----------	------	----------	-------



E. LOBBY PRO® LOBBY BROOM

RUBBERMAID

Ideal for one-handed cleaning under tables, fixtures, and hard to reach areas. Ideal for use in malls, restaurants, and lobbies. Tough polypropylene with flagged bristles trap fine particles. Will not stain, discolor or absorb odors. Can be used wet or dry.

177078631	6374	7 1/2"W x 35"H	1/ea.
17707863	6374	7 1/2"W x 35"H	6/cs.



F. BBL™ ANGLE BROOM

ZEPHYR

Features sturdy, long-lasting plastic fiber bristles.

75089077	09077	Large	12/cs.
----------	-------	-------	--------

G. BIG-QIK™ ANGLE BROOM

ZEPHYR

Bristles are sturdy, long-lasting plastic fiber with miracle soft tips that dust and sweep all kinds of surfaces. Angle cut allows it to be used for corners, edges, under counters and in those tough to reach places. Electrostatic action holds dirt and dust. Head easily detaches for cleaning.

75080680	34068	13"W	6/cs.
----------	-------	------	-------



Floor Sweeps



FLOOR SWEEPS



A. PRIME SOURCE® FLOOR SWEEPS

PRIME SOURCE®

Fine Sweeps

Flagged polypropylene sweeps with hardwood blocks that remove dust and fine dirt particles with soft, lightly crimped and flagged filament. 3" trim. Use with tapered handle.

75009830	75009830	18"	12/cs.
750098311	75009831	24"	1/ea.
75009831	75009831	24"	12/cs.
750098321	75009832	36"	1/ea.
75009832	75009832	36"	6/cs.

Medium Sweeps

Medium sweeps with hardwood block. An excellent all around tool for smooth and medium surfaces. 3" trim, tampico fibers. Use with tapered handle.

750098401	75009840	18"	1/ea.
750098411	75009841	24"	1/ea.
75009841	75009841	24"	12/cs.
750098421	75009842	36"	1/ea.

Dual fill sweeps. 4" trim, polypropylene bristles with heavy centers and fine borders.

750098251	75009825	18"	1/ea.
75009825	75009825	18"	12/cs.
750098261	75009826	24"	1/ea.
75009826	75009826	24"	12/cs.
750098271	75009827	36"	1/ea.

Heavy Sweeps

Crimped sweeps.

750098331	75009833	18"	1/ea.
750098341	75009834	24"	1/ea.
75009834	75009834	24"	12/cs.
750098351	75009835	36"	1/ea.

Heavy sweep with 3" trim.

750098361	75009836	24"	1/ea.
-----------	----------	-----	-------

Heavy sweeps with stiff polypropylene bristles for added durability. 3 1/4" trim. Hardwood blocks. Use with tapered handle.

75009814	75009814	18"	12/cs.
75009815	75009815	24"	12/cs.
75009816	75009816	36"	6/cs.

Heavy sweep with natural palmyra for sweeping heavy debris. 4" trim. Use with tapered handle.

750098461	75009846	24"	1/ea.
-----------	----------	-----	-------

Street Sweeps

Perfect for wet and dry applications, street cleaning and construction crews. Use with tapered handle.

75004909	75004909	16", 5 1/8" Trim, Heavy Polypropylene	12/cs.
75004913	75004913	16", 6 1/4" Trim, Palmyra	12/cs.



B. PRIME SOURCE® GARAGE BROOMS

PRIME SOURCE®

Medium sweeps with hardwood blocks, 3" trim, tampico fibers.

750049141	75004914	18"	1/ea.
75004914	75004914	18"	12/cs.
750049151	75004915	24"	1/ea.
75004915	75004915	24"	12/cs.
750049161	75004916	36"	1/ea.
75004916	75004916	36"	6/cs.

Floor Sweeps/Broom Braces



A. PRIME SOURCE® VALUE LINE FLOOR SWEEPS PRIME SOURCE®

Flagged Polystyrene

75004930	75004930	18"	12/cs.
75004931	75004931	24"	12/cs.
750049321	75004932	36"	1/ea.

Palmyra Garage Sweeps

75004945	75004945	18"	12/cs.
750049461	75004946	24"	1/ea.
75004946	75004946	24"	12/cs.
75004947	75004947	36"	1/ea.

Polypropylene - Wide Band

750049341	75004934	24"	1/ea.
75004934	75004934	24"	12/cs.
75004935	75004935	36"	1/ea.

Tampico

750049401	75004940	18"	1/ea.
75004940	75004940	18"	12/cs.
750049411	75004941	24"	1/ea.
75004941	75004941	24"	12/cs.
75004942	75004942	36"	1/ea.
750049421	75004942	36"	4/cs.



B. PRIME SOURCE® PUSH BROOMS PRIME SOURCE®

Heavy polypropylene center and flagged polypropylene around the outside perimeter to pick up both fine and medium particles. Wood blocks. Black center fibers with gray casing fibers.

75004926	75004926	24"	12/cs.
75004927	75004927	36"	1/ea.

These split-tipped, synthetic fiber sweeps are excellent for picking up fine particles of dust and dirt on smooth floor surfaces. Wood blocks. Gray fibers, 3" trim.

750049211	75004921	24"	1/ea.
75004921	75004921	24"	12/cs.
75004922	75004922	36"	1/ea.



C. OMNI SWEEP® FLOOR SWEEP CARLISLE

Combines the features of fine, medium, and heavy floor sweeps into one convenient floor sweep. Patent-pending design and chemical-resistant bristles remove everything from heavy debris to the finest particles on any type of floor surface. Synthetic bristles have an angled pitch for fast, effective sweeping on all types of floor surfaces. Short, heavy bristles in front easily sweep up heavy debris. Long, fine/medium bristles in back sweep fine dust and particles; can be used with sweeping compounds. Hygienic plastic block has threaded handle hole to accommodate all types of threaded handles; can be integrated into a HACCP compliant program by utilizing the Sparta® Spectrum® Self-Locking Flex-Tip® Fiberglass Handle (40225), sold separately.

63878000	41880	18"	12/cs.
63878001	41881	24"	12/cs.



BROOM BRACES

D. PRIME SOURCE® BROOM BRACES PRIME SOURCE®

Rust-resistant braces providing extra support for sweeps.

750098581	75009858	Small	1/ea.
750098591	75009859	Large	1/ea.
75009859	75009859	Large	12/cs.

E. PRIME SOURCE® HANDLE ARM BRACE PRIME SOURCE®

Arm brace that provides extra support.

75004959	75004959	For Wide Sweeps	12/cs.
----------	----------	-----------------	--------



CLEANING TOOLS

Broom Handles



BROOM HANDLES

A. PRIME SOURCE® THREADED FIBERGLASS HANDLE PRIME SOURCE®

Great for use with wet mops, sweeps and brushes.

750098531	75009853	60" x 1", Flex Tip	1/ea.
75009853	75009853	60" x 1", Flex Tip	12/cs.



B. PRIME SOURCE® LUMATHREAD HANDLES PRIME SOURCE®

Threaded broom handles.

750098511	75009851	60" x 15/16"	1/ea.
75009851	75009851	60" x 15/16"	12/cs.
750098521	75009852	60" x 1 1/8"	1/ea.



C. PRIME SOURCE® METAL TIP THREADED HANDLES PRIME SOURCE®

Great for use with sweeps and scrub brushes.

750049511	75004951	60" x 15/16"	1/ea.
75004951	75004951	60" x 15/16"	12/cs.
75004952	75004952	60" x 1 1/8"	12/cs.
75004953	75004953	60" x 1"	12/cs.

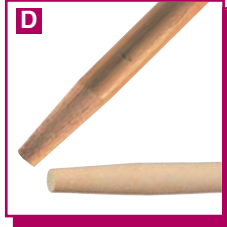

D. PRIME SOURCE® TAPERED WOOD HANDLES PRIME SOURCE®

Tapered wood handles.

750049581	75004958	60"	1/ea.
750049541	75004954	60" x 1 1/8"	1/ea.
75004954	75004954	60" x 1 1/8"	12/cs.

Constructed from natural hardwood, this durable handle is great for quick and easy changes.

750098541	75009854	60" x 1 1/8"	1/ea.
75009854	75009854	60" x 1 1/8"	12/cs.



E. PRIME SOURCE® THREADED WOOD HANDLES PRIME SOURCE®

Threaded wood handles.

750098501	75009850	60" x 15/16"	1/ea.
750049501	75004950	60" x 15/16"	1/ea.
75004950	75004950	60" x 15/16"	12/cs.



F. METAL-TIP THREADED HANDLE CARLISLE

Natural lacquered hardwood handle with metal thread tip.

63870148	45267	60" x 15/16"	12/cs.
----------	-------	--------------	--------



G. TAPERED WOOD HANDLES CARLISLE

Lacquered hardwood with precision cut tapered end for consistent dependability.

63870263	40261	54" x 1 1/8"	12/cs.
638706411	40262	60" x 1 1/8"	1/ea.



H. TAPERED WOOD HANDLE CCP

Constructed from natural hardwood, this durable handle is available in many different sizes. Tapered end is great for quick and easy changes.

276090601	M109060	1 1/8" x 60"	1/ea.
27609060	M109060	1 1/8" x 60"	12/cs.



I. THREADED WOOD HANDLE RUBBERMAID

Lacquered wood handle with threaded metal tip. For floor sweeps.

177063641	6364LAC	60" x 15/16"	1/ea.
-----------	---------	--------------	-------

Dust Pans/Dusting Tools



DUST PANS

A. DUST PANS

CCP

Metal

Heavy-duty metal dust pan with thin sweep edge to eliminate repeated sweeping.

276007151	715	12"W, Black	1/ea.
27600725	715	12"W, Black	12/cs.

Extra Wide Metal

Extra wide metal dust pan with thin sweep edge to eliminate repeated sweeping.

276071601	716	16"W, Black	1/ea.
------------------	-----	-------------	-------

Plastic

Constructed of tough, yet flexible black plastic with thin front edge for maximum dirt pick up.

276008301	712	12"W, Black	1/ea.
27600830	712	12"W, Black	12/cs.



B. LOBBY DUST PANS

CCP

Metal

Metal dust pan, with powder coated finish. Chrome handle with hanger.

276007311	825	12" x 9" x 30 1/2", Black	1/ea.
------------------	-----	---------------------------	-------

Plastic

Plastic hopper with strong metal handle. Pan snap-locks in use and releases to dump or carry. Space saving hanger for storage. The true-edge of pan conforms to floor to eliminate need for repeated sweeping.

276009121	912	10 3/4" x 12" x 36 3/4", Black	1/ea.
27600912	912	10 3/4" x 12" x 36 3/4", Black	6/cs.



C. HEAVY-DUTY DUST PAN

RUBBERMAID

Heavy-duty plastic construction. Thin front edge for easy dirt pick-up.

177020051	2005	8 1/4"W x 12 1/4"L x 2 5/8"D, Charcoal	1/ea.
17702005	2005	8 1/4"W x 12 1/4"L x 2 5/8"D, Charcoal	12/cs.



D. LOBBY PRO® UPRIGHT DUST PAN

RUBBERMAID

Stylish pan design. Durable rear wheels for improved wear resistance.

177041491	2531BLA	11 3/10" x 12 4/5" x 5" Pan, Black	1/ea.
17704149	2531BLA	11 3/10" x 12 4/5" x 5" Pan, Black	6/cs.



DUSTING TOOLS

E. CHIX® MASSLINN® DUST CLOTH

CHICOPEE

Heavy-duty, stretch activated dusting cloth with mineral oil treatment. Safe to use on all floor surfaces. Does not leave residue or lint behind. Contains Microban®.

25600911	0911	50 ct., 24" x 24", Yellow	100/cs.
-----------------	------	---------------------------	---------



F. CHIX® STRETCH 'N DUST® CLEANING CLOTH

CHICOPEE

Treated cloth becomes a dust magnet and traps dust when stretched. Leaves surfaces dust-free without the trouble and cost of sprays. Picks up more dust in one pass than conventional cloths with sprays. Eliminates waxy buildup. Contains Microban®.

25600416	0416	20 ct., 23 3/4" x 24", Yellow/Orange	100/cs.
-----------------	------	--------------------------------------	---------



G. PLEDGE® GRAB-IT™ DRY REFILL CLOTHS

DIVERSEY

Cloths contain no sprays or polish and can be used alone or with the Pledge® Grab-It™ Sweeper. When you're done, simply throw the cloths away. Safe for use on wood, ceramic, vinyl and many other hard surfaces. Does not contain sprays or polish so they won't leave a residue. Do not launder. Do not dispose of in toilets.

15203281	CB663281	32 ct.	6/cs.
-----------------	----------	--------	-------



Dusting Tools/Microfiber Cleaning



A. SWIFFER® 306° DUSTER **PROCTER & GAMBLE**
 The Swiffer® 360° Duster has thousands of deep-cleaning fibers that help reduce allergens. Designed specifically to clean dirt in grooves and crevices, it traps and locks dust and allergens better than a feather duster. The clever all-around design features 50% more fibers than regular Swiffer® dusters, allowing it to lock dust away for a thorough clean.
16900112 3700016942 Starter Kit, (1 Handle & 1 Disposable Duster) 12/cs.
16900113 3700016944 Refills, Unscented, 6 ct. 6/cs.



B. SWIFFER® DUSTERS **PROCTER & GAMBLE**
 Soft and fluffy disposable dusters with fibers that grab dirt and lock it away. You'll be surprised to discover how easy it is to dust both small places and large areas. When you're finished cleaning, just toss the duster and the dust into the garbage.
16904623 40509 Duster w/Short Handle, 5 ct. 45/cs.
16904750 44750 Duster w/Extendable Handle, Up to 3', 5 ct. 12/cs.
16901767 41767 Refills, 10 ct. 60/cs.



C. SWIFFER MAX® DUSTING SYSTEM **PROCTER & GAMBLE**
 Swiffer Max® is bigger for faster and easier cleaning. Its new textured head picks up even more particles and the thick cloths still use electrostatic action and deep Lift and Lock Pockets™ to attract and trap household soils. Safe for wood, ceramic, vinyl, laminate floors, and electronics.
16907108 37108 Sweeper Tool Only, 17"W 3/cs.
16907109 37109 Refills Only, 16 Cloths, 17"W 6/cs.



D. SWIFFER® SWEEPER **PROCTER & GAMBLE**
 Gets into the tough spots easily, avoiding bending or ladder use. Dry, disposable cloths can be attached to the sweeper or used alone for hand dusting. Wet cloths remove dust and are safe for wood, ceramic, vinyl, tile, electronics and other hard surfaces. They leave no residue.
16909061 09060 Implement Only, 10"W 3/cs.
16905154 35154 Swiffer® Wet Refills, 12 ct. 12/cs.
16904240 24240 Swiffer® Dry Refills, 32 ct. 192/cs.



E. OVERHEAD DUSTING TOOLS **RUBBERMAID**
 The sensible solution to routine overhead dusting. Launderable head for long product life. Telescoping handle for simple and efficient overhead use.
17701200 T120 51" Extension Handle, Angled Head 12/cs.
17701300 T130 102" Extension Handle 12/cs.



MICROFIBER CLEANING



F. PRIME SOURCE® CLASSIC MICROFIBER CLOTH **PRIME SOURCE®**
 For streak-free cleaning of glass and polished metal surfaces.
75004929 75004929 12" x 12", Blue 12/pk.

G. PRIME SOURCE® SUPREMO™ MICROFIBER CLOTH **PRIME SOURCE®**
 Can be used dry for dusting or damp for removing tough dirt and grime. Textured surface captures dust and dirt using less water, chemicals and effort.
75004938 75004938 12" x 12", Blue 12/cs.

Microfiber Cleaning



A. PRIME SOURCE® PRO™ FLAT MOP FRAME PRIME SOURCE®

For use with Pro™ flat mop handles and Super Pro™ microfiber mops.

75004968 75004968 3" x 18" 6/cs.



B. PRIME SOURCE® PRO™ FLAT MOP HANDLE PRIME SOURCE®

For use with Pro™ flat mop handles and Super Pro™ microfiber mops.

75004949 75004949 33" to 60", Telescopic 6/cs.



C. PRIME SOURCE® SUPER PRO™ MICROFIBER MOPS PRIME SOURCE®

For use with Pro™ flat mop handles and frames. Constructed of 3 micron fiber. Remove, absorb, and accumulate virtually any type of dust, dirt, grease, or contaminant.

75004962 75004962 5" x 12", Blue 10/cs.
 75004963 75004963 5" x 20", Blue 10/cs.
 75004966 75004966 5" x 20", Red 10/cs.
 75004964 75004964 5" x 26", Blue 10/cs.



D. THE AGGRESSOR™ MICROFIBER SCRUBBING REFILL CCP

Innovative combination of microfiber yarn and synthetic stiff brush fibers. Designed to remove debris stuck to the floor that normal "yarn only" microfiber flat mops cannot.

276001261 C109020 5" x 20", Blue/White 1/ea.
 27600126 C109020 5" x 20", Blue/White 10/cs.

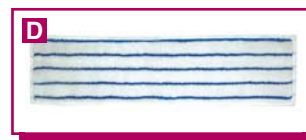

E. GLASSIC™ MICROFIBER CLOTHS CCP

Perfect for cleaning soap, grease or fingerprints from windows, mirrors and polished metal surfaces. Leaves a streak-free finish. Can be laundered five times more than cotton towels.

27600228 E222022 10" x 7" Mitt, Green 12/cs.
 27602222 E850016 16" x 16" Cloth, Light Blue 12/cs.



F. ERGOWORX™ TOUCHLESS MICROTEK CLEANING SYSTEM CCP

Designed to fit all of the most popular plastic and stainless steel janitorial carts made. ErgoWorx™ solution and discharge buckets are made from Derma-Tek™ non-porous plastic. Auto-discharge mop frame is made from glass-filled nylon. Completely non-ferrous; safe for use in areas with MRI equipment, will not rust or corrode. System includes: one solution bucket with perforated screen, one discharge bucket with aluminum discharge rod and one auto-discharge microfiber mop frame. 3" non-marking, all-swivel casters provide finger touch mobility, ideal for tight hallways and small rooms. MFT-5 designed to accommodate common cleaning tools including a wet floor sign, microflex duster, wipes and RTU trigger sprayer bottles.

27605050 SYS5 Complete System 1/ea.
 276012001 MF5BK Auto-Discharge Mop Frame, Black 1/ea.
 276050511 SB5YW Discharge Bucket w/Aluminum Discharge Rod 1/ea.
 27605052 MFT5BK Trolley, Black 1/ea.



G. SUPER PRO FINISH MOP MICROFIBER REFILL CCP

Microfiber finish flat mop is looped end and constructed of high-wet modulus rayon blend yarn that provides quick, controlled liquid release. The finish flat mop will cover a 20" wide swath. Unlike conventional finish mops, 100% of the floor finish goes onto the floor along with full contact of the refill to the surface allowing better productivity and less chemical wasted in the mop. Should be rinsed after every use.

27602980 C106020 5" x 20", Light Blue 6/cs.



H. MICROFLEX™ DUSTER CCP

Flexible, thin foam frame allows for effective cleaning in tight, hard-to-reach areas. Frame accepts a hand held handle or either one of our Pro™ flat mop handles for high area cleaning. Microfiber refill for durability and long product life. Simply rinse away dirt with water after every use. Duster refills available separately.

27606025 E224000 Complete Duster, 2" x 27" 1/ea.
 27602907 E224100 Refills, 2" x 22" 3/cs.



Microfiber Cleaning



A. PRO™ FLAT MOP HANDLE CCP

Made of lightweight, long-lasting aluminum that will not rust or corrode. Twist lock mechanism allows extendable handle to adjust from 39" to 60".

276071401	<i>C714000</i>	39" to 60"	1/ea.
27607140	<i>C714000</i>	39" to 60"	10/cs.



B. PRO II™ FLAT MOP FRAMES CCP

Lightweight design allows for dramatic improvements in labor productivity. Trapezoid head effectively cleans corners and edges. 360° swivel attachment for maneuvering in tight areas. Handle locking clip to secure handle to frame connector. Designed to complement our line of microfiber refills.

276071701	<i>C717018</i>	4 ³ / ₄ " x 18"	1/ea.
276071711	<i>C717024</i>	4 ³ / ₄ " x 26"	1/ea.
27607171	<i>C717024</i>	4 ³ / ₄ " x 26"	10/cs.



C. SUPER PRO II™ MICROFIBER REFILLS CCP

Looped-end construction and durable Microfiber provide long product life. Made of 100% Microfiber, it can be laundered 300 to 500 times, when cared for properly. Perma-Stitch sewn border is extremely durable. Hook and loop attachment for easy installation and removal from frame. Can be used for damp or dry mopping.

27602991	<i>C103020</i>	5" x 20", Blue	10/cs.
27602998	<i>C108020</i>	5" x 20", Green	10/cs.
27602996	<i>C104020</i>	5" x 20", Red	10/cs.
27602995	<i>C107020</i>	5" x 20", Yellow	10/cs.
27602992	<i>C103026</i>	5" x 26", Blue	10/cs.
27602997	<i>C104026</i>	5" x 26", Red	10/cs.



D. SUPREMO™ MICROFIBER CLOTHS CCP

Highest quality microfiber available. A 45-50 gram all purpose cleaning cloths that contain 70% polyester and 30% polyamide. Great for dusting and cleaning all types of surfaces.

27602210	<i>E221000</i>	12" x 12", Blue	12/cs.
27602211	<i>E800016</i>	16" x 16", Green	12/cs.
27606200	<i>E810016</i>	16" x 16", Blue	12/cs.
27606202	<i>E840016</i>	16" x 16", Pink	12/cs.
27606203	<i>E830016</i>	16" x 16", Yellow	12/cs.



E. PACE™ FLOOR CLEANING SYSTEM DIVERSEY

This high-efficiency cleaning tool is extremely light and maneuverable for damp mopping and wet mopping. Use on hard surface areas. Ideal when on-site laundry facilities are not available.

15205354	<i>3345354</i>	Cleaning Tool, Includes Solution Bottle	1/ea.
15205274	<i>3345274</i>	Disposable Pad	250/cs.



F. WYPALL® MICROFIBER CLOTHS KIMBERLY-CLARK

Microfiber cloths with Microban® protection are durable, remarkably absorbent, and environmentally friendly. No chemicals needed. Cleans virtually any surface; wet, dry, or damp. Absorbs eight times its weight in liquid. Can be laundered 300 times. Color-coding helps reduce cross-contamination.

15403620	<i>83620</i>	15 ³ / ₄ " x 15 ³ / ₄ ", Blue	24/cs.
15403630	<i>83630</i>	15 ³ / ₄ " x 15 ³ / ₄ ", Green	24/cs.
15403980	<i>83980</i>	15 ³ / ₄ " x 15 ³ / ₄ ", Red	24/cs.
15403610	<i>83610</i>	15 ³ / ₄ " x 15 ³ / ₄ ", Yellow	24/cs.

Microfiber Cleaning



A. HYGEN™ CHARGING BUCKET RUBBERMAID

Designed especially for healthcare cleaning. Holds up to (20) microfiber wet pads, generally enough for one housekeeper for one shift using one pad per room. Molded-in filling guide; 1 qt. per 5 pads. Smooth, non-porous surface helps prevent bacterial growth and cleans up easily. Buckets fit onto the #6173 janitor cart and accommodate pads up to 18" in length.
177050901 Q95088 Yellow 1/ea.



B. HYGEN™ CLEAN WATER SYSTEM FILTER BUCKET W/WRINGER COMBO RUBBERMAID

One bucket fill provides clean water all day eliminating unproductive trips to the janitor closet. Twin roller design provides optimized wringing efficiency. Built-in scrubbers remove dirt from the mop. Adjustable moisture level allows users to select desired mop dampness for better cleaning results. Floor drain allows users to empty bucket without lifting, reducing body strain. Back flushable filter easy to maintain. Compatible with all RCP janitor carts.
17701797 1791797 36"L x 24"W x 21"H 1/ea.



C. HYGEN™ HANDLE RUBBERMAID

Lightweight aluminum construction. One-step connecting mechanism speeds mop assembly and changeover. User-friendly grip makes handle more comfortable to use.
177007501 Q750 58" 1/ea.



D. HYGEN™ QUICK-CONNECT WET/DRY FRAME RUBBERMAID

Flat profile slides easily under furniture and equipment. Lightweight aluminum construction for improved productivity. One-step connecting mechanism speeds mop assembly and changeover. Flat frame profile is sanitary and easy to clean. Replaceable hook-and-loop strips' cost efficiently extend product life.
177055601 Q560YL00 3 1/2"W x 18"L x 1 1/2"H, Yellow 1/ea.



E. HYGEN™ MICROFIBER CLEANING CLOTHS RUBBERMAID

Dense "ultra-fine" quality fiber removes more dust, dirt and bacteria than conventional cleaning products. Double finished edges retain pad shape with use over time. Color coded products help reduce cross contamination by differentiating area of use.
17704120 Q61000YL00 16" x 16", Bathroom Cloth, Yellow 12/cs.
17704125 Q630 16" x 16", Glass/Mirror Cloth, Blue 12/cs.

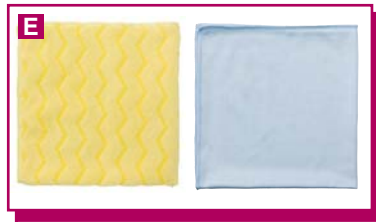

F. HYGEN™ MICROFIBER CLEANING PAD RUBBERMAID

Dense 3-5 micrometer quality fiber removes more dust, dirt and microbes than conventional cleaning products. Advanced hook-and-loop backing holds up under harsh laundering conditions and attaches pads more securely.
177041001 Q410BL00 18 1/2"L x 5 1/2"W, Wet Room Pad, Blue 1/ea.



G. MICROFIBER FINISH PAD RUBBERMAID

Dense quality fiber removes more dust, dirt and microbes than conventional cleaning products. Foam liner controls liquid content and release. Advanced hook and loop backing holds-up under harsh laundering conditions and attaches pads more securely.
177008921 Q800 18" 1/ea.



H. MICROFIBER FINISH BUCKET RUBBERMAID

Perfect for tamping excess finish from microfiber flat mops. Washboard surface effectively removes dirt and debris from mop pads before wringing. Twist-valve empties contents without lifting. Smooth, non-porous surface helps prevent bacterial growth and cleans up easily. Buckets fit onto the #6173 janitor cart and accommodate pads up to 18" in length.
17701930 Q930 Blue 1/ea.



I. RUBBERMAID PULSE™ MICROFIBER FLOOR CLEANING SYSTEM RUBBERMAID

Microfiber floor cleaning system. Red ergonomic trigger handle dispenses three streams of cleaning solution with each press. Lightweight construction, weighs only four pounds when fully loaded with solution. High-capacity refillable reservoir holds 21 ounces of solution to clean up to 850 square feet of floor space. Reservoir windows allow easy monitoring of fluid level. 18" Quick-Connect frame included. Also works with Rubbermaid 11" and 24" Quick-Connect frames and pads.
17700121 Q969 56"L x 4 7/8"W x 3 3/4"H, 21 oz., Yellow 1/ea.



CLEANING TOOLS

Dust Mops

DUST MOPS



A. PRIME SOURCE® DISPOSABLE DUST MOP PRIME SOURCE®

Cotton/synthetic yarn with polyester backing for performance, durability and value. Split center provides a trap to collect dust and dirt. Use with Swivel Snap™ frame and handle.
750046381 75004638 36" x 5", Natural 1/ea.

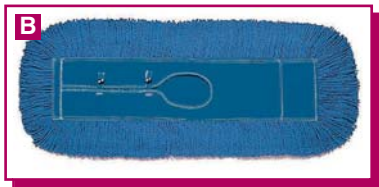

B. PRIME SOURCE® PERMATWIST™ DUST MOPS PRIME SOURCE®

Exclusive bonding process of 100% ring-spun cotton yarn virtually eliminates fraying and linting. Brilliant, permanent colors keep this duster looking new. PermaTwist delivers unsurpassed durability and performance.
75004760 75004760 18" x 5", Blue 12/cs.
750047611 75004761 24" x 5", Blue 1/ea.
75004761 75004761 24" x 5", Blue 12/cs.
750047621 75004762 36" x 5", Blue 1/ea.
75004762 75004762 36" x 5", Blue 12/cs.
75004630 75004630 36" x 5", Green 12/cs.
75004763 75004763 48" x 5", Blue 12/cs.
75004632 75004632 48" x 5", Green 6/cs.
75004764 75004764 60" x 5", Blue 12/cs.



C. PRIME SOURCE® SWIVEL SNAP™ DUST MOPS PRIME SOURCE®

Industry standard dust mop is constructed of four-ply cotton blended yarn with a durable synthetic backing. Absorbent yarn provides excellent dust retention.
75004765 75004765 18" x 5", Natural 12/cs.
750047661 75004766 24" x 5", Natural 1/ea.
75004766 75004766 24" x 5", Natural 12/cs.
75004767 75004767 36" x 5", Natural 12/cs.
75004769 75004769 60" x 5", Natural 12/cs.



D. PRIME SOURCE® TRIANGLE DUST MOP PRIME SOURCE®

These small dusters lie flat in tight areas like offices, and classrooms. Removable mop head is launderable and is made from standard cotton blend yarn.
75004775 75004775 12" x 17", Natural 12/cs.



E. PRIME SOURCE® TYPAR™ DISPOSABLE DUST MOPS PRIME SOURCE®

Cotton/synthetic yarn with TYPAR™ backing. Bulky, absorbent, pre-treated yarn collects and retains more dust and will cover over a million square feet before replacement is needed. Split center provides a trap to collect even more dust.
750047701 75004770 18" x 5", Natural 1/ea.
75004770 75004770 18" x 5", Natural 12/cs.
750047711 75004771 24" x 5", Natural 1/ea.
75004771 75004771 24" x 5", Natural 12/cs.
750047721 75004772 36" x 5", Natural 1/ea.
75004772 75004772 36" x 5", Natural 12/cs.
75004773 75004773 48" x 5", Natural 12/cs.



F. SWIVEL SNAP™ DUST MOP CCP

Industry standard dust mop is constructed of four-ply cotton blended yarn with a durable synthetic backing. Absorbent yarn provides excellent dust retention.
276070361 C057036 36" x 5", Natural 1/ea.



G. BLENDED CUT-END DISPOSABLE DUST MOPS RUBBERMAID

Soft, open-twist blended cut-end yarn for increased dust pick-up. Pre-treated and good for 500,000 square feet of dust mopping before replacement. Full-tie backing style.
177009071 L153WH00 5" x 24", White 1/ea.
177036101 L155WH00 5" x 36", White 1/ea.

Dust Mops/Dust Mop Frames



A. DISPOSABLE COTTON DUST MOPS RUBBERMAID

Economical cotton cut-end dust mops. Pretreated for your convenience. Full-tie backing.
17700253 L253 5" x 24", White 12/cs.
17703255 L255 5" x 36", White 12/cs.



B. KUT-A-WAY® DUST MOP RUBBERMAID

Cut-end mop excellent for general purpose dust mopping. Pre-laundered and pre-shrunk. Launderable for long product life. Envelope backing style.
177009251 K155WH00 36" x 5", White 1/ea.



C. TRAPPER® DUST MOPS RUBBERMAID

Looped-end, balanced blend dust mop for general purpose dust mopping. Pre-treated, pre-shrunk and fully launderable for long product life. Envelope backing style.
17700087 J153 5" x 24", Yellow 12/cs.
177003271 J155 5" x 36", Yellow 1/ea.



D. DURA-TWIST™ DUST MOP ZEPHYR

A top quality industrial mop designed and built to withstand multiple washing cycles while retaining the ability to pick up and hold a maximum amount of dust. Stays put on the frame because of its sturdy, snug side-load construction and positive snap closure. Constructed out of blended synthetic yarn with a permanent set that resists unraveling.
75080079 13724 24" x 5", Blue 6/cs.



E. UTILITY+™ INDUSTRIAL TIE-ON DUST MOP ZEPHYR

Built on high quality sanforized cotton duck canvas with four-ply cotton yarn available. Sewn on with double stitching to ensure rugged performance. Complete with nylon ties for easy mop head replacement on most any type frame.
75082780 13424 24" x 5", Natural 6/cs.



DUST MOP FRAMES

F. SWIVEL SNAP™ DUST MOP FRAMES PRIME SOURCE®

Constructed of durable, rust-resistant black powder coated metal wire.
75004778 75004778 12" x 5" 12/cs.
75004779 75004779 18" x 5" 12/cs.
750047791 75004779 18" x 5" 1/ea.
750047801 75004780 24" x 5" 1/ea.
75004780 75004780 24" x 5" 12/cs.
750047811 75004781 36" x 5" 1/ea.
75004781 75004781 36" x 5" 12/cs.
750047821 75004782 48" x 5" 1/ea.
75004782 75004782 48" x 5" 12/cs.
750047831 75004783 60" x 5" 1/ea.
75004783 75004783 60" x 5" 12/cs.
75004784 75004784 72" x 5" 12/cs.



G. SNAP-ON WIRE DUST MOP FRAME RUBBERMAID

Corrosion-resistant, powder coated, heavy-duty metal frame for durable performance.
177024301 M253 24" x 5" 1/ea.

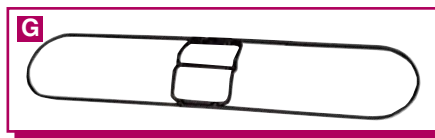

H. BBL™ DUST MOP FRAME ZEPHYR

Clip-on style dust mop frame. For situations when price is the main concern, we offer our BBL™ (Brown Box Line).
75080245 09053 24" x 5" 12/cs.

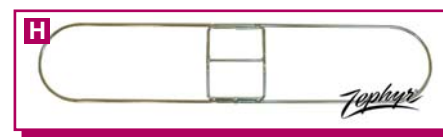

Dust Mop Handles/Wall Washer/Looped-End Mops



CLEANING TOOLS



A. SWIVEL SNAP™ DUST MOP HANDLE PRIME SOURCE®

Wood handle featuring 180° swivel action or rigid position and spring clip for easy attachment to frame.

750047851	75004785	60"L	1/ea.
75004785	75004785	60"L	12/cs.



B. SNAP-ON DUST MOP HANDLE RUBBERMAID

Attach to the snap-on dust mop frame. Sliding collar locks the handle into position or allows for a full 360° swivel action. Hardwood handle.

177091161	M116	60"L	1/ea.
-----------	------	------	-------



C. CLIP-ON DUST MOP HANDLE ZEPHYR

The clip-on connector fits almost any standard frame and can be locked rigid or unlocked for full swivel action.

75080250	09063	60"L	12/cs.
----------	-------	------	--------



WALL WASHER

D. WALL WASHER KIT RUBBERMAID

Kit includes one aluminum handle, one plastic head and two cotton pads. Features a pivoting head for smooth, even control. Raised-ribbed design works with either side pressure or downward pressure mop wringers without requiring additional adapters. Washable pads remove easily for convenient laundering.

17701226	S226	60"L	1/ea.
----------	------	------	-------



LOOPED-END MOPS

E. PRIME SOURCE® BLENDED LOOPED-END MOPS PRIME SOURCE®

Bulldog™

The economical choice. This is the perfect mop to choose to upgrade from a cut-end mop to a looped-end mop and is ideal for general purpose cleaning. Four-ply cotton/synthetic blend. 5" headbands.

75004667	75004667	Small, Natural	12/cs.
75004674	75004674	Medium, Blue	12/cs.
750046681	75004668	Medium, Natural	1/ea.
75004668	75004668	Medium, Natural	12/cs.
750046691	75004669	Large, Natural	1/ea.
75004669	75004669	Large, Natural	12/cs.

Hospital Pro M™

Designed for the demanding needs of the health care industry, the Hospital Pro M™ stands up to tough use and heavy washing. Its integrated blend of cotton/rayon/synthetic fibers insures durability and absorbency. Also ideal for all-purpose cleaning. 5" headbands.

75004723	75004723	Small, Blue	12/cs.
75004720	75004720	Small, White	12/cs.
750047241	75004724	Medium, Blue	1/ea.
75004721	75004721	Medium, White	12/cs.
750047251	75004725	Large, Blue	1/ea.
75004725	75004725	Large, Blue	12/cs.
75004722	75004722	Large, White	12/cs.

Looped-End Mops



A. PRIME SOURCE® BLENDED LOOPED-END MOPS (CONT.)

PRIME SOURCE®

J.W Atomic Loop™

This economical cotton/rayon/synthetic blend mop cleans two to three times the area with up to six times the life of a conventional cut-end mop.

750047341	75004734	Small, 5" Headband, Blue	1/ea.
75004734	75004734	Small, 5" Headband, Blue	12/cs.
750047381	75004738	Medium, 1 1/4" Headband, Blue/White	1/ea.
75004738	75004738	Medium, 1 1/4" Headband, Blue/White	12/cs.
75004735	75004735	Medium, 5" Headband, Blue	12/cs.
750047561	75004756	Medium, 5" Headband, Green	1/ea.
75004756	75004756	Medium, 5" Headband, Green	12/cs.
75004731	75004731	Medium, 5" Headband, Natural	12/cs.
750047311	75004731	Medium, 5" Headband, Natural	1/ea.
75004739	75004739	Large, 1 1/4" Headband, Blue/White	12/cs.
750047361	75004736	Large, 5" Headband, Blue	1/ea.
75004736	75004736	Large, 5" Headband, Blue	12/cs.
75004732	75004732	Large, 5" Headband, Natural	12/cs.
75004737	75004737	X-Large, 5" Headband, Blue	12/cs.
75004733	75004733	X-Large, 5" Headband, Natural	12/cs.

Rough Rider™

Very absorbent strands make this mop great for foodservice and other general maintenance uses. Stands up to any floor surface including stone and concrete. 5" mesh headbands.

75004728	75004728	Medium, White	12/cs.
75004729	75004729	Large, White	12/cs.



B. BULLDOG™ LOOPED-END MOP

CCP

A cotton mop that is the perfect choice to upgrade from a cut-end mop to a looped-end mop and is ideal for general purpose cleaning. 5" headband.

276006891	A04903	Large	1/ea.
------------------	--------	-------	-------



C. LOOPED-END MOPS

RUBBERMAID

Super Stitch®

Outperforms and outlasts premium cut-end mops. Balanced blend of cotton and synthetic yarns for absorbency and strength. Looped-ends and yarn tailband mop for greater floor coverage. 5" headband.

17702306	D25306BL00	Large, Blue	6/cs.
-----------------	------------	-------------	-------

Swinger Loop®

Looped-end, tailbanded mop for greater floor coverage. Four-ply, balanced blend of cotton and synthetic yarn for absorbency and strength. Launderable for long product life. 5" headband.

17700466	C15306WH00	Large, White	6/cs.
-----------------	------------	--------------	-------

Web Foot®

Contains Microban® antimicrobial product protection, which inhibits the growth of bacteria that cause odors and stains. Balanced blend of cotton and synthetic fibers delivers up to five times the absorbency of cotton mops. Looped-end, open-twist yarn reduces linting. Tailband allows the mop to cover more floor area per stroke, saving time and money.

17701163	A11206WH00	Medium, 1" Headband, White	6/cs.
17700468	A15206WH00	Medium, 5" Headband, White	6/cs.
17700918	A11306WH00	Large, 1" Headband, White	6/cs.
17700469	A15306WH00	Large, 5" Headband, White	6/cs.

Web Foot® Shrinkless®

The ultimate, launderable wet mop. Contains antimicrobial product protection, which inhibits the growth of bacteria that cause odors and stains. Four-ply, balanced blend of cotton and synthetic yarn withstands repeated launderings without shrinkage. Looped-ends and tailbanding reduce tangling for like-new performance after every laundering. Colorfast colors will not fade with repeated launderings. 5" headband.

17705209	A25206WH00	Medium, White	6/cs.
-----------------	------------	---------------	-------



Looped-End & Cut-End Mops



A. WEB FOOT® LOOPED-END MICROFIBER STRING MOP RUBBERMAID

Engineered with continuous filament bi-component Microfiber yarn for superior cleaning efficacy, superior absorbency and release characteristics. Twice the cleaning power versus a standard cotton mop. Double the durability of standard blend mops. Lasts 100+ launderings. Improved headband and tailband construction allows these advanced products to withstand two times the laundry cycles at 160°F wash temperatures and with the same detergents. Cleans 48% faster than a standard cotton mop. Environmentally friendly. Contains up to 28% post-consumer recycled PET plastic (soda bottles) and up to 21% post industrial cotton. Pre-laundered and pre-shrunk for increased performance after laundering. Compatible with standard wet mop tools. Does not require adapters or new flat-mopping handles or frames. 5" headband.

17705311 A85206GR Medium, Green 6/cs.



B. LOOPED-END MOPS ZEPHYR

Blendup™

Economical four-ply yarn is a blend of cotton, rayon, and polyester and has good initial absorbency.

75083129 28313 Large, Blue 12/cs.

75083030 28303 Large, Natural 12/cs.

Top-Kote™

Finish mop constructed using an advanced blended yarn with a blue stripe to insure proper usage. Built with a 1 1/4" mesh headband, looped construction, and tapeless fantail to maximize coverage and minimize problems.

75080061 27003 Large 12/cs.

Tuf/Blend™

A four-ply cotton, rayon and synthetic blend is used for the best combination of durability strength and absorbency. 5" headbands.

75082740 28212 Medium, Blue 12/cs.

75082750 28213 Large, Blue 12/cs.

Value+Plus™

Four-ply rayon mop head for waxing and applications that need less linting and more absorbency. 1 1/4" headband.

75086402 26402 Medium 12/cs.

CUT-END MOPS

C. PRIME SOURCE® CUT-END MOPS PRIME SOURCE®

Choice™ Cotton

Constructed of natural cotton fiber. Four-ply yarn gives the mop greater strength and durability. Traps dirt for quick clean-ups and all general purpose floor care.

750046511 75004651 16#, 1 1/4" Headband, White 1/ea.

75004651 75004651 16#, 1 1/4" Headband, White 12/cs.

75004661 75004661 16#, 5" Headband, White 12/cs.

750046617 750046617 16#, 5" Headband, White, Import 12/cs.

750046521 75004652 20#, 1 1/4" Headband, White 1/ea.

75004652 75004652 20#, 1 1/4" Headband, White 12/cs.

75004662 75004662 20#, 5" Headband, White 12/cs.

750046531 75004653 24#, 1 1/4" Headband, White 1/ea.

75004653 75004653 24#, 1 1/4" Headband, White 12/cs.

750046537 750046537 24#, 1 1/4" Headband, White, Import 12/cs.

750046631 75004663 24#, 5" Headband, White 1/ea.

75004663 75004663 24#, 5" Headband, White 12/cs.

750046637 750046637 24#, 5" Headband, White, Import 12/cs.

750046551 75004655 32#, 1 1/4" Headband, White 1/ea.

75004655 75004655 32#, 1 1/4" Headband, White 12/cs.

750046651 75004665 32#, 5" Headband, White 1/ea.

75004665 75004665 32#, 5" Headband, White 12/cs.

750046657 750046657 32#, 5" Headband, White, Import 12/cs.



Cut-End Mops



A. PRIME SOURCE® CUT-END MOPS (CONT.) PRIME SOURCE®

Choice™ Rayon

Constructed of four-ply synthetic fiber. Perfect for economy finishing and disinfecting. Rayon yarn soaks up spills instantly.

75004671	75004671	#16, 1 1/4" Headband, Natural	12/cs.
75004681	75004681	#16, 5" Headband, Natural	12/cs.
75004672	75004672	#20, 1 1/4" Headband, Natural	12/cs.
75004682	75004682	#20, 5" Headband, Natural	12/cs.
750046731	75004673	#24, 1 1/4" Headband, Natural	1/ea.
75004673	75004673	#24, 1 1/4" Headband, Natural	12/cs.
750046737	750046737	#24, 1 1/4" Headband, Natural, Import	12/cs.
750046831	75004683	#24, 5" Headband, Natural	1/ea.
75004683	75004683	#24, 5" Headband, Natural	12/cs.
75004675	75004675	#32, 1 1/4" Headband, Natural	12/cs.
75004685	75004685	#32, 5" Headband, Natural	12/cs.

Fan Mops

Regular width, labor saving fan mops feature four-sewn tailbands that keep yarn strands fanned out for greater surface coverage and less tangles. 1 1/4" headbands.

75004706	75004706	12 oz., Supreme	12/cs.
75004702	75004702	16 oz., Rayon	12/cs.
75004707	75004707	16 oz., Supreme	12/cs.
75004703	75004703	20 oz., Rayon	12/cs.
750047081	75004708	20 oz., Supreme	1/ea.
75004704	75004704	24 oz., Rayon	12/cs.
750047091	75004709	24 oz., Supreme	1/ea.
75004709	75004709	24 oz., Supreme	12/cs.
75004710	75004710	32 oz., Supreme	12/cs.

Go Go®

Low-cost, high quality cotton mops featuring colored yarn to keep mop looking new. With no break-in required, these absorbent, tough mops go to work right away. Ideal for use in public areas. 1 1/4" headbands.

75004648	75004648	#24, Blue	12/cs.
75004649	75004649	#32, Blue	12/cs.

Lie-Flat

Constructed of four-ply synthetic fiber. Perfect for economy finishing and disinfecting. Rayon yarn soaks up spills instantly.

75004797	75004797	#24	12/cs.
----------	----------	-----	--------

No Marr Pinnacle™

Pinnacle™ wet mops lie flat on the floor. Screw-on attachment makes mop head changes quick and easy. No Marr style eliminates marring of floors.

75004687	75004687	16 oz., Cotton, Natural	12/cs.
75004791	75004791	16 oz., Cotton, White	12/cs.
75004691	75004691	16 oz., Rayon, White	12/cs.
75004688	75004688	20 oz., Cotton, Natural	12/cs.
75004692	75004692	20 oz., Rayon, White	12/cs.
750046891	75004689	24 oz., Cotton, Natural	1/ea.
75004689	75004689	24 oz., Cotton, Natural	12/cs.
75004793	75004793	24 oz., Cotton, White	12/cs.
75004693	75004693	24 oz., Rayon, White	12/cs.
75004690	75004690	32 oz., Cotton, Natural	12/cs.
75004694	75004694	32 oz., Rayon, White	12/cs.

Stinger™

Four-ply mops for general purpose mopping. Natural cotton fibers.

750047161	75004716	16 oz., 1 1/4" Headband	1/ea.
75004716	75004716	16 oz., 1 1/4" Headband	12/cs.
750047171	75004717	20 oz., 1 1/4" Headband	1/ea.
75004717	75004717	20 oz., 1 1/4" Headband	12/cs.
750047181	75004718	24 oz., 1 1/4" Headband	1/ea.
75004718	75004718	24 oz., 1 1/4" Headband	12/cs.
75004713	75004713	24 oz., 5" Headband	12/cs.
750047191	75004719	32 oz., 1 1/4" Headband	1/ea.
75004719	75004719	32 oz., 1 1/4" Headband	12/cs.



CLEANING TOOLS

Cut-End Mops



A. PRIME SOURCE® CUT-END MOPS (CONT.) PRIME SOURCE®

Texray
Four-ply rayon yarn is great for liquid pick-up, economy finishing and disinfecting.

750047441	75004744	16 oz., 1 1/4" Headband	1/ea.
75004744	75004744	16 oz., 1 1/4" Headband	12/cs.
750047451	75004745	20 oz., 1 1/4" Headband	1/ea.
75004745	75004745	20 oz., 1 1/4" Headband	12/cs.
750047461	75004746	24 oz., 1 1/4" Headband	1/ea.
75004746	75004746	24 oz., 1 1/4" Headband	12/cs.
75004747	75004747	32 oz., 1 1/4" Headband	12/cs.
750047431	75004743	32 oz., 5" Headband	1/ea.

B. CUT-END MOPS CCP

Choice™
A low end cotton mop that is great for economical general cleaning and disinfecting. 1 1/4" headband.

27600129	A957124	#32, White	12/cs.
----------	---------	------------	--------

Rough Rider™
Cotton strands provide good absorption in this economical cut-end mop. Knitted material gives this mop much more strength than other cut-end mops. 1 1/4" headband.

27602213	A42213	Large	12/cs.
----------	--------	-------	--------

Stinger™
Four-ply natural cotton fibers for general purpose mopping. 1 1/4" headbands.

27604051	A401116	16 oz.	12/cs.
27604050	A401124	24 oz.	24/cs.

C. CUT-END MOPS RUBBERMAID

Dura-Pro®
Four-ply cotton/rayon/synthetic yarn blend for good performance and durability.

17700516	F516BL00	16 oz., 1" Headband, Blue	12/cs.
17700515	F516WH00	16 oz., 1" Headband, White	12/cs.
177065181	F518BL00	24 oz., 1" Headband, Blue	1/ea.
17700558	F558BL00	24 oz., 5" Headband, Blue	12/cs.
17706520	F519WH00	32 oz., 1" Headband, White	12/cs.

Premium
Four-ply cotton mop for general purpose cleaning. 1" headband.

177000721	F117	20 oz., White	1/ea.
-----------	------	---------------	-------

Value-Pro™
Economical, cotton mop for all purpose cleaning. 1" headband.

177011171	V117	20#, White	1/ea.
-----------	------	------------	-------

D. CUT-END MOPS ZEPHYR

BBL™
Cotton mops for situations when price is the main concern, we offer our BBL™ (Brown Box Line) mops. 1 1/4" plain poly headbands.

75089001	09001	#16	12/cs.
75089016	09003	#20	12/cs.
75089008	09005	#24	12/cs.
75089009	09007	#32	12/cs.

Economy
Come standard with a 1 1/4" wide headband and two rows stitching. General purpose mop head made from four-ply cotton.

75080116	58004	#24	12/cs.
75088005	58005	#32	12/cs.

Econo-Ray
Economy wet mop head with two rows stitching. Packed in plain poly bags. 1 1/4" headband.

75080212	58604	#24	12/cs.
----------	-------	-----	--------

Rayon
All purpose four-ply rayon for waxing and other applications that need less linting and more absorbency. 1 1/4" headband.

75080037	10524	24 oz.	12/cs.
----------	-------	--------	--------

Cut-End Mops/Deck/Yacht Mops/Mop Handles



A. CUT-END MOPS (CONT.)

ZEPHYR

Screwflat - Cotton

Economy general purpose four-ply cotton mop head.

75080226 57004 #24 12/cs.

Screwflat - Rayon

Four-ply rayon for waxing and other applications that need less linting and more absorbency. Lays flat on the floor for more efficient mopping. Screw-on handle eliminates handling of soiled head and provides for quick and easy changing of heads.

75080516 20516 16 oz. 12/cs.

75080051 20524 24 oz. 12/cs.

Shineup® Screwflat

Screwflat, four-ply cotton yarn that is excellent for general purpose cleaning.

75080065 20024 #24 12/cs.

Shineup®

A four-ply cotton mop head that is excellent for general purpose cleaning. 1 1/4" headband.

75080023 10016 #16 12/cs.

75080024 10020 #20 12/cs.

75080025 10024 #24 12/cs.

75080026 10032 #32 12/cs.

Sorbup™

The mop with super absorbency. 100% post-industrial recycled material. Uses less material than cotton. Limited linting. No break-in required. 4.3 times more absorbency and 2.3 times more release for over 20% less cost.

75080398 14053 Medium, White 12/cs.

Z-Ray™

An economical four-ply synthetic yarn that is good for general purpose use. 1 1/4" headband.

75080009 10624 24 oz. 12/cs.



DECK/YACHT MOP

B. PRIME SOURCE® DECK MOPS

PRIME SOURCE®

Cotton deck mops.

75004642 75004642 #32 6/cs.

75004643 75004643 #24 6/cs.

75004644 75004644 #26 6/cs.

C. PRIME SOURCE® YACHT MOPS

PRIME SOURCE®

Cord-tied yarn is securely attached to a wood handle. Ideal for infrequent users, such as small stores, offices and garages.

75004749 75004749 16 oz. 6/cs.

750047491 75004749 16 oz. 1/ea.

750047261 75004726 24 oz. 1/ea.

75004726 75004726 24 oz. 6/cs.

75004727 75004727 32 oz. 6/cs.



MOP HANDLES

D. PRIME SOURCE® PINNACLE™

WET MOP HANDLE

PRIME SOURCE®

Metal threaded connector is countersunk into wood handle. For use with Pinnacle style mops only.

750047001 75004700 60"L 1/ea.

75004700 75004700 60"L 12/cs.



E. PRIME SOURCE® QUICK CHANGE

STIRRUP MOP HANDLE

PRIME SOURCE®

Stirrup mop handle with a quick release bar (yoke). Recommended for narrow bands.

750046951 75004695 60"L 1/ea.

75004695 75004695 60"L 12/cs.



CLEANING TOOLS

Mop Handles/Sponge Mops



A. PRIME SOURCE® SPEED CHANGE™ MOP HANDLES PRIME SOURCE®

High-impact plastic head features a side release gate for fast and easy changes. Recommended for narrow bands.

750046991	75004699	60"L, Fiberglass Handle	1/ea.
75004699	75004699	60"L, Fiberglass Handle	12/cs.
750046971	75004697	60"L, Wood Handle	1/ea.
75004697	75004697	60"L, Wood Handle	12/cs.

B. PRIME SOURCE® SUPER JAWS™ MOP HANDLES PRIME SOURCE®

Extra durable nylon construction. Recommended for wide bands.

750046981	75004698	60"L, Fiberglass Handle	1/ea.
75004698	75004698	60"L, Fiberglass Handle	12/cs.
750046961	75004696	60"L, Wood Handle	1/ea.
75004696	75004696	60"L, Wood Handle	12/cs.

C. STIRRUP™ QUICK-CHANGE HANDLE CCP

Rugged handle featuring zinc-plated metal to resist rust and corrosion. Wingnut adjustment for easy mop head changes with two rivets to secure holder to handle. Quick release bar (yoke) to facilitate fast mop changes.

27600609	A70902	60"L, Wood Handle	12/cs.
----------	--------	-------------------	--------

D. GRIPPER® WET MOP HANDLES RUBBERMAID

Gripper® wet mop handles hold mops firmly between the jaws of the mop handle. Use 5" headband mops only. Plastic heads.

177003791	H245	54"L, Fiberglass Handle, Yellow	1/ea.
177002351	H235	54"L, Vinyl-Coated Aluminum Handle, Yellow	1/ea.
177002261	H226	60"L, Aluminum Handle, Yellow	1/ea.
17700727	H246GR00	60"L, Fiberglass Handle, Green	12/cs.
177008311	H216	60"L, Hardwood Handle, Yellow	1/ea.
17700236	H236	60"L, Vinyl-Coated Aluminum Handle, Yellow	12/cs.

E. INVADER® WET MOP HANDLE RUBBERMAID

A hinged side gate allows mops to easily slide on and off handle. A thumb wheel clamps the mop firmly in place. For use with 1" headband mops only. Plastic head.

177014601	H146GY00	60"L, Fiberglass Handle	12/cs.
-----------	----------	-------------------------	--------

F. STIRRUP™ WET MOP HANDLE RUBBERMAID

Antimicrobial handles containing Microban® B, which protects the product by inhibiting the growth of bacteria. Hinged side gate allows mop to easily slide on and off the handle. Thumb wheel clamps the mop firmly in place. Use with 1" headband.

177092261	H416	60"L x 1 1/8" dia.	1/ea.
-----------	------	--------------------	-------

SPONGE MOPS

G. PRIME SOURCE® HEAVY-DUTY ROLLER SPONGE MOP PRIME SOURCE®

This durable sponge mop features an extra wide cellulose sponge for maximum absorption and a convenient handle-mounted lever for efficient roller wringing. Wringing is easy without having to bend over. Plated metal construction and plastic rollers assure long service.

75004758	75004758	Complete Mop, 12"W	16/cs.
75004759	75004759	Sponge Refill, 12"W	16/cs.

H. COMBO SPONGE MOP CCP

Highly absorbent cellulose sponge mop is excellent for maintenance and sanitizer applications. Steel painted handle with hanger handle grip.

27601408	6012	Complete Mop, 12"W	12/cs.
27601411	6112	Sponge Refill, 12"W	2/cs.

Sponge Mops/Mop Wringers & Buckets



A. CLOROX® READMOP® STARTER KIT

CLOROX

The revolutionary Clorox® ReadyMop® mopping system brings together everything you need to clean your floors. This all-in-one mopping system with an onboard cleaner and absorbent cleaning pads delivers a convenient clean deeply and quickly. Gentle but persistent scrubbing pads attach to the easily maneuverable swivel head, so you can clean every nook and cranny. The Clorox® ReadyMop® Advanced Floor Cleaner is formulated to quickly dissolve dirt and grease. Just pull the trigger to dispense cleaning fluid that attacks dirt and dries fast. Absorbent Cleaning Pads are now scrubber and more effective than ever - yet gentle enough for wood floors.

38381285	14903	Complete w/Cleaner & 8 Pads, 24 oz.	4/cs.
38381287	14902	Cleaner Refill, 24 oz.	12/cs.
38384901	14901	Pad Refill, 8 Pads	96/cs.
38381286	14905	Pad Refill, 16 Pads	8/cs.



B. STEEL SPONGE MOP W/CELLULOSE HEAD

RUBBERMAID

An easy-to-use cleaning system. Synthetic sponge mop head. Handle mounted lever allows for squeeze-action wringing.

17700048	6435BRNZ	Complete Mop, 12", Bronze	6/cs.
17706436	6436YEL	Replacement Head, 12", Yellow	12/cs.



MOP WRINGERS

C. DOWN PRESS WRINGER

CCP

Accommodates a wide variety of mops. Ergonomic handle design for leverage and comfort.

27600996	SW7YW	16-32 oz. Mops, Yellow	1/ea.
-----------------	-------	------------------------	-------



D. SPLASH GUARD™ SIDE PRESS MOP WRINGER

CCP

Accommodates 12 to 32 oz. mops. Mop handle holder is molded into wringer front. Extended handle design for leverage and comfort. Wringer nests in bucket for economic storage and shipment. Fits Continental 26, 35, and 44 quart mop buckets.

276002251	SW12YW	12-32 oz. Mops, Yellow	1/ea.
------------------	--------	------------------------	-------



E. BRUTE® SIDE PRESS MOP WRINGER

RUBBERMAID

Torsion spring for up to 25,000 cycles for long product life. Corrosion-resistant handles and hardware.

17700527	612701YEL	12-32 oz. Mops, Yellow	1/ea.
-----------------	-----------	------------------------	-------



F. WAVEBRAKE® DOWN PRESS WRINGER

RUBBERMAID

High efficiency downward pressure mop wringer. Wrings mop with 18% less effort. Tested to 50,000 wringing cycles. Lasts 29 times longer than comparative wringers. Corrosion-resistant handle and hardware.

17702575	757588YEL	32 oz., Yellow	1/ea.
-----------------	-----------	----------------	-------



G. WAVEBRAKE® SIDE PRESS WRINGERS

RUBBERMAID

The WaveBrake® mop bucket and wringer system reduces splashing, which means a safer environment, cleaner floors, and improved productivity. High efficiency wringer for 28 and 35 qt. WaveBrake buckets. Lasts 58 times longer than comparative wringers. Tested to exceed 50,000 wringing cycles, average wringers perform approximately 860 cycles. Premium tubular steel and structural web molded plastic.

177061281	612788BRN	32 oz. Max Mop, Brown	1/ea.
177061271	612788YEL	32 oz. Max Mop, Yellow	1/ea.



MOP BUCKETS

H. SPLASH GUARD™ MOP BUCKETS

CCP

Feature 3" non-marking casters, embossed graduations and universal caution logo.

27602263	2263YW	26 qt., Yellow	1/ea.
27609192	3353YW	35 qt., Yellow	1/ea.



CLEANING TOOLS

Mop Buckets & Bucket/Wringer Combos



A. WAVEBRAKE® MOP BUCKETS RUBBERMAID

The WaveBrake® mop bucket reduces splashing, which means a safer environment, cleaner floors, and improved productivity.

177075661	757088BLUE	35 qt., Blue	1/ea.
17707578	757088BRN	35 qt., Brown	1/ea.
17707570	757088YEL	35 qt., Yellow	1/ea.



B. WAVEBRAKE® DIRTY WATER BUCKET RUBBERMAID

For 35 qt. WaveBrake® bucket (will not fit 26 qt.). Separates dirty water from clean water. Reduces risk of cross-contamination. Easy to empty.

177093081	9C74RED	18 qt., Red	1/ea.
-----------	---------	-------------	-------



C. BRUTE® REPLACEMENT CASTER RUBBERMAID

Replacement caster for 7570 and 7571 mop buckets.

17707751	7570L2	Plastic	1/ea.
----------	--------	---------	-------



BUCKET/WRINGER COMBOS

D. MOP BUCKET/WRINGER COMBO CCP

Mop bucket with 3" non-marking casters, embossed graduations, universal caution logo and SW7 down press wringer.

27604042	40437YW	44 qt., Yellow	1/ea.
----------	---------	----------------	-------



E. SMOOTHLINE™ MOP BUCKET/WRINGER COMBO CCP

Combo packs with a bucket and SW2 side press wringer. Non-marking 3" casters and universal caution symbol.

27606636	26636YW	26 qt., Yellow	1/ea.
----------	---------	----------------	-------



F. SPLASH GUARD™ MOP BUCKET/WRINGER COMBOS CCP

Down Press
Combo pack includes a bucket and SW7 down press wringer. International caution symbol. 3" non-marking casters.

27603353	33537YW	35 qt., Yellow	1/ea.
----------	---------	----------------	-------

Side Press
Combo pack with a bucket and SW12 side press wringer. Universal caution symbol. Non-marking 3" casters.

27602275	226312YW	26 qt., Yellow	1/ea.
27600229	335312YW	35 qt., Yellow	1/ea.



G. UNIBODY MOPPING SYSTEM CCP

One-piece design results in a positive transfer of force, removing more water per stroke. Includes self-draining and spigot and sediment screen drain grate.

27600221	351YW	35 qt., Yellow	1/ea.
----------	-------	----------------	-------



H. BUCKET/STRAINER COMBINATION RUBBERMAID

Lightweight combo pack lets operator travel up and down stairs easily. Bucket holds up to 15 qt. and strainer wrings up to a 10 oz. mop. Durable plastic construction has smooth, easy-to-clean surface. Pails and funnel-shaped mop strainers nest and stack for convenient transport and storage between jobs.

177061941	6194T	15 qt., 17" x 10½" x 12"	1/ea.
-----------	-------	--------------------------	-------

Bucket/Wringer Combos & Floor Finish Applicators



A. BUCKET/WRINGER COMBOS RUBBERMAID

Mopping combo packs with a 6118/88 mop bucket and 7575 down press wringer. Non-marking casters for reduced touch-up cleaning. Smooth, easy-to-clean surfaces.

17707574 7576BRN 44 qt., Brown 1/ea.
17707594 757688 44 qt., Yellow 1/ea.



B. EZMT™ BUCKET/WRINGER COMBO RUBBERMAID

Mopping combo pack with a 6185 mop bucket and 6127-01 wringer. Non-marking casters for reduced touch-up cleaning. EZMT™ foot activated emptying mechanism.

17706186 6186YEL Yellow 1/ea.



C. TANDEM™ BUCKET/WRINGER COMBO RUBBERMAID

All-in-one compact design means more effective wringing, better mop performance and no more lost parts. One-piece design: integrated bucket and wringer. Holes in both wringing plates force more water from mop in less time. Reverse-wringing mechanism for more comfortable use. Built-in lift handles on bottom of bucket make lifting and emptying easier.

17707380 7380 Up to 24 oz. Mops, Yellow 1/ea.



D. WAVEBRAKE® BUCKET/WRINGER COMBOS RUBBERMAID

Down Press

The WaveBrake® system reduces splashing, which means a safer environment, cleaner floors and improved productivity. High efficiency down press wringer. Tested to exceed 100,000 wringing cycles. Accepts optional dirty water bucket (9C74).

17707616 757788BRN 35 qt., Brown 1/ea.
17707615 757788YEL 35 qt., Yellow 1/ea.

Side Press

The WaveBrake® system reduces splashing, which means a safer environment, cleaner floors and improved productivity. High efficiency side press wringer. Lasts 58 times longer than comparative wringers. Premium tubular steel and structural web molded plastic.

177074801 748018YEL 26 qt., Yellow 1/ea.
17707602 758888BLUE 35 qt., Blue 1/ea.
17707600 758088BRN 35 qt., Brown 1/ea.
17707588 758888RED 35 qt., Red 1/ea.
17707586 758088YEL 35 qt., Yellow 1/ea.
177075869 758088YEL 35 qt., Yellow 12/cs.



E. WAVEBRAKE® DUAL WATER COMBO RUBBERMAID

The WaveBrake® mop bucket and wringer system reduces splashing. Down press wringer. Premium tubular steel and structural web molded plastic. Included dirty water bucket locks into place when in use, easily removable for emptying. Bucket in bucket system separates clean and dirty water. Quiet caster dolly makes half the noise of standard mop bucket.

17707677 7677YEL 35 qt., Yellow 1/ea.



FLOOR FINISH APPLICATORS

F. PRIME SOURCE® WAX APPLICATOR PRIME SOURCE®

Wax applicator, includes maple block, wool pad with natural back and 54" threaded wood handle. This professional tool is designed for smooth, lint-free application of floor finish, sealers and other liquid compounds. Quality 3/4" lambs wool is wrapped around a lacquered maple block and held in place by another block with wing nuts, providing easy pad replacement. Accommodates standard threaded handles. 100% synthetic.

75004752 75004752 Complete Applicator, 18"W 12/cs.

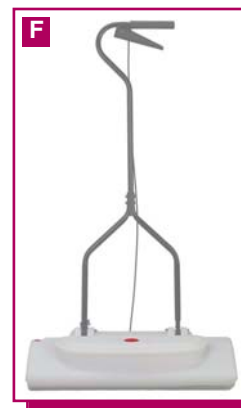

G. NYLON FINISH SYSTEM RUBBERMAID

Includes bucket with handle, lid, two sieves, four casters, six mop heads and frame. Helps ensure controlled absorption and release of finish. Delivers 200 to 300 sq. ft. of coverage with a single mop load of finish. Tightly-twisted rayon/synthetic blend looped-end mop absorbs and releases finish smoothly and evenly. Resealable bucket keeps finish fresh until next job, saving time and operating costs. Smooth, non-porous bucket cleans easily.

17700501 E050 Complete Kit, 22 qt. 1/ea.
17700520 E052 Mop Heads Only, 5" x 18", White/Blue Stripe 6/cs.



CLEANING TOOLS

Signage/Spill Station



SIGNAGE

A. WET FLOOR CONE CCP

Caution cone made of vinyl plastic with weighted tip-proof base. English only.
276010791 125ENG "Wet Floor", 18"H, Orange 1/ea.

B. WET FLOOR SIGN CCP

Easel type wet floor sign, printed on both sides in English/Spanish/German.
276007431 119 "Caution", 26"H, Yellow 1/ea.

C. WET FLOOR SIGN CCP

Easel type wet floor sign, printed on both sides in English/Spanish/German.
276007441 119C "Closed", 26"H, Yellow 1/ea.

D. FLOOR SIGNS RUBBERMAID

Imprinted in English, French and Spanish. Two-sided models for use in narrow areas. Folding design for convenient storage.
177061121 6112 "Caution", 25"H, Yellow 1/ea.
177003401 611277 "Caution Wet Floor", 25"H, Yellow 1/ea.
17700340 611277 "Caution Wet Floor", 25"H, Yellow 6/cs.
177003591 611278 "Closed", 25"H, Yellow 6/cs.

E. POP-UP SAFETY CONE RUBBERMAID

Collapsible, automatically deployed cone. Wall-mounted storage tube allows for easy and compact storing. Durable material withstands abuse. Multi-lingual message.
177062701 9S01 "Caution" Imprint/Wet Floor Symbol, 29"H, Yellow 1/ea.
17706270 9S01 "Caution" Imprint/Wet Floor Symbol, 29"H, Yellow 12/cs.

F. SAFETY CONES RUBBERMAID

Highly visible hazard protection system. Versatile top design accommodates barricade belt, flashing light and lock-in sign holder. Four-sided shape allows for efficient stacking. Molded-in slots for easy handling. Multi-lingual message.
17706280 6276 "Caution", 36"H, Yellow 5/cs.
177062761 627677 "Caution, Wet Floor", 36"H, Yellow 1/ea.
17706276 627677 "Caution, Wet Floor", 36"H, Yellow 5/cs.

G. SITE SAFETY HANGING SIGN RUBBERMAID

Sign and pole combination blocks doorway. Torsion action to secure pole. Soft, pliable sign for ease of use and storage. Multi-lingual message.
177090161 9S16 "Closed for Cleaning", 18" x 12", Yellow, 1/ea.

H. WET FLOOR SIGN ZEPHYR

Lightweight, bi-lingual sign warns pedestrians of potential danger in both English and Spanish. Convenient folding design for easy storage.
75085100 45100 "Caution, Wet Floor", 24"H, Yellow 6/cs.

SPILL STATION

I. OVER-THE-SPILL® STATION RUBBERMAID

Slip-resistant pads quickly cover spills and alert pedestrians. Each yellow pad is coded with universal caution symbol and "Caution Wet Floor" message in English and Spanish. Station is constructed of corrugated plastic and mounts on flat surface, easily dispensing medium or large pads. Pads are constructed of melt-blown polypropylene for added strength and absorbency. Large pads absorb up to 16 oz. (0.5 kg) of fluid per pad. Medium pads absorb up to 12 oz. (0.3 kg) of fluid per pad.
177042525 4252 20"L x 16 1/2"W, Yellow, Large Refill Pads 25/cs.

Squeegees/Scrapers/Spray Bottles & Trigger Sprayers



WINDOW SQUEEGEES

A. WINDOW SQUEEGEES CCP

Lightweight and durable ABS plastic handle with aluminum channel. Precision cut rubber blades provide professional, streak-free performance. Handle, blade and channel are pre-assembled.

276024721	2472	12"W	1/ea.
27602473	2473	14"W	12/cs.
276024751	2475	18"W	1/ea.



B. WINDSHIELD WASHERS/SQUEEGEES ZEPHYR

Constructed in an all plastic design which eliminates the danger of scratching glass. Consists of an 8" nylon net covered sponge on one side and a soft rubber squeegee blade on the other. Equipped with a threaded, solid plastic handle.

75082870	50015	15"L Handle	24/cs.
75080143	50020	20"L Handle	24/cs.

FLOOR SQUEEGEES

C. MOSS FOAM RUBBER SQUEEGEE CARLISLE

Metal frame squeegee is perfect for all around floor cleaning. Soft, double foam rubber blade is designed for use on uneven, grouted and smooth surface floors.

63870708	366330	30"W	10/cs.
-----------------	--------	------	--------



D. STRAIGHT FLOOR SQUEEGEE CCP

Heavy zinc plated metal frames with a high grade dual edge, replaceable rubber blades are designed for tapered handles. Straight squeegees feature a steel scraper edge.

276002521	2400	24"W	1/ea.
------------------	------	------	-------



E. WATER WAND STANDARD FLOOR SQUEEGEE UNGER

Squeegee with socket clamp or with installed Acme Insert, and black natural foam rubber.

703505501	MW550	22"W	1/ea.
------------------	-------	------	-------



SCRAPERS

F. SCRAPERS RUBBERMAID

Heat treated carbon steel blade for maximum strength. The blade contains a polished and clear coated protectant against corrosion. Comfortable contoured handle.

17700046	9H16	1 1/2"W, Red	6/cs.
17700010	9H15	3"W, Red	6/cs.



SPRAY BOTTLES & TRIGGER SPRAYERS

G. PLASTIC BOTTLES CCP

Molded of high density polyethylene with a 28/400 neck and molded in graduations.

276091611	916CN	16 oz., Translucent	1/ea.
276092401	924B	24 oz., Translucent	1/ea.
27601547	932	32 oz., Translucent	100/cs.



H. PROSAFE™ SPRAYERS CCP

Bottles with 922H sprayers. These bottles come in a pack of three, have a product check-off grid and provides bilingual information to help compliance with the "Right to Know" regulations.

276002565	9023RW	24 oz., White/Red	3/cs.
------------------	--------	-------------------	-------

Spray Bottle/Sprayers/Pumps/Buckets



CLEANING TOOLS



A. SPRAY BOTTLE **DIVERSEY**
 Pre-printed spray bottle for diluted cleaner spray applications. Silk-screened, color-coded spray bottles make proper product identification easy.
15203921 3918 32 oz., Glance™ 12/cs.



B. SPRAY-PRO™ TRIGGER SPRAYERS **CCP**
 Designed for heavy-duty, long-term industrial applications ranging from car care to window cleaners. Features a leak-proof nozzle capable of delivering a consistent spray pattern that is adjustable from a full "off" position to a fine, atomized mist to a powerful jet stream.
276009011 902RW7 8³/₄", Red/White 1/ea.
276009021 902BW9 9³/₄", Blue/White 10/cs.
27600024 902RW9 9³/₄", Red/White 200/cs.



TANK SPRAYER

C. HUSKEE™ TANK SPRAYER **CCP**
 Sprayer with polyethylene tank. Resists breaking, leaking and chemical corrosion. Pump handle made of corrosion and rust-resistant cold rolled steel. 9" pump stroke. Nozzle adjusts from fine spray to a powerful jet stream to shoot contents up to 30 feet away. Sprayers are designed for easy field maintenance and cleaning. Fully equipped with Viton seals and gaskets. Equipped with pressure relief valve that indicates tank pressure.
27609974 952 2 gal. 1/ea.



PUMPS

D. PLASTIC DRUM PUMP **CCP**
 Fits 5 to 30 gallon drums with a 1/2" or 2" opening. Adjusts to dispense 2, 4, 6, or 8 oz. per stroke. Chemical and acid-resistant design.
276012951 330 10³/₄" Tube, Heavy-Duty 1/ea.



E. PUMP DISPENSER **CCP**
 A unique "hold-down" feature that allows the pump to be secured in the compressed position, ideal for shipping purposes. Unique threaded body disassembles quickly for sanitary cleaning. The body and head are polypropylene for maximum chemical compatibility. Use with cleaners, waxes, food products, cooking oils, hand soap, shampoo and germicidal detergents. Standard with poly flap valve (HDPE). Made from FDA and USDA approved materials.
276005961 10 16¹/₈", White, 1 oz. Pump 1/ea.



BUCKETS

F. HUSKEE™ BUCKETS **CCP**
 Features durable steel handle, built-in pour spout and graduations molded inside.
276014861 8110GY 10 qt., Gray 1/ea.
276014891 8110RD 10 qt., Red 1/ea.
276014951 8114RD 14 qt., Red 1/ea.



G. BRUTE® BUCKETS **RUBBERMAID**
 Heavy-duty thick wall construction. Molded-in graduations for accurate measuring.
177078601 2963GRAY 10 qt., Gray 1/ea.
17707860 2963GRAY 10 qt., Gray 12/cs.
177078621 2963RED 10 qt., Red 1/ea.
177076841 2614GRAY 14 qt., Gray 1/ea.
17707684 2614GRAY 14 qt., Gray 6/cs.
17707686 2614RED 14 qt., Red 6/cs.



H. DOUBLE BUCKET **RUBBERMAID**
 Allows separation of cleaning solution and rinse water. Use with a roller sponge mop for an easy-to-use cleaning system.
17707692 2617GRAY 17 qt., Gray 6/cs.

Tool Holders/Batteries/Step Stools



TOOL HOLDERS

A. SPARTA® SPECTRUM® ALUMINUM BRUSH RACK CARLISLE

Heavy gauge aluminum brush racks keep brooms and brushes handy and secure. Rack helps prevent handle breakage, bristle damage, and damage to walls and counters. Promotes fast drying of brush bristles. Holds up to ten drilled handle brushes or other kitchen tools and equipment. Mounting holes are 16" on center, screws for mounting included.

63870066 4073500 17"L 12/cs.



B. CLOSET ORGANIZER/TOOL HOLDERS RUBBERMAID

Helps increase productivity and efficiency through better tool storage and access. S-hooks hold 5/8" to 1 1/4" handle diameters. Deep double hooks afford easy accessibility. Clip holder for notes and instructions.

177002911 1992 18"L 1/ea.
 177003171 1993 34"L 1/ea.
 17700317 1993 34"L 4/cs.

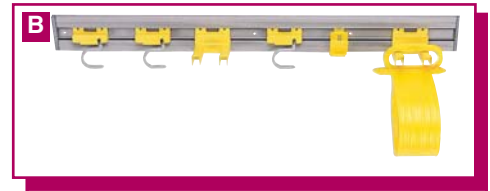

BATTERIES

C. DURACELL® COPPERTOP® BATTERIES PROCTER & GAMBLE

Dependable, long lasting power providing up to a seven year freshness guarantee. Operates reliably in temperature extremes of -4°F to 129°F. Date coded to guarantee freshness. Contains no added mercury.

16900163 MN2400BKD AAA 144/cs.
 16902753 MN1500BKD AA 144/cs.
 16902752 MN1400 C 72/cs.
 16902750 MN1300 D 72/cs.



D. PROCELL® PROFESSIONAL ALKALINE BATTERIES PROCTER & GAMBLE

Manufactured to rigid specifications to meet some of the highest standards of durability and longevity that professional users demand and expect. Deliver outstanding performance with a seven year freshness guarantee backed up with date coding. Rated for reliable operation in temperature extremes from -4°F to 129°F and contain no added mercury.

16903648 PC2400 AAA 144/cs.
 16902148 PC1500 AA 144/cs.
 16901840 PC1400 C 72/cs.
 16902903 PC1300 D 72/cs.
 16902749 PC1604 9V 72/cs.



STEP STOOLS

E. MOBILE TWO-STEP STEP STOOLS RUBBERMAID

Heavy-duty step stool glides easily on retractable rubber casters. Supports loads up to 350 pounds. Soft, slip-resistant pads on both steps. Wheels retract when stepped on. Heavy-duty plastic construction will not damage walls or furniture.

17707630 2523BEIG 16" dia. x 13"H, Beige 1/ea.
 17702521 2523BLA 16" dia. x 13"H, Black 1/ea.



F. TWO-STEP FOLDING STEP STOOL RUBBERMAID

Ideal for maintenance activities and whenever elevation assistance is needed. Slip-resistant surfaces on steps and foot pads. Stands upright when folded and requires minimum space for storage. Easy to transport. Easy to clean and resistant to dents and rust. Supports loads up to 300 pounds.

177042101 420903CYLND Cylinder Color 1/ea.



Carts

CARTS



A. JANITOR CARTS

CCP

Accommodates a 26 or 35 qt. mop bucket with wringer. Heavy-duty, 25 gal. zippered vinyl bag. Non-marking 8" rear wheels, 3" ball-bearing swivel front casters. Vinyl bag replacement and locking compartment available. Two optional locking compartments.

27601140	<i>184BL</i>	55" x 30" x 38", Blue	1/ea.
27601142	<i>184GY</i>	55" x 30" x 38", Gray	1/ea.



B. UTILITY CARTS

CCP

Utility carts featuring 5" heavy-duty, non-marking gray casters for industrial use. Supports 200 pounds per shelf. 400 pound total capacity. Optional center shelf available.

27601378	<i>5800GY</i>	34 ³ / ₈ " x 17 ¹ / ₂ " x 33"H, Gray	1/ea.
27600346	<i>5805BE</i>	40 ³ / ₈ " x 25 ¹ / ₂ " x 33"H, Beige	1/ea.
27600345	<i>5805GY</i>	40 ³ / ₈ " x 25 ¹ / ₂ " x 33"H, Gray	1/ea.



C. CLEANING CARTS W/VINYL BAGS

RUBBERMAID

Smooth, easy-to-clean surface. Zippered bag for easy trash removal. Non-marking 8" wheels and 4" casters. Optional locking compartment.

17706160	<i>617388</i>	21 ³ / ₄ "W x 46"L x 38 ³ / ₈ "H, Black	1/ea.
17706174	<i>6173BLUE</i>	21 ³ / ₄ "W x 46"L x 38 ³ / ₈ "H, Blue	1/ea.

D. LOCKING JANITOR CART CABINET

RUBBERMAID

Locking janitor cart cabinet. Fits 6173 and 6173-02 carts.

17706181	<i>6181</i>	20"L x 16"W x 11 ¹ / ₄ "H, Yellow, Locking Cabinet	1/ea.
-----------------	-------------	--	-------



E. HIGH CAPACITY CLEANING CART

RUBBERMAID

Flexible, high capacity storage solutions and tool organization. Lock 'N Go bucket attachment. Rubber tool holders, four in front and one in back. Two removable 10 qt. six bottle caddies. Non-rusting and easy cleaning aluminum and structural web plastic construction. Comfort Grip cart handles. Lobby dust pan/vacuum holder. Four safety sign holders. 4" casters and 8" wheels. 5 cubic feet of storage.

17709097	<i>9T72</i>	49 ³ / ₄ "L x 38 ³ / ₈ "H x 21 ³ / ₄ "W, Black	1/ea.
-----------------	-------------	--	-------



F. VINYL REPLACEMENT BAG

RUBBERMAID

High capacity vinyl replacement bag. Designed to enhance productivity. Fits the following cleaning carts: 9T72, 9T73, 9T74, 9T75, 9T79, 9T92.

17709078	<i>9T80</i>	33"L x 17 ¹ / ₂ "H x 10 ¹ / ₂ "W, Yellow	2/cs.
-----------------	-------------	--	-------



G. LADDER CART

RUBBERMAID

Provides greater mobility, enhanced access, safe ladder handling, and minimal storage requirements. Commercial-grade hybrid construction of powder-coated steel and Rubbermaid structural foam. Compact footprint increases maneuverability, requires minimal storage space. Safely carries a 6' ladder without hitting doorways, walls or elevators. Tall profile improves access and offers a more comfortable work height. Fully adaptable to work site requirements, with long-item storage, tool holders and locking cabinets. 500 pound capacity.

17700016	<i>9T58</i>	42"H x 27"W x 31 ¹ / ₂ "L, Black/Red	1/ea.
-----------------	-------------	--	-------



Carts



A. TRADES CART

RUBBERMAID

Four compartmentalized boxes store assorted parts and hardware. Fully enclosed, lockable storage compartment helps keep tools and materials secure. Two storage bins hold essential hand tools and supplies. Carts move easily over hard surfaces, through elevators and doorways. Flat surface at ergonomic height provides convenient work area. Will hold up to 180 pounds on the top shelf and 150 pounds on the bottom shelf.

17706180 6180 38" x 19¹/₄" x 33³/₈" 1/ea.



B. UTILITY CARTS

RUBBERMAID

Perfect for transporting materials, supplies and heavy loads in almost any environment. Ergonomically designed push handle provides optimum hand placement and push height improving control and worker safety. Molded-in storage compartments, holsters, hooks and notches. High density structural resin construction. Easy-access bottom shelf. Best-in-class casters to meet the most demanding environments. 500 pound capacity.

17700090 450088BLA Small, 39" x 17⁷/₈" x 33¹/₄", Black 1/ea.

17702089 452088BEIG Medium, 45¹/₄" x 25⁷/₈" x 33¹/₄", Beige 1/ea.

17702093 452088BLA Medium, 45¹/₄" x 25⁷/₈" x 33¹/₄", Black 1/ea.



C. UTILITY CART

RUBBERMAID

Utility cart with enclosed end panels. Easy-to-clean smooth surfaces. Quiet 4" casters and plastic construction help eliminate noise. User-friendly handles on each end enhances mobility. Structural foam construction. 300 pound total load capacity. Molded-in storage compartment on top shelf.

17700080 335588 31"L x 18"W x 37¹/₂"H, Platinum 1/ea.



D. X-TRA™ EQUIPMENT CART

RUBBERMAID

Sized to carry large loads so you can reduce return trips. Large shelves hold various equipment and supplies. 300 pounds total load capacity, 100 pounds per shelf. Attractive styling ideal for front of house use.

17704095 4095BLA 40⁵/₈"L x 20³/₄"W x 37⁷/₈"H, Black 1/ea.



E. X-TRA™ INSTRUMENT CART

RUBBERMAID

Smooth, easy-to-clean shelves. Lockable doors secure contents. Sliding top drawer. Easy pound-together assembly. Large, non-marking casters. 300 pound load capacity

17700581 4094 40⁵/₈" x 20" x 37¹³/₁₆", Gray 1/ea.



F. X-TRA™ UTILITY CART

RUBBERMAID

Four shelf cart. Sized to carry large loads so you can reduce return trips. Large shelves hold various equipment and supplies. 300 pound total load capacity. Attractive styling ideal for front of house use.

17704097 4096BLA 40⁵/₈"L x 20"W x 51"H, Black 1/ea.



Can Liners



CAN LINERS

A. HIGH DENSITY CAN LINERS

PRIME SOURCE®

High density liners (HDPE).

High Density - Coreless Rolls

76004251	76004251	4 gal., 17" x 18", Natural, 6 MIC	2000/cs.
75004856	75004856	7-10 gal., 23" x 24", Black, 6 MIC	1000/cs.
75004855	75004855	7-10 gal., 23" x 24", Natural, 5 MIC	1000/cs.
76002325	76002325	7-10 gal., 23" x 24", Natural, 8 MIC	10/100/cs.
75001039	75001039	7-10 gal., 24" x 24", Clear, 6 MIC	1000/cs.
75004857	75004857	12-16 gal., 23" x 32", Natural, 5 MIC	1000/cs.
75004858	75004858	12-16 gal., 23" x 32", Natural, 6 MIC	1000/cs.
76000681	76000681	12-16 gal., 23" x 33", Black, 5 MIC	10/100/cs.
76006007	76006007	12-16 gal., 23" x 33", Black, 8 MIC	1000/cs.
75001088	75001088	12-16 gal., 24" x 24", Natural, 8 MIC	1000/cs.
76000799	76000799	12-16 gal., 24" x 33", Black, 7 MIC	10/100/cs.
76002480	76002480	12-16 gal., 24" x 33", Natural, 6 MIC	1000/cs.
75001089	75001089	12-16 gal., 24" x 33", Natural, 8 MIC	20/50/cs.
76006006	76006006	12-16 gal., 24" x 33", Natural, 8 MIC	1000/cs.
75001083	75001083	12-16 gal., 24" x 33", White, 0.65 MIL	500/cs.
76004257	76004257	20-30 gal., 30" x 36", Black, 11 MIC	500/cs.
76004258	76004258	20-30 gal., 30" x 36", Black, 13 MIC	250/cs.
76002481	76002481	20-30 gal., 29" x 35", Natural, 9 MIC	500/cs.
75004860	75004860	20-30 gal., 30" x 36", Natural, 8 MIC	500/cs.
75004861	75004861	20-30 gal., 30" x 36", Natural, 11 MIC	500/cs.
75004862	75004862	20-30 gal., 30" x 36", Natural, 13 MIC	250/cs.
75004863	75004863	20-30 gal., 30" x 36", Natural, 14 MIC	250/cs.
75004864	75004864	20-30 gal., 30" x 36", Black, 9 MIC	500/cs.
76004256	76004256	20-30 gal., 30" x 37", Natural, 8 MIC	500/cs.
75001037	75001037	20-30 gal., 30" x 37", Clear, 10 MIC	500/cs.
75004811	75004811	20-30 gal., 30" x 37", White, 17 MIC	200/cs.
76002482	76002482	33 gal., 32" x 39", Natural, 10 MIC	500/cs.
76000374	76000374	33 gal., 33" x 39", Black, 15 MIC	250/cs.
76006783	76006783	33 gal., 33" x 39", Black, 16 MIC	500/cs.
75004866	75004866	33 gal., 33" x 39", Natural, 9 MIC	250/cs.
75004867	75004867	33 gal., 33" x 39", Natural, 12 MIC	250/cs.
75004869	75004869	33 gal., 33" x 39", Natural, 14 MIC	250/cs.
75000095	75000095	33 gal., 33" x 40", Black, 12 MIC	250/cs.
75001043	75001043	33 gal., 33" x 40", Black, 22 MIC	250/cs.
75001036	75001036	33 gal., 33" x 40", Clear, 12 MIC	500/cs.
75004814	75004814	33 gal., 33" x 40", White, 17 MIC	150/cs.
76000680	76000680	33 gal., 40" x 46", Black, 14 MIC	250/cs.
75004827	75004827	40-45 gal., 39" x 46", White, 0.70 MIL	100/cs.
75004881	75004881	40-45 gal., 40" x 46", Black, 11 MIC	250/cs.
76004043	76004043	40-45 gal., 40" x 46", Black, 15 MIC	250/cs.
76000650	76000650	40-45 gal., 40" x 46", Black, 19 MIC	150/cs.
75004880	75004880	40-45 gal., 40" x 46", Natural, 10 MIC	250/cs.
75004882	75004882	40-45 gal., 40" x 46", Natural, 12 MIC	250/cs.
75004884	75004884	40-45 gal., 40" x 46", Natural, 14 MIC	250/cs.

A. HIGH DENSITY CAN LINERS (CONT.)

PRIME SOURCE®

High Density - Coreless Rolls (Cont.)

75004865	75004865	40-45 gal., 40" x 46", Natural, 14.5 MIC	250/cs.
75004885	75004885	40-45 gal., 40" x 46", Natural, 20 MIC	150/cs.
76006062	76006062	40-45 gal., 40" x 48", Black, 22 MIC	150/cs.
75001033	75001033	40-45 gal., 40" x 48", Clear, 14 MIC	250/cs.
75001032	75001032	40-45 gal., 40" x 48", Clear, 16 MIC	250/cs.
76000951	76000951	40-45 gal., 40" x 48", Natural, 10 MIC	250/cs.
75001094	75001094	40-45 gal., 40" x 48", Natural, 16 MIC	250/cs.
76006064	76006064	40-45 gal., 40" x 48", Natural, 22 MIC	150/cs.
76004247	76004247	40-45 gal., 42" x 47", Black, 14 MIC	200/cs.
76004250	76004250	40-45 gal., 42" x 47", Black, 19 MIC	150/cs.
75004888	75004888	40-45 gal., 42" x 47", Natural, 12 MIC	200/cs.
75004889	75004889	40-45 gal., 42" x 47", Natural, 14 MIC	200/cs.
75004890	75004890	40-45 gal., 42" x 47", Natural, 20 MIC	150/cs.
75004877	75004877	40-45 gal., 43" x 47", Natural, 14.5 MIC	200/cs.
76000456	76000456	40-45 gal., 43" x 48", Black, 16 MIC	200/cs.
76000813	76000813	40-45 gal., 43" x 48", Blue, XX-Heavyweight	150/cs.
75001030	75001030	40-45 gal., 43" x 48", Clear, 14 MIC	250/cs.
75001027	75001027	40-45 gal., 43" x 48", Clear, 17 MIC	200/cs.
75001090	75001090	40-45 gal., 43" x 48", Natural, 16 MIC	200/cs.
75004876	75004876	55 gal., 38" x 57", Black, 15 MIC	200/cs.
76000795	76000795	55 gal., 38" x 57", Black, 19 MIC	150/cs.
76003855	76003855	55 gal., 38" x 57", Black, 20 MIC	150/cs.
75004872	75004872	55 gal., 38" x 57", Natural, 12 MIC	200/cs.
75004873	75004873	55 gal., 38" x 57", Natural, 15 MIC	200/cs.
75004874	75004874	55 gal., 38" x 57", Natural, 19 MIC	150/cs.
76000007	76000007	55 gal., 38" x 58", Natural, 15.3 MIC	200/cs.
75001029	75001029	55 gal., 38" x 60", Clear, 14 MIC	200/cs.
76000950	76000950	55 gal., 36" x 60", Natural, 10 MIC	200/cs.
75001074	75001074	55 gal., 38" x 60", Natural, 13 MIC	200/cs.
75001095	75001095	55 gal., 38" x 60", Natural, 17 MIC	200/cs.
76006065	76006065	55 gal., 38" x 60", Natural, 22 MIC	150/cs.
High Density - Flat Pack			
75001038	75001038	12-16 gal., 24" x 33", Clear, 6 MIC	1000/cs.
76004800	76004800	16 gal., 23" x 32", Natural, 8 MIC	1000/cs.
76004803	76004803	30 gal., 30" x 36", Natural, 8 MIC	500/cs.
75001035	75001035	33 gal., 33" x 40", Clear, 16 MIC	250/cs.
75001055	75001055	40-45 gal., 40" x 48", Clear, 12 MIC	250/cs.
76004805	76004805	45 gal., 39" x 46", Natural, 13 MIC	250/cs.
75001173	75001173	50 gal., 45" x 52", Black, 0.90 MIL	100/cs.
75001028	75001028	55 gal., 38" x 60", Clear, 16 MIC	200/cs.
76004806	76004806	56 gal., 43" x 46", Natural, 13 MIC	200/cs.

Can Liners



CAN LINERS & CONTAINERS

A. LOW DENSITY CAN LINERS

PRIME SOURCE®

Linear low density liners (LLDPE).

76000365	76000365	4 gal., 17" x 17", Black, 0.34 MIL	1000/cs.
76000366	76000366	7 gal., 20" x 21", Black, 0.34 MIL	1000/cs.
76004264	76004264	7-10 gal., 23" x 32", Black, 0.9 MIL	250/cs.
76000502	76000502	7-10 gal., 24" x 24", White, 0.45 MIL	500/cs.
75000092	75000092	12-16 gal., 19" x 14" x 25", Clear, 0.70 MIL	1000/cs.
76000375	76000375	12-16 gal., 24" x 32", Black, 0.45 MIL	500/cs.
76000465	76000465	12-16 gal., 24" x 32", Clear, 0.65 MIL	250/cs.
76000453	76000453	12-16 gal., 24" x 32", White, 0.45 MIL	500/cs.
76000464	76000464	12-16 gal., 24" x 32", White, 0.65 MIL	200/cs.
76002433	76002433	12-16 gal., 24" x 33", Black, 0.36 MIL	10/100/cs.
76004266	76004266	20-30 gal., 30" x 36", Black, 1.1 MIL	200/cs.
76000454	76000454	20-30 gal., 30" x 36", Brown, 0.48 MIL	250/cs.
76000467	76000467	20-30 gal., 30" x 37", Clear, 0.80 MIL	100/cs.
76000380	76000380	33 gal., 33" x 39", Black, 1.10 MIL	150/cs.
76000460	76000460	33 gal., 33" x 39", Brown, 0.45 MIL	250/cs.
75000104	75000104	33 gal., 33" x 39", Gray, 1.30 MIL	100/cs.
76000446	76000446	40-45 gal., 40" x 46", Black, 1.10 MIL	100/cs.
75000097	75000097	40-45 gal., 43" x 49", Silver, 2 MIL	50/cs.
76000461	76000461	55 gal., 36" x 58", Brown, 0.60 MIL	100/cs.
76000466	76000466	55 gal., 36" x 58", Clear, 0.65 MIL	100/cs.
76000447	76000447	55 gal., 38" x 58", Black, 1.10 MIL	100/cs.
76000475	76000475	55 gal., 38" x 58", Clear, 1.10 MIL	100/cs.
76000468	76000468	55 gal., 50" x 43 1/2", White, 1.50 MIL	100/cs.
76000450	76000450	56 gal., 43" x 47", White, 0.75 MIL	100/cs.
76000006	76000006	65 gal., 50" x 48", Black, 1.70 MIL	100/cs.

Low Density - Coreless Rolls

76002424	76002424	7-10 gal., 24" x 24", Black, 0.36 MIL	1000/cs.
76000801	76000801	12-16 gal., 23" x 33", White, 0.47 MIL	500/cs.
75001025	75001025	12-16 gal., 24" x 23", Clear, 0.40 MIL	500/cs.
76000876	76000876	12-16 gal., 24" x 27", Clear, 1.30 MIL	300/cs.
75001023	75001023	12-16 gal., 24" x 32", Black, 0.55 MIL	500/cs.
75004807	75004807	12-16 gal., 24" x 32", White, 0.70 MIL	500/cs.
76004102	76004102	12-16 gal., 24" x 33", Black, 0.36 MIL	1000/cs.
75004806	75004806	12-16 gal., 24" x 33", Black, 12 MIC	500/cs.
76004105	76004105	20-30 gal., 30" x 36", Black, 0.59 MIL	250/cs.
76004265	76004265	20-30 gal., 30" x 36", Black, 0.9 MIL	200/cs.
76004267	76004267	20-30 gal., 30" x 36", Black, 1.30 MIL	150/cs.
75001022	75001022	20-30 gal., 30" x 36", Clear, 1.60 MIL	250/cs.
76004104	76004104	20-30 gal., 30" x 37", Black, .45 MIL	500/cs.
75004810	75004810	20-30 gal., 30" x 37", Black, 13 MIC	500/cs.
76004106	76004106	33 gal., 33" x 39", Black, 0.50 MIL	250/cs.
76004268	76004268	33 gal., 33" x 39", Black, 0.90 MIL	100/cs.
75001021	75001021	33 gal., 33" x 39", Black, 1 MIL	250/cs.
76004269	76004269	33 gal., 33" x 39", Black, 1.1 MIL	100/cs.
75001020	75001020	33 gal., 33" x 39", Black, 1.25 MIL	250/cs.
76004270	76004270	33 gal., 33" x 39", Black, 1.3 MIL	100/cs.

A. LOW DENSITY CAN LINERS (CONT.) PRIME SOURCE®

Low Density - Coreless Rolls (Cont.)

76004271	76004271	33 gal., 33" x 39", Black, 1.50 MIL	10/10/cs.
75001019	75001019	33 gal., 33" x 39", Black, 1.50 MIL	250/cs.
76004272	76004272	33 gal., 33" x 39", Black, 1.7 MIL	100/cs.
76000802	76000802	33 gal., 33" x 40", Black, 1.25 MIL	100/cs.
75004812	75004812	33 gal., 33" x 40", Black, 13 MIC	250/cs.
75004813	75004813	33 gal., 33" x 40", Black, 18 MIC	250/cs.
75001200	75001200	33 gal., 33" x 40", Natural, 0.51 MIL	500/cs.
76004273	76004273	40-45 gal., 40" x 46", Black, 0.9 MIL	100/cs.
75001015	75001015	40-45 gal., 40" x 46", Black, 1 MIL	100/cs.
76004274	76004274	40-45 gal., 40" x 46", Black, 1.1 MIL	100/cs.
75001014	75001014	40-45 gal., 40" x 46", Black, 1.25 MIL	150/cs.
76004275	76004275	40-45 gal., 40" x 46", Black, 1.3 MIL	100/cs.
75001013	75001013	40-45 gal., 40" x 46", Black, 1.50 MIL	100/cs.
76004276	76004276	40-45 gal., 40" x 46", Black, 1.50 MIL	10/10/cs.
76004277	76004277	40-45 gal., 40" x 46", Black, 1.7 MIL	100/cs.
75001012	75001012	40-45 gal., 40" x 46", Black, 2 MIL	100/cs.
75001242	75001242	40-45 gal., 40" x 48", Black, 0.63 MIL	250/cs.
76004111	76004111	40-45 gal., 40" x 48", Black, 17 MIC	250/cs.
75004828	75004828	40-45 gal., 42" x 46", White, 17 MIC	100/cs.
76004279	76004279	40-45 gal., 42" x 47", Black, 0.9 MIL	100/cs.
76004280	76004280	40-45 gal., 42" x 47", Black, 1.1 MIL	100/cs.
76004281	76004281	40-45 gal., 42" x 47", Black, 1.3 MIL	100/cs.
76004283	76004283	40-45 gal., 42" x 47", Black, 1.7 MIL	100/cs.
76004284	76004284	40-45 gal., 42" x 47", Black, 2 MIL	10/10/cs.
75001002	75001002	40-45 gal., 43" x 47", Black, 1.80 MIL	100/cs.
76000804	76000804	40-45 gal., 43" x 48", Black, 1 MIL	10/10/cs.
75001244	75001244	40-45 gal., 43" x 48", Natural, 0.63 MIL	200/cs.
75001284	75001284	55 gal., 34" x 16" x 48", Gray, 1 MIL	100/cs.
75001009	75001009	55 gal., 36" x 58", Black, 0.80 MIL	100/cs.
76004287	76004287	55 gal., 36" x 58", Black, 1.30 MIL	100/cs.
75001008	75001008	55 gal., 36" x 58", Black, 1.50 MIL	100/cs.
76004289	76004289	55 gal., 36" x 58", Black, 1.70 MIL	100/cs.
75001007	75001007	55 gal., 36" x 60", Clear, 2 MIL	100/cs.
76004291	76004291	55 gal., 38" x 57", Black, 0.9 MIL	100/cs.
76004292	76004292	55 gal., 38" x 57", Black, 1.1 MIL	100/cs.
76004293	76004293	55 gal., 38" x 57", Black, 1.3 MIL	100/cs.
76004295	76004295	55 gal., 38" x 57", Black, 1.7 MIL	100/cs.
76004120	76004120	55 gal., 38" x 58", Black, 1.10 MIL	100/cs.
76004294	76004294	55 gal., 38" x 58", Black, 1.50 MIL	10/10/cs.
75001004	75001004	55 gal., 38" x 58", Black, 2 MIL	100/cs.
76004296	76004296	55 gal., 38" x 58", Black, 2 MIL	10/10/cs.
75001204	75001204	55 gal., 38" x 60", Black, 0.87 MIL	150/cs.
76000805	76000805	55 gal., 38" x 60", Black, 1 MIL	10/10/cs.
76003859	76003859	55 gal., 38" x 60", Black, 1.25 MIL	100/cs.
76000806	76000806	55 gal., 38" x 60", Black, 1.25 MIL	10/10/cs.
75001203	75001203	55 gal., 38" x 60", Natural, 0.63 MIL	200/cs.
75004820	75004820	55 gal., 38" x 60", White, 17 MIC	100/cs.

Can Liners



A. LOW DENSITY CAN LINERS (CONT.) PRIME SOURCE®

Low Density - Coreless Rolls (Cont.)

76004650	76004650	55 gal., 46" x 50", Black, 1.25 MIL	100/cs.
76000490	76000490	55-60 gal., 38" x 58", Black, 2 MIL	100/cs.

Low Density - Flat Pack

75001254	75001254	12-16 gal., 23" x 32", Black, 1 MIL	500/cs.
76000455	76000455	20-30 gal., 30" x 36", White, 0.75 MIL	200/cs.
75001255	75001255	20-30 gal., 30" x 37", Black, 1 MIL	250/cs.
76000020	76000020	33 gal., 28" x 48", Gray, 1.40 MIL	200/cs.
76000463	76000463	33 gal., 33" x 39", White, 0.75 MIL	150/cs.
75001257	75001257	33 gal., 33" x 40", Black, 1 MIL	250/cs.
75001258	75001258	33 gal., 33" x 40", Black, 1.50 MIL	100/cs.
75001146	75001146	33 gal., 33" x 40", Black, 1.50 MIL	150/cs.
75001259	75001259	33 gal., 33" x 40", Black, 2 MIL	100/cs.
75001280	75001280	33 gal., 33" x 40", Clear, 0.50 MIL	250/cs.
75001183	75001183	33 gal., 33" x 40", Natural, 0.35 MIL	500/cs.
75001115	75001115	33 gal., 33" x 40", White, 0.74 MIL	150/cs.
75001166	75001166	40-45 gal., 40" x 46", Clear, 1.50 MIL	100/cs.
76000449	76000449	40-45 gal., 40" x 46", White, 0.75 MIL	100/cs.
75001266	75001266	40-45 gal., 40" x 48", Black, 1 MIL	100/cs.
75001267	75001267	40-45 gal., 40" x 48", Black, 1.25 MIL	100/cs.
75001268	75001268	40-45 gal., 40" x 48", Black, 1.50 MIL	100/cs.
75001269	75001269	40-45 gal., 40" x 48", Black, 2 MIL	100/cs.
75001278	75001278	40-45 gal., 40" x 48", White, 0.74 MIL	100/cs.
75001169	75001169	40-45 gal., 43" x 47", Black, 1.20 MIL	100/cs.
75001248	75001248	40-45 gal., 43" x 47", Clear, 1.20 MIL	100/cs.
75001275	75001275	40-45 gal., 43" x 49", Black, 0.65 MIL	100/cs.
75001048	75001048	55 gal., 22" x 16" x 58", Black, 0.60 MIL	250/cs.
75001151	75001151	55 gal., 36" x 58", Black, 1.20 MIL	100/cs.
75001274	75001274	55 gal., 36" x 60", Black, 0.65 MIL	100/cs.
75001276	75001276	55 gal., 36" x 60", White, 0.74 MIL	100/cs.
75001261	75001261	55 gal., 36" x 60", Black, 1.25 MIL	100/cs.
75001262	75001262	55 gal., 36" x 60", Black, 1.50 MIL	100/cs.
75001005	75001005	55 gal., 38" x 58", Black, 1.50 MIL	100/cs.
75001223	75001223	55 gal., 38" x 58", Black, 1.50 MIL	100/cs.
76000476	76000476	55 gal., 38" x 58", Clear, 1.30 MIL	100/cs.
75001155	75001155	55 gal., 38" x 58", Clear, 1.50 MIL	100/cs.
75001124	75001124	55 gal., 38" x 58", Gray, 1.30 MIL	100/cs.
76000462	76000462	55 gal., 38" x 58", White, 0.75 MIL	100/cs.
75001281	75001281	55 gal., 38" x 60", Clear, 0.90 MIL	100/cs.
75001277	75001277	55 gal., 38" x 60", White, 0.74 MIL	100/cs.
75001235	75001235	55 gal., 39" x 56", Gray, 1.70 MIL	50/cs.
75001230	75001230	55 gal., 46" x 50", Black, 1.50 MIL	100/cs.
75001271	75001271	56 gal., 42 $\frac{1}{2}$ " x 49", Black, 1 MIL	100/cs.
75001272	75001272	56 gal., 42 $\frac{1}{2}$ " x 49", Black, 1.50 MIL	100/cs.

A. LOW DENSITY CAN LINERS (CONT.) PRIME SOURCE®

Low Density - Flat Pack (Cont.)

76000452	76000452	56 gal., 43" x 47", Black, 1.10 MIL	100/cs.
75001265	75001265	60 gal., 38" x 60", Black, 1 MIL	100/cs.
75001263	75001263	60 gal., 38" x 60", Black, 1.50 MIL	100/cs.
75001264	75001264	60 gal., 38" x 60", Black, 2 MIL	100/cs.

Wet Bag

75001765	75001765	1/2 gal., 6" x 4" x 14", White	1000/cs.
----------	----------	--------------------------------	----------

B. HIGH DENSITY CAN LINERS

HI-VALU

High density, coreless roll can liners.

Black

73006301	73006301	10 gal., 24" x 24", 6 MIC, 50/Roll	1000/cs.
73006305	73006305	12-16 gal., 24" x 33", 6 MIC, 50/Roll	1000/cs.
73006309	73006309	20-30 gal., 30" x 37", 8 MIC, 25/Roll	500/cs.
73006311	73006311	20-30 gal., 30" x 37", 10 MIC, 25/Roll	500/cs.
73006315	73006315	20-30 gal., 30" x 37", 16 MIC, 25/Roll	500/cs.
73006353	73006353	31-33 gal., 33" x 40", 22 MIC, 25/Roll	250/cs.
73006339	73006339	40-45 gal., 40" x 48", 12 MIC, 25/Roll	250/cs.
73006363	73006363	40-45 gal., 40" x 48", 16 MIC, 25/Roll	250/cs.
73006359	73006359	40-45 gal., 40" x 48", 22 MIC, 25/Roll	150/cs.
73006347	73006347	56 gal., 43" x 48", 14 MIC, 25/Roll	200/cs.
73006349	73006349	56 gal., 43" x 48", 17 MIC, 25/Roll	200/cs.
73006361	73006361	56 gal., 43" x 48", 22 MIC, 25/Roll	150/cs.
73006335	73006335	60 gal., 38" x 60", 17 MIC, 25/Roll	200/cs.
73006357	73006357	60 gal., 38" x 60", 22 MIC, 25/Roll	150/cs.

Natural

73006300	73006300	10 gal., 24" x 24", 6 MIC, 50/Roll	1000/cs.
73006304	73006304	12-16 gal., 24" x 33", 6 MIC, 50/Roll	1000/cs.
73006306	73006306	12-16 gal., 24" x 33", 8 MIC, 50/Roll	1000/cs.
73006308	73006308	20-30 gal., 30" x 37", 8 MIC, 25/Roll	500/cs.
73006310	73006310	20-30 gal., 30" x 37", 10 MIC, 25/Roll	500/cs.
73006314	73006314	20-30 gal., 30" x 37", 16 MIC, 25/Roll	500/cs.
73006318	73006318	31-33 gal., 33" x 40", 11 MIC, 25/Roll	500/cs.
73006322	73006322	31-33 gal., 33" x 40", 16 MIC, 25/Roll	250/cs.
73006338	73006338	40-45 gal., 40" x 48", 12 MIC, 25/Roll	250/cs.
73006340	73006340	40-45 gal., 40" x 48", 14 MIC, 25/Roll	250/cs.
73006362	73006362	40-45 gal., 40" x 48", 16 MIC, 25/Roll	250/cs.
73006358	73006358	40-45 gal., 40" x 48", 22 MIC, 25/Roll	150/cs.
73006344	73006344	56 gal., 43" x 48", 12 MIC, 25/Roll	200/cs.
73006364	73006364	56 gal., 43" x 48", 16 MIC, 25/Roll	200/cs.
73006360	73006360	56 gal., 43" x 48", 22 MIC, 25/Roll	150/cs.
73006332	73006332	60 gal., 38" x 60", 14 MIC, 25/Roll	200/cs.
73006334	73006334	60 gal., 38" x 60", 17 MIC, 25/Roll	200/cs.
73006356	73006356	60 gal., 38" x 60", 22 MIC, 25/Roll	150/cs.

Can Liners



CAN LINERS & CONTAINERS

A. LOW DENSITY LINERS

HI-VALU

Low Density - Flat Pack - Black

Economical heavy-gauge liners made from reprocessed resins. Extra heavy-duty for tough trash applications. 25/roll.

73006373	73006373	33 gal., 33" x 39", 1.5 MIL	100/cs.
73006372	73006372	33 gal., 33" x 39", 2.0 MIL	100/cs.
73006377	73006377	40-45 gal., 40" x 46", 1.5 MIL	100/cs.
73006376	73006376	40-45 gal., 40" x 46", 2.0 MIL	100/cs.
73006379	73006379	56 gal., 43" x 47", 1.5 MIL	100/cs.
73006378	73006378	56 gal., 43" x 47", 2.0 MIL	100/cs.
73006375	73006375	60 gal., 38" x 58", 1.5 MIL	100/cs.
73006374	73006374	60 gal., 38" x 58", 2.0 MIL	100/cs.

Low Density - Coreless Rolls - White

Economical heavy-gauge liners made from reprocessed resins. Extra heavy-duty for tough trash applications.

73006383	73006383	33 gal., 33" x 39", 7.5 MIL	150/cs.
73006385	73006385	40-45 gal., 40" x 46", 7.5 MIL	100/cs.
73006384	73006384	60 gal., 38" x 58", 7.5 MIL	100/cs.

Low Density - Coreless Rolls - Black

Linear low density coreless roll can liners. Black. 25/roll.

73006368	73006368	12-16 gal., 24" x 32", 1.0 MIL	150/cs.
73006369	73006369	33 gal., 33" x 39", 1.2 MIL	500/cs.
73006371	73006371	40-45 gal., 40" x 46", 1.2 MIL	100/cs.
73006370	73006370	60 gal., 38" x 58", 1.2 MIL	100/cs.

B. HIGH DENSITY CAN LINERS

BERRY PLASTICS

EQ Value

Natural, high density can liner. Coreless rolls. Natural.

22660714	VLH386017N	60 gal., 38" x 57", 15 MIC	200/cs.
----------	------------	----------------------------	---------

Rhino-X®

High-performance. Advanced high-density films make these liners extremely tough and strong, even at low gauges. Superior film strength. Superior moisture and vapor barrier properties. Star bottom seal eliminates leaks and odors. Great choice for source reduction. Coreless rolls. Natural.

21050201	HR243306N	12-16 gal., 24" x 33", 6 MIC	1000/cs.
21050202	HR334011N	33 gal., 33" x 40", 11 MIC	500/cs.
21050203	HR366016N	55 gal., 36" x 60", 16 MIC	200/cs.
21050161	HR434816N	56 gal. Glutton, 43" x 48", 16 MIC	200/cs.
21050156	HR386016N	60 gal., 38" x 60", 16 MIC	200/cs.
21050160	HR386022N	60 gal., 38" x 60", 22 MIC	150/cs.

C. LOW DENSITY CAN LINERS

BERRY PLASTICS

Big City®

High-quality blend of virgin LLDPE and recycled content. Ideal for heavy-duty applications, including sharp, heavy and irregular waste. Exceptional strength with good puncture and tear resistance. Coreless rolls. Clear.

21050327	LBR4046XC	40-45 gal., 40" x 46", 0.90 MIL	100/cs.
21050389	LBR3858X2C	60 gal., 38" x 58", 1.20 MIL	100/cs.
21050390	LBR3858X3C	60 gal., 38" x 58", 1.50 MIL	100/cs.

C. LOW DENSITY

CAN LINERS (CONT.)

BERRY PLASTICS

Bulldog™

Eco-friendly Rollpak Bulldog™ liners, which meet or exceed EPA standards for post-consumer waste. Made with up to 70% recycled material, thereby helping to save energy and preserve non-renewable natural resources. Coreless rolls.

61609105	PR60200	60 gal., 38" x 58", Black, 2.00 MIL	50/cs.
----------	---------	-------------------------------------	--------

Magnum® Higher Alpha Olefin

These super hexene liners deliver total confidence. Ideal for industrial, commercial and institutional use. Can be used for everything from paper and general refuse to heavy or sharp waste. Seamless tubular construction. Leak-proof star seal. Coreless rolls. White.

61600040	MX20860W	60 gal., 38" x 58", 0.79 MIL/20 MIC	100/cs.
----------	----------	-------------------------------------	---------

D. PG6 CAN LINERS

BERRY PLASTICS

Cost effective everyday performance. Good puncture and tear resistance. "Green" friendly - made from primarily recycled material. Roll.

22660888	PGR3858X3B	55 gal., 38" x 58", 1.5 MIL, Black	100/cs.
22660938	PGR3858X5B	60 gal., 38" x 58", 2 MIL, Black	100/cs.

E. TRASH BAGS

CLOROX

Glad® 65% Recycled Tall Kitchen

Made from 65 percent total recycled plastic to help conserve natural resources. Carton is made of recycled material. Twist-ties included.

38380071	78112	13 gal., 24" x 30 ³ / ₈ ", .90 MIL, 28 ct.	12/cs.
----------	-------	--	--------

Glad® Drawstring Tall Kitchen

Patented three-layer drawstring: Strong and dependable for quick and easy closing. Easy-to-open, easy-to-close. Even the fullest bags can be closed with one easy cinch. Easy to lift and carry. Transport bag with ease. Strong and sturdy. Avoid messy trash disasters. Use as a laundry bag, organize sports equipment and toys, cover patio furniture, line your cat litter box, store holiday decorations and protect blankets, linens and sweaters. Not recommended for food storage.

38380075	78374	13 gal., 24" x 27 ³ / ₈ ", .90 MIL, 100 ct.	300/cs.
----------	-------	---	---------

Glad® Forceflex® Tall Kitchen Drawstring

Trash bags stretch to prevent rips and tears. The drawstrings make them easy to lift and carry, so even the fullest bags can be closed with one cinch and quickly tossed out. Fits tall garbage bins. White. .90 MIL.

38380355	70355	13 gal., 24" x 28", 38 ct.	6/cs.
38380427	70427	13 gal., 24" x 28", 100 ct.	100/cs.

Glad® Odor Shield Tall Kitchen Bag

Don't just mask odors, neutralize them. Glad® Odor Shield bags have a special technology embedded in the whole bag. Strong, three-layer drawstring cinches make closing easy and dependable.

38380076	78361	13 gal., 24" x 27 ³ / ₈ ", .90 MIL, 40 ct.	6/cs.
----------	-------	--	-------

Can Liners



A. TRASH BAGS (CONT.)

CLOROX

Glad®

Glad® trash bags with sturdy drawstring closures. Three-ply strength to avoid messy trash disasters. Strong, three-layer drawstring cinches to make closing easy and dependable. Easy to lift and carry to make transporting trash easier. Black. 1.1 MIL.

38380313 70313 30 gal., 30" x 34", 90 ct. 90/cs.

Glad® Forceflex® Drawstring

Unique diamond texture stretches around objects to prevent rips and tears. The drawstrings make them no problem to lift and carry, so even the fullest bags can be closed with one cinch and tossed out quickly and easily. 1.05 MIL. 76¹/₈" x 81¹/₈" x 26⁷/₁₆".

38380359 70359 30 gal., 25 ct. 150/cs.

Glad® Forceflex® Extra Strong Large Drawstring

Unique diamond texture stretches around objects to prevent rips and tears. Large sizes can handle big trash loads. Strong drawstring. Black.

38380358 70358 30 gal., 30" x 33", .90 MIL, 70 ct. 70/cs.

Glad® Quick-Tie®

Patented four-flap quick-tie feature allows secure closure. High density polyethylene plastic with star-seal construction. Glad® brand offers strength, durability and dependable performance.

38380079 00079 30 gal., 30" x 34", .85 MIL, 10 ct. 120/cs.

B. HIGH DENSITY CAN LINERS

FORTUNE PLASTICS

High Density - Coreless Roll

High density liners (HDPE). Black.

13800293 CRVHD4048XH 40-45 gal., 40" x 48", 22 MIC 150/cs.

High Density - Flat Folded

High density liners (HDPE).

13802421 SL4048125 40-45 gal., 40" x 48", Clear, 15 MIC 125/cs.

13802422 SL4650MDB 60 gal., 24" x 22" x 50", Brown 100/cs.

13805040 5040CLR 65 gal., 50" x 40", Clear 150/cs.

13805044 HF504416NF 65 gal., 50" x 44", Natural, 16 MIC 150/cs.

Hi-D Tuff® - Flat Folded

Suitable for paper waste and can handle a wet and heavy load. Flat folded.

13800595 HDN2424R 10 gal., 24" x 24", Natural, 6 MIC 1000/cs.

13800600 HDN2433R 15 gal., 24" x 33", Natural, 6 MIC 1000/cs.

13800645 HDN3037R 30 gal., 30" x 37", Natural, 8 MIC 500/cs.

13800640 HDN3037M 30 gal., 30" x 37", Natural, 10 MIC 500/cs.

13800603 HDN3340M 33 gal., 33" x 40", Natural, 9 MIC 500/cs.

13800607 HDN3340X 33 gal., 33" x 40", Natural, 16 MIC 250/cs.

13800834 HDN374612 44 gal., 37" x 46", Clear, 12 MIC 250/cs.

13800610 HDN4048M 45 gal., 40" x 48", Natural, 10 MIC 250/cs.

13800615 HDN4048X 45 gal., 40" x 48", Natural, 16 MIC 250/cs.

13800360 HDN3660H 55 gal., 36" x 60", Natural, 13 MIC 200/cs.

13800129 HDN4348H 56 gal., 43" x 48", Natural, 14 MIC 200/cs.

13800620 HDN4348X 56 gal., 43" x 48", Natural, 17 MIC 200/cs.

13800650 HDN3860H 60 gal., 38" x 60", Natural, 14 MIC 200/cs.

13800655 HDN3860X 60 gal., 38" x 60", Natural, 17 MIC 200/cs.

B. HIGH DENSITY CAN LINERS (CONT.)

FORTUNE PLASTICS

Hi-D Tuff® - Coreless Rolls

High density. Coreless roll. Easily dispensed. Ideal for portion control.

Clear

13800266 CRHD2433H 12-16 gal., 24" x 33", 8 MIC 1000/cs.

13800712 CRHD3660H 60 gal., 36" x 60", 13 MIC 200/cs.

13800606 HCXL6017FP 60 gal., 36" x 60", 17 MIC 6/25/cs.

Natural

13800196 CRHD2022 3¹/₂ gal., 20" x 22", 6 MIC 500/cs.

13800491 CRHD2433M 15 gal., 24" x 33", 8 MIC 1000/cs.

13802424 CRHD2424R 10 gal., 24" x 24", 6 MIC 20/50/cs.

13800065 CRHD2433R 15 gal., 24" x 33", 6 MIC 20/50/cs.

13800191 CRHD3037M 20-30 gal., 30" x 37", 10 MIC 500/cs.

13800104 CRHD3037H 20-30 gal., 30" x 37", 13 MIC 20/25/cs.

13803344 CRHD3340H 33 gal., 33" x 40", 13 MIC 500/cs.

13800033 CRHD3340X 33 gal., 33" x 40", 16 MIC 10/25/cs.

13800192 CRHD4048X 40-45 gal., 40" x 48", 16 MIC 250/cs.

13804048 CRHD4048H 40-45 gal., 40" x 48", 13 MIC 10/25/cs.

13800525 CRHD4048XH 40-45 gal., 40" x 48", 22 MIC 26/6/cs.

13800066 CRHD4348X 56 gal., 43" x 48", 16 MIC 8/25/cs.

13800038 CRHD3860H 60 gal., 38" x 60", 13 MIC 8/25/cs.

13800067 CRHD3860X 60 gal., 38" x 60", 16 MIC 200/cs.

Hi-D Tuff® Enviroplas®

50% recycled high density trash can liner on a coreless roll. Black.

13804822 BCRHD434822 56 gal., 43" x 48", 22 MIC 100/cs.

13804827 BCRHD4348XH 56 gal., 43" x 48", 22 MIC 150/cs.

C. LOW DENSITY CAN LINERS

FORTUNE PLASTICS

Drum Liners

Extra heavy-duty drum liners. Coreless rolls. Clear.

13800695 DL386318CLR 60 gal., 38" x 63", 1.80 MIL 75/l.

Duraliner®

Flat folded. Linear low density recycled municipal bags. Black.

13800433 BCH40 33 gal., 33" x 39", 1.50 MIL 100/cs.

13800274 B3339XH 33 gal., 33" x 39", X-Heavy 100/cs.

13800439 BCX40 33 gal., 33" x 39", 2 MIL 100/cs.

13800270 B3339XXH 33 gal., 33" x 39", XX-Heavy 100/cs.

13800113 BC48 40-45 gal., 40" x 46", 1.30 MIL 100/cs.

13800446 BCH48 40-45 gal., 40" x 46", 1.50 MIL 100/cs.

13800071 B4046XH 40-45 gal., 40" x 46", X-Heavy 100/cs.

13800484 BCX48 40-45 gal., 40" x 46", 2 MIL 100/cs.

13800272 B4046XXH 40-45 gal., 40" x 46", XX-Heavy 100/cs.

13800210 BCH47 56 gal., 43" x 47", 1.50 MIL 100/cs.

13800271 BCX47 56 gal., 43" x 47", 2 MIL 100/cs.

13800280 B4347XH 56 gal., 43" x 47", X-Heavy 100/cs.

13800021 BK60BK 60 gal., 38" x 58", 1 MIL 100/cs.

13800115 BC60 60 gal., 38" x 58", 1.30 MIL 100/cs.

Can Liners



CAN LINERS & CONTAINERS

A. LOW DENSITY CAN LINERS FORTUNE PLASTICS

Duraliner® (Cont.)			
13800114	BCH60	55 gal., 38" x 58", Black, 1.50 MIL	100/cs.
13800048	BC3858XH	60 gal., 38" x 58", Black, X-Heavy	100/cs.
13800638	BCX60	60 gal., 38" x 58", Black, 2 MIL	100/cs.
13800273	BC3858XXH	60 gal., 38" x 58", Black, XX-Heavy	100/cs.
Duraliner® Blue Label Ultimate			
Super strong resin blend. Linear low density. Flat folded.			
13800576	GR33BL	15 gal., 15" x 9" x 31", Gray, 0.60 MIL	500/cs.
13800259	GR37XH	20-30 gal., 30" x 36", Gray, 1.20 MIL	150/cs.
Duraliner® Brown Label			
Paper refuse only. Flat folded.			
13800400	BR24BR	10 gal., 15" x 9" x 23", Brown, 0.35 MIL	1000/cs.
13800410	BR335BR	15 gal., 15" x 9" x 31", Brown, 0.35 MIL	500/cs.
13800411	BR33BR	15 gal., 15" x 9" x 31", Brown, 0.35 MIL	1000/cs.
13800415	CL33BR	15 gal., 15" x 9" x 31", Clear, 0.35 MIL	1000/cs.
Duraliner® Gold Label			
Strong liners for industrial use.			
13800278	BK348GO	56 gal., 43" x 47", Black, 2 MIL	100/cs.
Duraliner® Gold Survivor			
Handles wet and/or heavy load. Tear and puncture resistant.			
13800570	FFG248	56 gal., 22 $\frac{1}{2}$ " x 20" x 47", Rust, 2.0 MIL	100/cs.
Duraliner® Green Label			
For all types of refuse. Heavy grade. Flat folded.			
13800422	BR37GR	20-30 gal., 30" x 36", Brown, 0.59 MIL	250/cs.
13800455	BR40GR	33 gal., 33" x 39", Brown, 0.59 MIL	250/cs.
13800490	BR64GR	55 gal., 36" x 58", Brown, 0.59 MIL	200/cs.
13800498	BR60GR	60 gal., 38" x 58", Brown, 0.59 MIL	200/cs.
Duraliner® Red Label			
Paper and plastic refuse only. Medium grade. Flat folded.			
13800423	BR37RD	20-30 gal., 30" x 36", Brown, 0.49 MIL	250/cs.
13800453	BR40RD	33 gal., 33" x 39", Brown, 0.49 MIL	250/cs.
Duraliner® Silver Label			
Extra strong for heavy-duty jobs. Flat folded.			
13803855	HOB385802	60 gal., 38" x 58", Clear	100/cs.
Duraliner® White Ironman			
Handles wet and/or heavy load. Tear and puncture resistant. Flat folded.			
13800449	IM33WH	15 gal., 24" x 32", White, 0.70 MIL	500/cs.
13800540	IM37WH	20-30 gal., 30" x 36", White, 0.70 MIL	200/cs.
13800542	IM40WH	33 gal., 33" x 40", White, 0.70 MIL	150/cs.
13800548	IM48WH	40-45 gal., 40" x 46", White, 0.75 MIL	100/cs.
13800544	IM248WH	56 gal., 43" x 47", White, 0.75 MIL	100/cs.
13800546	IM60WH	60 gal., 38" x 60", White, 0.75 MIL	100/cs.
Duraliner® Yellow Label			
Heaviest of normal refuse. Flat folded.			
13800503	CL40YL	33 gal., 33" x 39", Clear, 0.80 MIL	250/cs.
13802748	BR48YL	40-45 gal., 40" x 46", Brown, 0.85 MIL	250/cs.
13800412	CL48YL	40-45 gal., 40" x 46", Clear, 0.80 MIL	250/cs.
13800659	CL64YL	55 gal., 36" x 58", Clear, 1.50 MIL	200/cs.

A. LOW DENSITY CAN LINERS (CONT.) FORTUNE PLASTICS

Low Density - Coreless Rolls			
Linear low density liners (LLDPE).			
13803248	CRLD33HB	15 gal., 24" x 32", Black, 0.70 MIL	500/cs.
13803241	CRLD33RW	15 gal., 24" x 32", White, 0.45 MIL	500/cs.
13803242	CRLD37HW	30 gal., 30" x 36", White, 0.70 MIL	200/cs.
13803243	CRLD40HW	33 gal., 33" x 39", White, 0.70 MIL	150/cs.
13803245	CRLD46HW	40-45 gal., 40" x 46", White, 0.70 MIL	100/cs.
13801882	CRLD60HB	55-60 gal., 38" x 58", Black, 0.75 MIL	200/cs.
13803232	CRLD60XHC	55-60 gal., 38" x 58", Clear, 1.05 MIL	10/10/cs.
13803244	CRLD60HW	55-60 gal., 38" x 58", White, 0.75 MIL	100/cs.
Low Density - Flat Folded			
Linear low density liners (LLDPE).			
13800237	PG65251FP	24" x 26" x 43", Black, 1 MIL	100/cs.
13804456	4456XXGR	30" x 14" x 56", Gray, 1.50 MIL	100/cs.
13803817	3858175YEL	55-60 gal., 38" x 58", Yellow, 1.75 MIL	50/cs.
Steel-Tuff			
Premium resin blend for added strength. Individually folded flat bags. Ties included. Flat folded.			
13803770	FT23770	20-30 gal., 30" x 36", Silver, 1.50 MIL	100/cs.
13804070	FT24070	33 gal., 33" x 40", Silver, 1.50 MIL	100/cs.
13804870	FT24870	40-45 gal., 39" x 46", Silver, 1.70 MIL	50/cs.
13806070	FT26070	55 gal., 39" x 56", Silver, 1.70 MIL	50/cs.
13800555	FT24770	56 gal., 43" x 48", Silver, 1.70 MIL	50/cs.

B. COMP-LETE™ COMPOSTABLE BAGS FORTUNE PLASTICS

Offer superior strength and compostability. BPI's "Compostable Logo" is awarded to products that meet ASTM D6400, assuring end users and composters that the bags will biodegrade swiftly and safely during municipal, commercial, or household composting. Will not leave plastic residues in the finished compost. Made from Mater Bi™ material. Ideal for collecting food scraps and yard trimmings for composting. Replacing non-degradable trash bags with compostable ones helps composters reduce processing, separation, and disposal costs while keeping consumers collection bins clean, which encourages participation. Natural. 0.80 MIL.			
13800092	BIO3980R	33 gal., 30" x 39", For Food Scraps	250/cs.
13800088	BIO4685R	40-45 gal., 40" x 46", For Yard Waste	200/cs.

C. SURVIVOR II XTRA HEAVY PLUS FORTUNE PLASTICS

Hexene fortified Survivor II can liners make a significant impact on the environment due to their lighter weight and overall greater carrying capacity, which leads to all-around source reduction.			
13800457	CL40H	33 gal., 33" x 39", Clear, 1.1 MIL	100/cs.

Can Liners



A. HIGH DENSITY BAGS

HERITAGE BAG

High Density - Coreless Rolls

Made from highest quality raw materials. Mineral reinforced to enhance physical properties. Performance bottom seal resists leakage. Top-side dual dispensing box. Reliable, consistent quality. Natural.

38990249	Z4824RNQR01	8-10 gal., 24" x 24", 6 MIC	1000/cs.
38992644	Z4833RNQR01	12-16 gal., 24" x 33", 6 MIC	1000/cs.
38993955	Z4833LNQR01	12-16 gal., 24" x 33", 8 MIC	1000/cs.
38994834	Z4833LNR01	16 gal., 24" x 33", 8 MIC	20/50/cs.
38990251	Z6037HNQR01	20-30 gal., 30" x 37", 13 MIC	500/cs.
38990211	Z6640HNQR02	33 gal., 33" x 40", 13 MIC	500/cs.
38990113	Z6640VNR01	33 gal., 33" x 40", 16 MIC	250/cs.
38993965	Z6640XNQR02	33 gal., 33" x 40", 17 MIC	250/cs.
38994048	Z8048MNR03	40-45 gal., 40" x 48", 12 MIC	250/cs.
38993960	Z8048HNQR02	40-45 gal., 40" x 48", 14 MIC	250/cs.
38990204	Z8048VNR01	40-45 gal., 40" x 48", 16 MIC	250/cs.
38991936	Z8048UNR02	40-45 gal., 40" x 48", 24 MIC	200/cs.
38997446	Z7446VNR01	44 gal., 37" x 46", 16 MIC	250/cs.
38993977	Z8648VNQR03	56 gal., 43" x 48", 16 MIC	90/cs.
38997669	Z8648UNR01	56 gal., 43" x 48", 22 MIC	150/cs.
38991098	Z7660VNQR01	60 gal., 38" x 60", 16 MIC	200/cs.

High Density - Flat Pack

Made from highest quality raw materials. Mineral reinforced to enhance physical properties. Performance bottom seal resists leakage. Top-side dual dispensing box. Reliable, consistent quality. Natural.

38996040	Z6037HN	20-30 gal., 30" x 37", 13 MIC	500/cs.
38990237	Z6640MNQX03	33 gal., 33" x 40", 11 MIC	500/cs.
38993974	Z6640HNQK13	33 gal., 33" x 40", 13 MIC	125/cs.
38993309	Z8048MNQX02	40-45 gal., 40" x 48", 10 MIC	250/cs.
38993976	Z8048VNQK16	40-45 gal., 40" x 48", 16 MIC	100/cs.
38993311	Z8048HNQX01	40-45 gal., 40" x 48", 14 MIC	250/cs.
38990239	Z8648HNQ	56 gal., 43" x 48", 14 MIC	200/cs.
38998650	Z8648VN	56 gal., 43" x 48", 16 MIC	200/cs.
38990245	Z7660HN	60 gal., 38" x 60", 14 MIC	200/cs.
38990212	Z7660VNQ	60 gal., 38" x 60", 16 MIC	200/cs.

Rabbit Ear

High density liners (HDPE).

38995844	58446XNH	56 gal., 42" x 46", Natural, 17 MIC	200/cs.
----------	----------	-------------------------------------	---------

B. LOW DENSITY TRASH BAGS

HERITAGE BAG

Stock

Made from highest quality raw materials. Mineral reinforced to enhance physical properties. Performance bottom seal resists leakage. Top-side dual dispensing box. Clear.

38995664	H6639HCQ	33 gal., 23" x 10" x 39", Heavyweight	250/cs.
38990347	H7658SCQ	60 gal., 38" x 58", Mediumweight	100/cs.
38990808	H7658ECQ	60 gal., 38" x 58", 6 MIC	100/cs.
38995651	H7658HCQ	60 gal., 38" x 58", Heavyweight, 0.70 MIL	200/cs.

B. LOW DENSITY

TRASH BAGS (CONT.)

HERITAGE BAG

Super Tuf

Stock linear low density can liners designed to handle the toughest jobs and fit the most commonly used containers. Clear.

38990368	H6036MCQ	20-30 gal., 16" x 14" x 36", Mediumweight	100/cs.
38990273	H6036HCQ	20-30 gal., 16" x 14" x 36", Heavyweight	250/cs.
38991878	H6639SCQ	33 gal., 23" x 10" x 39"	150/cs.

C. BIOTUF™ COMPOSTABLE BAGS

HERITAGE BAG

Tough on trash, easy on the environment. Superior strength designed for pre- and post-consumer food waste diversion programs. Excellent puncture and tear resistance. Proven lifting strength and load capacity. Odor control, dissipates moisture. 100% biodegradable and compostable. Photodegrades if left by roadside. 100% ASTM D6400 certified degradable, 100% compostable. Light green.

38996649	Y6039SER01	30 gal., 30" x 39", Super Heavy, 1.2 MIL	125/cs.
38996650	Y6848YER01	32 gal., 34" x 48", X-Heavy, 1 MIL	100/cs.
38996651	Y8448YER01	48 gal., 42" x 48", X-Heavy, 1 MIL	100/cs.
38996652	Y9460YER01	64 gal., 47" x 60", X-Heavy, 1 MIL	100/cs.

D. NATURE FRIENDLY®

TRASH BAGS

NATURE FRIENDLY PRODUCTS

Nature Friendly Products' trash bags and liners are designed to meet the requirements of the food service industry and protect the environment. They are fully compostable and biodegradable in approximately 50-100 days in properly maintained compost facilities. These products are made from a polyester-based proprietary resin that is fully certified biodegradable and compostable, meeting the ASTM D6400 Standards for Compostability. They are superior in quality, strength and performance, BPI approved, and non-toxic.

C6937003	G105	55 gal., Large, 0.9 MIL	100/cs.
C6937007	G106	69 gal., Large, 0.9 MIL	80/cs.

E. HEFTY® CINCHSAK® LARGE TRASH BAGS

PACTIV

CinchSak bags feature a drawstring closure that make them easy-to-open, fill to capacity, close, and carry to the curb, all while keeping hands free of garbage.

16201524	E81959	30 gal., Extra Strong	220/cs.
----------	--------	-----------------------	---------

Can & Healthcare Liners/Lawn Bags/Wastebaskets



A. TRASH BAGS

TRELLIS EARTH®

Tall Kitchen

These tall trash bags have a 13 gal. capacity and fit most narrow and tall trash cans. Also for yard clippings or recycling. Once you switch to our biodegradable trash bags, you'll never want to go back to your old bags again. 100% biodegradable and toxin free.

Semi-translucent, have no handles, and are provided folded in a carton.

C4780001 WFB07 13 gal., 23½" x 30", Bioplastic 500/cs.

Commercial

Show your trash who's the boss and who's a friend of a planet. Our trash bags have a 33 gal. capacity and fit most trash cans. You can also use our trash bags for yard waste, leaves, lawn trimmings, or biodegradable kitchen scraps. 100% biodegradable and toxin free. Semi-translucent, have no handles, and are provided folded in a carton.

C4780009 WFB09 33 gal., 32" x 39", Bioplastic 250/cs.



B. BIOHAZARD CAN LINERS

FORTUNE PLASTICS

Manufactured from high grade polyethylene with the biohazard icon. Meets all current D.O.T. specifications.

13800535 CB48FLA 45 gal., 40" x 46", Red, 1.20 MIL 100/cs.



C. GLAD® LAWN & LEAF QUICK-TIE® BAGS

CLOROX

Tough enough for the outdoors and large enough for the big jobs. Let's face it. Mother Nature can be pretty tough. Fortunately these strong, 39 gal. bags can handle whatever Mother Nature dishes out. Plus, with the Quick-Tie® flaps, they're easy-to-close and easy to carry so you can transport even the fullest bag with ease. Designed especially for yard waste. Easy-to-close, no inconvenient twist ties.

38380028 70028 39 gal., 33" x 41", 1.1 MIL, 12 ct. 144/cs.



D. LAWN & LEAF BAGS

DURO BAG

Heavy-duty, self-standing bag for leaves, grass clippings and yard trash. Two-ply kraft paper, outer ply is wet-strength for stability in bad weather. Biodegradable. Compatible for composting programs.

13207089 37089 30 gal., 16" x 12" x 35", Stock Print 60/cs.



E. FIRE-RESISTANT WASTEBASKET

CCP

Injection molded glass-filled material is tough and practical. Seamless construction for easy cleaning. UL Classified.

27602927 2927BN 27½ qt., Brown 6/cs.

F. RECTANGULAR WASTEBASKETS

CCP

Injection molded plastic, seamless construction for easy cleaning. Molded in colors will not crack, peel, chip or scratch.

276010931	1358BK	13½ qt., Black	1/ea.
276010965	1358BN	13½ qt., Brown	1/ea.
276013581	1358GY	13½ qt., Gray	1/ea.
276012431	2818BE	28½ qt., Beige	1/ea.
276012461	2818BK	28½ qt., Black	1/ea.
276012491	2818BN	28½ qt., Brown	1/ea.
276012521	2818GY	28½ qt., Gray	1/ea.
27601252	2818GY	28½ qt., Gray	12/cs.
276013211	4114BE	41¼ qt., Beige	1/ea.
276041151	4114BK	41¼ qt., Black	1/ea.
276013201	4114GY	41¼ qt., Gray	1/ea.



Wastebaskets/Step-On Trash Containers



A. FIRE-RESISTANT WASTEBASKETS RUBBERMAID

Rounded corners add strength and are easy-to-clean. Long-lasting fiberglass resists chips and does not rust. Textured finish helps minimize appearance of surface scratches. California State Fire Marshal (CSFM) approved for fire safety. Tested and classified by Underwriters Laboratories as able to contain burning paper without the wastebasket melting or contributing fuel to the container's contents.

17700365	2540BEIG	7 qt., Beige	6/cs.
17702545	2541BEIG	14 qt., Beige	6/cs.
17700845	2541BLA	14 qt., Black	6/cs.
17702546	2541GRAY	14 qt., Light Gray	6/cs.
177025431	2543BEIG	28 qt., Beige	1/ea.
17702543	2543BEIG	28 qt., Beige	6/cs.
177025531	2543BLA	28 qt., Black	1/ea.
17702553	2543BLA	28 qt., Black	6/cs.
17702554	2543GRAY	28 qt., Light Gray	6/cs.
177025441	2544BEIG	40 qt., Beige	1/ea.
17702544	2544BEIG	40 qt., Beige	4/cs.



B. SOFT WASTEBASKETS RUBBERMAID

Soft wastebasket provides space-efficiency and economical value. Rolled rims add durability and are easy-to-clean. All plastic construction won't chip, rust or dent.

177078361	2955BEIG	13 ⁵ / ₈ qt., Beige, Small	1/ea.
17707836	2955BEIG	13 ⁵ / ₈ qt., Beige, Small	12/cs.
177078381	2955BLA	13 ⁵ / ₈ qt., Black, Small	1/ea.
17707838	2955BLA	13 ⁵ / ₈ qt., Black, Small	12/cs.
177008231	2956BEIG	28 qt., Beige, Medium	1/ea.
17700823	2956BEIG	28 qt., Beige, Medium	12/cs.
177078511	2956BLA	28 qt., Black, Medium	1/ea.
17707851	2956BLA	28 qt., Black, Medium	12/cs.
177008481	2956LGRAY	28 qt., Light Gray, Medium	1/ea.
17700848	2956LGRAY	28 qt., Light Gray, Medium	12/cs.
177078541	2957BEIG	41 ¹ / ₄ qt., Beige, Large	1/ea.
17707854	2957BEIG	41 ¹ / ₄ qt., Beige, Large	12/cs.
177029501	2957BLA	41 ¹ / ₄ qt., Black, Large	1/ea.
17702950	2957BLA	41 ¹ / ₄ qt., Black, Large	12/cs.
17707858	2957LGRAY	41 ¹ / ₄ qt., Light Gray, Large	12/cs.



STEP-ON TRASH CONTAINERS

C. STEP-ON CONTAINER W/RIGID LINER RUBBERMAID

Ideal for hands-free, sanitary refuse disposal. Tight-fitting, overlapping lid to help contain odors. Tough, puncture-resistant, all plastic construction. Quiet, heavy-duty pedal for hands-free sanitary use. Assists in complying with OSHA regulation (Occupational Exposure to Bloodborne Pathogens). Factory Mutual (FM) and California State Fire Marshal (CSFM) approved for fire safety. Rigid liners provide a leak-proof base to help contain liquids.

17700142	6142	4 ¹ / ₂ gal., White	1/ea.
----------	------	---	-------



D. PEDAL ROLLTOP CONTAINER RUBBERMAID

Slim oval shape fits easily in tight spaces. Rolltop lid minimizes airborne odors. Large foot pedal accessible from front and sides. Slim shape fits under counters and out of the way. Factory Mutual (FM) and California State Fire Marshal (CSFM) approved for fire safety. Seamless construction resists leaking. Stainless steel lifting rods provide long-lasting, reliable performance.

17706177	6177BEIG	14 ¹ / ₂ gal., 22 ¹ / ₄ " x 14 ¹¹ / ₁₆ " x 27 ³ / ₁₆ ", Beige	1/ea.
----------	----------	---	-------



Step-On & Trash Containers



A. STEP-ON CONTAINERS/LINER RUBBERMAID

Containers

Hands-free sanitary waste management. Assists in complying with OSHA regulation; 29 CFR 1910.1030 (Occupational Exposure to Bloodborne Pathogens). Factory Mutual (FM) and California State Fire Marshal (CSFM) approved for fire safety. Tight-fitting, overlapping lid to help contain odors. Quiet, heavy-duty pedal for hands-free sanitary use. Tough, puncture-resistant, all plastic construction.

17706144	<i>6143BEIG</i>	8 gal., Beige	1/ea.
17700054	<i>6143RED</i>	8 gal., Red	1/ea.
17706143	<i>6143WHT</i>	8 gal., White	1/ea.
17704461	<i>6144BEIG</i>	12 gal., Beige	1/ea.
17706147	<i>6144RED</i>	12 gal., Red	1/ea.
17706145	<i>6145BEIG</i>	18 gal., Beige	1/ea.
17700145	<i>6145RED</i>	18 gal., Red	1/ea.
17700053	<i>6145WHT</i>	18 gal., White	1/ea.

Rigid Liner

Prolongs the life of your containers. One piece plastic construction for long product life.

17706245	<i>6245</i>	15 gal., Fits 6145	4/cs.
-----------------	-------------	--------------------	-------



B. MOBILE STEP-ON CONTAINERS/LINER RUBBERMAID

Containers

Ideal for hands-free, sanitary refuse disposal. Tight-fitting, overlapping lid to help contain odors. Tough, puncture-resistant, all plastic construction. Quiet, heavy-duty pedal for hands-free sanitary use. Assists in complying with OSHA regulation (Occupational Exposure to Bloodborne Pathogens). Factory Mutual (FM) and California State Fire Marshal (CSFM) approved for fire safety. Optional rigid liners provide a leak-proof base to help contain liquids.

17706146	<i>6146BEIG</i>	23 gal., Beige	1/ea.
17706148	<i>6146RED</i>	23 gal., Red	1/ea.
17706151	<i>6146WHT</i>	23 gal., White	1/ea.

Rigid Liner

Prolongs the life of your containers. One piece plastic construction for long product life.

17706246	<i>6246</i>	19 gal., Fits 6146	4/cs.
-----------------	-------------	--------------------	-------



TRASH CONTAINERS

C. WALL HUGGER™ HALF ROUND CONTAINERS CCP

Extra large top opening provides easy access. Rounded front and sides allow use where other containers would interfere with traffic. Rolled top edge adds strength and provides convenient area to lift or pull.

276000621	<i>8321BE</i>	21 gal., 28 ³ / ₈ " x 21 ³ / ₄ " x 12", Beige	1/ea.
276083211	<i>8321GY</i>	21 gal., 28 ³ / ₈ " x 21 ³ / ₄ " x 12", Gray	1/ea.



D. WALL HUGGER™ RECTANGULAR CONTAINERS/LID CCP

Containers

The Wall Hugger™ has a sleek and attractive design that holds 23 gal. of waste, but protrudes less than one foot from the wall. The smooth, seamless design provides prolonged life and promotes easy cleaning. A molded-in "Bag Cinch" eliminates the need to tie knots in the polyliner to keep it secure around the receptacle's rim. Molded-in hand grips in the receptacle base provide a secure area to grasp when lifting and dumping.

276083201	<i>8322GY</i>	23 gal., Gray	1/ea.
27608320	<i>8322GY</i>	23 gal., Gray	4/cs.

Drop Shot Lid

Helps to conceal waste while providing an inviting, enlarged opening for waste disposal. The 8⁷/₄" x 16³/₄" opening is the largest available in a Wall Hugger™ style receptacle.

276073251	<i>7325GY</i>	Fits 23 gal. Wall Hugger, Gray	1/ea.
------------------	---------------	--------------------------------	-------

Trash Containers



A. ROUN' TOP WASTE RECEPTACLE CCP

Designed to contain and extinguish a fire (Factory Mutual Approved). Removable top allows easy access. Unique key-way notch secures poly liners with no clumsy straps. Weatherproof design for worry-free outside use.

27601425 1425BE 24 gal., 45¹/₈" x 20³/₈", Beige 1/ea.



B. SWINGLINE™ SQUARE RECEPTACLE BASES/LIDS CCP

Bases

Rolled rim provides strength and convenient area to lift or pull. Reinforced base withstands rough commercial use. Nests for easy storage.

276011861 25BE 25 gal., Beige 1/ea.

27600025 25BE 25 gal., Beige 4/cs.

276003201 32BE 32 gal., Beige 1/ea.

276001731 32GY 32 gal., Gray 1/ea.

Swing Top Lid

Swings open, making refuse disposal easy. Peaked design is counter weighted and automatically closes to hide trash.

276011141 1600BE Fits 25 and 32 gal., 7⁷/₈" x 16¹/₂" Sq., Beige 1/ea.

Tip Top Lid

Gravity, hands-free opening encourages use and automatically closes to hide trash.

276032291 T1700GY Fits #25 & #32 Base, Gray 1/ea.



C. HUSKEE™ ROUND CONTAINERS/LIDS CCP

Containers

Made of engineered resins with a seamless construction to provide maximum strength and easy cleaning. Huskee™ can be used for a range of commercial applications such as refuse collection or food storage. Containers and lids sold separately.

276010091 1001WH 10 gal., White 1/ea.

276011531 2000GY 20 gal., Gray 1/ea.

27601153 2000GY 20 gal., Gray 6/cs.

276011551 2000WH 20 gal., White 1/ea.

27601155 2000WH 20 gal., White 6/cs.

276012761 3200GY 32 gal., Gray 1/ea.

27601276 3200GY 32 gal., Gray 6/cs.

276032021 3200WH 32 gal., White 1/ea.

276044451 4444GY 44 gal., Gray 1/ea.

27604445 4444GY 44 gal., Gray 4/cs.

276099391 4444RD 44 gal., Red 1/ea.

276085071 5500GY 55 gal., Gray 1/ea.

Dome Top Lids

The economic answer wherever large refuse collection in public places is required.

Conveniently sized to fit Huskee™ receptacle. Wide rim and tight fitting door with rain deflector keeps debris and odors in and rain and pests out.

276044561 4456GY Fits 44 gal., Gray 1/ea.

27604456 4456GY Fits 44 gal., Gray 3/cs.

Flat Lids

Lid for round Huskee™ containers.

276011571 2001GY Fits 20 gal., Gray 1/ea.

276020011 2001WH Fits 20 gal., White 1/ea.

276012791 3201GY Fits 32 gal., Gray 1/ea.

27601279 3201GY Fits 32 gal., Gray 6/cs.

276032031 3201WH Fits 32 gal., White 1/ea.

276013361 4445GY Fits 44 gal., Gray 1/ea.

276013401 4445YW Fits 44 gal., Yellow 1/ea.

276085061 5501GY Fits 55 gal., Gray 1/ea.

27608506 5501GY Fits 55 gal., Gray 3/cs.



D. KING KAN® TRASH RECEPTACLES CCP

Molded of structural plastic for increased durability. Can be used for indoor and outdoor applications. Lid features two heavy-duty plated steel hinges that eliminates awkward lifting, removing and repositioning of the lid. The lid sits tightly on the base to control odors, insects and pests.

27601371 5735BN 35 gal., 39¹/₂" x 20" x 20", Brown 1/ea.

27601376 5750BN 50 gal., 40¹/₂" x 23³/₄" x 23³/₄", Brown 1/ea.





Trash Containers

CAN LINERS & CONTAINERS



A. ASH/TRASH CLASSIC CONTAINER RUBBERMAID

Combines waste and smoking management. Designed for indoor and protected outdoor environments. Ashtray can be permanently attached or left unattached for easy emptying. Rugged construction resists dents and scratches. Retainer hardware secures and conceals polyliner bags. Textured finish helps minimize appearance of surface scratches. California State Fire Marshal (CSFM) approved for fire safety.

17708288 818288BEIG 25 gal., Beige, w/out Doors 1/ea.

B. ATRIUM® WASTE CONTAINERS RUBBERMAID

Ideal for use in airports, office buildings and malls. Fire safe construction. Corrosion resistant, fire safe, and ADA compliant. Plastic liners prevent leakage. Constructed of heavy gauge material.

17700923 9066MSSTL 15 gal., 14^{5/8}" dia. x 28^{1/2}"H, Mirror Stainless Steel 1/ea.

17709079 9079SALUM 35 gal., 18" dia. x 32^{1/4}"H, Satin Aluminum 1/ea.



C. MARSHAL® CONTAINERS RUBBERMAID

Classic

Practical good looks combined with fire safety. Factory Mutual (FM) and California State Fire Marshal (CSFM) approved for fire safety. Includes retainer hardware for securing and concealing polyliner bags. Textured finish helps minimize appearance of surface scratches.

17706088 816088BEIG 15 gal., Beige 1/ea.

17706089 816088BLA 15 gal., Black 1/ea.

17706090 816088BRN 15 gal., Brown 1/ea.

17707088 817088BEIG 25 gal., Beige 1/ea.

17707089 817088BLA 25 gal., Black 1/ea.

17706094 817088BRN 25 gal., Brown 1/ea.

17707091 817088OWHT 25 gal., Off White 1/ea.

Waste

Excellent for indoor applications. Fire-safe construction, ADA compliant. Stainless steel containers constructed of #304 material. Powder coat containers constructed of heavy gauge galvanized steel. Self-closing, reinforced, mirror-polished stainless steel door. Stainless steel, corrosion-resistant reinforcing bottom rim protects floors. Recessed hand grips offer easy lifting for refuse removal. Equipped with rigid liners.

17709624 9624MSSTL 15 gal., 15^{1/4}" dia. x 36^{1/2}"H, Mirror Stainless 1/ea.



D. SLIM JIM® CONTAINERS/LIDS RUBBERMAID

Wall Mount Container

Attractive design blends with most decors. Wall mounting keeps the container out of pedestrian traffic and allows for floor cleaning. California State Fire Marshal (CSFM) approved for fire safety. Factory Mutual approved for fire safety when wall mounted.

17707819 7822BEIG 15 gal., Beige 1/ea.

Waste Containers

Efficient size and shape fits tight spaces. Durable, all plastic construction is easy-to-clean and provides long life. All Slim Jim® tops fit on all Slim Jim® containers.

177008581 3540BEIG 23 gal., Beige 1/ea.

17700858 3540BEIG 23 gal., Beige 4/cs.

177079851 3540BLA 23 gal., Black 1/ea.

17707985 3540BLA 23 gal., Black 4/cs.

177079861 3540BRN 23 gal., Brown 1/ea.

17707986 3540BRN 23 gal., Brown 4/cs.

17700432 3540DBLUE 23 gal., Dark Blue 4/cs.

177001231 3540GRAY 23 gal., Gray 1/ea.

17700123 3540GRAY 23 gal., Gray 4/cs.



Trash Containers



A. SLIM JIM® CONTAINERS/LIDS (CONT.)

RUBBERMAID

Waste Containers w/Handles

Efficient size and shape fits tight spaces. Durable, all plastic construction is easy-to-clean and provides long life. All Slim Jim® tops fit on all Slim Jim® containers.

17700859	3541BEIG	15 ⁷ / ₈ gal., Beige	4/cs.
177008601	3541DBLUE	15 ⁷ / ₈ gal., Dark Blue	1/ea.
177035411	3541GRAY	15 ⁷ / ₈ gal., Gray	1/ea.
17703541	3541GRAY	15 ⁷ / ₈ gal., Gray	4/cs.
17703554	3554LGRAY	23 gal., Light Gray	4/cs.

Waste Container w/Venting Channels

Features innovative patent-pending solutions that increase efficiency and improve worker well-being. Integrated, patent-pending venting channels take the strain out of liner removal. Space-saving profile fits virtually anywhere. Four patent-pending can liner cinches improve productivity. Molded-in handles and base grips make lifting and emptying easier.

177001111	354060GRAY	23 gal., 22"L x 11"W x 30"H, Gray	1/ea.
-----------	------------	-----------------------------------	-------

Swing Lids

Promote recycling and improve productivity. Swing top provides easy access for trash disposal and then swings back to hide trash from public view. Encourage waste separation and recycling with interchangeable, color-coded tops.

177001101	267360BLA	Black	1/ea.
177077881	267360BRN	Brown	1/ea.
17707788	267360BRN	Brown	4/cs.
177026711	267360DBLUE	Dark Blue	1/ea.
177026741	267360GRAY	Gray	1/ea.



B. UNTOUCHABLE® HALF ROUND CONTAINERS/LIDS

RUBBERMAID

Containers

Durable and crack resistant, even under tough indoor/outdoor conditions. Perfect for hotel lobbies, restrooms, shopping malls, restaurants and snack areas.

17703520	3520BEIG	21 gal., Beige	4/cs.
17707976	3520GRAY	21 gal., Gray	4/cs.

Half Round Lids w/Swing Door

Hygienic tops for attractive, hands-free waste disposal. Swing lid design provides easy access and quickly returns to hide refuse from public view. Controls waste, odors, and smoking debris.

177036211	3620BLA	21 ⁵ / ₁₆ " x 12 ⁵ / ₁₆ " x 9 ¹ / ₂ ", Black	1/ea.
17703621	3620BLA	21 ⁵ / ₁₆ " x 12 ⁵ / ₁₆ " x 9 ¹ / ₂ ", Black	4/cs.



C. UNTOUCHABLE® ROUND CONTAINERS

RUBBERMAID

Durable and crack resistant, even under tough indoor/outdoor conditions. Perfect for hotel lobbies, restrooms, shopping malls, restaurants and snack areas.

177029471	2947GRAY	44 ³ / ₈ qt., Light Gray	1/ea.
17700828	3546BEIG	22 gal., Beige	4/cs.
177079941	3546GRAY	22 gal., Gray	1/ea.
17707994	3546GRAY	22 gal., Gray	4/cs.



D. UNTOUCHABLE® SQUARE CONTAINERS/LIDS

RUBBERMAID

Containers

Durable and crack resistant, even under tough indoor/outdoor conditions. Perfect for hotel lobbies, restrooms, shopping malls, restaurants and snack areas.

17708002	3568GRAY	19 gal., 14 ¹ / ₂ " sq. x 24"H, Gray	4/cs.
17708006	3569BEIG	23 gal., 14 ¹ / ₂ " sq. x 28"H, Beige	4/cs.
177080541	3958BEIG	35 gal., 19 ¹ / ₂ " sq. x 27 ⁵ / ₈ "H, Beige	1/ea.
17708054	3958BEIG	35 gal., 19 ¹ / ₂ " sq. x 27 ⁵ / ₈ "H, Beige	4/cs.
177039581	3958GRAY	35 gal., 19 ¹ / ₂ " sq. x 27 ⁵ / ₈ "H, Gray	1/ea.
17703958	3958GRAY	35 gal., 19 ¹ / ₂ " sq. x 27 ⁵ / ₈ "H, Gray	4/cs.
17703959	3959BEIG	50 gal., 19 ³ / ₄ " sq. x 34"H, Beige	4/cs.
177039601	3959GRAY	50 gal., 19 ³ / ₄ " sq. x 34"H, Gray	1/ea.
17703960	3959GRAY	50 gal., 19 ³ / ₄ " sq. x 34"H, Gray	4/cs.

Square Containers w/Can Liner Cinch

177080081	356988BEIG	23 gal., Beige	1/ea.
17706988	356988GRAY	23 gal., Gray	4/cs.



CAN LINERS & CONTAINERS



Trash Containers

CAN LINERS & CONTAINERS



A. UNTOUCHABLE® SQUARE CONTAINERS/LIDS (CONT.)

RUBBERMAID

Square Drop Tops

For hygienic, hands-free refuse disposal. Drop and swing lid designs provide easy access for refuse disposal and then quickly return to hide refuse from public view. Controls waste, odors and smoking debris.

17700210	2689LGRAY	Fits 19/23 gal., Gray	4/cs.
17707772	2664BEIG	Fits 35/50 gal., Beige	4/cs.
177002661	2664GRAY	Fits 35/50 gal., Gray	1/ea.
17700266	2664GRAY	Fits 35/50 gal., Gray	4/cs.

Square Swing Tops

Hygienic top for attractive, hands-free waste disposal. Swing lid design provides easy access and quickly returns to hide refuse from public view. Controls litter, odors and insects. For 3569-07, 3569-88 containers.

177026931	268988BEIG	Fits 19/23 gal., Beige	1/ea.
17702693	268988BEIG	Fits 19/23 gal., Beige	4/cs.
177026941	268988BLA	Fits 19/23 gal., Black	1/ea.

B. BRUTE® ROUND CONTAINERS/LIDS

RUBBERMAID

Containers

All plastic construction will not rust, chip or peel; resists dents. Strong, snap-on lids available for secure, stable stacking. Reinforced rims for added strength and durability. Built-in handles for easy, non-slip lifting; easy anti-jam nesting. Double-ribbed base for increased stability and dragging capacity. Lids and dolly sold separately.



177076781	2610GRAY	10 gal., Gray	1/ea.
17707678	2610GRAY	10 gal., Gray	6/cs.
177076801	2610WHT	10 gal., White	1/ea.
17707680	2610WHT	10 gal., White	6/cs.
177026211	2620DBLUE	20 gal., Dark Blue	1/ea.
177077041	2620WHT	20 gal., White	1/ea.
17707704	2620WHT	20 gal., White	6/cs.
177026321	2632DBLUE	32 gal., Dark Blue	1/ea.
17702632	2632DBLUE	32 gal., Dark Blue	6/cs.
177026531	2632DGRN	32 gal., Dark Green	1/ea.
177077201	2632GRAY	32 gal., Gray	1/ea.
17707720	2632GRAY	32 gal., Gray	6/cs.
177026309	2632GRAY	32 gal., Gray	16/cs.
177077251	2632RED	32 gal., Red	1/ea.
17707725	2632RED	32 gal., Red	6/cs.
177077221	2632WHT	32 gal., White	1/ea.
17707722	2632WHT	32 gal., White	6/cs.
17707729	2632YEL	32 gal., Yellow	6/cs.
17702642	2643DBLUE	44 gal., Dark Blue	4/cs.
177077381	2643GRAY	44 gal., Gray	1/ea.
17707738	2643GRAY	44 gal., Gray	4/cs.
177077389	2643GRAY	44 gal., Gray	12/cs.
177077421	2643RED	44 gal., Red	1/ea.
17707742	2643RED	44 gal., Red	4/cs.
177077401	2643WHT	44 gal., White	1/ea.
17707740	2643WHT	44 gal., White	4/cs.
177026431	2643YEL	44 gal., Yellow	1/ea.
17702643	2643YEL	44 gal., Yellow	4/cs.
177077621	2655GRAY	55 gal., Gray	1/ea.
17707762	2655GRAY	55 gal., Gray	3/cs.

Funnel Top

Funnel top for Brute trash containers.

17707987	3543	Fits 32 gal., Gray	4/cs.
-----------------	------	--------------------	-------

Self-Draining Flat Lids

Self-draining flat lid reduces pooling when containers are stored outside.

177026601	264560BLA	Fits 44 gal., Black	1/ea.
177008611	264560GRAY	Fits 44 gal., Gray	1/ea.

Trash Containers



A. BRUTE® ROUND CONTAINERS/LIDS (CONT.) RUBBERMAID

Snap-On Flat Lids

Strong, snap-on flat lid for secure, stable stacking. All plastic, professional-grade construction will not rust, chip or peel.

177076761	2609WHT	Fits 10 gal., White	1/ea.
177077141	2631GRAY	Fits 32 gal., Gray	1/ea.
17707714	2631GRAY	Fits 32 gal., Gray	6/cs.
17700847	2645GRAY	Fits 44 gal., Gray	4/cs.
177077601	2654GRAY	Fits 55 gal., Gray	1/ea.
17707760	2654GRAY	Fits 55 gal., Gray	3/cs.

Duramold® Dome Tops

Dome top for round Brute containers.

17703788	263788GRAY	Fits 32 gal., Gray	1/ea.
17704788	264788GRAY	Fits 44 gal., Light Gray	1/ea.
17707753	264788RED	Fits 44 gal., Red	1/ea.
17704790	265788GRAY	Fits 55 gal., Gray	1/ea.
17705788	265788RED	Fits 55 gal., Red	1/ea.



B. GLUTTON® TRASH CONTAINERS/LID RUBBERMAID

Containers

Large capacity containers for indoor and outdoor waste handling. Built to withstand extreme weather and handling. Hold down base can be filled with sand or water to provide added stability and security. Perfect for large crowds and high-traffic areas.

17700256	256BBRN	56 gal., Brown	4/cs.
17707256	256BOWHT	56 gal., White	4/cs.

Hooded Top

Trimeld® Glutton hooded top with doors provides added strength and a rain shield.

17707644	256VBRN	Fits 256B, 26 ⁵ / ₈ " x 23" x 13"H, Brown	1/ea.
----------	---------	---	-------



C. LANDMARK SERIES™ DOME TOP CONTAINERS/PANEL RUBBERMAID

Container

Combines durability and style for effective waste collection. Heavy gauge hot dipped galvanized steel provides corrosion resistance. Stone panels have Class A fire rating. Coordinated panels included with product. Ideal for indoor and outdoor applications. UV-stabilized powder coat finish protects color and helps extend product life.

17703979	3973BRN	12 gal., 13 ¹ / ₂ " x 34"H, Brown, Ash/Trash Sand Top	1/ea.
----------	---------	---	-------

Containers w/Hinged Hood

Hinged hood with a stay-open strap for easy access to rigid liner. Rainhood cover with openings on all four sides for convenient refuse collection. Aggregate panels sold separately.

17700318	3970SBLE	35 gal., 26" sq. x 40"H, Sable	1/ea.
17708069	3975SBLE	50 gal., 26" sq. x 46 ¹ / ₂ "H, Sable, w/Rigid Liner	1/ea.

Aggregate Panel

Aggregate panels for Landmark Series™ containers. Natural rock construction.

17704004	4004ROCK	Fits 50 gal., River Rock	4/cs.
----------	----------	--------------------------	-------



D. PLAZA® CONTAINERS RUBBERMAID

Two spring-loaded swing doors help contain odors and control insects. Side-mounted, hinged door offers full interior access for "no lift" refuse removal. Tie-down feature in the container base provides for a secure installation. Molded-in colors and UV inhibitors resist fading. Textured finish helps minimize appearance of surface scratches. Lock latch feature can be used with or without key.

17703964	3964BEIG	50 gal., Beige	1/ea.
17703968	3965BEIG	50 gal., Beige, w/Ashtray	1/ea.
17703963	3964DGRN	50 gal., Dark Green	1/ea.
17703965	3965DGRN	50 gal., Dark Green, w/Ashtray	1/ea.



Trash & Recycling Containers



A. RANGER® CONTAINERS RUBBERMAID

Specifically designed for outdoor use. Built to withstand extreme weather. Ideal for fast food restaurants, municipal parks, playgrounds and stadiums. Tops are permanently attached.

17709418	8430BEIG	35 gal., 19½" sq. x 39¾"H, Beige	1/ea.
17708430	8430BRN	35 gal., 19½" sq. x 39¾"H, Brown	1/ea.

B. SQUARE BRUTE® CONTAINER W/O LID RUBBERMAID

More capacity for storage or refuse collection. Square shape offers up to 14% more capacity than round containers. Nesting handles allow secure fit for side by side use. Rounded corners and smooth contours are easy-to-clean.

17703542	3536GRAY	40 gal., Gray	4/cs.
----------	----------	---------------	-------



C. BRUTE® ROLL OUT CONTAINERS W/LIDS RUBBERMAID

Easy mobility for general refuse collection and material handling. Heavy-duty, one-piece handle provides large, strong grip area. Ground-hugging base is designed for stability even in high winds and on uneven surfaces. Molded-in, reinforced lift points help distribute loads evenly. Inset wheel position helps prevent damage to walls and doorways. Molded-in foot tilter helps maneuver heavy loads. One piece body construction provides superior strength and durability.

17709256	9W27BLUE	50 gal., 28½"L x 23⅜"W x 36½"H, Blue	2/cs.
177092551	9W27GRAY	50 gal., 28½"L x 23⅜"W x 36½"H, Gray	1/ea.
17709255	9W27GRAY	50 gal., 28½"L x 23⅜"W x 36½"H, Gray	2/cs.
17709257	9W27YEL	50 gal., 28½"L x 23⅜"W x 36½"H, Yellow	2/cs.
17709260	9W21GRAY	65 gal., 32⅜"L x 25⅜"W x 41⅜"H, Gray	1/ea.
17709114	9W22GRAY	95 gal., 35⅝"L x 27⅜"W x 45⅜"H, Gray	1/ea.



RECYCLING CONTAINERS

D. COMMERCIAL RECYCLING WASTEBASKET CCP

The low profile design of these rectangular wastebaskets make them ideal for a variety of applications ranging from classroom, office, commercial to institutional use.

276012551	28181	28⅜ qt.	1/ea.
-----------	-------	---------	-------

E. WALL HUGGER™ RECYCLING RECEPTACLE CCP

The Wall Hugger™ has a sleek and attractive design that holds 23 gallons of waste, but protrudes less than one foot from the wall. The smooth, seamless design provides prolonged life and promotes easy cleaning. A molded-in "Bag Cinch" eliminates the need to tie knots in the polyliner to keep it secure around the receptacle's rim. Molded-in hand grips in the receptacle base provide a secure area to grasp when lifting and dumping.

276083271	83221	23 gal.	1/ea.
-----------	-------	---------	-------

F. HUSKEE™ ROUND CONTAINER CCP

Made of engineered resins with a seamless construction to provide maximum strength and easy cleaning. Huskee™ can be used for a range of commercial applications such as refuse collection or food storage. Containers and lids sold separately.

276032011	32001	32 gal., Blue/Recycle	1/ea.
-----------	-------	-----------------------	-------

G. DESKSIDE RECYCLING CONTAINERS RUBBERMAID

An easy and effective way to recycle paper. Contains Post-Consumer Recycled Resin (PCR) exceeding EPA guidelines. Designed to be used in systems with existing office containers and accessories.

177029551	295573	13⅝ qt., Blue, Small	1/ea.
177029561	295673	28 qt., Blue, Medium	1/ea.
17700814	295673	28 qt., Blue, Medium	12/cs.
177029581	295773	41¼ qt., Blue, Large	1/ea.



Recycling Containers



A. RECYCLING BOX

RUBBERMAID

Stackable recycling boxes made out of Post-Consumer Recycled Resin (PCR) perfect for commercial recycling use. Stackable for convenient use of multiple containers at one time and nestable for easy storage and shipping. Inboard handles for easy lifting and carrying meeting municipality container requirements. Made from linear low density polyethylene to withstand harsh weather conditions and heavy use to prevent cracking, denting or bowing. Texture and design prevent liquid and debris build-up providing an easy-to-clean product.

177057141 571473 14 gal., Blue 1/ea.



B. PAPER RECYCLING CONTAINER

RUBBERMAID

Deskside paper recycling system is designed to be used with existing office containers and accessories, Rubbermaid's office paper recycling system is an easy and effective way to collect waste paper. For use in areas of high paper generation, such as near copiers, printers and in mailrooms. Serves as a convenient central collection site for multiple work stations.

177080011 356806 19 gal., 14 1/2" sq. x 24"H, Blue 1/ea.



C. HALF ROUND RECYCLING CONTAINER

RUBBERMAID

For use in areas of high paper generation, such as near copiers, printers and in mailrooms. Station containers serve as a convenient central collection site for multiple work stations. Recommended for indoor and outdoor use. Large capacity ideal for heavy traffic areas. Designed to withstand extreme weather and handling.

177035211 352006BLUE 21 gal., Blue 1/ea.



D. SLIM JIM® RECYCLING CONTAINERS/LIDS

RUBBERMAID

Container

For use in areas of high paper generation, such as near copiers, printers, and in mailrooms. Contains Post-Consumer Recycled Resin (PCR) exceeding EPA guidelines. Station containers serve as a convenient central collection site for multiple work stations. Recommended for indoor and outdoor use.

177035481 354075 23 gal., Blue, 20"L x 11"W x 30"H 1/ea.

17703548 354075 23 gal., Blue, 20"L x 11"W x 30"H 4/ea.

Containers w/Venting Channels

Integrated, patent-pending venting channels take the strain out of liner removal. Space-saving profile fits virtually anywhere. Four patent-pending can liner cinches improve productivity. Molded-in handles and base grips make lifting and emptying easier.

177035471 354007BLUE 23 gal., Blue 1/ea.

177035461 354007GRN 23 gal., Green 1/ea.

Bottle & Can Recycling Tops

Promote recycling and improve productivity. Interchangeable, color-coded tops promote waste separation: slotted blue top for paper; green, blue and brown round-hole tops for glass bottles, jars and metal cans; gray handle tops for general refuse. All tops fit on 3540, 3541, 3554 containers.

177092881 269288BLUE Fits Slim Jim®, Blue 1/ea.

177006321 269288BRN Fits Slim Jim®, Brown 1/ea.

177026921 269288GRN Fits Slim Jim®, Green 1/ea.

Paper Recycling Top

Promote recycling and improve productivity. Interchangeable, color-coded tops promote waste separation: slotted blue top for paper; green, blue and brown round-hole tops for glass bottles, jars and metal cans; gray handle tops for general refuse.

177027031 270388BLUE Fits 3540, 3541, 3554, 20 1/2" x 11 1/2" x 2 3/4", Dark Blue 1/ea.



E. SQUARE RECYCLING CONTAINERS

RUBBERMAID

For use in areas of high paper generation. Contains Post-Consumer Recycled Resin (PCR) exceeding EPA guidelines. Station containers serve as a convenient central collection site for multiple work stations. Recommended for indoor and outdoor use. Large capacity ideal for large crowds and high-traffic areas. Designed to withstand extreme weather and handling.

177039551 395873 35 gal., 19 1/2" sq. x 27 5/8"H, Blue 1/ea.

177059051 395973 50 gal., 19 1/2" sq. x 34 1/4"H, Blue 1/ea.



CAN LINERS & CONTAINERS

Recycling Containers



CAN LINERS & CONTAINERS



A. UNTOUCHABLE® SQUARE RECYCLING CONTAINERS/LIDS RUBBERMAID

Containers

For use in high-volume areas. Sleek design for a professional image. Contains Post-Consumer Recycled Resin (PCR) exceeding EPA guidelines. Patent Pending can liner cinch allows for bag retention and eliminates knot tying. Station containers provide convenient central collection sites for multiple work stations or areas. All containers come standard with the universal recycle symbol imprint.

177035671	356973	23 gal., Blue	1/ea.
17703569	356973	23 gal., Blue	4/cs.

Recycling Tops

For use in areas of high paper generation, such as near copiers, printers and in mailrooms. Station containers serve as a convenient central collection site for multiple work stations. Recommended for indoor and outdoor use. Large capacity ideal for heavy traffic areas. Perfect for large crowds and high-traffic areas. Designed to withstand extreme weather and handling.

177027911	2791	Bottle & Can, Fits 3958-06, 3959-06, Dark Blue	1/ea.
177059071	2794	Paper, Fits 3958-06, 3959-06, Dark Blue	1/ea.



B. BRUTE® ROUND RECYCLING CONTAINERS RUBBERMAID

Recycling Containers w/o Lids

Recycling container without lid. Contains Post-Consumer Recycled Resin (PCR) exceeding EPA guidelines. Transport recyclable waste with ease and efficiency.

177026291	263273	32 gal., Blue	1/ea.
177026801	264373	44 gal., Blue	1/ea.

Easy-to-maneuver. Can serve as central collection containers or shipping containers, reducing the amount of handling. Transport recyclable waste with ease and efficiency.

177032061	263206	32 gal., Blue	1/ea.
-----------	--------	---------------	-------

Mobile Office Paper Collection Container

Can serve as central collection containers or shipping containers, reducing the amount of handling. Heavy-duty wheels roll easily, even over steps or curbing. Transport recyclable waste with ease and efficiency.

177026361	263406	32 gal., Blue	1/ea.
-----------	--------	---------------	-------



C. BRUTE® RECYCLING ROLL OUT CONTAINERS W/LIDS RUBBERMAID

Industry leader in waste and material handling applications. Can serve as central collection containers or shipping containers, reducing the amount of handling. Heavy-duty wheels roll easily even over steps or curbing. Transport recyclable waste with ease and efficiency.

177095291	9W2773	50 gal., Blue	1/ea.
17709127	9W2273	95 gal., Blue	1/ea.

D. BRUTE® RECYCLING SQUARE CONTAINER RUBBERMAID

Easy-to-maneuver. Contains Post-Consumer Recycled Resin (PCR) exceeding EPA guidelines. Can serve as central collection containers or shipping containers, reducing the amount of handling. Transport recyclable waste with ease and efficiency.

177035371	353673	40 gal., 23 1/2" sq. x 28 3/4"H, Blue	1/ea.
-----------	--------	---------------------------------------	-------



Recycling Containers/Caddies/Accessories



A. GLUTTON® RECYCLING CONTAINER/LID RUBBERMAID

Container

Large capacity recycling containers for any outdoor environment. Contains Post-Consumer Recycled Resin (PCR) exceeding EPA guidelines. Station containers serve as a convenient central collection site for multiple work stations. Recommended for indoor and outdoor use. Perfect for large crowds and high-traffic areas. Designed to withstand extreme weather and handling. Accepts two Slim Jim® Containers (3540).

177002641 256B73 56 gal., Blue 1/ea.

Bottle & Can Recycling Top

Fits large capacity recycling containers. Station containers serve as a convenient central collection site for multiple work stations. Recommended for indoor and outdoor use. Large capacity ideal for heavy traffic areas. Dark blue.

17700258 256LDBLUE Fits 256B Containers, 26⁵/₈"L x 23"W x 13"H 1/ea.



B. PLAZA® RECYCLING CONTAINERS RUBBERMAID

Large capacity recycling containers for any outdoor environment. Contains Post-Consumer Recycled Resin (PCR) exceeding EPA guidelines. Station containers serve as a convenient central collection site for multiple work stations. Recommended for indoor and outdoor use. Large capacity ideal for heavy traffic areas.

Bottle & Can

17700968 396873 50 gal., 24³/₄"L x 25¹/₄"W x 42¹/₈"H, Blue 1/ea.

Paper

17700969 396973 50 gal., 25³/₄"L x 25¹/₄"W x 42¹/₈"H, Dark Blue 1/ea.



CADDIES/ACCESSORIES

C. HUSKEE™ CADDY BAGS CCP

Add this adjustable nine pocket caddy bag to a round or square Huskee™ receptacle. Made of nylon reinforced PVC for years of reliable service.

276031751 3175 22" x 19¹/₂", Yellow 1/ea.

27603175 3175 22" x 19¹/₂", Yellow 6/cs.

D. HUSKEE™ MAID CADDY CCP

Handy accessory has a convenient handle to raise and carry or collapse out of the way. Fits round or square Huskee™ receptacles and the 50 gal. Tilt 'n Wheel.

276012671 3155 5" x 9¹/₄" x 16¹/₂", Gray 1/ea.

E. BRUTE® CADDY BAGS RUBBERMAID

Snaps securely onto the rim of Brute® 44 gal. containers (2643 and 2643-60). Durable nylon reinforced vinyl is strong and easy to keep clean. 12 pockets of various sizes to accommodate most cleaning supplies.

177077361 2642 20" dia. x 20¹/₂"H, Yellow 1/ea.

17707736 2642 20" dia. x 20¹/₂"H, Yellow 6/cs.

F. BRUTE® MAID CADDY RUBBERMAID

All purpose caddy is perfect for carrying tools or cleaning supplies for touch-up maintenance. Snaps securely onto Brute® rim (44 gal.), #2643.

177077561 2649GRAY 16" x 9" x 5", Gray 1/ea.

G. BRUTE® RIM CADDY RUBBERMAID

Snaps securely onto the rim of Brute® 44 gal. containers (2643 and 2643-60). User-friendly handles for easy maneuverability and minimal contact with refuse. Easily attach and remove poly-liners. Efficiently dispense smaller liners from inside Brute® container. Spots for bottles wet-floor signs, sponges, lobby dust pan, brushes, liner rolls, gloves, and whatever else you can imagine. Bottles, wet-floor sign and other tools stay in place when bag is unloaded in a full tipped position or an upright position.

17709117 9W87 32¹/₂"L x 26¹/₂"W x 6³/₄"H, Yellow 1/ea.



Dollies/Urns



DOLLIES

A. HUSKEE™ DOLLY

CCP

The easy twist-on, twist-off design allows the dolly to fit 20, 32, 44 and 55 gallon Huskee™ rounds. Features five 3" non-marking swivel casters.

276032551	3255	Fits 20 - 55 gal.	1/ea.
27603255	3255	Fits 20 - 55 gal.	2/cs.

B. BRUTE® DOLLY

RUBBERMAID

Easy mobility and maneuverability of heavy loads. Up to 350 lb. continuous static load rating. All plastic construction resists rust, chipping and denting. Heavy-duty wheels with swivel capabilities provide for ease of mobility.

177077321	2640	Fits 20, 32, 44 & 55 gal. Brute®	1/ea.
17707732	2640	Fits 20, 32, 44 & 55 gal. Brute®	2/cs.
177077329	2640	Fits 20, 32, 44 & 55 gal. Brute®	48/cs.

C. BRUTE® SQUARE DOLLY

RUBBERMAID

Easy mobility and maneuverability of heavy loads. All plastic, professional-grade construction resists rust, chipping and denting. Heavy-duty wheels with swivel capabilities provide for ease of mobility.

177001201	3530	300 lb., Black	1/ea.
17700120	3530	300 lb., Black	2/cs.

D. BRUTE® TRAINABLE DOLLY/PULL HANDLE

RUBBERMAID

Triple your productivity, move three separate Brute® containers at once. Pull handle accessory (#2652) attaches to rim of 44 gal. or 55 gal. BRUTE® containers when not in use. Tilt stabilizer provides an easy way to tilt containers for trash removal.

17707769	265103	250 lb. Dolly, Black	2/cs.
17707771	2652	Pull Handle, Black	2/cs.

E. BRUTE® UNIVERSAL DRUM DOLLY

RUBBERMAID

All plastic, professional-grade construction resists rust, chipping and denting. Heavy-duty wheels with swivel capabilities provide for ease of mobility.

17707758	2650	24 ³ / ₈ " dia. x 7 ¹ / ₂ "H, Black	2/cs.
----------	------	---	-------

F. TANDEM BRUTE® DOLLY

RUBBERMAID

Easy mobility and maneuverability of heavy loads. Allows for a combination of different size Brute containers to suit your needs. Containers can be nested and dolly folded upright for space-saving storage. Heavy-duty 8" wheels and swivel casters. Innovative center hinge design and fixed wheels facilitate smooth transport of uneven loads.

17703538	2646	20 ¹ / ₄ "W x 45"D x 8"H, Black	1/ea.
----------	------	---	-------

URNS

G. DURAMOLD® SMOKING URNS

RUBBERMAID

Smoking Urn

Duramold smoking urn with metal ashtray top blends easily with furniture and fixtures.

17707664	2585BLA	11 ¹ / ₂ " dia. x 19 ¹ / ₂ "H, Black	1/ea.
----------	---------	--	-------

Ash/Trash Smoking Urn

Duramold smoking urn with waste receptacle blends easily with furniture and fixtures. Metal ashtray top and metal liner.

17702586	2586BLA	12 ¹ / ₂ " dia. x 19 ¹ / ₂ "H, Black	1/ea.
----------	---------	--	-------

Urns/Trucks



A. GROUNDSKEEPER™ CIGARETTE WASTE COLLECTORS

RUBBERMAID

Classic style, all-weather solution to an unsightly environmental problem. Restricted opening shields cigarette butts from view, weather and flow of oxygen. Two-piece design makes cleaning quick and easy. Inner galvanized steel canister securely holds large quantities of cigarette waste. Constructed of smooth injection molded plastic, rust resistant and easy-to-clean. Steel base plate adds weight for stability and discourages theft.

17702571 257088BEIG Beige 1/ea.
17702573 257088BLA Black 1/ea.

Tuscan

Tuscan Style, combines clean good looks with easy Groundskeeper™ maintenance. Upscale aesthetic blends with many architectural styles. Stainless steel snuff plate minimizes smoldering. Anchor holes for added security. Inner galvanized steel canister securely holds large quantities of cigarette waste.

17709126 9W30BLA Black 1/ea.



B. INFINITY™ SMOKING RECEPTACLES

RUBBERMAID

Sophisticated styling and all-metal construction for attractive and efficient smoking litter management. Includes unobstructed funnels to reduce jamming during cigarette disposal. High-capacity receptacle for heavy traffic areas. Stainless steel snuff plate minimizes smoldering. Weighted bases and bolt-down options for added stability outdoors. 360° disposal area. Guidance tabs on collars and bases enable simple removal and reattachment of receptacles during cleaning. Domed tops for weather resistance. Integrated padlock tabs provide security against tampering and theft.

17700037 9W32SSBLA 2/3 gal., 11⁵/₈"W x 18"H, Stainless Steel/Black, Wall-Mounted 1/ea.
17700020 9W33BLA 39"H, Black, Holds 5000 Cigarettes, Traditional 1/ea.



TRUCKS

C. PLATFORM TRUCK

CCP

Structural plastic sides add protection against wall and door damage; no bumpers required. Two swivel and two fixed casters provide maximum maneuverability. Heavy-duty, reinforced steel handle.

27605860 5860 700 lb., 24" x 48" Deck, Gray, 5" Casters, Utility 1/ea.



D. TILT TRUCK

CCP

Equipped with deluxe roller bearing wheels and heavy-duty casters. Wheels are inset to fit standard office doorways and to reduce wall and door damage. This tilt truck is easily handled by one person and can be easily cleaned with steam or high pressure hot water.

27608338 5833BK 800 lb., 1.1 cu. yd., Black, Standard 1/ea.



E. TILT TRUCK

CCP

Features one-piece extra strong seamless industrial plastic construction. Inset wheel placement prevents wall/door damage and allows for nesting in shipment and in storage. Fits through standard office doorways. Cover available.

27608398 5839BK 300 lb., Black, Utility 1/ea.

F. CUBE TRUCKS

RUBBERMAID

Efficient for commercial waste collection and bulk material transport. Hinged design allows access without removing lid. Metal frame provides durable support. Conceals loads without reducing capacity. USDA Meat & Poultry Equipment Group Listed. Assists in complying with HACCP guidelines. Diamond wheel placement for maneuverability.

17700307 4612BLA 400 lb., 42³/₄" x 28" x 33", Black 1/ea.
17704621 4616 500 lb., 43³/₄" x 31" x 37", Black 1/ea.
17704622 4619 600 lb., 48" x 34¹/₈" x 36¹/₂", Black 1/ea.



Trucks



A. HEAVY-DUTY UTILITY TRUCKS RUBBERMAID

Metal reinforced truck for heavy-duty waste management, bulk handling and food processing. Diamond wheel placement for maneuverability. Optional domed lid does not reduce storage capacity and a hinged design allows access without removing lid.

17704712	4712	800 lb., 43 ¹ / ₈ "L x 28"W x 33 ⁷ / ₈ "H, 4" Casters	1/ea.
17704716	4716GRAY	1000 lb., 44 ⁷ / ₈ "L x 31"W x 38 ¹ / ₂ "H, 5" Casters, Gray	1/ea.
17704720	4720GRAY	1200 lb., 48 ¹ / ₈ "L x 34"W x 37 ⁷ / ₈ "H, 5" Casters, Gray	1/ea.



B. MEGA BRUTE® MOBILE WASTE COLLECTOR/LID RUBBERMAID

A highly maneuverable and versatile waste collection and sortation system. Innovative design features deliver improved productivity and ease of use. Highly maneuverable "diamond" wheel and caster pattern. Ergonomic, easy-access rear doors. Waste sortation options with Slim Jim® containers and can liner retainer. Integrated storage for cleaning supplies. Highly aesthetic, sleek design. Optional full coverage, hinged lid.

17709076	9W73	120 gal./400 lb., 27 ¹ / ₂ "W x 52 ¹ / ₂ "L x 42 ¹ / ₂ "H, Black	1/ea.
17709075	9W72	Lid Fits 9W73, Black	1/ea.



C. PLATFORM TRUCKS RUBBERMAID

Built for durability. Sturdy structural foam construction won't rust, dent or splinter. Virtually maintenance free.

17700170	4471	2000 lb., 30" x 60", Gray, Polyolefin Casters	1/ea.
w/Crossbar Handles			
17704403	4403	500 lb., 24" x 36", Black, Rubber Casters	1/ea.
17704433	4433	500 lb., 24" x 48", Gray, Rubber Casters	1/ea.
17704436	4436	1000 lb., 24" x 48", Black, Rubber Casters	1/ea.
17704466	4466	1000 lb., 30" x 60", Gray, Rubber Casters	1/ea.



D. TRIPLE® STANDARD DUTY TROLLEY RUBBERMAID

Efficiently transports large bulky loads and then folds flat for easy storage. Sturdy structural foam deck won't rust, dent, chip or peel. Non-skid platform surface helps prevent load shifting. Tough plastic construction is easy on walls and doors. Three-position user-friendly handle lets users push, pull or fold flat for use as a dolly. 5" casters are non-marking.

17704405	4401BLA	400 lb., 32 ¹ / ₂ "L x 20 ¹ / ₂ "W, Black	1/ea.
-----------------	---------	---	-------



E. SPRING PLATFORM TRUCK RUBBERMAID

For waste collection, material transport, and laundry handling. Spring platform brings contents to a convenient working level for safer and less-fatiguing handling of material. Metal frame provides durable support. Conceals loads without reducing capacity. X-Colors (Dark Blue, Red, Yellow, White) available on selected SKUs. USDA Meat and Poultry Equipment Group Listed. Assists in complying with HACCP guidelines. Diamond wheel placement for maneuverability.

17704611	4611	14 cu. yd., 500 lb., 44 ¹ / ₈ " x 31" x 32 ¹ / ₂ "	1/ea.
-----------------	------	--	-------



F. HEAVY-DUTY TILT TRUCK RUBBERMAID

Rotational molded. Industrial strength construction transports heavy loads with ease. Easy-to-handle and maneuver through commercial doorways and onto elevators. Constant force design allows for controlled dumping by one person. Inset wheels protect walls, fixtures and patrons. Smooth surface is easy-to-clean and resists pitting and corroding.

17701309	1306GRAY	1/2 cu. yd., 1400 lb., 60 ¹ / ₂ "L x 28"W x 38 ⁵ / ₈ "H, Gray	1/ea.
-----------------	----------	---	-------

Trucks



A. STRUCTURAL FOAM TILT TRUCKS

RUBBERMAID

Durable molded truck handles heavy loads with ease. Fits through standard commercial doorways and onto elevators easily. Non-marking casters reduce touch-up cleaning. Constant force design allows for controlled dumping by one person. Easy-to-clean and virtually maintenance free. Unique steering wheel handle provides excellent maneuvering capability.

17701012	1011	600 lb., 64 ¹ / ₂ " x 30 ¹ / ₄ " x 38"	1/ea.
17701015	1013	800 lb., 64 ¹ / ₂ " x 30 ¹ / ₄ " x 38"	1/ea.
17701501	9T15	1250 lb., 70 ³ / ₄ " x 33 ¹ / ₂ " x 42 ¹ / ₄ ", Black	1/ea.



B. TILT TRUCKS

RUBBERMAID

Sturdy, plastic construction weighs much less than metal. Easy to handle and maneuver through commercial doorways and onto elevators. Constant force design allows for controlled dumping by one person. Inset wheels protect walls, fixtures and patrons. Smooth surface is easy-to-clean and resists pitting and corroding. Optional domed lids available.

Standard-Duty

17701308	130506	1/2 cu. yd., 750 lb., 60 ¹ / ₂ " x 28" x 38 ⁵ / ₈ ", Dark Blue	1/ea.
17701305	1305GRAY	1/2 cu. yd., 750 lb., 60 ¹ / ₂ " x 28" x 38 ⁵ / ₈ ", Gray	1/ea.
17707318	1025	1 ¹ / ₂ cu. yd., 1000 lb., 80 ¹ / ₂ " x 43" x 49 ¹ / ₂ ", Black	1/ea.

Utility-Duty

17701319	1304	1/2 cu. yd., 450 lb. Capacity, 56 ³ / ₄ " x 28" x 38 ⁵ / ₈ "	1/ea.
17701320	1314	1 cu. yd., 850 lb. Capacity, 72 ¹ / ₄ " x 33 ¹ / ₂ " x 43 ³ / ₄ "	1/ea.



C. TILT TRUCK

RUBBERMAID

Industrial strength construction transports heavy loads with ease. Seamless one-piece molded truck bodies with reinforced lip. Sturdy, plastic construction won't rust, dent, chip, or peel and is easy-to-clean. 4" center swivel back caster provides easy maneuvering. Durable one piece, 10" blow-molded polypropylene inset wheels protect surroundings. Powder coated steel frame for corrosion resistance.

17701800	9T18BLA	1 cu. yd., 600 lb., 72 ¹ / ₄ "L x 33 ¹ / ₂ "W x 43 ³ / ₄ "H, Black	1/ea.
-----------------	---------	--	-------



CAN LINERS & CONTAINERS

Floor Pads



FLOOR PADS

A. PRIME SOURCE® FLOOR PADS

PRIME SOURCE®

Black Stripping Pads

For long-lasting, heavy-duty stripping.

75004989	75004989	12", Black	5/cs.
75004425	75004425	13", Black	5/cs.
75004392	75004392	14", Black	5/cs.
75004404	75004404	15", Black	5/cs.
75004395	75004395	16", Black	5/cs.
75004434	75004434	17", Black	5/cs.
75004398	75004398	18", Black	5/cs.
75004442	75004442	19", Black	5/cs.
75004451	75004451	20", Black	5/cs.
75004459	75004459	21", Black	5/cs.

Dark Blue Safire™ Maximum Performance Stripping Pads

Highly abrasive for maximum stripping power. Recommended for use on machines operating at 175-350 RPM.

75004970	75004970	13", Dark Blue	5/cs.
75004971	75004971	17", Dark Blue	5/cs.
75004446	75004446	20", Dark Blue	5/cs.

Emerald II Stripping Pads

For use with stripping solution to remove even the toughest heel marks and heavy finish buildup. Features include: super open web, highly abrasive, tear resistant, durable and tough and increased efficiency. Durable and aggressive for the toughest stripping jobs.

75004416	75004416	13", Emerald Green	5/cs.
76007860	76007860	16", Emerald Green	5/cs.
75004417	75004417	17", Emerald Green	5/cs.
75004418	75004418	20", Emerald Green	5/cs.

Maximum Performance Stripping Pads

Highly abrasive for maximum stripping power. Recommended for use on machines operating at 175-350 RPM.

75004428	75004428	17", Dark Blue	5/cs.
----------	----------	----------------	-------

Stripping Pads

For stripping heavy-soiled traffic areas such as halls and stairs. Easily removes old finish and wax build-up.

75004411	75004411	13", Brown	5/cs.
75004419	75004419	14", Brown	1/ea.
75004985	75004985	20", Brown	5/cs.

Green Scrubbing Pads

For wet, heavy-duty scrubbing.

75004426	75004426	13", Green	5/cs.
75004495	75004495	14", Green	5/cs.
75004393	75004393	16", Green	5/cs.
75004435	75004435	17", Green	5/cs.
75004443	75004443	19", Green	5/cs.
75004452	75004452	20", Green	5/cs.
75004460	75004460	21", Green	5/cs.

A. PRIME SOURCE® FLOOR PADS (CONT.)

PRIME SOURCE®

Blue Cleaning Pads

Designed for moderate scrubbing or heavy spray cleaning. Use with machine speeds of 175-300+RPM.

75004424	75004424	13", Blue	5/cs.
75004403	75004403	15", Blue	5/cs.
75004433	75004433	17", Blue	5/cs.
75004441	75004441	19", Blue	5/cs.
75004450	75004450	20", Blue	5/cs.
75004458	75004458	21", Blue	5/cs.

Conventional Cleaning Pads

Designed for moderate scrubbing or heavy spray cleaning. Use with machine speeds of 175-300+RPM.

75004972	75004972	14", Blue	5/cs.
75004976	75004976	18", Blue	5/cs.

Aqua Burnisher Pads

A superior soft pad that lightly polishes the floor for a reflective appearance. Recommended for use on machines operating at 1000-3000+ RPM.

75004973	75004973	19", Aqua	5/cs.
75004471	75004471	20", Aqua	5/cs.
75004975	75004975	24", Aqua	5/cs.
75004472	75004472	27", Aqua	5/cs.

Beige UHS Burnishing Pads

A moderately soft burnishing pad for a softer finish.

75004423	75004423	13", Beige	5/cs.
75004432	75004432	17", Beige	5/cs.
75004440	75004440	19", Beige	5/cs.
75004449	75004449	20", Beige	5/cs.
75004457	75004457	21", Beige	5/cs.
75004408	75004408	24", Beige	5/cs.
75004465	75004465	27", 1/4" BH, Beige	5/cs.
75004466	75004466	27", 3/4" CH, Beige	2/cs.

Champagne UHS Burnishing Pads

For wet, medium-duty scrubbing.

75004438	75004438	19", Champagne	5/cs.
75004454	75004454	20", Champagne	5/cs.
75004409	75004409	24", Champagne	5/cs.
75004412	75004412	27", 1/4" BH, Champagne	2/cs.
75004413	75004413	27", 3/4" CH, Champagne	2/cs.

Heavy-Duty UHS Burnishing Pads

Top quality, natural hair burnishing pad with a hard and aggressive binder.

Use with machine speeds of 1000 to 3000+ RPM.			
75004977	75004977	17", Natural	5/cs.
75004978	75004978	19", Natural	5/cs.
75004475	75004475	20", Natural	5/cs.
75004479	75004479	27", Natural	1/ea.

Floor Pads/Bonnets



FLOOR EQUIPMENT

A. PRIME SOURCE® FLOOR PADS (CONT.) PRIME SOURCE®

Light Blue UHS Burnishing Pads

Use where burnishing is required on a frequent basis. Soft binders with fine synthetic fiber create a super soft pad for dry burnishing.

75004437	75004437	19", Light Blue	5/cs.
75004445	75004445	20", Light Blue	5/cs.
75004397	75004397	21", Light Blue	5/cs.
75004410	75004410	24", Light Blue	5/cs.
75004414	75004414	27", 1/4" BH, Light Blue	2/cs.
75004415	75004415	27", 3/4" CH, Light Blue	2/cs.

Natural Coco UHS Pads

Natural lubricating factors contribute to the pad's efficiency. Coconut fibers are both organic and biodegradable. Recommended for use on machines operating at 1500-3000+ RPM.

75004990	75004990	17", Natural	5/cs.
75004991	75004991	19", Natural	5/cs.
75004992	75004992	20", Natural	5/cs.
75004993	75004993	21", Natural	5/cs.

Natural Hair UHS Burnishing Pads

A blend of synthetic fibers and natural hair. Pads last longer with lubricating effect of a hair pad.

75004391	75004391	17", Light-Duty	5/cs.
75004430	75004430	17"	5/cs.
75004470	75004470	18", Light-Duty	5/cs.
75004984	75004984	19", Light-Duty	5/cs.
75004421	75004421	19"	5/cs.
75004399	75004399	20", Light-Duty	5/cs.
75004447	75004447	20"	5/cs.
75004986	75004986	21", Light-Duty	5/cs.
75004455	75004455	21"	5/cs.
75004987	75004987	24", Light-Duty	5/cs.
75004473	75004473	24"	5/cs.
75004474	75004474	27", Light-Duty	2/cs.
75004491	75004491	27", Light-Duty	5/cs.
75004979	75004979	27"	5/cs.
75004463	75004463	27", 1/4" BH	2/cs.
75004464	75004464	27", 3/4" CH	2/cs.

Red Spray Buffing Pads

Used in dry buffing and spray buffing or light scrubbing applications.

75000042	75000042	12", Red	5/cs.
75004980	75004980	12", Red	5/cs.
75004427	75004427	13", Red	5/cs.
75004429	75004429	14", Red	5/cs.
75004406	75004406	15", Red	5/cs.
75004407	75004407	16", Red	5/cs.
75004436	75004436	17", Red	5/cs.
75004981	75004981	18", Red	5/cs.
75004444	75004444	19", Red	5/cs.
75004453	75004453	20", Red	5/cs.
75004461	75004461	21", Red	5/cs.

A. PRIME SOURCE® FLOOR PADS (CONT.) PRIME SOURCE®

Polishing Pads

An ideal pad for light cleaning and dry buffing, producing a sparkling shine. Use with 175-300 rpm machines.

75004997	75004997	20", Tan	5/cs.
White Super Polishing Pads			
Produces a high-gloss, "wet-look" shine in polishing applications.			
75004422	75004422	13", White	5/cs.
75004405	75004405	14", White	5/cs.
75004401	75004401	15", White	5/cs.
75004394	75004394	16", White	5/cs.
75004431	75004431	17", White	5/cs.
75004469	75004469	18", White	5/cs.
75004439	75004439	19", White	5/cs.
75004448	75004448	20", White	5/cs.
75004456	75004456	21", White	5/cs.
75004462	75004462	27", 3/4" CH, White	2/cs.

B. FLOOR PADS CCP

Conventional Thickline Stripping Pads

For long lasting, heavy-duty stripping. Recommended for use on machines operating at 175-350 RPM.

27600446	20014	20", Black	5/cs.
----------	-------	------------	-------

Jackeroo Lite™ Ultra High Speed Burnishing Pads

A natural hair pad that excels in bringing out the luster on softer, buffable floor finishes. Recommended for use on machines operating at 1000-3000+ RPM.

27600322	20442	20", Natural	5/cs.
----------	-------	--------------	-------

Conventional Thickline Spray Buffing Pads

For dry buffing, spray buffing or light-duty scrubbing. Recommended for use on machines operating at 175-300 RPM.

27601975	20050	17", Red	5/cs.
27600085	20053	20", Red	5/cs.

White Super Polishing Pads

For dry polishing or with water to ensure a high gloss. Recommended for use on machines operating at 175 to 350 rpm.

27604417	14417	17", White	5/cs.
----------	-------	------------	-------

BONNETS

C. KING COTTON BONNET™ CARPET BONNETS PRIME SOURCE®

Thick profile pad with looped-end, small diameter cotton yarn provides maximum absorption.

750047861	75004786	17"	1/ea.
75004786	75004786	17"	6/cs.
750047871	75004787	19"	1/ea.
75004787	75004787	19"	6/cs.

Bonnets/Vacuums



A. QUEEN BONNET™ CARPET BONNETS PRIME SOURCE®

Medium profile pad with aggressive scrubbing strips. Constructed of absorbent blended looped-end yarn for extra durability.

75004789	75004789	17"	6/cs.
75004790	75004790	19"	6/cs.
75004788	75004788	21"	6/cs.



B. KING BONNET™ CARPET BONNET CCP

This high profile bonnet has looped yarn for high absorption and durability.

27602016	N002019	19", Standard Nylon Poly	6/cs.
----------	---------	--------------------------	-------

C. QUEEN BONNET™ CARPET BONNET CCP

Medium profile pad with aggressive scrubbing strips. Constructed of absorbent blended looped-end yarn for extra durability.

276070181	N007017	17"	1/ea.
-----------	---------	-----	-------



D. SPIN KLEAN® P-4 BONNETS W/SCRUB STRIPS RUBBERMAID

Low-profile bonnet with scrub strips adds additional scrubbing action for improved cleaning performance. Use with a standard rotary floor machine for intensive carpet maintenance.

17700555	P267	17"	5/cs.
17700269	P269	19"	5/cs.
17700078	P271	21"	5/cs.



VACUUMS

E. BACKPACK VACUUM CLEANER RUBBERMAID

Lightweight with comfortable harness design. Narrow profile for unrestricted mobility. Very quiet operation for day cleaning. Four stage filtration system. Closed bag design and security latches for cleaner air, no leaks. 50' 3-wire cord. Flexible hose, crevice tool, floor tool, aluminum wands, dusting brush, and upholstery tool included. Optional HEPA bags available. CRI Green Label certification for improved indoor air quality. 110 CFM. 100" waterlift. 8A.

17700983	9VBP06	6 qt., 11½"L x 13"W x 21⅛"H	1/ea.
----------	--------	-----------------------------	-------

F. MANUAL HEIGHT UPRIGHT VACUUM CLEANERS RUBBERMAID

Nozzle easily removes for service; no tools required for assembly. Easy to replace bags, brush rollers, and filters. Easy to remove clogs. Electronic indicator lights for full bag and brush jam warnings. On-board tool storage. Optional HEPA filtration kit. CRI Green Label certification for improved indoor air quality. 105 CFM. 98" waterlift. 10A.

17700988	9VMH12	12⅞"L x 12"W x 46"H, 12"	1/ea.
17700987	9VMH15	12⅞"L x 15"W x 46"H, 15"	1/ea.



G. POWER HEIGHT UPRIGHT VACUUM CLEANER RUBBERMAID

Automatic carpet height adjustment for increased productivity. Industry leading 1.8 hp dual motor vacuum provides one pass cleaning, maximizing cleaning performance. Electronic indicator lights for full bag and brush jam warnings. Nozzle easily removes for service; no tools required for assembly. Easy to replace bags, brush rollers, and filters. Easy to remove clogs. On-board tool storage. Optional HEPA filtration kit. CRI Green Label certification for improved indoor air quality. 105 CFM. 98" waterlift. 11A.

17700996	9VPH15	13⅞"L x 15"W x 46"H, 15"	1/ea.
----------	--------	--------------------------	-------



H. TRADITIONAL UPRIGHT VACUUM CLEANER RUBBERMAID

Easy-empty paper bag within cloth bag and bag collar seal for improved indoor air quality. 50' power cord. Six-position carpet height adjustment. Durable metal handle tube and bottom plate. Robust furniture guard. CRI Green Label certification for improved indoor air quality. 156.5 CFM. 7A.

17700986	9VCV12	16½"L x 13⅞"W x 46⅞"H, 12"	1/ea.
----------	--------	----------------------------	-------

Vacuums/Indoor Sweepers/Matting



A. ULTRA LIGHT UPRIGHT VACUUM CLEANER RUBBERMAID

Weighs less than 10 lbs. (without cord). Built-in, center-balanced, "easy-carry" handle. Floating nozzle enables cleaning of both hard and soft floor surfaces. 40' power cord. Large outboard wheels improve maneuverability. No tools required for assembly. Unique extension cord hook allows easy connection to the extension cord. CRI Green Label certification for improved indoor air quality. 79.5 CFM. 4A.

17700999 9VUL12 9²/₅"L x 12¹/₂"W x 46²/₅"H, 12" 1/ea.

INDOOR SWEEPERS

B. HUSKEE™ POWERROTOR™ FLOOR SWEEPER CCP

Floor sweeper cleans hard floors and carpets. The self-cleaning flexible rubber blades beat the floor with high frequency, creating friction and momentum that cleanly transports dirt, food, lint and other debris into the dust compartments. Durable plastic body resists scratches and dents and is easy on walls, doors and furniture.

276053271 5325 9¹/₂"W 1/ea.
27605327 5325 9¹/₂"W 5/cs.

C. BRUSHLESS MECHANICAL SWEEPER RUBBERMAID

Perfect for food service applications. Low profile for easy maneuverability and cleaning under furniture. Clear tinted window tells you when the sweeper needs emptying. Two debris canisters with one-touch emptying doors. Four natural boar bristle corner brushes for fine cleaning.

17700023 4215 7¹/₂" Path, Black 4/cs.

D. DUAL ACTION FLOOR/CARPET SWEEPER RUBBERMAID

Two types of brushes provide maximum cleaning and versatility on bare floors or low pile carpets. Dual debris pans with one-touch cleaning doors. Wide sweep path with protective bumper. Soft rubber wheels and brushes conform to floor surface. Designed for large debris as well as smaller crumbs and dirt. Made of durable galvanized steel and tough ABS plastic.

17704213 421388 7¹/₂" Path, Black 4/cs.

E. FLOOR/CARPET SWEEPER RUBBERMAID

Natural boar-bristle brushes in each corner. Easy open debris pan for effortless cleaning. Constructed of durable galvanized steel and tough ABS plastic. For bare floors or low pile carpets.

17708232 4212GRAY 6¹/₂" Path, Gray 4/cs.

MATTING

F. CLEAN STEP SCRAPER MATS MILLENNIUM MAT

All-rubber mat ideal for any outside entryway. The superior molded tread aggressively scrapes shoes clean of dirt and grime and traps it into the base of the mat. Available in black only. Certified slip-resistant by the National Floor Safety Institute.

C5440150 14030500 3' x 5', Black 1/ea.
C5440151 14040600 4' x 6', Black 1/ea.

G. ECOGUARD® INDOOR MATS MILLENNIUM MAT

Made from 99% recycled material, EcoGuard is the most eco-friendly and ecologically responsible mat ever. Carpeted surface is made from 100% post-consumer PET plastic bottles. The all rubber backing is made from used tires, preventing landfill waste.

C5440200 EG020304 2' x 3', Charcoal 1/ea.
C5440201 EG030504 3' x 5', Charcoal 1/ea.
C5440202 EG031004 3' x 10', Charcoal 1/ea.
C5440203 EG040604 4' x 6', Charcoal 1/ea.

H. FLEX STEP ANTI-FATIGUE MATS MILLENNIUM MAT

Reduces fatigue and discomfort while increasing productivity. Air domes offer flexible and comfortable support, and low-profile beveled edges reduce the risk of tripping. Accepted by the American Podiatric Medical Association. Certified slip-resistant by the National Floor Safety Institute.

C5440300 24020300 2' x 3', Black 1/ea.
C5440301 24030500 3' x 5', Black 1/ea.

Paper Dinnerware



PAPER DINNERWARE

A. PAPER DINNERWARE PRIME SOURCE®

Prime Source® Envy® Dinnerware

For hot and cold foods. Fluted rigid rims for strength. Clay coated. Microwaveable.

Bowls

75002104	75002104	12 oz.	1000/cs.
75002130	75002130	12 oz.	1000/cs.

Plates

75002122	75002122	8 1/2"	500/cs.
75002121	75002121	6", 125 ct.	1000/cs.
75002101	75002101	6", 250 ct.,	1000/cs.
75002102	75002102	7"	1000/cs.
75002123	75002123	9"	500/cs.
75002103	75002103	9",	1000/cs.
75002108	75002108	9", Heavyweight	1000/cs.

Hi-Valu Plates

Uncoated paper plates.

73001000	73001000	6", White, Bulk	1000/cs.
73001001	73001001	6", White	1000/cs.
73001002	73001002	9", White	1000/cs.
73001003	73001003	9", White	1200/cs.

B. NATURE'S OWN GREEN LABEL PAPER PLATES AJM PACKAGING

White uncoated paper plates. Made from 100% paper; a renewable natural resource.

Microwave safe.

10100110	PP6GRNWH	6", 100 ct.	1000/cs.
10100055	PP9GREWH	9", 100 ct.	1000/cs.
10100111	PP9GRNWH	9", 100 ct.	1200/cs.

C. PAPER PLATES AJM PACKAGING

Coated paper plates with fluted edges.

10100061	CP9GOAWH	9", White, Retail Pack	1200/cs.
10100037	CP9AJCWWH14	9", White, Heavy-Duty	500/cs.

Heavy-duty coated smoothwall paper plate.

10100089	CP10AJ004125	10 1/4"	500/cs.
----------	--------------	---------	---------

D. GOURMET® SQUARE BOWLS BRIDGE-GATE ALLIANCE GROUP

Compostable serving ware. Molded fiber pulp product with environmentally advanced technologies, conserving energy and water. Starting with the purest raw materials, the natural byproducts of agricultural waste.

B7280021	BGW24SB	24 oz.	4/125/cs.
B7280020	BGW32SB	32 oz.	2/125/cs.
B7280019	BGW2432L	24/32 oz. Lid	4/125/cs.

E. NATURAL BROWN DINNERWARE BRIDGE-GATE ALLIANCE GROUP

Compostable serving ware. Molded fiber pulp product with environmentally advanced technologies, conserving energy and water. Starting with the purest raw materials, the natural byproducts of agricultural waste.

Bowls

B7280035	BGW4B	4 oz.	8/125/cs.
B7280008	BGW12B	12 oz.	8/125/cs.
B7280032	BGW16B	16 oz.	4/125/cs.

Plates

B7280012	BGW06	6"	8/125/cs.
B7280013	BGW07	7"	8/125/cs.
B7280011	BGW09	9"	4/125/cs.
B7280033	BGW93	9", 3-Compt.	4/125/cs.
B7280009	BGW103	10 1/4", 3-Compt.	4/125/cs.
B7280010	BGW10	10 1/2"	4/125/cs.

Platters

B7280016	BGW710	7" x 10"	4/125/cs.
B7280015	BGW912	9" x 12"	4/125/cs.



BOWLS, PLATES & PLATTERS

Paper Dinnerware



A. SUGARCANE PLATES

ECO-PRODUCTS

Certified compostable by Biodegradable Products Institute (BPI), a third-party agency. Sugarcane is a rapidly renewing resource that takes only 18 months to grow and harvest. Grease and cut resistant, plus microwave and freezer safe. Sturdy, so there is no need to double up.

C6670031	<i>EPP016</i>	6"	1000/cs.
C6670035	<i>EPP013</i>	9"	500/cs.



B. HARVEST COLLECTION™ DINNERWARE

GENPAK

Compostable dinnerware item for foodservice applications. Produced from environmentally friendly, annually renewable resources.

Bowls

34789244	<i>HCB24</i>	24 oz., Harvest Wheat	200/cs.
34789243	<i>HCB32</i>	32 oz., Harvest Wheat	200/cs.
34789245	<i>HCD12</i>	12 oz., Harvest Wheat	1000/cs.

Plates

34789241	<i>HCD06</i>	6", Harvest Wheat	1000/cs.
34789240	<i>HCD09</i>	9", Harvest Wheat	200/cs.
34789238	<i>HCD10</i>	10 1/4", Harvest Wheat	250/cs.
34789237	<i>HCD13</i>	3-Compt., 10 1/4", Harvest Wheat	250/cs.
34789239	<i>HCD39</i>	3-Compt., 9", Harvest Wheat	250/cs.



C. DIXIE® ULTRA® HEAVYWEIGHT DINNERWARE

GEORGIA-PACIFIC

Soak Proof Shield® and multilayer design is cut resistant and helps keep grease from seeping through to the table or tray. Environmentally friendly - can be processed in commercial composting operations where commercial composting is available. Compact, low stacking shape. Microwaveable.

Bowls

15005927	<i>SXB12WS</i>	12 oz., Pathways™, Wise Size™	500/cs.
15005926	<i>SX12PATH</i>	12 oz., Pathways™	1000/cs.

Plates

15005925	<i>SXP9PATH</i>	8 1/2", Pathways™, Wise Size™	500/cs.
15005937	<i>SXP10PATH</i>	10 1/4", Pathways™, Wise Size™	500/cs.



D. DIXIE® ULTRALUX™ PAPER PLATES

GEORGIA-PACIFIC

Everyday plate with multilayer design and Soak Proof Shield® offers strength and rigidity for all kinds of foods. Impress guests and showcase food in an aesthetically-pleasing fashion with Pathways™, the latest product design from Dixie®. With a crisp white background for a clean, pure look and a falling leaf design in natural, contemporary colors, this upscale yet down-to-earth nature theme complements food and reflects industry trends.

15005935	<i>UX6WS</i>	5 7/8", Pathways™, Wise Size™	500/cs.
15005934	<i>UX6PATH</i>	5 7/8", Pathways™	1000/cs.
15005939	<i>UX7WS</i>	6 7/8", Pathways™, Wise Size™	500/cs.
15005938	<i>UX7PATH</i>	6 7/8", Pathways™	1000/cs.
15005932	<i>UX9WS</i>	8 1/2", Pathways™, Wise Size™	500/cs.
15005933	<i>UX9PATH</i>	8 1/2", Pathways™	1000/cs.
15005928	<i>UX9PATHPB</i>	9", Pathways™, Dispenser Box	600/cs.

Paper Dinnerware



A. CHINET® CLASSIC WHITE™ MOLDED FIBER DINNERWARE

HUHTAMAKI

Chinet® Classic White™ premium strength paper tableware is recognized everywhere as a quality product you can rely on for superior strength. Made of 99% reclaimed fiber and is microwaveable. 100% recycled/compostable. Passes BPI/ASTM. Made in the USA. Passes Cedar Grove compostable standards.

Burgundy & Gray

15304628	22506	4 oz., Bowl, Portal	2000/cs.
15304644	22507	12 oz., Bowl, Port	1000/cs.
15304603	22501	6", Plate, Pocket	1000/cs.
15304637	22508	6 ³ / ₄ ", Plate, Pole	1000/cs.
15304610	22502	8 ³ / ₄ ", Plate, Point	500/cs.
15304640	22509	9 ³ / ₄ ", Plate, Poodle	500/cs.
15304612	22510	10 ¹ / ₄ ", Plate, 3-Compt., Poplin	500/cs.
15304670	22505	10 ¹ / ₂ ", Plate, Poplar	500/cs.
15304690	22504	7 ¹ / ₂ " x 10", Oval Platter, Pony	500/cs.

Festival Design

15304658	22607	12 oz., Bowl, Pouch	1000/cs.
15304605	22601	6", Plate, Poem	1000/cs.
15304609	22602	8 ³ / ₄ ", Plate, Polka	500/cs.
15304625	22603	9 ¹ / ₄ ", Plate, 3-Compt., Ponder	500/cs.
15304686	22609	9 ³ / ₄ ", Plate, Potash	500/cs.
15304629	22610	10 ¹ / ₄ ", Plate, 3-Compt., Poke	500/cs.
15304632	22605	10 ¹ / ₂ ", Plate, Porch	500/cs.
15304633	22604	7 ¹ / ₂ " x 10", Oval Platter, Pool	500/cs.
15304646	22618	9 ³ / ₄ " x 12 ¹ / ₂ ", Oval Platter, Potent	500/cs.

White

15306390	21230	12 oz., Bowl, Vital	1000/cs.
15306395	21229	16 oz., Bowl	1000/cs.
15306315	21225	6", Plate, Vacate	1000/cs.
15306330	21226	6 ³ / ₄ ", Plate, Veneer	1000/cs.
15301245	21244	6 ³ / ₄ ", Plate, Verbal (Cash & Carry)	1000/cs.
15306410	21227	8 ³ / ₄ ", Plate, Verdict	500/cs.
15306327	21237	8 ³ / ₄ ", Plate, Varsity (Cash & Carry)	500/cs.
15306345	21203	9", Plate, Vessel	500/cs.
15306355	21228	9 ¹ / ₄ ", Plate, 3-Compt., Vista	500/cs.
15306325	21232	9 ³ / ₄ ", Plate, Vapor	500/cs.
15306360	21204	10 ¹ / ₄ ", Plate, 3-Compt., Vestry	500/cs.
15306365	21217	10 ¹ / ₂ ", Plate, Venture	500/cs.
15306333	21247	10 ¹ / ₂ ", Plate, Vanilla (Cash & Carry)	500/cs.
15306375	21256	7 ¹ / ₂ " x 10", Oval Platter, Vogue	500/cs.
15306370	21257	9 ³ / ₄ " x 12 ¹ / ₂ ", Oval Platter, Vesper	500/cs.



B. PAPER PRO™ NATURALS™ DINNERWARE

HUHTAMAKI

Delivers the operational efficiency, sturdiness and customer satisfaction of molded fiber tableware at a price similar to that of paper plates. No need to double-plate, even with large portions. Made of 100% reclaimed fiber and, unlike paper plates with poly coatings, is biodegradable and compostable.

Bowl

15305780	25780	12 oz.	1000/cs.
----------	-------	--------	----------

Plates

15305774	25774	6"	1000/cs.
15305775	25775	8 ³ / ₄ "	500/cs.
15305777	25777	10 ¹ / ₄ ", 3-Compt.	500/cs.
15305776	25776	10 ¹ / ₂ "	500/cs.

Platter

15305778	25778	7 ¹ / ₂ " x 10"	500/cs.
----------	-------	---------------------------------------	---------



BOWLS, PLATES & PLATTERS



Paper Dinnerware

BOWLS, PLATES & PLATTERS



A. SAVADAY® MOLDED FIBER DINNERWARE HUHTAMAKI

Designed to absorb more grease than anything else you can find. Molded fiber items are molded paper fiber formed into uniquely shaped products to assure strength and rigidity in foodservice operations. For baked items the pie plates provide the right size for all your needs. Plus, molded fiber items accept excess fats from baked goods, keeping pies flaky.

Bowl			
15301305	<i>21060</i>	45 oz., 9", White, Echo	500/cs.
Plates			
15300115	<i>10116</i>	9", White, Ace	500/cs.
15300120	<i>10117</i>	10", White, Acorn	500/cs.



B. NATURE FRIENDLY® DINNERWARE NATURE FRIENDLY PRODUCTS

Nature Friendly Products' 100% biodegradable and compostable tableware provides consumers with an eco-friendly alternative to traditional disposables. Made from sugar cane bagasse-based renewable resources, they are completely compostable within 50-100 days in home and commercial composting facilities. These products are superior in strength and performance. Non-toxic, hot/cold tolerant, oil and water resistant, microwave and freezer safe.

Barreled Soup Bowls & Lids			
C6932022	<i>L027</i>	Bowl, 14 oz.	600/cs.
C6933011	<i>L028</i>	Lid, Fits 14 oz.	500/cs.
C6932023	<i>L028</i>	Lid, Fits 14 oz.	600/cs.
Classic Bowls			
C6932002	<i>L003</i>	12 oz.	500/cs.
C6932003	<i>L003R</i>	12 oz., Retail Pack	500/cs.
C6932038	<i>L044</i>	13½ oz.	1000/cs.
C6932039	<i>L044R</i>	13½ oz., Retail Pack	24/25/cs.
Soup/Salad Bowls & Lids			
C6932021	<i>L026B</i>	Bowl, 12 oz.	500/cs.
C6932001	<i>L001B</i>	Bowl, 16 oz.	500/cs.
C6932014	<i>L014B</i>	Bowl, 32 oz.	500/cs.
C6932020	<i>L026A</i>	Lid, Fits 12 oz.	500/cs.
C6932000	<i>L001A</i>	Lid, Fits 16 oz.	500/cs.
C6932013	<i>L014A</i>	Lid, Fits 32 oz.	500/cs.
Square Bowl & Lid			
C6933006	<i>B021</i>	Bowl, 5½" x 5½"	450/cs.
C6933005	<i>B020</i>	Lid, Fits 5½" x 5½"	450/cs.
Classic Round Plates			
C6931010	<i>P011</i>	7"	1000/cs.
C6931011	<i>P011R</i>	7", Retail Pack	1000/cs.
C6931012	<i>P013</i>	9"	500/cs.
C6931013	<i>P013R</i>	9", Retail Pack	500/cs.
C6931003	<i>P005</i>	10"	500/cs.
C6931004	<i>P005R</i>	10", Retail Pack	500/cs.
C6931005	<i>P007</i>	10", 3-Compt.	500/cs.
C6931006	<i>P007R</i>	10", 3-Compt., Retail Pack	500/cs.
Ridged Edge Round Plates			
C6931000	<i>P001</i>	6"	1000/cs.
C6931001	<i>P002</i>	7"	1000/cs.
C6931002	<i>P003</i>	8"	1000/cs.
Oval Plates			
C6931008	<i>P009</i>	9" (7" x 5" Center)	1000/cs.
C6931020	<i>P020</i>	10"	500/cs.
C6931030	<i>P030</i>	12½"	500/cs.

Paper Dinnerware



A. PLACESETTER® PREFERRED™ DINNERWARE PACTIV

Molded fiber products are biodegradable and meet the ASTM D 6868 standards specifications for compostability. These products are made from sustainable, annually renewable materials that are environmentally friendly. Soak through resistant design resists grease, moisture and helps eliminate messy leaks. Natural white provides a brilliant, white exterior. Stackable.

Bowls

16206900	MC50008	8 oz.	1000/cs.
16206887	MC50012	12 oz.	1000/cs.
16206884	MC50016	16 oz.	500/cs.

Plates

16206879	MC50006	6"	1000/cs.
16206881	MC50010	10"	500/cs.

Oval Platter

16206888	MC50043	7½" x 10" x 1"	500/cs.
----------	---------	----------------	---------



B. PLACESETTER® PREFERRED™ EARTHCHOICE® DINNERWARE PACTIV

Made of a blend of Bagasse (Sugar Cane) and Bamboo, which are sustainable, annually renewable resources. ASTM D 6868 certified and compostable. Natural white exterior. Resist grease, moisture and help eliminate messy leaks.

Plates

16206897	MC500060001	6"	1000/cs.
16206899	MC500070001	6¾"	1000/cs.
16206895	YMC500090001	8¾"	500/cs.
16201577	YMC500110001	8¾", 3-Compt.	500/cs.
16203098	YMC500090002	9"	500/cs.
16206896	MC50044001	10", 3-Compt.	500/cs.

Oval Platter & Lid

16206898	YMC500470001	Platter, 9⅞" x 12½"	500/cs.
16202678	85914000000Y	Lid, Fits 9⅞" x 12½" Platter, Clear	300/cs.



C. PLACESETTER® SELECT HEAVY-DUTY PAPER DINNERWARE PACTIV

Heavyweight, tough, grease resistant coating. Microwaveable. Cut resistant. Bright White is outstanding for food presentation, merchandising and take-out. Go from the microwave to table with ease.

Bowl

16202516	PSP0515PUNPC	12 oz.	1000/cs.
----------	--------------	--------	----------

Plates

16202515	PSP0605PUNPCF	6", White, Fluted	1000/cs.
16202514	PSP0705PUNPC	7", White	1000/cs.
16202513	PSP0905PUNPC	8¾", White	500/cs.
16202512	PSP1005PUNPC	10¼", White	500/cs.



D. BARE® ECO-FORWARD® SYMPHONY™ PAPER PLATE SOLO®

Deep-well geometry is great for heavy, saucy foods like steak and potatoes. Made from 100% plant-based renewable resources. ASTM-D6868 certified. Compostable in a commercial compost facility. Cedar Grove compost facility accepted. Cost efficient/economical. Paperboard that is from a Forest Stewardship Council (FSC) or Sustainable Forestry Initiative (SFI) certified fiber source.

18201672	MP9J8001	9", Deep Well	500/cs.
----------	----------	---------------	---------

E. BARE® SUGARCANE SQUARE PLATE SOLO®

Made with at least 94% renewable resources. Compostable in a commercial compost facility.

18201929	10PSC2050	10"	500/cs.
----------	-----------	-----	---------

F. SYMPHONY™ PAPER DINNERWARE SOLO®

Clay-coated paper construction. Convenient and reliable.

18203537	HB12J8001	Bowl, 12 oz.	1000/cs.
18203889	HP9SJ8001	Plate, 9"	500/cs.



BOWLS, PLATES & PLATTERS

Plastic Dinnerware

PLASTIC DINNERWARE



A. ARISTOCRAT DINNERWARE

GENPAK

Perfect for applications where a little extra strength is required along with a stylish, contemporary finish. Aristocrat will work well with for anything from cafeteria settings to white tablecloth catered events. Crystal finish high impact plastic. Non-absorbent, cut resistant surface. Leak proof construction.

Bowls

34780240	70500	5 oz., White	1000/cs.
34780128	72400	24 oz., White	500/cs.

Plates & Lid

34780245	70600	Plate, 6", White	1000/cs.
34780250	70900	Plate, 9", White	500/cs.
34784060	71000	Plate, 10 1/4", White	500/cs.
34780225	71300	Plate, 10 1/4", 3-Compt., White	500/cs.
34781010	94010	Lid, Fits 10 1/4" Plates, Clear	200/cs.

B. SILHOUETTE® PLATES

GENPAK

Crystal finish high impact plastic dinnerware. Our Silhouette premium black plastic dinnerware is second to none in quality and appearance. With a variety of plastic plates, bowls and platters, it's easy to make a visual impact at any table setting with this elegant collection.

34780081	BLK09	9", Black	400/cs.
34780082	BLK10	10 1/4", Black	400/cs.
34781313	BLK13	10 1/4", 3-Compt., Black	400/cs.

C. FIRST CHOICE® DINNERWARE

HUHTAMAKI

Heavyweight plastic dinnerware with an upscale, high-shine that will enhance presentation.

Bowls

15300205	81205	5 oz., White	1000/cs.
15301412	81412	12 oz., Black	1000/cs.
15300113	81212	12 oz., White	1000/cs.
15301224	81224	24 oz., White	500/cs.
15300131	81232	32 oz., White	500/cs.

Plates

15300044	81406	6", Black	1000/cs.
15300310	81206	6", White	1000/cs.
15301407	81407	7", Black	1000/cs.
15301207	81207	7", White	1000/cs.
15300045	81409	9", Black	500/cs.
15300317	81209	9", White	500/cs.
15300176	81239	9", 3-Compt., White	500/cs.
15300319	81210	10 1/4", White	500/cs.
15300410	81410	10 1/4", Black	500/cs.
15301430	81430	10 1/4", 3-Compt., Black	500/cs.
15300323	81230	10 1/4", 3-Compt., White	500/cs.

Oval Platter

15301211	81211	11", White	500/cs.
-----------------	-------	------------	---------

D. POPULAR CHOICE® DINNERWARE

HUHTAMAKI

Lightweight plastic dinnerware that is an excellent value.

Bowl

15302205	82205	5 oz., White	1000/cs.
-----------------	-------	--------------	----------

Plates

15302206	82206	6", White	1000/cs.
15302209	82209	9", White	500/cs.
15302210	82210	10 1/4", 3-Compt., White	500/cs.
15302230	82230	10 3/4", 3-Compt., White	500/cs.

E. LIDS FOR PLASTIC PLATES

HUHTAMAKI

High profile dome lids.

15309020	89002	Fits 9"	150/cs.
15300073	89003	Fits 10 1/4"	200/cs.

BOWLS, PLATES & PLATTERS

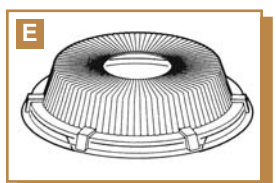

Plastic & Foam Dinnerware



A. NATURE FRIENDLY® PLA SALAD BOWLS/LIDS NATURE FRIENDLY PRODUCTS

100% biodegradable and compostable PLA containers and trays providing consumers with an eco-friendly alternative to traditional disposables. Made from corn-based PLA renewable resources, they are completely compostable within 50-100 days in commercial composting facilities. These products are superior in strength and performance, non-toxic, and clear in color.

C6938050	<i>SB120300</i>	Bowl, 10 oz.	1000/cs.
C6938051	<i>SB141500</i>	Bowl, 18 oz.	1000/cs.
C6938052	<i>SB1781000</i>	Bowl, 36 oz.	500/cs.
C6938056	<i>L12025</i>	Dome Lid, Fits 10 oz.	1000/cs.
C6938057	<i>L14128</i>	Dome Lid, Fits 18 oz.	1000/cs.
C6938058	<i>L17832</i>	Dome Lid, Fits 36 oz.	500/cs.



B. HEFTY® PLACESSETTER® IMPACT PLATE PACTIV

Heavy, cut resistant, high quality plastic tableware.

16200867	<i>TIBH009</i>	8 7/8", Black	400/cs.
-----------------	----------------	---------------	---------



C. SQUARE PLATE COMBO SABERT

Plastic plate/dome combo.

62200203	<i>C99330D100WM</i>	9" x 9" x 2", Black/Clear, 3-Compt.	100/cs.
-----------------	---------------------	-------------------------------------	---------



D. BIOPLASTIC DINNERWARE TRELIS EARTH®

100% biodegradable. Non-toxic. Microwaveable and steamer-safe.

Rectangular Bowl & Lid

C4780046	<i>WFW07</i>	Bowl, 16 oz.	300/cs.
C4780051	<i>WFW08</i>	Lid, Fits 16 oz.	300/cs.

Soup Bowl & Lid

C4780053	<i>WFW09</i>	Bowl, 20 oz.	300/cs.
C4780052	<i>WFW10</i>	Lid Fits 20 oz.	300/cs.

Deep Meal Plate & Cover

C4780048	<i>WFD31</i>	Plate, 10 1/4"	200/cs.
C4780047	<i>WFD32</i>	Cover, Fits 10 1/4"	200/cs.

E. CLASSICWARE® PLATES WNA COMET

The timeless elegance of Classicware® captures the look of fine china, adding a touch of class to any occasion. A heavyweight design makes this attractive dinnerware a durable alternative to china, paper, and foam products.

12202261	<i>CW6180</i>	6", Clear	180/cs.
12200754	<i>CW9180</i>	9", Clear	180/cs.



FOAM DINNERWARE

F. FOAM BOWLS DART

Dart insulated foam bowls keep hot servings hot and delicious, and cold servings cold and refreshing. Engineered with a rounded spoonable bottom, customers will enjoy every spoonful.

12502005	<i>5B20</i>	5 oz., White	1000/cs.
12502006	<i>6B12</i>	6 oz., White	1000/cs.
12502008	<i>8B20</i>	8 oz., White	1000/cs.
12500120	<i>10B20</i>	10 oz., White	1000/cs.
12502012	<i>12B32</i>	12 oz., White	1000/cs.





Foam Dinnerware

BOWLS, PLATES & PLATTERS



A. CELEBRITY DINNERWARE GENPAK

Foam insulated non-laminated dinnerware. Functional and stylish - the Celebrity line of foam dinnerware offers a wide range of sizes, all in an economical package. This is what you will find in our Celebrity series of dinnerware items. For commissary, food court and general food applications, choose our Celebrity line of foam dinnerware items. Our foam is cut resistant and non-absorbent to ensure a user friendly experience every time. We also offer a selection of lids for this line as well.

Bowls			
34784057	80500	5 oz., White	1000/cs.
34784058	82100	12 oz., White	1000/cs.
Plates			
34784050	80600	6", White	1000/cs.
34780700	80700	7", White	1000/cs.
34784052	80900	8 ⁷ / ₈ ", White	500/cs.
34784053	83900	8 ⁷ / ₈ ", 3-Compt., White	500/cs.
34784054	81000	10 ¹ / ₄ ", White	500/cs.
34784055	81300	10 ¹ / ₄ ", 3-Compt., White	500/cs.
Platter			
34780109	87900	7" x 9", White	500/cs.



B. CONCORDE® PLATE DART

Non-laminated foam dinnerware is strong enough to hold a full portion without bending. Superior insulating qualities make it perfect for both hot and cold foods.

12505283	9PWC	9", White	500/cs.
----------	------	-----------	---------

C. QUIET CLASSIC® PLATE DART

Laminated for extra strength and gloss. Strong enough to hold a full portion without bending. Superior insulating qualities make foam dinnerware perfect for both hot and cold foods.

12501701	9PWQ	9", White	500/cs.
----------	------	-----------	---------



D. ELITE DINNERWARE GENPAK

Cut resistant laminated foam dinnerware ensures your products will be served up with style and security every time.

Plates			
34780146	LAM09BK	8 ⁷ / ₈ ", Black	500/cs.
34780123	LAM09WH	8 ⁷ / ₈ ", White	500/cs.
34780118	LAM10WH	10 ¹ / ₄ ", White	500/cs.
34780285	LAM13BK	10 ¹ / ₄ ", 3-Compt., Black	500/cs.
34780117	LAM13WH	10 ¹ / ₄ ", 3-Compt., White	500/cs.
Platters			
34780277	LAM79BK	7" x 9", Black	500/cs.
34780145	LAM11BK	8 ¹ / ₂ " x 11 ¹ / ₂ ", Black	500/cs.



E. UTILITY BOWL & LID GENPAK

Cut resistant laminated foam dinnerware ensures your products will be served up with style and security every time.

34782402	LW024BK	Bowl, 24 oz., 8 ⁷ / ₈ ", Black	400/cs.
34782420	LW932	Lid, Fits 24/32 oz., Clear	200/cs.



F. HEFTY® FOAM PLATE PACTIV

Sturdy, disposable dinnerware is strong and soak proof.

16201159	D28100	8 ⁷ / ₈ ", 100 ct.	600/cs.
----------	--------	--	---------

Foam Dinnerware



A. PLACESETTER® DELUXE DINNERWARE PACTIV

Premium quality laminated foam construction. Non-absorbent, cut resistant surface. Excellent for wet foods and knife use.

Bowls

16202229	TK50004	4 oz./5 oz., Vanilla	1250/cs.
16202915	TK50030	30 oz., Vanilla	450/cs.

Plates

16200098	TK50006	6", Vanilla	1000/cs.
16200189	TK10006	6", White	1000/cs.
16200102	TK50009	9", Vanilla	500/cs.
16200208	TK10009	9", White	500/cs.
16200209	TK10011	9", 3-Compt., White	500/cs.
16202914	TK50010	10 1/4", Vanilla	540/cs.
16202912	TK10010	10 1/4", White	540/cs.
16202916	TK50044	10 1/4", 3-Compt., Vanilla	540/cs.
16202913	TK10044	10 1/4", 3-Compt., White	540/cs.

Platters

16200114	TK50045	7" x 9", Vanilla	1000/cs.
16202085	TK50043	8 1/2" x 11 1/2", Vanilla	500/cs.



B. PLACESETTER® PREMIER DINNERWARE PACTIV

Premium quality laminated foam dinnerware.

Plates

16202521	TXB0006	6", Black	1000/cs.
16202169	TXB0007	7", Black	900/cs.
16200010	TXB0007	7", Black	1000/cs.
16200009	TXB0009	9", Black	500/cs.
16201649	TXB0009	9", Black	500/cs.
16202917	TXB0010	10 1/4", Black	500/cs.
16202919	TXB0044	10 1/4", 3-Compt., Black	500/cs.

Platters

16202086	TXB0043	8 1/2" x 11 1/2", Black	500/cs.
16202675	TXB0047	10" x 12 1/2", Black	600/cs.



C. PLACESETTER® SATIN DINNERWARE PACTIV

Satin smooth foam, non-laminated surface.

Bowls

16202212	TH10004	4 oz./5 oz., White	1250/cs.
16202306	TH10012	12 oz., White	1000/cs.
16200177	TH10022	22 oz., White	500/cs.
16202907	TH10030	30 oz., White	450/cs.

Plates

16202631	TH10006	6", White	1000/cs.
16202159	TH10007	7", White	900/cs.
16200032	TH10009	8 7/8", White	500/cs.
16200127	TH10011	8 7/8", 3-Compt., White	500/cs.
16202906	TH10010	10 1/4", White	540/cs.
16202908	TH10044	10 1/4", 3-Compt., White	540/cs.



D. PLACESETTER® DOME LIDS PACTIV

Clear plastic dome lids for Placesetter® foam dinnerware.

16201738	C180006	Fits 6 oz. Bowl	504/cs.
16201741	C180009	Fits 9 oz. Bowl	126/cs.
16200546	C180010	Fits 10 oz. Bowl	250/cs.
16202228	C180012	Fits 12 oz. Bowl	504/cs.
16202064	C180030	Fits 30 oz. Bowl	504/cs.
16205910	85910	Fits 8 1/2" x 11 1/2" Platters, Clear	250/cs.



Foam Dinnerware



BOWLS, PLATES & PLATTERS



A. BASIX® DINNERWARE

SOLO®

Polystyrene unlined foam dinnerware. A lightweight and economical choice, the Basix® line helps make items like salads and appetizers more profitable. Count on a secure feel with very little bending.

Bowls

18704689	<i>FS5DBY0007</i>	5 oz., White	1000/cs.
18704687	<i>FS12BN0007</i>	12 oz., White	8/125/cs.

Plates

18704681	<i>FS6BPY0007</i>	6", White	1000/cs.
18704683	<i>FS9CY0007</i>	9", 3-Compt., White	500/cs.
18704697	<i>FS105Y0007</i>	10", White	500/cs.
18700004	<i>FS10CY0007</i>	10", 3-Compt., White	500/cs.

Oval Platter

18704631	<i>FS79PY0007</i>	9" x 7", White	500/cs.
-----------------	-------------------	----------------	---------



B. CENTER PIECE® FOAM DINNERWARE

SOLO®

Polystyrene laminated foam dinnerware. Topped with a single layer of laminate for cut resistance, Center Piece is an excellent everyday choice for strength.

Bowls

18700350	<i>RS35BY0007</i>	3½ oz., White	1000/cs.
18705266	<i>RS12BN0007</i>	12 oz., White	1000/cs.

Plates

18705304	<i>RS6BPY0019</i>	6", Champagne	1000/cs.
18705302	<i>RS6BPY0007</i>	6", White	1000/cs.
18705629	<i>RS7SPY0007</i>	7", White	1000/cs.
18208995	<i>RS9DPY0019</i>	9", Champagne	500/cs.
18705316	<i>RS9DPY0007</i>	9", White	500/cs.
18705322	<i>RS9CY0007</i>	9", 3-Compt. Plate, White	500/cs.
18705328	<i>RS105Y0007</i>	10", White	500/cs.
18705326	<i>RS10CY0019</i>	10", 3-Compt. Plate, Champagne	500/cs.

Oval Platter

18705312	<i>RS79PY0019</i>	9" x 7", Champagne	500/cs.
-----------------	-------------------	--------------------	---------



C. ELEGANCE FOAM PLATE

SOLO®

Sleek and black, Elegance provides an efficient alternative to permanentware. Its thick top laminate creates a strong cutting surface and helps support heavier foods like steak or an overstuffed baked potato.

18700176	<i>SR6BP0004</i>	6", Black	1000/cs.
-----------------	------------------	-----------	----------



D. SILENT SERVICE® FOAM BOWL

SOLO®

Polystyrene heavy laminated foam dinnerware. Provides an efficient alternative to permanentware. Its thick top laminate creates a strong cutting surface and helps support heavier foods like steak or an overstuffed baked potato.

18705620	<i>SS30BY0019</i>	30 oz., Champagne	500/cs.
-----------------	-------------------	-------------------	---------

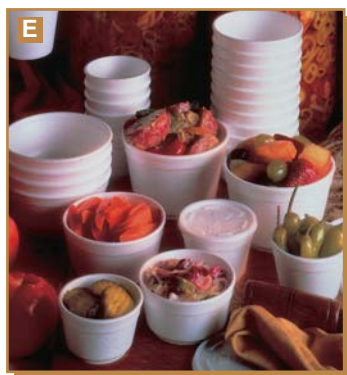

E. HANDI-KUP® UNIVERSAL HOT/COLD BOWLS

WINCUP

Smoothwall. Constructed of expandable polystyrene beads.

19400289	<i>B8ST</i>	8 oz., White	1000/cs.
19400642	<i>B10</i>	10 oz., White	1000/cs.

Paper Cold Drink Cups & Lids



PAPER COLD DRINK CUPS & LIDS

A. PRIME SOURCE® ENVY® PAPER COLD CUPS PRIME SOURCE®

Features a smooth wax finish inside and out for strength, rigidity, and beauty.

75002023	75002023	5 oz., Envy®	3000/cs.
75002024	75002024	7 oz., Envy®	2000/cs.
75002001	75002001	7 oz., Envy®	2500/cs.
75002025	75002025	8 oz., Envy®	2000/cs.
75002028	75002028	12 oz., Envy®	2000/cs.
75002004	75002004	12 oz., Envy®	2500/cs.
75002005	75002005	16 oz., Envy®	1000/cs.
75002006	75002006	20 oz., Envy®	1000/cs.
75002031	75002031	22 oz., Envy®	1000/cs.
75002007	75002007	24 oz., Envy®	1000/cs.
75002008	75002008	32 oz., Envy®	500/cs.



B. COLD CUP LID DOPACO

Translucent stock lid.

66372856	2856	Fits 22 oz., 12S/16R/16T	2400/cs.
----------	------	--------------------------	----------



C. DIXIE® WAX-TREATED PAPER COLD CUPS GEORGIA-PACIFIC

Perfect for everyday cold beverage use. Treated to help protect against soak-thru and improve stand up time.

15005922	45PATH	3 oz., Pathways™	2400/cs.
15005921	58PATH	5 oz., Pathways™	2400/cs.



D. DIXIE® WAX-TREATED PAPER COLD CUPS GEORGIA-PACIFIC

Wax coated cups are ideal cups for cold beverage service. Also great for the office break room. Bring a contemporary new look to your cold beverage service with cups featuring Pathways™, the latest product design from Dixie®. Based on nature's beauty, the Pathways™ cold beverage cup design will impress guests while performing beautifully. The WiseSize® product offering provides a packaging solution for efficiencies in your business. New smaller case sizes and a sleek, uniform poly design have been developed for an assortment of popular products. These smaller case sizes will result in a minimum of split cases and the individual UPC coded poly will make it easier to pull product for delivery.

15005924	45WS	3 oz. Flush Bottom, Pathways™, Wise Size™	1200/cs.
15005923	58WS	5 oz., Pathways™, Wise Size™	1200/cs.



E. PAPER COLD CUPS SOLO®

Double-sided poly (DSP) cups offer excellent print capabilities because of the shine of the poly coating. Printing is available in up to six colors. DSP cups are made with two-piece construction and tightly rolled rim for excellent performance.

18204805	RP16PJ8000	16 oz., Symphony™	1000/cs.
18208009	RSP21NJ8000	21 oz., Symphony™	1000/cs.
18203100	RSP22P00055	22 oz., Jazz®	1000/cs.



CUPS

Paper Cold & Hot Drink Cups & Lids



CUPS



A. SOLO® TREATED PAPER COLD CUPS SOLO®

Solo's treated paper cups offer superior rigidity as well as the flexibility of one lid that fits four sizes of cups (from 12 oz. squat to 22 oz.) for any cold beverage need. Treated paper cups also meet the ASTM standard for compostability and are made with at least 50% renewable resources.

Jazz®			
18200127	R5300055	5 oz.	3000/cs.
18200150	R6NN00055	6 oz.	2000/cs.
18200191	R7N00055	7 oz.	2000/cs.
18705214	R10NN00055	10 oz.	2000/cs.
18200335	R12N00055	12 oz.	2000/cs.
18200355	RW1600055	16 oz.	1000/cs.
Symphony™			
18201076	R53J8000	5 oz.	3000/cs.
18201078	R7NJ8000	7 oz.	2000/cs.
18201079	R8NJ8000	8 oz.	2000/cs.
18201081	R9NJ8000	9 oz.	2000/cs.
18201083	R12SNJ8000	12 oz. Squat	2000/cs.
18201082	R12NJ8000	12 oz.	2000/cs.
18201086	RW16J8000	16 oz.	1000/cs.

B. SOLO® CLEAR POLYSTYRENE FLAT LIDS SOLO®

With straw slot and identification buttons. Clear polystyrene plastic gives these lids excellent clarity and provides an enticing view of the cup's contents.

18200426	LC32B50099	Fits H32TN, RP32N, Clear	500/cs.
----------	------------	--------------------------	---------

PAPER HOT DRINK CUPS & LIDS

C. PRIME SOURCE® ENVY® PAPER HOT CUPS PRIME SOURCE®

Poly lined to preserve beverage quality and enhance cup strength.

75002040	75002040	6 oz.	1000/cs.
75002056	75002056	6 oz., Handled	1000/cs.
75002041	75002041	8 oz.	1000/cs.
75002057	75002057	8 oz., Handled	1000/cs.
75002042	75002042	10 oz.	1000/cs.
75002051	75002051	12 oz. Squat	1000/cs.
75002043	75002043	12 oz.	1000/cs.
75002044	75002044	16 oz.	1000/cs.

D. CAFE G™ GOURMET COFFEE CUPS DART

Cafe G™ stock printed foam cups keep beverages hot while remaining comfortable to the touch. The Cafe G™ coffee-themed design incorporates a subtle color coding system to help customers and employees identify the correct cup size.

12500089	12X16G	12 oz. Squat, Red Accents	1000/cs.
12500090	16X16G	16 oz., Green Accents	1000/cs.
12500091	20X16G	20 oz., Red Accents	500/cs.

E. DOME LID DOPACO

Features indicate buttons: cream, sugar, decaf. Strong construction for less cracking. Comfortable sip hole means less drips. Fits Dopaco White, Coffee Revolution and Swirl Design. Also fits Planet+ paper coffee cups. Polystyrene.

66371433	21433	Fits 10S/12/16/20/24 oz., Black	1000/cs.
----------	-------	---------------------------------	----------

F. DIXIE® PAPER HOT CUP GEORGIA-PACIFIC

Polylined paper hot cup. Designed to heat up your beverage sales. Perfect for samples and espresso drinks. Keeps liquid from soaking through. Provides upscale image at an economical cost for specialty hot beverages.

15001242	2342W	12 oz., Simply White	1000/cs.
----------	-------	----------------------	----------

Paper Hot Drink Cups & Lids



A. DIXIE® PAPER HOT CUPS GEORGIA-PACIFIC

Ideal for samples and espresso drinks. Provide an upscale image at an economical cost for specialty hot beverages. Poly-lined to protect against soak-thru. Durable sidewall strength. One standard lid fits three popular sizes.

15005940	<i>2338WS</i>	8 oz., Pathways™, Wise Size™	500/cs.
15005944	<i>2340PATH</i>	10 oz., Pathways™	1000/cs.
15005943	<i>2342PATH</i>	12 oz., Pathways™	1000/cs.



B. DIXIE® DOME LIDS GEORGIA-PACIFIC

Domed lid helps to prevent spills from sloshing. Sip through hole is easy to drink from while on the go. Condiment identifier easily identifies contents. Stacking feature makes it easier to carry two cups at a time.

15009539	<i>D9538</i>	Fits 8 oz., White	1000/cs.
15008010	<i>9538DX</i>	Fits 8 oz., White, Wise Size™	1000/cs.
15003540	<i>DL9540</i>	Fits 10 oz., White	1000/cs.
15002544	<i>D9542B</i>	Fits 10-16 & 12-20 oz., Black	1000/cs.
15000527	<i>D9542</i>	Fits 10-16 & 12-20 oz., White	500/cs.
15002542	<i>D9542</i>	Fits 10-16 & 12-20 oz., White	1000/cs.
15009050	<i>D9550</i>	Fits 20 & 24 oz., White	1000/cs.



C. INSULAIR® ECOSMART® TRIPLE WALL INSULATED PAPER CUPS GEORGIA-PACIFIC

Insulated paper cup made with post-consumer recycled fiber. Built-in sleeve eliminates the need for a separate cup sleeve. Solid paper construction promotes high-quality image. Keeps drinks hot 15 minutes longer than ordinary paper cups while remaining 20° cooler to the touch. Lids hug cup brim on inside and outside, forming a vacuum.

15000169	<i>AROREF0108C</i>	8 oz., Aroma, Wise Size™	500/cs.
15000172	<i>AROREF0112C</i>	12 oz., Aroma, Wise Size™	500/cs.



D. PERFECTOUGH® INSULATED CUPS GEORGIA-PACIFIC

Made from paper. Does not contain polystyrene foam. Insulated with a textured non-slip grip. Snap-on lids available.

15001355	<i>5338DX</i>	8 oz., Coffee Design	500/cs.
15006338	<i>5338CD</i>	8 oz., Coffee Design	1000/cs.
15002959	<i>92959BE</i>	10 oz., Bean Design	1000/cs.
15005311	<i>5310DX</i>	10 oz., Coffee Dreams	500/cs.
15001356	<i>5342DX</i>	12 oz., Coffee Design	500/cs.
15000575	<i>5342CD</i>	12 oz., Coffee Design	1000/cs.
15000052	<i>5356DX</i>	16 oz., Coffee Design	500/cs.
15000576	<i>5356CD</i>	16 oz., Coffee Design	1000/cs.
15001225	<i>5360CD</i>	20 oz., Coffee Design	500/cs.



E. ECOTAINER® HOT CUPS/LIDS INTERNATIONAL PAPER

Made with fully renewable resources; fiber from sustainably managed forests and Ingeo™ a plant-based material (PLA). Meets Sustainable Forestry Initiative® (SFI®) Chain-of-Custody certification standards. Meets ASTM Standards for Compostability. Certified by the Biodegradable Products Institute (BPI). Performance is comparable to standard single-use paper disposables. Made in the USA.

14700080	<i>SMRE8</i>	8 oz., Ecotainer®	1000/cs.
14703034	<i>SMME10COMPASS</i>	10 oz., Compass	1000/cs.
14700350	<i>SMRE12</i>	12 oz., Ecotainer®	1000/cs.
14700351	<i>SMRE16</i>	16 oz., Ecotainer®	1000/cs.
14700227	<i>LHRDS8</i>	Domed Sipper Lid Fits 8 oz., White	1000/cs.
14700300	<i>LHRDS16</i>	Domed Sipper Lid Fits 12, 16, 20, 24 oz., White	1200/cs.



CUPS

Paper Hot Drink Cups & Lids



A. ENVELLOP® LABELED HOT CUPS/LID PACTIV

Superior heat retention. Cups are cooler to the touch, yet keep contents hot. Exceptional sidewall strength eliminates the need for cup sleeve/double cupping and ensures optimal sturdiness and durability. Superior graphics print capability. Up to a nine color process which can give you magazine picture quality. Seamless, one-piece construction improves leak resistance.

16205600	<i>YHCL16ENV</i>	16 oz., Savor™	420/cs.
16205602	<i>YHCL20ENV</i>	20 oz., Savor™	480/cs.
16205601	<i>YHCL24ENV</i>	24 oz., Savor™	360/cs.
16202167	<i>LHC16E</i>	Dome Lid w/Lock Back Tab Fits 12-24 oz., Ebony	900/cs.



B. BARE® ECO-FORWARD® POST CONSUMER FIBER (PCF) PAPER HOT CUPS SOLO®

Supporting the use of post-consumer recycled content is a key tenet of Solo's Eco-Forward® platform. PCF hot cups contain paper which has completed the product life cycle as a consumer item and would otherwise end up in a landfill, such as paper collected from offices and school recycling programs. This post-consumer recycled fiber is incorporated into the cup reducing the use of virgin materials and the impact on valuable natural resources.

18200989	<i>374RCJ8484</i>	4 oz., Bare™	1000/cs.
18200991	<i>378RCJ8484</i>	8 oz., Bare™	1000/cs.
18200993	<i>410RCJ8484</i>	10 oz. Squat, Bare™	1000/cs.
18200992	<i>370RCJ8484</i>	10 oz., Bare™	1000/cs.
18200994	<i>412RCJ8484</i>	12 oz., Bare™	1000/cs.
18200995	<i>316RCJ8484</i>	16 oz., Bare™	1000/cs.
18200997	<i>420RCJ8484</i>	20 oz., Bare™	600/cs.



C. BARE® PLA HOT CUPS SOLO®

PLA hot cups are fully compostable, degrading through biological decomposition. Paper cup lined in PLA (a plant-based resin). Made from 100% renewable resources. Compostable in a commercial compost facility.

18202572	<i>370PLAJ7234</i>	10 oz., Bloom	1000/cs.
18202574	<i>316PLAJ7234</i>	16 oz., Bloom	1000/cs.



D. DUO SHIELD® INSULATED PAPER HOT CUPS SOLO®

Duo Shield® insulated paper hot cups provide air pocket insulation to keep beverages hot and hands at a comfortable temperature. This dual layer product eliminates the need to add a sleeve or double cup hot beverages.

18208012	<i>IC12J8000</i>	12 oz., Symphony™	600/cs.
18201298	<i>IC12J7534</i>	12 oz., Tuscan Café	600/cs.
18201297	<i>IC16J7534</i>	16 oz., Tuscan Café	525/cs.
18201296	<i>IC20J7534</i>	20 oz., Tuscan Café	350/cs.

E. HOT DRINK CUPS SOLO®

Poly lined paper hot drink cups.

18208102	<i>376T00055</i>	6 oz., Jazz®	1000/cs.
18202417	<i>378SMJ8000</i>	8 oz., Symphony™	20/50/cs.
18208104	<i>378HJZ00055</i>	8 oz. w/Handle, Jazz®	20/50/cs.
18208105	<i>378HSMJ8000</i>	8 oz. w/Handle, Symphony™	20/50/cs.
18202352	<i>412MSN0029</i>	12 oz., Mistique®	20/50/cs.
18207234	<i>412PLNJ7234</i>	12 oz., Bare™	1000/cs.
18202392	<i>412SIN0041</i>	12 oz., Bistro™	1000/cs.
18203416	<i>424RCNJ8484</i>	24 oz., Bare™	20/50/cs.



Paper Hot Drink Cups & Lids



A. SOLO® SINGLE SIDED POLY (SSP) PAPER HOT CUPS SOLO®

Solo® single sided poly hot cups are great for serving hot beverages like coffee, tea or cocoa. The cups are lined with polyethylene which acts as a moisture barrier to keep liquid inside the cup and prevent leaking. Feature a rolled rim to ensure a secure lid fit and are available in a variety of prints to complement any operation.

Bistro™

18200902	374SI0041	4 oz.	1000/cs.
18200897	378SI0041	8 oz.	1000/cs.
18200895	370SI0041	10 oz.	1000/cs.
18200894	412SI0041	12 oz.	1000/cs.
18200893	316SI0041	16 oz.	1000/cs.
18200892	420SI0041	20 oz.	600/cs.

Jazz®

18208106	378JZ00055	8 oz.	20/50/cs.
18208097	370JZ00055	10 oz.	20/50/cs.
18208094	316JZ00055	16 oz.	1000/cs.

Mistique®

18206423	378MS0029	8 oz.	1000/cs.
18206422	412MS0029	12 oz.	1000/cs.
18206421	316MS0029	16 oz.	1000/cs.
18206420	420MS0029	20 oz.	600/cs.

Symphony™

18202369	412SMJ8000	12 oz.	20/50/cs.
18208096	316SMJ8000	16 oz.	1000/cs.

White

18208940	374W2050	4 oz.	1000/cs.
18200027	376W2050	6 oz.	20/50/cs.
18207962	378W2050	8 oz.	1000/cs.
18207959	378HW2050	8 oz. w/Handle	1000/cs.
18208227	410W2050	10 oz. Squat	20/50/cs.
18207942	370W2050	10 oz.	1000/cs.
18203521	PS51202050	12 oz. Squat	1000/cs.
18202311	412WN2050	12 oz., White	1000/cs.
18207907	316W2050	16 oz.	1000/cs.
18204200	420W2050	20 oz.	600/cs.



B. HOT CUP LIDS SOLO®

Liftback and lock tab lid. Fits single sided poly paper hot cups.

18205314	LB308100007	Fits 378, White	10/100/cs.
18205312	LB316100007	Fits 410, White	10/100/cs.

C. TRAVELER PLUS® RECLOSABLE DOME HOT CUP LIDS SOLO®

Traveler Plus® dome lids allow extra space for froth or whipped cream for gourmet hot beverages. These lids are also reclosable for secure transportation.

18200309	TPLUS0001	Fits 10 oz. Squat, 12, 16, 20, 24 oz., White	1000/cs.
----------	-----------	--	----------



D. TRAVELER® DOME HOT CUP LIDS SOLO®

Traveler® dome lids allow extra space for froth or whipped cream for gourmet hot beverages. The inner ring reduces pop-off incidents, providing a more secure lid fit and reducing dribble at the rim and cup seam.

18206011	TL38R10007	Fits 8 oz., 378, IC8, White	1000/cs.
18201301	TLP200007	Fits 10 oz. Squat/12/16/20 oz., IC20, White	350/cs.
18206013	TL31R20007	Fits 10 oz., White	1000/cs.
18206016	TLN31600013	Fits 10 oz. Squat - 24 oz. Cups, Brown	1000/cs.
18206006	TLB3160004	Fits 10-24 oz., 316, 412, 420, 424, Black	1000/cs.
18206005	TLP3160007	Fits 12, 16, 20 oz., 316, 412, 420, 424, White	1000/cs.



CUPS

Hot Cup Sleeves/Plastic Cups & Lids



CUPS



HOT CUP SLEEVES

A. HOT CUP SLEEVE

DOPACO

Pre-assembled plain brown cup sleeve that goes with any cup design.

66379511 9511 Fits 12-20 oz., Kraft 1000/cs.



B. CUP BUDDY®

INTERNATIONAL PAPER

Fits 10 to 24 oz. cups. Locks in place with heat-activated adhesive. Easy to grip texture. Compostable and recyclable.

14704002 RCDK20 Cup Buddy® 1200/cs.



PLASTIC CUPS & LIDS

C. PRIME SOURCE® PLASTIC TUMBLER/LID

PRIME SOURCE®

Premium clear plastic tumbler.

76008008 76008008 9 oz., Clear 1000/cs.

76008009 76008009 Lid Fits 9 oz. 1000/cs.



D. CONEX CLASSIC® COLD CUP/LID

DART

Conex Classic® premium plastic cups will enhance your visibility with their crystal clarity and print capability.

12505500 16CT 16 oz., Clear 1000/cs.

12501023 L24C Straw Slotted Lid Fits 16CT, 20CT, 24C 1000/cs.

E. CONEX CLEARPRO® POLYPROPYLENE CUPS

DART

Made of polypropylene, ClearPro® cups are crack-resistant while maintaining excellent clarity. The rolled rim provides comfortable drinking while providing a secure lid fit.

12501950 16P 16 oz. 1000/cs.

12501952 20P 20 oz. 600/cs.



F. CONEX® COLD CUPS/LID

DART

Translucent plastic cold drink cups with smooth rolled rims. Sidewall rings add strength and provide a no-slip gripping surface.

12500204 5N25 5 oz., Translucent 2500/cs.

12505163 9N25 9 oz., Translucent 2500/cs.

12505170 12SN 12 oz., Translucent 1000/cs.

12500014 16K 16 oz., Translucent 1000/cs.



G. GREENWARE® COLD DRINK CUPS

FABRI-KAL

Thermoformed out of NatureWorks™ Poly Lactic Acid (PLA), a polymer derived entirely from natural corn starches. PLA is 100% renewable through annual corn harvests and fully compostable in municipal and industrial facilities. Crystal clear, slanted rib design. Printable up to eight colors. Smooth rolled rim.

13301851 GC12S 12/14 oz. Squat, Plain, Lid: LGC12/20 1000/cs.

13301852 GC16S 16/18 oz. Squat, Clear, Lid: LGC16/24 1000/cs.

13301850 GC20 20 oz., Clear, Lid: LGC12/20 20/50/cs.

13301848 LGC1624 X-Slot Lid Fits GC16S, GC24, Clear 1000/cs.



H. DIXIE® CLEAR CUPS

GEORGIA-PACIFIC

WiseSize™ PETE plastic cups.

15002219 CP10DX 10 oz., Clear 500/cs.

15002221 CP12DX 12 oz., Clear 500/cs.

15002222 CP16DX 16 oz., Clear 500/cs.



Plastic Cups & Lids



A. DIXIE® PETE® CLEAR CUPS/LIDS GEORGIA-PACIFIC

Shatter resistant, crystal clear cups are strong, durable and highly flexible. Large smooth area for custom printing. Use with Lids CL1420, DL1420, DF1420.

15008877	CP9A	9 oz. Squat, Clear	1000/cs.
15002214	CP1214	12/14 oz., Clear	1000/cs.

Dome Lid

Tight fit plastic dome lid fits multiple sizes. Prevents spillage. Creates a showcase package. Save storage and space.

15001420	DF1420	Dome Lid w/o Hole Fits 9, 14 & 20 oz.	20/50/cs.
-----------------	--------	---------------------------------------	-----------

Straw Slotted Lids

Tight fit. Straw slotted. Prevents spillage. Stackable. Saves storage and space.

15001900	CL1420	Fits 9, 14 & 20 oz., Clear, PETE	20/50/cs.
15001622	CL1624	Fits 16 & 24 oz., Clear, PETE	1000/cs.



B. LIDS GEORGIA-PACIFIC

Long skirt. Snaps on easy. Raised straw slot. Prevent leakage. Selector buttons. Easy to identify the drink inside.

15009141	914LSRD	Fits 12, 16, 21 oz.	1200/cs.
15001170	928LSRD	Fits 32 oz., Long Sleeve	600/cs.



C. KID'S CUP COMBO HUHTAMAKI

Includes cup, lid, and clear flexible whistle straw. Injection-molded plastic cup.

15306273	06273	12 oz., Yellow Blades & Headphones Design	250/cs.
-----------------	-------	---	---------



D. NATURE FRIENDLY® PLA COLD CUPS/LID NATURE FRIENDLY PRODUCTS

Nature Friendly Products' 100% biodegradable and compostable PLA cold cups, lids and straws provide consumers with an eco-friendly alternative to traditional disposables. Made from corn-based PLA renewable resources, these products are completely compostable within 50-100 days in home and commercial composting facilities, and are non-toxic and superior in strength and performance.

C6938003	PLA98540	16 oz.	1000/cs.
C6930003	GC16SR	16/18 oz., Retail Pack	1000/cs.
C6938004	PLA98650	22 oz.	1000/cs.
C6938012	L988K	Flat Lid Fits 16/22 oz. Cups	1000/cs.

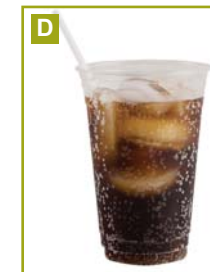

E. EARTHCHOICE® PLA CUPS/LIDS PACTIV

Made with Ingeo™ - 100% annually renewable material made from plants. Exceptional clarity - makes drink identification easy and presents contents in an upscale way. Exceptional strength - durable, made tough for everyday demand. Custom printing available - communicates brand image. Optimized cube utilization packs - efficient case packs for shipping. Snap lock lids. ASTM D 6400 certified and compostable.

16202475	YPLA9C	9 oz., Clear	975/cs.
16202474	YPLA1412C	12-14 oz., Clear	680/cs.
16202473	YPLA160C	16 oz., Clear	696/cs.
16202472	YPLA21C	20 oz., Clear	600/cs.
16202469	YPLA24C	24 oz., Clear	580/cs.
16202476	YLPADL24C	Dome Lid Fits 12, 14, 16, 20, 24 oz.	900/cs.
16202042	YLPLA24C	Straw Slot Lid Fits 12, 14, 16, 20, 24 oz.	915/cs.



F. PET CLEAR CUPS PACTIV

PET clear cup.

16202092	YP160C	16-18 oz.	700/cs.
-----------------	--------	-----------	---------



G. PLASTIC DRINK CUPS PACTIV

Printable clear drink cups. Rolled rims ensure enhanced drinking comfort and a secure closure using the snap fit lids. Sturdy shatter and crack resistant PET material adds to overall strength.

16200679	PCPC12	12 oz., Clear	500/cs.
-----------------	--------	---------------	---------



CUPS

Plastic Cups & Lids



CUPS

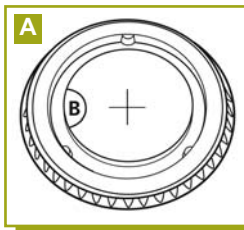

A. CUP LIDS			PACTIV
Clear PET lids with straw slot.			
16202121	YLP20C	Size A	1020/cs.
16202113	YLP24C	Size B	1020/cs.



B. DOME LID			PACTIV
Clear plastic dome lid.			
16201178	PLDL662	Fits PCPC20	1000/cs.



C. LID			PACTIV
Clear dome lid.			
16202098	PDL20CNH	Fits 12, 14, 20 oz., w/No Hole	900/cs.



D. BARE® ECO-FORWARD® RECYCLED CONTENT PLASTIC COLD CUPS			SOLO®
Supporting the use of post-consumer recycled content is a key tenet of Solo's Eco-Forward® platform. Requiring post-consumer recycled materials, instead of post industrial sources, encourages consumer recycling and creates market demand for consumer recycled materials. Solo's Eco-Forward® offering includes products made with recycled PET water bottles and containers and paper collected from offices and school recycling programs.			
18201013	RTP16J9036	16 oz., Bloom	1000/cs.
18201001	RTN20J9036	20 oz., Bloom	1000/cs.
18200998	RTD24J9036	24 oz., Bloom	600/cs.



E. COLD CUPS			SOLO®
Plastic party cold cups.			
18200873	P16RLR	16 oz., Red	1000/cs.



F. GALAXY® TRANSLUCENT PLASTIC CUPS			SOLO®
Galaxy® polystyrene cold cups are an economical, convenient option for snack bars and recreation foodservice establishments. Great for a variety of chilled beverages like beer, soft drinks, lemonade, and iced tea, they feature double sidewall ridges for strength and performance that can be counted on. Economical, lower-cost option for plastic cups. Double sidewall ridges give added strength and durability and helps prevent spills. Variety of snap-tight lid options are ideal for every type of beverage application. Printed and unprinted versions allow versatility.			
18202150	Y5JJ	5 oz.	2000/cs.
18202151	Y7JJ	7 oz.	2000/cs.
18202108	Y7RH0100	7 oz.	2000/cs.
18202159	Y9JJ0100	9 oz.	1500/cs.
18202153	Y10JJ0100	10 oz.	1500/cs.
18202154	Y12JJ	12 oz.	1000/cs.
18202155	Y14JJ	14 oz.	1000/cs.
18202156	Y16JJ0100	16 oz.	1000/cs.
18200616	Y16RL0100	16 oz., Beer Cup	1000/cs.
18206807	Y16SJ	16-18 oz. Squat	1000/cs.
18202090	Y20JJ	20 oz.	800/cs.



G. GO CUP®			SOLO®
Give your customers the convenience of the tapered bottom cup. The tapered bottom means the Go Cup® fits in a standard car cup holder. A tight fit makes a great seal. The lids are tight fitting to prevent spills during carry-out and travel.			
18708205	CG44W00007	44 oz., White	240/cs.



H. KID CUP COMBO			SOLO®
Combo pack includes cups, lids and flexible straws. Customized design. Embossed snap-tight, spill-resistant lids. Strong, multi-layer construction.			
18207374	CC12CJ5145	12-14 oz., Jungle	250/cs.

Plastic Cups & Lids



A. LUMINA® TRANSLUCENT PLASTIC COLD CUPS SOLO®

These cups are an economical alternative to premium clear cups. They're printable in all sizes, and your options are plentiful from 7 to 32 oz. Polystyrene.

18700021 CDE1200090 12-14 oz., Translucent 1000/cs.



B. SOLO® CRYSTAL LINE PLASTIC COLD CUPS SOLO®

Treat your customers to the sparkle of fine crystal - without all the trouble. These refined, clear polystyrene cups are sure to impress. Polystyrene.

18701608 FC95X00090 9 oz. Squat, Clear 500/cs.



C. SOLO® PARTY PLASTIC DRINK CUPS SOLO®

Solo® Party Cups are perfect for any occasion. Try the convenient small refill sizes for water cup applications and the larger sizes for sodas, juices and mixed drinks. With multi-layer construction for rigidity, and a wide variety of design and color options, these durable, high-quality disposables are always impressive.

18204610 P35A 3½ oz., Translucent 2500/cs.

18204657 PS12R 12-14 oz., Red 1000/cs.

D. ULTRA CLEAR™ PETE PLASTIC COLD CUPS SOLO®

Showcase colorful or signature beverages with the best of the best. Solo® Ultra Clear™ Cups have superb clarity and crack resistance for a high-end look and feel. Easily recyclable where available, they also feature excellent taste and odor integrity. When you need to impress, the difference is clear.

18209121 TP70090 7 oz., Clear 1000/cs.

18203165 TP9R0090 9 oz. Squat, Clear 1000/cs.

18205808 TP90090 9 oz., Clear 1000/cs.

18205812 TP9C0090 9 oz. Tall, Clear 1000/cs.

18200010 TP100090 10 oz., Clear 1000/cs.

18205820 TP220090 12 oz., Clear 1000/cs.

18205824 TP120090 12-14 oz., Clear 1000/cs.

18205828 TP160090 16-18 oz., Clear 1000/cs.

18205832 TN200090 20 oz., Clear 1000/cs.

18202400 TD240090 24 oz., Clear 600/cs.

18203200 TD320090 32 oz., Clear 300/cs.



E. DOME LIDS SOLO®

Plastic dome lids with hole.

18201283 DL6620090 Fits TP9, TP12, TN20, PS12, Clear 1000/cs.

18209226 DLR160090 Fits R12SN, RN16, RNP16, RNP21, RP12S, RP16, RS16N, RS22, RSP16, RSP21, RSP22, R12S, RSP20, RW16, Clear 1000/cs.

18209214 DLR240090 Fits RP24, R24, VS506, VS606, Clear 1000/cs.

18209205 DLR6260090 Fits TP16, TD24, TD26, RTP16, RTD26, PX12, PX14, PX16, PX18, PX20, PX24, Y16SJ, Y24JJ, P16RL, D24, DSS5, SD12 1000/cs.

18706084 LD28CH0090 Fits CD28T, CDL28T, CDE28T, CG32W, XG32R, RP28N, Clear 500/cs.

18200371 LDA20C0090 Fits CD95, CD12, CD20, CDL95, CDL12, CDL20, CDE12, R20, Clear 1000/cs.



F. DOME LIDS SOLO®

Improved stacking, nesting, and case cube. Premium, redesigned dome lid. The perfect fit for our cups and sundae dishes, these lids feature exceptional clarity to showcase your smoothies, gourmet frozen beverages, sundaes and so much more. Fits TP9, TP12, TR16, TN20, RTP9, RTP12, RTN20, PS12, N20, SD5, SD8, TS5.

18206667 DLR6620090 w/Hole, Clear 10/100/cs.

18206668 DNR6620090 No Hole, Clear 1000/cs.



CUPS

Plastic Cups & Lids



CUPS

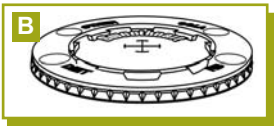

A. SOLO® FLAT COLD CUP LIDS SOLO®

Clear PETE plastic lids provide excellent clarity and an enticing view of the cup's contents.

Identification Straw Slot Lid

18208838 635NS Fits 32 oz. Double Poly & Big Drink Cups, Clear 600/cs.

No Slot Lid

18208860 626TP0090 Fits TP16, TD24, Y16SJ, Y24JJ, PS16, D24, Clear 1000/cs.

18208900 662TP0090 Fits TP9, TP12, TN20, PS12, N20, Clear, 1000/cs.

18203718 M600P0090 Fits 600 TP, Clear 1000/cs.

Straw Slot Lid

18208896 662TS0090 Fits TP9, TP12, TN20, PS12, TN20, Clear 1000/cs.

18200099 600TS0090 Fits TP10, Y9LT, Y10JJ, PS10, Clear 2500/cs.

18208852 626TS0090 Fits TP16, Y16SJ, Y24JJ, PS16, TD24, Clear 1000/cs.

18203086 639TR Fits TD32, Clear 500/cs.

18208840 640TS0090 Fits TP22, Y12JJ, M22, Clear 2500/cs.

18208848 695TS Fits Y14JJ, Clear 1000/cs.

B. SOLO® POLYSTYRENE FLAT LIDS SOLO®

With straw slot and identification buttons. Translucent polystyrene plastic lids provide

snap-tight seals for leak-resistant performance for all beverage lid needs.

18200337 L12BLN0099 Fits CD10, CDE10, CDL101, R12N, 2000/cs.
RP12N, Translucent

18703407 L14BLN00100 Fits CDE12T, CDL12T, Translucent 2000/cs.

18200388 L1624B0100 Fits R24, RP24, S16, Translucent 2000/cs.

18200357 L16BL0100 Fits R12SN, RP12S, RP16, RS16N, RW16, 2000/cs.
RS22N, RSP16N, RSP20, RSP21N,
RSP22N, Translucent

18200361 L20BL0100 Fits CD12, CD95, CDE12, CDS12, CV18WX, 2000/cs.
CVP18X, CDL95, CDL12, CD20, CDL20, CDA12,
CDA20, R20, VP18, GA20, Translucent

18700338 L28BN0100 Fits CG32C, CG32W, CDL28T, RP28N, Translucent 960/cs.

18200425 L32BN0100 Fits H32TN, RP32N, Translucent 960/cs.

18700469 L44BN0100 Fits CG44C, CG44W, Translucent 960/cs.

18200297 L9N0100 Fits CD7, CDL7, CDE7, R9N, Translucent 2000/cs.

18200362 LC20B10091 Fits CD95, CD12, CD20, CDL95, CDL12, CDL20, 1000/cs.
CDE12, R20, Clear

18700017 LC211600091 Fits CD16, CD21N, CD24T, CDL16, CDL21, 1000/cs.
CDL24T, CDE16, CDE21N, Clear

18700644 LX33BN0100 Fits X33N, Translucent 960/cs.

18200359 L16R0100 Fits R12SN, RP12S, RP16, RS16N, RS22N, 1000/cs.
RSP16N, RSP20, RSP21N, RSP22N,
RW16, Translucent

18703401 L6NN0100 Fits R6NN, Translucent 2000/cs.

C. STRAW SLOT LID SOLO®

Straw slot lid.

18208872 668TS Fits 112MD, 168MD, 221MD, Clear 1000/cs.

D. COMETWARE™ RIGID TUMBLERS WNA COMET

Rigid plastic tumblers.

12200060 T5S 5 oz. Squat, Clear 20/50/cs.

12200070 T7T 7 oz. Tall, Clear 500/cs.

12200075 T8T 8 oz. Tall, Clear 500/cs.

12200080 T9S 9 oz. Squat, Clear 500/cs.

12200085 T10 10 oz. Tall, Clear 500/cs.

12200090 T12 12 oz. Tall, Clear 500/cs.

12200100 T16 16 oz. Tall, Clear 500/cs.

Foam Cups & Lids



FOAM CUPS & LIDS

A. PRIME SOURCE® ENVY® FOAM CUPS

PRIME SOURCE®

Beautifully printed, thin-walled, super insulating cups are excellent for hot or cold drinks.

75002802	75002802	12 oz., Envy®	1000/cs.
75002804	75002804	16 oz., Envy®	750/cs.
75002806	75002806	20 oz., Envy®	750/cs.



B. DRINK CUPS/LIDS

DART

Foam cups keep beverages at their proper serving temperature on the inside and keep hands comfortable on the outside. Hot or cold, insulated foam delivers drinks the way they were meant to be.

12501014	4J4	4 oz., White	1000/cs.
12500212	6J6	6 oz., White	1000/cs.
12500220	8J8	8 oz., White	1000/cs.
12500124	10J10	10 oz., White	1000/cs.
12501212	12J16	12 oz. Medium, White	1000/cs.
12500136	12J12	12 oz. Tall, White	1000/cs.
12500148	14J16	14 oz. Medium, White	1000/cs.
12501214	14J12	14 oz. Tall, White	1000/cs.
12500152	16J16	16 oz., White	1000/cs.
12500172	20J16	20 oz., White	500/cs.
12502416	24J16	24 oz., White	500/cs.
12500180	24J24	24 oz., White	500/cs.
12500196	32TJ32	32 oz., White	500/cs.
12505080	44TJ32	44 oz., White	300/cs.
12500176	20RL	Vented Lid Fits 20 Series Cups, White	500/cs.
12500194	32RL	Vented Lid Fits 32TJ32, 12B32, White	500/cs.



C. HORIZON® DRINK CUPS

DART

The Horizon® design adds a touch of color to any beverage service, while providing an economical alternative to custom print. Suited for hot or cold beverages. Color-coded by size for easy identification.

12500019	12J12H	12 oz.	1000/cs.
12500023	12J16H	12 oz.	1000/cs.
12501610	16J16H	16 oz.	1000/cs.
12500053	20J16H	20 oz.	500/cs.



D. IMPULSE® DRINK CUPS

DART

Dual use foam cups for both hot and cold drinks. Color coded design with capacity printed on each size.

12500232	12J16E	12 oz.	1000/cs.
12500001	16J16E	16 oz.	1000/cs.
12500054	20J16E	20 oz.	500/cs.

E. LIFT N' LOCK™ LIDS

DART

Plastic lid for foam cups and containers. 100 lids per bag.

12500308	8FTL	Fits 6J8, 8J8, White	1000/cs.
12500310	10FTL	Fits 10J10, White	1000/cs.
12500312	12FTL	Fits 12 oz., White	1000/cs.
12500311	12FTLS	Fits 12J12, Translucent	1000/cs.
12500316	16FTL	Fits 16 Series, White	1000/cs.
12500406	16FTLS	Fits 16 Series Cups, w/Straw Slot, Translucent	1000/cs.



CUPS



Foam Cups & Lids



A. SIP THRU® LIDS

DART

Plastic lid for Dart foam cups and containers. 100 lids per bag.

12507108	8UL	Fits 6J8, 8J8, 10FJ8, White	1000/cs.
12500127	10UL	Fits 10 Series Cups, White	1000/cs.
12500144	12UL	Fits 12J12, 14J12, 14FJ12, White	1000/cs.
12507116	16UL	Fits 12J16, 14J16, 16J16, 20J16, 24J16, White	1000/cs.



B. VENTED LIDS

DART

Plastic lid for foam cups and containers. 100 lids per bag.

12500208	6JL	Fits 6J6, 6J6-5, White	1000/cs.
12500216	8JL	Fits 8J8, 6J8, White	1000/cs.
12500409	10JL	Fits 10 Series, White	1000/cs.
12500132	12JL	Fits 12 Series, White	1000/cs.



C. VENTED LIDS

DART

Plastic lid for foam cups and containers. 100 lids per bag. Translucent.

12505050	4JL	Fits 4J4	1000/cs.
12507117	16JL	Fits 12J16, 14J16	1000/cs.
12500170	20JL	Fits 8SJ20, 12SJ20	1000/cs.
12500184	32JL	Fits 32TJ32, 12B32	500/cs.
12500200	48JL	Fits 24MJ48, 32MJ48	500/cs.



D. CAPPUCCINO LIDS

DART

Plastic cappuccino lids. 100 lids per bag.

12501375	16ELBLK	Fits 16 oz., Black	1000/cs.
12500161	16EL	Fits 16 oz., White	1000/cs.

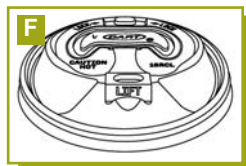

E. DOME LID

DART

Clear high dome lid. 50 lids per bag.

12507222	20HDL	Fits 20 oz.	1000/cs.
----------	-------	-------------	----------



F. OPTIMA™ RECLOSABLE LID

DART

For use with any 16 lid series cup.

12507114	16RCLBLK	Fits 16 oz., Black	1000/cs.
----------	----------	--------------------	----------

G. STRAW SLOT LIDS

DART

Translucent plastic lid for foam cups and containers. 100 lids per bag.

12500128	10SL	10 Series Lid	1000/cs.
12500140	12SL	12 Series Lid	1000/cs.
12500158	16SL	16 Series Lid	1000/cs.
12502412	20SL	20 Series Lid	1000/cs.
12500122	24SL05	24 Series Lid	500/cs.
12500192	32SL	32 Series Lid	500/cs.



H. TROPHY® DUAL TEMPERATURE INSULATED CUPS/LIDS

SOLO®

Trophy® dual temperature insulated cups offer a single-cup solution for hot and cold beverages, a common lid fit for the five most popular cup sizes and a smaller case cube to minimize warehouse storage space. These efficient cups are durable and feature full print graphics to showcase operator brand identity.

Cups

18700978	X800055	8 oz., Jazz®	1000/cs.
18707305	X1200055	12 oz., Jazz®	1000/cs.
18200860	X120029	12 oz., Mistique®	1000/cs.
18201124	X12J8002	12 oz., Symphony™	10/100/cs.
18700668	X16N00055	16 oz., Jazz®	750/cs.
18200861	X16N0029	16 oz., Mistique®	750/cs.
18201127	X16NJ8002	16 oz., Symphony™	750/cs.
18200883	X20N0041	20 oz., Bistro™	750/cs.
18700742	X20N0055	20 oz., Jazz®	750/cs.

CUPS

Foam Cups & Lids



A. TROPHY® DUAL TEMPERATURE INSULATED CUPS/LIDS (CONT.)

SOLO®

Dome Sip Thru Lids

18201324	LGXBK20004	Fits 12, 16, 20 & 24 oz. Cups, Black	1500/cs.
18201328	LGXW20007	Fits 12, 16, 20 & 24 oz. Cups, White	1500/cs.

Polystyrene Liftback & Lock Lids

Liftback and lock lid for paper and Trophy® hot cups. Fits snug. Allows stacking. Tab re-seals, prevents splashes.

18704512	DTL51200007	Fits P512, White	2000/cs.
18702516	DTL51600007	Fits PS510, PS512, P516, P520, P524, White	2000/cs.

Solo® polystyrene plastic Lift and Lock Tab hot/cold cup lids with straw slot and identification buttons. Translucent polystyrene plastic lids provide snap-tight seals for leak-resistant performance for all beverage lid needs. Translucent.

18701234 LX2SBR00100 Fits X12, X16N, X20N, X22N, XN246 2000/cs.
Solo's economy lid offering - a flat lid featuring a scored tab that is pushed back and locked into place for use. One lid fits the 5 most popular cup sizes reducing the number of lid skus that operators need to stock. Polystyrene.

18708230	DLX12R00007	Fits X12, X12K, X16N, X20N, X22N, White	2000/cs.
18708231	DLX2R100007	Fits X12, X12N, X16, X16N, X20, X20N, White	1000/cs.



B. HANDI-KUP® UNIVERSAL HOT/COLD BIG DRINK CUPS/LIDS

WINCUP

WinCup smoothwall foam cups can be used for hot beverages and cold drinks. Expandable polystyrene bead construction.

19409008	H8S	8 oz., White	1000/cs.
19404610	H10S	10 ⁷ / ₈ oz., White	1000/cs.
19401221	C12A	12 oz., White	1000/cs.
19406182	C1213	13 ¹ / ₈ oz., White	1000/cs.
19400118	C12APP	13 ¹ / ₂ oz., Profit Pals	1000/cs.
19400119	C1618PP	16 oz., Profit Pals	500/cs.
19401615	C1618	16 oz., White	500/cs.
19402022	C2022	22 oz., White	500/cs.
19400123	C3234PP	32 oz., Profit Pals	500/cs.
19403234	C3234	32 oz., White	500/cs.
19400124	C4244PP	44 ¹ / ₈ oz., Profit Pals	250/cs.
19400375	C4244	44 ¹ / ₈ oz., White	250/cs.

Drink-Thru Lids

Drink-thru, tear tab, lock back lids.

19400800	DT8	Fits H8S, White	1000/cs.
19400310	DT10	Fits H10S, White, w/Straw Slot	1000/cs.
19400576	DT18B	Fits C12A, White	1000/cs.
19400313	DT12	Fits C1213, C1416, White	1000/cs.

Multi-purpose drink-thru lid.

19400349	DL18	Fits 12-24 oz., White	10/100/cs.
----------	------	-----------------------	------------

Straw Slot Lids

19400743	L12S	Fits C1213, C1416, Translucent	10/100/cs.
19400449	L18S	Fits C12A, C1618, C2022, Translucent	1000/cs.
19402032	L32S	Fits C3234, C4244, Simplicity	500/cs.

Vented Lids

19401050	FL	Fits 6-8B, 8FC, 8-10B, 12FC, 16FC, Translucent	500/cs.
19400712	L8V	Fits H8S, White, Swirl	1000/cs.



C. JAVALICIOUS™ COFFEE CUP

WINCUP

The Javalicious™ design features rich and robust coffee colors printed on insulated foam cups. The design is printed using new laser engraving technology. This new technology transcends the four color standard and creates the appearance of up to eight colors. Insulated foam maintains hot temperatures longer; no need for double cupping, no need for sleeves.

19400517	213574	16 oz.	500/cs.
----------	--------	--------	---------

D. PROFIT PALS® HOT/COLD DRINK CUPS

WINCUP

Scanable bar codes for quicker check-out. Color coded sizes.

19400692	32C32PP	32 oz., Profit Pals	300/cs.
19400120	44C32PP	44 oz., Profit Pals	250/cs.



CUPS

Foam Cups & Lids/Specialty Cups



A. STYROCUP® FOAM CUP			WINCUP
Ideal for hot or cold drinks. Ideal for all markets, grocery chains, mass merchandisers, drug chains, discount stores. Easily recognized by retailers and consumers.			
19400240	240H	16 oz., White, Retail Pack	240/cs.



B. WINCUP UNIVERSAL HOT/COLD DRINK CUPS			WINCUP
WinCup smoothwall foam cups can be used for hot beverages and cold drinks. Expandable polystyrene bead construction.			
19400434	4C4	4 oz., 4L, White	1000/cs.
19400703	6C6	6 oz., 6L, White	1000/cs.
19404229	8C8	8 oz., White	1000/cs.
19401240	C12ASIM	12 oz., Simplicity®	25/40/cs.
19400444	12C18	12 oz., White	1000/cs.
19400445	14C18	14 oz., White	1000/cs.
19406183	16C16	16 oz., White	500/cs.
19400446	16C18	16 oz., White	500/cs.
19400447	20C18	20 oz., White	500/cs.
19406184	20C16	20 ⁷ / ₈ oz., White	500/cs.
19404235	24C18	24 oz., White	300/cs.

C. VENTED LIDS			WINCUP
Vented polystyrene lids.			
19400711	L6V	Fits 6 oz., White	1000/cs.
19400641	FL6V	Fits C1213, F6, F8M, Translucent	1000/cs.
19400308	FL8V	Fits 6GEF9, 6GEG0, 6GEG1, 6GEG2, Translucent	1000/cs.
19409032	L32V	Fits C3234, C4244, Translucent	500/cs.

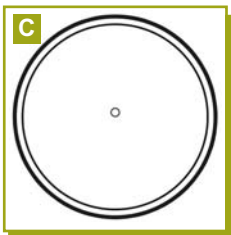

D. WINCUP STRAW SLOT LID			WINCUP
Straw slot lid.			
19404242	24LS	Fits 24 oz., Translucent	500/cs.

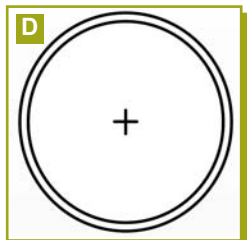

SPECIALTY CUPS

E. HEFTY EASY GRIP CUPS			PACTIV
Great for oral care. Help reduce the spread of germs in your house by using these 3 oz. white plastic cups after brushing. Each cup offers a slip resistant grip for secure handling and a clean white look.			
16201226	C20315	3 oz., White	1800/cs.



F. CONE WATER CUPS			GENPAK
Tightly rolled edges to increase cup rigidity.			
34780449	4F	4 oz., White, Rolled Rim	5000/cs.
34780042	42F	4 ¹ / ₂ oz., White, Rolled Rim	5000/cs.



G. BARE® ECO-FORWARD® TREATED PAPER CONE WATER CUPS			SOLO®
Solo® Foodservice is committed to making a positive difference to the environment, offering a full portfolio of Eco-Forward® products with various environmental attributes. Cone cups help keep things tidy around the water cooler because they can't be set down and left behind. There are also several packing options available: caddy bag, caddy box, chipboard box and plastic sleeve inners.			
18208225	442050	3 oz., Chipboard Inner Box, White	5000/cs.
18208201	4R2050	4 oz., Chipboard Box Inner Packaging, White	5000/cs.
18208203	4BR2050	4 oz., Plastic Sleeve Inner Packaging, White	5000/cs.
18208215	42R2050	4 ¹ / ₄ oz., Chipboard Box Inner Packaging, White	5000/cs.
18208800	6RB2050	6 oz., Plastic Sleeve Inner Packaging, White	5000/cs.
18200080	8RB2050	8 oz., Plastic Sleeve Inner Packaging, White	2500/cs.



Specialty Cups/Cup Dispensers



A. CONE SODA CUPS

SOLO®

High quality, leak-proof paper soda cups in a cone shape. Ideal for both water dispensers as well as snow cones.

18208801 6R 6 oz., White 5000/cs.



B. PAPER FUNNEL CUPS

SOLO®

Economical funnel cups are constructed of specially-treated paper with fully rolled rims.

18207325 10BFC 10 oz., Check Your Oil 1000/cs.

C. WATER CUPS

SOLO®

Cone shaped paper water cup with a rolled rim.

18208206 42BR 4 1/4 oz., Plastic Sleeve Inner-Pack 5000/cs.



D. COZY® CUP HOLDER/INSERT

SOLO®

Solo® Cozy® Cups never seem to go out of style - and why should they? They make a convenient and inexpensive alternative to ceramic mugs.

18208916 68RWA Walnut Mug 12/cs.

18200806 806A Insert, 7 oz., White 2000/cs.



E. PLASTIC MUG

SOLO®

No-tip pedestal. Two-finger grip. Uses lid # LH6.

18704326 SS78BK 7 oz., Black 500/cs.

CUP DISPENSERS

F. EZ-FIT® CUP DISPENSER

SAN JAMAR

Patented design effortlessly accommodates any size of disposable cup. The One Size Fits All EZ-Fit® gasket design works with paper, plastic and foam beverage cups. Smooth and controlled dispensing of cups. Includes four pre-cut gaskets to accommodate 8 to 46 oz. beverage cups with rim diameters ranging from 2 7/8" to 4 3/4". Can be mounted vertically or horizontally to work most efficiently with your application.

62572410 C2410C 23 1/4"L, 2 7/8" - 4 3/4" Rim dia. 1/ea.



G. PULL-TYPE CUP DISPENSERS

SAN JAMAR

Pull-type beverage cup dispensers combine stainless steel quality with universal dispensing of any type of disposable cup. The patented adjustable dispensing collar adjusts to any cup size or material. Included brackets allow for either wall or dispenser stand mounting. Dispenser is top-loaded and gravity fed.

62572900 C3200P 6 to 10 oz. Cups, 2 7/32" - 3 3/16" Rim dia. 1/ea.

62572904 C3400P 12 to 24 oz. Cups, 2 3/4" - 3 7/8" Rim dia. 6/cs.

62572908 C3500P 32 to 46 oz. Cups, 4" - 4 7/8" Rim dia. 1/ea.



H. PULL-TYPE FOAM CUP DISPENSER

SAN JAMAR

Self-adjusting unbreakable polyethylene dispenser eliminates foam cup damage. Stand or wall mount. Top-loading gravity fed.

62570059 C4410PFSD 12 to 24 oz. Cups, 23 1/2"L, 3 1/4" - 3 7/8" Rim dia. 1/ea.

I. PULL-TYPE PAPER CUP DISPENSER

SAN JAMAR

Pull-type paper cup dispenser. Self-adjusting plastic for simple economic dispensing of paper cups. Top-loading, gravity fed. Constructed of unbreakable polyethylene.

62574410 C4410PRD 12 to 24 oz. Cups, 23 1/2"L, 3 3/8" - 3 7/8" Rim dia. 1/ea.

J. CUP DISPENSER

SOLO®

Pull type, wall mount dispenser for 6 to 14 oz. cold drink cups as well as six and eight oz. hot drink cups.

18203090 3200P Satinless Steel 1/ea.



CUPS



Notes

CUPS

Picks & Skewers/Stirrers



PICKS & SKEWERS

A. PRIME SOURCE® FRILL PICKS/TOOTHPICKS PRIME SOURCE®

High-quality wood. For use in a wide variety of applications.

Frill Picks

75002176	75002176	750 ct., 2 1/2", Sandwich Pick	36000/cs.
75002180	75002180	1000 ct., 3", Regular	10000/cs.
750021815	75002181	1000 ct., 4", Club	1000/cs.
75002181	75002181	1000 ct., 4", Club	10000/cs.

Toothpicks

75002188	75002188	500 ct., Individually Paper Wrapped, Mint	6000/cs.
75002166	75002166	1000 ct., Individually Paper Wrapped, Mint	15000/cs.
75002185	75002185	1000 ct., Individually Cello Wrapped	15000/cs.
75002186	75002186	1000 ct., Individually Cello Wrapped, Mint	15000/cs.
750021905	75002190	800 ct., Round	19200/bx.
75002190	75002190	800 ct., Round	96000/cs.
75002183	75002183	750 ct., Sandwich Picks	36000/cs.
75002184	75002184	750 ct., Sandwich Picks Retail Pack	2/24/750/cs.



B. PRIME SOURCE® CORN DOG STICKS PRIME SOURCE®

High-quality wood. For use in a wide variety of applications such as cooking, cleaning, and personal hygiene.

75002200	75002200	Natural White, Bulk Pack	10000/cs.
----------	----------	--------------------------	-----------

C. PRIME SOURCE® SKEWERS PRIME SOURCE®

High-quality wood. For use in a wide variety of applications.

75002195	75002195	1000 ct., 4 1/2"	10000/cs.
75002196	75002196	1000 ct., 5 1/2"	10000/cs.
75002199	75002199	1000 ct., 7"	10000/cs.
75002198	75002198	1000 ct., 10"	3000/cs.



D. PRIME SOURCE® SQUARE EDGE STICKS PRIME SOURCE®

Birch wood sticks. Square edge.

75002208	75002208	10" x 2mm	10000/cs.
----------	----------	-----------	-----------

STIRRERS

E. PRIME SOURCE® COFFEE STIRRERS PRIME SOURCE®

High-quality wood. For use in a wide variety of applications.

75002193	75002193	5 1/2", Round End, 1000 ct.	10000/cs.
75002194	75002194	5 1/2", Square End, 1000 ct.	10000/cs.
75002203	75002203	7" x 1/4", 1000 ct.	10000/cs.



F. PRIME SOURCE® STIR STICKS PRIME SOURCE®

Our straws are of the highest quality and are the most durable. You'll never find a split end with any of our straws. Our neon colors are unique and a definite attention getter.

76009717	76009717	5 3/4", White/Red Stripe	10000/cs.
----------	----------	--------------------------	-----------



G. BAR-PAK™ STIRRERS CELL-O-CORE

Made with virgin resins; no inconsistent regrinds. Non-toxic pigments. Accurate counts.

68174702	EC5RED10PK	5", Red	10000/cs.
68170203	BS5BK	5 1/4", Black	10000/cs.
68170190	BS5RD	5 1/4", Red	10000/cs.
68174700	BS5RW	5 1/4", Red/White Stripe	1000/cs.
68170204	BS5WR	5 1/4", White/Red Stripe	10000/cs.
68170040	BS805	5 1/2", Large, White/Red Stripe	10000/cs.
68170055	BS55WR	5 1/2", Double Barrel/Coffee, White/Red Stripe	10000/cs.
68170132	BS725BR	7 1/4", Brown	10/100/cs.
68170130	BS725R	7 1/4", Red Ribbed	10/100/cs.
68170206	BS725WR	7 1/4", White/Red Stripe	10000/cs.



RESTAURANT, BAR & OFFICE SUPPLIES

Stirrers/Straws



A



A. STIRRERS

SOLO®

Unwrapped coffee/bar stirrers.

18204340 SR55RX0011 Red w/White Stripe, Box 10/1000/cs.

STRAWS

B. PRIME SOURCE® UNWRAPPED STRAWS

PRIME SOURCE®

Highest quality and are the most durable. You'll never find a split end with any of our straws.

Collins Straws

76009772 76009772 8", White/Red 5000/cs.

Collins Straw/Stirs

75002365 75002365 8", Red 5000/cs.

Fat Straws

75002369 75002369 6", Assorted Neon 3000/cs.

75002371 75002371 6", Black 3000/cs.

75002373 75002373 6", Neon Orange 3000/cs.

75002370 75002370 6", Red 3000/cs.

75002372 75002372 6", Yellow 3000/cs.

75002375 75002375 8", Assorted Neon 2400/cs.

75002379 75002379 8", Black 2400/cs.

75002381 75002381 8", Green 2400/cs.

75002376 75002376 8", Neon Orange 2400/cs.

75002377 75002377 8", Neon Pink 2400/cs.

75002382 75002382 8", Red 2400/cs.

75002378 75002378 8", Yellow 2400/cs.

Frappe Straws

75002340 75002340 4", Red 5000/cs.

Giant Straws

75002407 75002407 7³/₄", Black, Approx. 0.3" dia. 1500/cs.

75002413 75002413 8", Assorted Color, Approx. 0.3" dia. 3200/cs.

75002414 75002414 8", Black, Approx. 0.3" dia. 3200/cs.

Jumbo Straws

75002384 75002384 6", Red, Approx. 0.22" dia., 2500/cs.

75002425 75002425 6", Red, Approx. 0.22" dia., 3000/cs.

75002387 75002387 7³/₄", Black, Approx. 0.22" dia. 2500/cs.

75002388 75002388 7³/₄", Clear, Approx. 0.22" dia. 2500/cs.

76009703 76009703 7³/₄", Clear 48/250/cs.

76009733 76009733 7³/₄", Clear, Approx. 0.22" dia. 12500/cs.

75002389 75002389 7³/₄", Red, Approx. 0.22" dia. 2500/cs.

75002393 75002393 7³/₄", Translucent, Approx. 0.22" dia. 2500/cs.

75002391 75002391 8", Black, Approx. 0.22" dia. 4500/cs.

Slim Straws

75002360 75002360 8", Black 5000/cs.

75002361 75002361 8", Assorted Neon 5000/cs.

C. PRIME SOURCE® WRAPPED STRAWS

PRIME SOURCE®

Highest quality and are the most durable. You'll never find a split end with any of our straws.

Giant Straws

76009770 76009770 7³/₄", White/Red 7200/cs.

Hi-Valu Jumbo Straws

73007500 73007500 7³/₄", Clear 9600/cs.

Jumbo Straws

76009741 76009741 7³/₄", Clear 2000/cs.

76009731 PS24/500CLR 7³/₄", Clear, Import 24/500/cs.

75002394 75002394 7³/₄", Clear 24/500/cs.

760097045 76009704 7³/₄", White 400/cs.

76009704 76009704 7³/₄", White 10000/cs.

760097005 76009700 7³/₄", White/Red 500/cs.

76009700 PS50/250W/R 7³/₄", White/Red 24/500/cs.

76009743 PS50/250W/R 7³/₄", White/Red 50/250/cs.

76009702 76009702 10¹/₄", Clear 2000/cs.

Milk Straws

76009757 76009757 5³/₄", White, Wrapped 12000/cs.

Zombie Straws

75002420 75002420 10¹/₂", Red 450/cs.

B - C

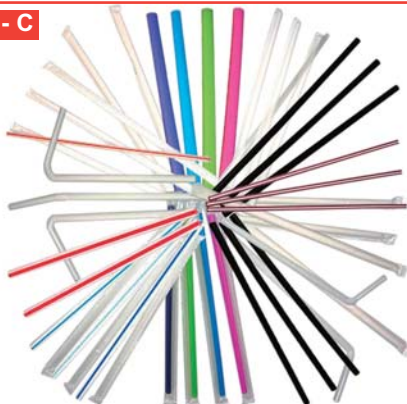

RESTAURANT, BAR & OFFICE SUPPLIES

Straws



A. UNWRAPPED STRAWS CELL-O-CORE

Made with virgin resins; no inconsistent regrinds. Non-toxic pigments. Accurate counts.

Bar-Pak™ Collins Straw/Stirs

68170210	BS808	8", Assorted Neon	5000/cs.
68170209	BS808BLK	8", Black	5000/cs.
68170208	BS8RD	8", Red	5000/cs.

Bar-Pak™ Fat Straws

68170212	6BPNA6500	6", Assorted Neon	3000/cs.
68170217	6BPBK6500	6", Black	3000/cs.
68170218	8BPNA6400	8", Assorted Neon	2400/cs.
68170222	8BPBK6400	8", Black	2400/cs.

Bar-Pak™ Giant Straws

68174600	TGU4300RD	10 1/4", Red	1200/cs.
----------	-----------	--------------	----------

Jumbo Straws

68170167	BS515BK	5 3/4", Black	2500/cs.
68170171	BS502BK	5 3/4", Black	12500/cs.
68170169	BS515CL	5 3/4", Clear	2500/cs.
68170183	BS510NA	7 3/4", Assorted Neon	2500/cs.
68170192	BS510BK	7 3/4", Black	1500/cs.
68170197	BS510BK	7 3/4", Black	2500/cs.
68170236	JU50250BK	7 3/4", Black	12500/cs.
68170193	BS510RD	7 3/4", Red	1500/cs.
68170198	BS510RD	7 3/4", Red	2500/cs.
68170231	JU50250	7 3/4", Translucent	12500/cs.
68174551	TJU4500	10 1/4", Translucent	2000/cs.

Scoop Spoon/Straws

68170781	SS8RD	8", Red, Jumbo	5000/cs.
----------	-------	----------------	----------



B. WRAPPED STRAWS CELL-O-CORE

Made with virgin resins; no inconsistent regrinds. Non-toxic pigments. Accurate counts.

Bar-Pak™ Giant Straws

68174302	GW24300CL	7 3/4", Clear	7200/cs.
68174301	GW24300RD	7 3/4", Red	7200/cs.
68174303	GW24300WR	7 3/4", White/Red Stripe	7200/cs.
68174590	TGW924300	9", Clear	7200/cs.
68174580	TGW4300RD	10 1/4", Red	1200/cs.
68174582	TGW4300	10 1/4", Translucent	1200/cs.
68174591	TGW124300RD	12", Red	1200/cs.

Flexible Straws

68170500	FW825400	7 3/4", White	10000/cs.
----------	----------	---------------	-----------

Giant Straws

68170121	TGW924300RED	9", Red	7200/cs.
----------	--------------	---------	----------

Jumbo Straws

68174404	JW24BK	7 3/4", Black	5000/cs.
68170238	JU10500	7 3/4", Translucent	5000/cs.
68174485	JW24WR	7 3/4", White/Red Stripe	2000/cs.
68174506	TJW4500RD	10 1/4", Red	2000/cs.
68170007	TJW4500	10 1/4", Translucent	2000/cs.
68174504	TJW4500WR	10 1/4", White/Red Stripe	2000/cs.



C. DIXIE® STIR STRAWS GEORGIA-PACIFIC

Hollow stir/straws strong enough to resist high temperatures.

15000182	HS551	5 1/2", White/Red Stripe, Unwrapped	10000/cs.
----------	-------	-------------------------------------	-----------

D. JUMBO STRAWS GEORGIA-PACIFIC

Jumbo wrapped straws.

15007775	JW7	.22" dia., 7 3/4", Translucent, Wrapped	12000/cs.
----------	-----	---	-----------



Straws/Taster Spoons/Mediumweight Cutlery



A. NATURE FRIENDLY® STRAWS NATURE FRIENDLY PRODUCTS

Nature Friendly Products' 100% biodegradable and compostable tableware provides consumers with an eco-friendly alternative to traditional disposables. Made from sugar cane bagasse-based renewable resources, they are completely compostable within 50-100 days in home and commercial composting facilities. These products are superior in strength and performance. Non-toxic, hot/cold tolerant, oil and water resistant, microwave and freezer safe.

C6935078	ST775N4500W	7 ¹ / ₄ ", Giant, Wrapped	2000/cs.
C6935077	ST1025G12300W	10 ¹ / ₄ ", Jumbo, Wrapped	1200/cs.



B. GIANT STRAWS PACTIV

Giant straws.			
16202021	STWG85B10B	8 ³ / ₈ ", Blue, Wrapped, Approx. 0.3" dia.	3000/cs.



C. SOLO® STRAWS SOLO®

With Solo, expect to find all the top-quality straw options you could dream of.

Giant Straws - Wrapped			
18200591	854TG2050	8 ¹ / ₄ ", Translucent, Paper Wrapped	10800/cs.
18204332	834TX2050	10 ¹ / ₄ ", Translucent, Paper Wrapped	1200/cs.
Jumbo Soda Straws - Unwrapped			
18204334	722TX0075	7 ³ / ₄ ", Translucent, Polypropylene	12500/cs.
Jumbo Soda Straws - Wrapped			
18202830	12830	7 ³ / ₄ ", Clear	12000/cs.
18204338	832TX0200	10", Translucent	6000/cs.
Slim Milk Straws - Wrapped			
18201808	11610	5 ³ / ₄ ", White	12000/cs.
Slim Soda Straws - Unwrapped			
18201788	818700075	7 ³ / ₄ ", Red w/White Stripe, Polypropylene	5000/cs.
Super Jumbo Straws - Wrapped			
18202820	12820	7 ³ / ₄ ", Stripe	12000/cs.



TASTER SPOONS

D. PRIME SOURCE® TASTER SPOONS PRIME SOURCE®

Polystyrene taster spoons.			
75002529	75002529	3", Lightweight, White	250/cs.
75002677	75002677	3", Mediumweight, White	3000/cs.
75002778	75002778	3", Mediumweight, White	3000/cs.
Polypropylene taster spoon.			
75000073	75000073	3", Mediumweight, White	3000/cs.



E. DISPOSABLE TASTER SPOON SOLO®

Made with convenience in mind.			
18203603	000800222	3", White	3000/cs.



MEDIUMWEIGHT CUTLERY

F. HI-VALU DISPOSABLE CUTLERY HI-VALU

Made from break-resistant polypropylene. Mediumweight.			
73002496	73002496	Fork, White, Bagged	1000/cs.
73002495	73002495	Knife, White, Bagged	1000/cs.

Mediumweight Cutlery



A. PRIME SOURCE® POLYPROPYLENE DISPOSABLE CUTLERY

PRIME SOURCE®

Made from break-resistant polypropylene for extended use. Specifically engineered for the ideal combination of size, balance, and strength. Trim, sleek styling is contemporary and comfortable to use.

Mediumweight - 100 ct. Bagged

75002499	75002499	Teaspoon, White	1000/cs.
75002498	75002498	Soup Spoon, White	1000/cs.
75002497	75002497	Spork, White	1000/cs.
75002496	75002496	Fork, White	1000/cs.
75002495	75002495	Knife, White	1000/cs.

Mediumweight - Bulk

75002504	75002504	Teaspoon, Black	1000/cs.
75002503	75002503	Soup Spoon, Black	1000/cs.
75002502	75002502	Spork, Black	1000/cs.
75002501	75002501	Fork, Black	1000/cs.
75002500	75002500	Knife, Black	1000/cs.
75002494	75002494	Teaspoon, White	1000/cs.
75002493	75002493	Soup Spoon, White	1000/cs.
75002492	75002492	Spork, White	1000/cs.
75002491	75002491	Fork, White	1000/cs.
75002490	75002490	Knife, White	1000/cs.

Mediumweight - Bulk Economy

75002694	75002694	Teaspoon, White	1000/cs.
75002693	75002693	Soup Spoon, White	1000/cs.
75002692	75002692	Spork, White	1000/cs.
75002690	75002690	Knife, White	1000/cs.
75002691	75002691	Fork, White	1000/cs.

Mediumweight - Wrapped

75002485	75002485	Teaspoon, White	1000/cs.
75002484	75002484	Soup Spoon, White	1000/cs.
75002483	75002483	Spork, White	1000/cs.
75002482	75002482	Fork, White	1000/cs.
75002481	75002481	Knife, White	1000/cs.

Mediumweight - Wrapped Economy

75002599	75002599	Teaspoon, White	1000/cs.
75002598	75002598	Soup Spoon, White	1000/cs.
75002596	75002596	Fork, White	1000/cs.
75002595	75002595	Knife, White	1000/cs.

Mid-Heavyweight - Wrapped

75002400	75002400	Teaspoon, White	1000/cs.
----------	----------	-----------------	----------

B. PRIME SOURCE® POLYSTYRENE DISPOSABLE CUTLERY

PRIME SOURCE®

Specifically engineered for the ideal combination of size, balance, and strength. Trim, sleek styling is contemporary and comfortable to use.

Mediumweight - Bulk

75002604	75002604	Teaspoon, Almond	1000/cs.
75002603	75002603	Soup Spoon, Almond	1000/cs.
75002601	75002601	Fork, Almond	1000/cs.
75002600	75002600	Knife, Almond	1000/cs.
75002509	75002509	Teaspoon, Black	1000/cs.
75002508	75002508	Soup Spoon, Black	1000/cs.
75002506	75002506	Fork, Black	1000/cs.
75002505	75002505	Knife, Black	1000/cs.
75002514	75002514	Teaspoon, Clear	1000/cs.
75002513	75002513	Soup Spoon, Clear	1000/cs.
75002511	75002511	Fork, Clear	1000/cs.
75002510	75002510	Knife, Clear	1000/cs.
75002559	75002559	Teaspoon, White	1000/cs.
75002558	75002558	Soup Spoon, White	1000/cs.
75002556	75002556	Fork, White	1000/cs.
75002555	75002555	Knife, White	1000/cs.



RESTAURANT, BAR & OFFICE SUPPLIES

Mediumweight Cutlery



RESTAURANT, BAR & OFFICE SUPPLIES



A. PRIME SOURCE® DISPOSABLE CUTLERY PRIME SOURCE®

Specifically engineered for the ideal combination of size, balance, and strength. Trim, sleek styling is contemporary and comfortable to use.

Mediumweight Polypropylene - Wrapped

75002684	75002684	Teaspoon, Black	1000/cs.
75002683	75002683	Soup Spoon, Black	1000/cs.
75002682	75002682	Spork, Black	1000/cs.
75002681	75002681	Fork, Black	1000/cs.
75002680	75002680	Knife, Black	1000/cs.
75002755	75002755	Teaspoon, White	1000/cs.
75002754	75002754	Soup Spoon, White	1000/cs.
75002753	75002753	Spork, White	1000/cs.
75002752	75002752	Fork, White	1000/cs.
75002751	75002751	Knife, White	1000/cs.

Mediumweight Polystyrene - Wrapped

75000069	75000069	Teaspoon, Black	1000/cs.
75000071	75000071	Soup Spoon, Black	1000/cs.
75000068	75000068	Fork, Black	1000/cs.
75000070	75000070	Knife, Black	1000/cs.
75002314	75002314	Teaspoon, White	1000/cs.
75002313	75002313	Soup Spoon, White	1000/cs.
75002311	75002311	Fork, White	1000/cs.
75002310	75002310	Knife, White	1000/cs.

B. DISPOSABLE CUTLERY GEORGIA-PACIFIC

Mediumweight polypropylene construction provides rigidity and strength. Strong, shatter resistant and durable.

15000602	PTM21	Teaspoon, Dense Pack, White	1000/cs.
15000921	PFM21	Fork, Dense Pack, White	1000/cs.
15003021	PKM21	Knife, Dense Pack, White	1000/cs.

C. DISPOSABLE CUTLERY NUTRI-BON

Mediumweight polypropylene disposable plastic cutlery.

A6043642	3642	Teaspoon, Poly Pack, White	10/100/cs.
A6043643	3643	Soup Spoon, Poly Pack, White	10/100/cs.
A6043640	3640	Fork, Poly Pack, White	10/100/cs.

D. REGAL™ BULK CUTLERY SOLO®

With options abound, Regal™ is another excellent choice. Regal's mediumweight and larger size is perfect for takeout dishes and steam-table catering functions. Mediumweight polypropylene.

18207011	MOWT0007	Teaspoon, White	1000/cs.
18207007	MOWF0007	Fork, White	1000/cs.
18207008	MOWK0007	Knife, White	1000/cs.

E. REGAL™ DISPOSABLE CUTLERY SOLO®

With options abound, Regal™ is another excellent choice. Mediumweight polypropylene. Individually wrapped.

18202657	MOK30004	Teaspoon, Standard Size, Black	1000/cs.
18202654	MOK10004	Fork, Standard Size, Black	1000/cs.
18202656	MOK20004	Knife, Standard Size, Black	1000/cs.
18208310	61070	Teaspoon, Standard Size, White	1000/cs.
18200446	MOW30007	Teaspoon, Larger Size, White	1000/cs.
18208325	61370	Soup Spoon, Standard Size, White	1000/cs.
18207012	MOW40007	Soup Spoon, Larger Size, White	1000/cs.
18202315	61170	Fork, Standard Size, White	1000/cs.
18206127	61270	Knife, Standard Size, White	1000/cs.

Mediumweight & Heavyweight Cutlery



A. RELIANCE™ MEDIUMWEIGHT POLYSTYRENE CUTLERY SOLO®

Stronger, better cutlery for less. Product design and optimized strength-to-weight ratio provides superior performance. Standard length and size - perfect fit for takeout or casual on-premise dining. Streamlined handle and improved grip. Interchangeable styling with Impress™. Four colors that tie in with any color scheme.

18209802	<i>RSKF0004</i>	Fork, Black, Bulk	1000/cs.
18209803	<i>RSKK0004</i>	Knife, Black, Bulk	1000/cs.
18203278	<i>RSAT0019</i>	Teaspoon, Champagne, Bulk	1000/cs.
18203273	<i>RSAF0019</i>	Fork, Champagne, Bulk	1000/cs.
18203274	<i>RSAK0019</i>	Knife, Champagne, Bulk	1000/cs.
18209816	<i>RSWT0007</i>	Teaspoon, White, Bulk	1000/cs.
18209809	<i>RSW40007</i>	Soup Spoon, White, Individually Wrapped	1000/cs.
18209813	<i>RSWF0007</i>	Fork, White, Bulk	1000/cs.
18209805	<i>RSW10007</i>	Fork, White, Individually Wrapped	1000/cs.



B. SIMPLE ELEGANCE® BOXED CUTLERY SOLO®

For higher-end usage, our Simple Elegance® cutlery keeps the cachet of your menu intact. Count on excellent performance every time. Polystyrene. Mid-Heavyweight.

18208120	<i>SEL6KN0019</i>	Knife, Champagne	1000/cs.
18705768	<i>SBX8SW0007</i>	Soup Spoon, White	1000/cs.



C. MALIBU COMPOSTABLE CUTLERY WNA COMET

Mediumweight disposable cutlery. Meets ASTM D6400 for biopolymers. Also compost using Cedar Grove's stringent test methods.

12200195	<i>CGFB120265</i>	Fork, Brown	600/cs.
-----------------	-------------------	-------------	---------



HEAVYWEIGHT CUTLERY

D. PRIME SOURCE® POLYPROPYLENE DISPOSABLE CUTLERY PRIME SOURCE®

Made from break-resistant polypropylene for extended use. Specifically engineered for the ideal combination of size, balance, and strength. Trim, sleek styling is contemporary and comfortable to use.

Heavyweight - Bulk

75002549	<i>75002549</i>	Teaspoon, Black	1000/cs.
75002548	<i>75002548</i>	Soup Spoon, Black	1000/cs.
75002546	<i>75002546</i>	Fork, Black	1000/cs.
75002545	<i>75002545</i>	Knife, Black	1000/cs.
75002574	<i>75002574</i>	Teaspoon, White	1000/cs.
75002573	<i>75002573</i>	Soup Spoon, White	1000/cs.
75002571	<i>75002571</i>	Fork, White	1000/cs.
75002570	<i>75002570</i>	Knife, White	1000/cs.

Heavyweight - Bulk Economy

75002871	<i>75002871</i>	Fork, Black	1000/cs.
75002870	<i>75002870</i>	Knife, Black	1000/cs.
75002836	<i>75002836</i>	Fork, Honey	1000/cs.
75002544	<i>75002544</i>	Teaspoon, White	1000/cs.
75002543	<i>75002543</i>	Soup Spoon, White	1000/cs.
75002541	<i>75002541</i>	Fork, White	1000/cs.
75002540	<i>75002540</i>	Knife, White	1000/cs.

Heavyweight - Wrapped

75002928	<i>75002928</i>	Soup Spoon, Black	1000/cs.
75002929	<i>75002929</i>	Teaspoon, Black	1000/cs.
75002926	<i>75002926</i>	Fork, Black	1000/cs.
75002925	<i>75002925</i>	Knife, Black	1000/cs.
75002944	<i>75002944</i>	Teaspoon, White	1000/cs.
75002943	<i>75002943</i>	Soup Spoon, White	1000/cs.
75002941	<i>75002941</i>	Fork, White	1000/cs.
75002940	<i>75002940</i>	Knife, White	1000/cs.





Heavyweight Cutlery

RESTAURANT, BAR & OFFICE SUPPLIES

A. PRIME SOURCE® HEAVYWEIGHT POLYSTYRENE DISPOSABLE CUTLERY PRIME SOURCE®

Specifically engineered for the ideal combination of size, balance, and strength. Trim, sleek styling is contemporary and comfortable to use.

Boxed

75002649	75002649	Teaspoon, Almond	1000/cs.
75002646	75002646	Fork, Almond	1000/cs.
75002645	75002645	Knife, Almond	1000/cs.
75002629	75002629	Teaspoon, Black	1000/cs.
75002628	75002628	Soup Spoon, Black	1000/cs.
75002626	75002626	Fork, Black	1000/cs.
75002625	75002625	Knife, Black	1000/cs.
75002639	75002639	Teaspoon, Clear	1000/cs.
75002638	75002638	Soup Spoon, Clear	1000/cs.
75002636	75002636	Fork, Clear	1000/cs.
75002635	75002635	Knife, Clear	1000/cs.
75002619	75002619	Teaspoon, White, w/Window	1000/cs.
75002618	75002618	Soup Spoon, White, w/Window	1000/cs.
75002616	75002616	Fork, White, w/Window	1000/cs.
75002615	75002615	Knife, White, w/Window	1000/cs.

Bulk

75002609	75002609	Teaspoon, Almond	1000/cs.
75002608	75002608	Soup Spoon, Almond	1000/cs.
75002606	75002606	Fork, Almond	1000/cs.
75002605	75002605	Knife, Almond	1000/cs.
75002564	75002564	Teaspoon, Black	1000/cs.
75002563	75002563	Soup Spoon, Black	1000/cs.
75002561	75002561	Fork, Black	1000/cs.
75002560	75002560	Knife, Black	1000/cs.
75002569	75002569	Teaspoon, Clear	1000/cs.
75002568	75002568	Soup Spoon, Clear	1000/cs.
75002566	75002566	Fork, Clear	1000/cs.
75002565	75002565	Knife, Clear	1000/cs.
75002554	75002554	Teaspoon, White	1000/cs.
75002553	75002553	Soup Spoon, White	1000/cs.
75002551	75002551	Fork, White	1000/cs.
75002550	75002550	Knife, White	1000/cs.
75000050	75000050	Teaspoon, White, Mottled Handle	1000/cs.
75000051	75000051	Soup Spoon, White, Mottled Handle	1000/cs.
75000049	75000049	Fork, White, Mottled Handle	1000/cs.
75000048	75000048	Knife, White, Mottled Handle	1000/cs.

Wrapped

75002304	75002304	Teaspoon, Black	1000/cs.
75002305	75002305	Soup Spoon, Black	1000/cs.
75002301	75002301	Fork, Black	1000/cs.
75002300	75002300	Knife, Black	1000/cs.
75000111	75000111	Teaspoon, Clear	1000/cs.
75000113	75000113	Soup Spoon, Clear	1000/cs.
75000110	75000110	Fork, Clear	1000/cs.
75000112	75000112	Knife, Clear	1000/cs.



Heavyweight Cutlery



A. PRIME SOURCE® EXTRA HEAVYWEIGHT POLYSTYRENE DISPOSABLE CUTLERY PRIME SOURCE®

Specifically engineered for the ideal combination of size, balance, and strength. Trim, sleek styling is contemporary and comfortable to use.

Boxed

75002654	75002654	Teaspoon, Almond	1000/cs.
75002653	75002653	Soup Spoon, Almond	1000/cs.
75002651	75002651	Fork, Almond	1000/cs.
75002650	75002650	Knife, Almond	1000/cs.
75002634	75002634	Teaspoon, Black	1000/cs.
75002633	75002633	Soup Spoon, Black	1000/cs.
75002631	75002631	Fork, Black	1000/cs.
75002630	75002630	Knife, Black	1000/cs.
75002644	75002644	Teaspoon, Clear	1000/cs.
75002643	75002643	Soup Spoon, Clear	1000/cs.
75002641	75002641	Fork, Clear	1000/cs.
75002640	75002640	Knife, Clear	1000/cs.
75002624	75002624	Teaspoon, White	1000/cs.
75002623	75002623	Soup Spoon, White	1000/cs.
75002621	75002621	Fork, White	1000/cs.
75002620	75002620	Knife, White	1000/cs.

Boxed Economy

75002689	75002689	Teaspoon, White	1000/cs.
75002686	75002686	Fork, White	1000/cs.
75002685	75002685	Knife, White	1000/cs.

Bulk

75002614	75002614	Teaspoon, Almond	1000/cs.
75002613	75002613	Soup Spoon, Almond	1000/cs.
75002611	75002611	Fork, Almond	1000/cs.
75002610	75002610	Knife, Almond	1000/cs.
75002579	75002579	Teaspoon, Black	1000/cs.
75002578	75002578	Soup Spoon, Black	1000/cs.
75002576	75002576	Fork, Black	1000/cs.
75002575	75002575	Knife, Black	1000/cs.
75002584	75002584	Teaspoon, Clear	1000/cs.
75002583	75002583	Soup Spoon, Clear	1000/cs.
75002581	75002581	Fork, Clear	1000/cs.
75002580	75002580	Knife, Clear	1000/cs.
75002589	75002589	Teaspoon, White	1000/cs.
75002588	75002588	Soup Spoon, White	1000/cs.
75002586	75002586	Fork, White	1000/cs.
75002585	75002585	Knife, White	1000/cs.

Bulk Economy

76002614	76002614	Teaspoon, Almond	1000/cs.
76002613	76002613	Soup Spoon, Almond	1000/cs.
76002611	76002611	Fork, Almond	1000/cs.
76002610	76002610	Knife, Almond	1000/cs.
76002579	76002579	Teaspoon, Black	1000/cs.
76002578	76002578	Soup Spoon, Black	1000/cs.
76002576	76002576	Fork, Black	1000/cs.
76002575	76002575	Knife, Black	1000/cs.
76002583	76002583	Spoon, Clear	1000/cs.
76002581	76002581	Fork, Clear	1000/cs.
76002580	76002580	Knife, Clear	1000/cs.
75002699	75002699	Teaspoon, White	1000/cs.
75002698	75002698	Soup Spoon, White	1000/cs.
75002696	75002696	Fork, White	1000/cs.
75002695	75002695	Knife, White	1000/cs.

Wrapped

75002942	75002942	Teaspoon, White	1000/cs.
75002946	75002946	Soup Spoon, White	1000/cs.
75002937	75002937	Fork, White	1000/cs.
75002945	75002945	Knife, White	1000/cs.



Heavyweight Cutlery



RESTAURANT, BAR & OFFICE SUPPLIES



A. DISPOSABLE CUTLERY GEORGIA-PACIFIC

Premium heavyweight cutlery, the next best thing to silverware. Strong, shatter resistant and durable.

15000383 FH11 7 1/8", Fork, Dense Pack, Champagne 1000/cs.

B. DISPOSABLE CUTLERY GEORGIA-PACIFIC

Heavy mediumweight polystyrene cutlery. Upscale image at a value price. Strong, shatter resistant and durable. Equivalent to many competitors heavyweight offering. Saves time, labor and money. No short counts or broken pieces, guaranteed.

15000663 KEWG10 Knife, Bagged, White 1000/cs.

C. DIXIE® DISPOSABLE CUTLERY GEORGIA-PACIFIC

Heavyweight polystyrene is the premium choice in cutlery and the next best thing to silverware.

Boxed

15006814 SH207 5 3/4", Soup Spoon, White, 100 ct. 1000/cs.

15000387 TH207 6", Teaspoon, White, 100 ct. 1000/cs.

15000384 KH207 7 1/2", Knife, White, 100 ct. 1000/cs.

Dense Pack™

15005154 TH517 6", Teaspoon, Black, 1000 ct. 1000/cs.

15005153 FH517 7 1/8", Fork, Black, 1000 ct. 1000/cs.

15002652 KH517 7 1/2", Knife, Black, 1000 ct. 1000/cs.

15005622 TH217 6", Teaspoon, White, 1000 ct. 1000/cs.

15000249 FH217 7 1/8", Fork, White, 1000 ct. 1000/cs.

15006815 KH217 7 1/2", Knife, White, 1000 ct. 1000/cs.



D. DIXIE® DISPOSABLE CUTLERY GEORGIA-PACIFIC

Heavy mediumweight polystyrene cutlery. Equivalent to many competitors heavyweight offering. Strong, shatter resistant and durable.

Boxed

15000418 TM507 5 7/8", Teaspoon, Black, 100 ct. 1000/cs.

15000416 FM507 6 1/3", Fork, Black, 100 ct. 1000/cs.

15002056 TM207 5 7/8", Teaspoon, White, 100 ct. 1000/cs.

15000245 SM207 5 3/4", Soup Spoon, White, 100 ct. 1000/cs.

15001027 FM207 6 1/3", Fork, White, 100 ct. 1000/cs.

15002016 KM207 7", Knife, White, 100 ct. 1000/cs.

Dense Pack™

15001991 TM517 5 7/8", Teaspoon, Black, 1000 ct. 1000/cs.

15001992 FM517 6 1/3", Fork, Black, 1000 ct. 1000/cs.

15001990 KM517 7", Knife, Black, 1000 ct. 1000/cs.

15007418 TM217 5 7/8", Teaspoon, White, 1000 ct. 1000/cs.

15007419 FM217 6 1/3", Fork, White, 1000 ct. 1000/cs.

15007420 KM217 7", Knife, White, 1000 ct. 1000/cs.



E. DIXIE® WRAPPED CUTLERY GEORGIA-PACIFIC

Individually wrapped heavyweight polypropylene cutlery is convenient and sanitary.

15003016 PFH53C 6", Fork, Black, Heavyweight 1000/cs.



F. CLASSIC BULK CUTLERY SOLO®

For the poolside reception or special occasion where both convenience and quality must be served, there is Solo® Classic. This "classic" design is extra sturdy, full-size and heavyweight. Polystyrene.

18204035 100240001 Fork, Black 1000/cs.

18203036 100250222 Knife, Black 1000/cs.

18201708 100180222 Teaspoon, Sandstone 1000/cs.

18201707 100160001 Fork, Sandstone 1000/cs.

18202026 100220222 Teaspoon, White 1000/cs.

Heavyweight & Biodegradable Cutlery



A. GUILDWARE® EXTRA HEAVY WEIGHT POLYSTYRENE CUTLERY

SOLO®

Polystyrene plastic handles most entrees due to the rigid/stiff material. Meets durability usage needs for foods that require cutting such as meats, poultry, and salads. Full-size design serves as best alternative to permanent flatware; ideal for upscale and casual adult dining applications (including catering and takeout). Allows the operator to match any décor or occasion. Black serves as a more upscale option. Available in multiple packaging options which allows a choice for cost and sanitation needs. Made in USA which reduces transportation costs and environmental impact.

Boxed

18701955	GBX7TS0019	Teaspoon, Champagne	1000/cs.
18701954	GBX8SS0019	Soup Spoon, Champagne	1000/cs.
18701940	GBX5FK0019	Fork, Champagne	1000/cs.
18701945	GBX6KN0019	Knife, Champagne	1000/cs.

Bulk

18700108	GDR7TS0004	Teaspoon, Black	1000/cs.
18700109	GDR8SS0004	Soup Spoon, Black	1000/cs.
18700106	GDR5FK0004	Fork, Black	1000/cs.
18700107	GDR6KN0004	Knife, Black	1000/cs.
18701920	GD7TS0019	Teaspoon, Champagne	1000/cs.
18701930	GD8SS0019	Soup Spoon, Champagne	1000/cs.
18701905	GD5FK0019	Fork, Champagne	1000/cs.
18701915	GD6KN0019	Knife, Champagne	1000/cs.
18701925	GD7TW0007	Teaspoon, White	1000/cs.
18701910	GD5FW0007	Fork, White	1000/cs.
18701917	GD6KW0007	Knife, White	1000/cs.



B. REFLECTIONS™ DISPOSABLE CUTLERY

WNA COMET

Reflections™ cutlery combines the radiant styling of fine flatware and the ease of single use. The only solution addressing the need for a formal presentation and the high costs associated with renting or owning permanent flatware.

12201432	620155	6 1/4", Spoon, Silver	600/cs.
12201430	610155	7", Fork, Silver	600/cs.
12201431	630155	7 1/2", Knife, Silver	600/cs.



BIODEGRADABLE CUTLERY

C. NATURE FRIENDLY® CUTLERY

NATURE FRIENDLY PRODUCTS

Made from a proprietary biodegradable resin. 100% biodegradable and compostable. Completely compostable within 50-100 days in properly managed composting facilities. Superior strength, quality performance. High temperature resistant up to 190°F. Impermeable and non-toxic.

C6935003	CHW300	Spoon (Bulk/100)	20/100/cs.
C6935009	CHW302	Spoon (Bulk/1000)	1000/cs.
C6935006	CHW301	Spoon (Individually Wrapped)	5/100/cs.
C6935001	CHW100	Fork (Bulk/100)	20/100/cs.
C6935007	CHW102	Fork (Bulk/1000)	1000/cs.
C6935004	CHW101	Fork (Individually Wrapped)	5/100/cs.
C6935002	CHW200	Knife (Bulk/100)	20/100/cs.
C6935008	CHW202	Knife (Bulk/1000)	1000/cs.
C6935005	CHW201	Knife (Individually Wrapped)	5/100/cs.
C6935050	CHW1200	Cutlery Combo Kit (4 Boxes/300 pc.)	1200/cs.



Biodegradable Cutlery



RESTAURANT, BAR & OFFICE SUPPLIES



A. BIOPLASTIC CUTLERY TRELLIS EARTH®

Bagged in a Trellis Earth® biodegradable bioplastic bag for a complete environmentally responsible package. Bioplastic cutlery is made from corn polymers, starches and complementary ingredients to create a blend that is 100% biodegradable and microwave or freezer safe. Just as effective as conventional plastic cutlery.

C4780045	<i>WFS10</i>	Soup Spoon, White	1000/cs.
C4780033	<i>WFS03</i>	Spoon, White	3000/cs.
C4780054	<i>WFS13</i>	Spork, White	1000/cs.
C4780002	<i>WFS02</i>	Fork, White	1000/cs.
C4780004	<i>WFS04</i>	Knife, White	1000/cs.

B. BIOPLASTIC CUTLERY TRELLIS EARTH®

Bioplastic cutlery is made from corn polymers, starches and complementary ingredients to create a blend that is 100% biodegradable and microwave or freezer safe. Just as effective as conventional plastic cutlery.



3-Piece Cutlery Sets

C4780074	<i>WFS71</i>	20 Sets, Fork, Knife, Spoon	1200/cs.
C4780090	<i>WFS51</i>	50 Sets, Fork, Knife, Spoon	900/cs.
C4780075	<i>WFS72</i>	50 Sets, Fork, Knife, Spoon	2400/cs.
C4780073	<i>WFS61</i>	200 Forks, 150 Spoons, 100 Knives	2700/cs.
C4780018	<i>WFS01</i>	250 Sets Bagged Basic	1000/cs.
C4780064	<i>WFS31</i>	250 Sets Bagged Premium	1000/cs.

Bulk

C4780055	<i>WFS11</i>	Tasting Spoon, White, 1000 ct.	1000/cs.
C4780024	<i>WFS08</i>	Soup Spoon, White, 100 ct.	1000/cs.
C4780006	<i>WFS06</i>	Spoon, White, 100 ct.	1000/cs.
C4780023	<i>WFS09</i>	Spork, White, 100 ct.	1000/cs.
C4780063	<i>CTS03</i>	Tasting Spork, 500 ct.	2500/cs.
C4780005	<i>WFS05</i>	Fork, White, 100 ct.	1000/cs.
C4780007	<i>WFS07</i>	Knife, White, 100 ct.	1000/cs.

Retail Inner Packs

Six inner cartons ready for stocking on shelves. Each inner retail pack is bar coded.

C4780094	<i>WFS58</i>	Soup Spoons, 100 ct.	600/cs.
C4780069	<i>WFS68</i>	Soup Spoons, 500 ct.	3000/cs.
C4780092	<i>WFS53</i>	Spoons, 100 ct.	600/cs.
C4780071	<i>WFS66</i>	Spoons, 500 ct.	3000/cs.
C4780076	<i>WFS74</i>	Forks, 60 ct.	1200/cs.
C4780091	<i>WFS52</i>	Forks, 100 ct.	600/cs.
C4780072	<i>WFS65</i>	Forks, 500 ct.	3000/cs.
C4780093	<i>WFS54</i>	Knives, 100 ct.	600/cs.
C4780070	<i>WFS67</i>	Knives, 500 ct.	3000/cs.



C. PREMIUM BIOPLASTIC CUTLERY TRELLIS EARTH®

Premium Bioplastic is stronger, heavier and more rigid than basic cutlery. Works beyond boiling, up to 248°F. Textured handles with Trellis trademark. Made from corn polymers, starches and complementary ingredients to create a blend that is 100% biodegradable and microwave or freezer safe.

C4780081	<i>WFS36</i>	Spoon, Beige	1000/cs.
C4780080	<i>WFS35</i>	Fork, Beige	1000/cs.
C4780082	<i>WFS37</i>	Knife, Beige	1000/cs.

D. PREMIUM BIOPLASTIC CUTLERY TRELLIS EARTH®

Carbon powder is as natural and organic a coloring as is possible, so we've decided to offer all our cutlery products in carbon powder black. Works beyond boiling, up to 240°F. Textured handle with Trellis trademark.

C4780066	<i>WFS46</i>	Spoon, Black	1000/cs.
C4780067	<i>WFS45</i>	Fork, Black	1000/cs.
C4780065	<i>WFS47</i>	Knife, Black	1000/cs.



Biodegradable Cutlery/Cutlery Kits



A. STATESMEN COMPOSTABLE CUTLERY WNA COMET

Our compostable line of products is an ecologically sound and practical choice. Earthsense™ offers superior performance and appearance vs. other "green" disposable products. Meets ASTM D6400 for biopolymers. Also compost using Cedar Grove's stringent test methods. Heavyweight.

12200149	<i>CGFB420605</i>	Spoon, Brown	600/cs.
12200150	<i>CGFB410605</i>	Fork, Brown	600/cs.
12200148	<i>CGFB430605</i>	Knife, Brown	600/cs.



CUTLERY KITS

B. PRIME SOURCE® 2 PC. DISPOSABLE CUTLERY KIT PRIME SOURCE®

Specifically engineered for the ideal combination of size, balance and strength. Trim, sleek styling is contemporary and comfortable to use.

75002724	<i>75002724</i>	Fork, Knife, White	500/cs.
-----------------	-----------------	--------------------	---------

C. PRIME SOURCE® 3 PC. MEDIUMWEIGHT DISPOSABLE CUTLERY KITS PRIME SOURCE®

Specifically engineered for the ideal combination of size, balance and strength. Trim, sleek styling is contemporary and comfortable to use.

75002517	<i>75002517</i>	Teaspoon, Fork, Knife, White	500/cs.
75002880	<i>75002880</i>	Spork, Straw, Napkin, Clear	1000/cs.
75002526	<i>75002526</i>	Spork, 5" Straw, 10" x 8" 1-Ply Napkin, White	1000/cs.
75002480	<i>75002480</i>	Spork, 5" Clear Straw, 10" x 10" Napkin, White	1000/cs.
75000107	<i>75000107</i>	Spork, 5 3/4" Milk Straw, 10" x 10" 1-Ply Napkin, White	1000/cs.
75000108	<i>75000108</i>	Spork, 5 3/4" Milk Straw, 10" x 12" 1-Ply Napkin, White	1000/cs.
75002488	<i>75002488</i>	Spork, 6" Clear Straw, 10" x 10" Napkin, White	1000/cs.
75002723	<i>75002723</i>	Fork, Knife, Napkin, White	500/cs.
75002533	<i>75002533</i>	Fork, Knife, 1-Ply Napkin, Black	500/cs.
75002528	<i>75002528</i>	Fork, Knife, 8" x 10" Napkin, White	500/cs.
75000114	<i>75000114</i>	Fork, Knife, 12" x 13" 1-Ply Napkin, Clear	1000/cs.
75000072	<i>75000072</i>	Fork, Knife, 12" x 13" 1-Ply Napkin, White	250/cs.



D. PRIME SOURCE® 4 PC. DISPOSABLE CUTLERY KITS PRIME SOURCE®

Specifically engineered for the ideal combination of size, balance and strength. Trim, sleek styling is contemporary and comfortable to use.

Mediumweight

75002475	<i>75002475</i>	Soup Spoon, Teaspoon, Fork, Knife, White	250/cs.
75002896	<i>75002896</i>	Teaspoon, Fork, 6" Straw, 10" x 10" Napkin, White	500/cs.
75002897	<i>75002897</i>	Teaspoon, Fork, Salt/Pepper, 10" x 12" Napkin, White	500/cs.
75000052	<i>75000052</i>	Teaspoon, Fork, Knife, Napkin, White	250/cs.
75002479	<i>75002479</i>	Teaspoon, Fork, Knife, 13" x 10 1/2" 1-Ply Napkin, White	250/cs.
75002486	<i>75002486</i>	Fork, Knife, Salt/Pepper, 10" x 10" 1-Ply Napkin, White	1000/cs.
75002593	<i>75002593</i>	Fork, Knife, Salt/Pepper, 10" x 10" 1-Ply Napkin, White, Economy	250/cs.
75002476	<i>75002476</i>	Fork, Knife, Salt/Pepper, 12" x 13" Napkin, White	250/cs.
75002892	<i>75002892</i>	Fork, Knife, Salt/Pepper, 13" x 13" Napkin, White	250/cs.

Heavyweight

75000053	<i>75000053</i>	Teaspoon, Fork, Knife, Napkin, White	250/cs.
75002524	<i>75002524</i>	Fork, Knife, Salt/Pepper, 12" x 13" Napkin, White	250/cs.

Cutlery Kits



A. PRIME SOURCE® 5 PC. DISPOSABLE CUTLERY KITS PRIME SOURCE®

Specifically engineered for the ideal combination of size, balance and strength. Trim, sleek styling is contemporary and comfortable to use.

Mediumweight

75000109	<i>75000109</i>	Teaspoon, Fork, Knife, 5 ³ / ₄ " Milk Straw, 10" x 12" 1-Ply Napkin, White	1000/cs.
75002489	<i>75002489</i>	Teaspoon, Fork, Knife, 6" Straw, 12" x 13" Napkin, White	500/cs.
75002516	<i>75002516</i>	Teaspoon, Fork, Knife, Salt/Pepper, 10" x 10" Napkin, White	250/cs.
75002487	<i>75002487</i>	Teaspoon, Fork, Knife, Salt/Pepper, 10" x 10" Napkin, White	250/cs.
75002594	<i>75002594</i>	Teaspoon, Fork, Knife, Salt/Pepper, 10" x 10" 1-Ply Napkin, White, Economy	250/cs.
75002733	<i>75002733</i>	Teaspoon, Fork, Knife, Salt/Pepper, 10" x 12" Napkin, Black	250/cs.
75002477	<i>75002477</i>	Teaspoon, Fork, Knife, Salt/Pepper, 12" x 13" Napkin, White	250/cs.
75002675	<i>75002675</i>	Teaspoon, Fork, Knife, Salt/Pepper, 13" x 17" Napkin, Black	250/cs.

Heavyweight

75002877	<i>75002877</i>	Teaspoon, Fork, Knife, Salt/Pepper, 13" x 17" Napkin, Black	250/cs.
75002900	<i>75002900</i>	Teaspoon, Fork, Knife, Salt/Pepper, 13" x 17" Napkin, White	250/cs.

Extra Heavyweight

75002878	<i>75002878</i>	Teaspoon, Fork, Knife, Salt/Pepper, 13" x 17" Napkin, Black	250/cs.
-----------------	-----------------	---	---------



B. DIXIE® CUTLERY COMBO BOX GEORGIA-PACIFIC

Heavy-duty forks, knives and teaspoons (56 sets).

15000168	<i>CM168</i>	168 ct., White	168/cs.
-----------------	--------------	----------------	---------



C. DIXIE® CUTLERY KEEPER GEORGIA-PACIFIC

Full size dinner length cutlery perfect for heavy, tough-to-cut food like steak and chicken. Houses strong, shatter resistant, durable cutlery. Re-closable plastic tray keeps cutlery organized. Crystal coordinates with any color of pattern. 60 pieces of each essential utensil: knives, forks, teaspoons.

15002182	<i>CH0180DX7</i>	60 Sets, Crystal, Heavyweight	1800/cs.
-----------------	------------------	-------------------------------	----------



D. SMARTSTOCK™ DISPOSABLE CUTLERY GEORGIA-PACIFIC

There isn't a more efficient or orderly way for you to stock, and your customers to select, the cutlery that is an essential part of your everyday foodservice operation. These pre-counted and pre-assembled refills make it fast and easy to restock an empty dispenser. Just pick up a new cutlery refill, slide it into the dispenser, rip and pull away the binding tape, close the door and you're done.

15008807	<i>SSS51</i>	6", Spoon, Refill, Black	960/cs.
15008808	<i>SSF51</i>	6 ¹ / ₂ ", Fork, Refill, Black	960/cs.
15008809	<i>SSK51</i>	7", Knife, Refill, Black	960/cs.



E. REGAL™ WRAPPED KITS SOLO®

With options abound, Regal™ is another excellent choice. Regal's mediumweight and larger size is perfect for takeout dishes and steam-table catering functions.

18200677	<i>64193</i>	4 Pc. (Teaspoon, Fork, Knife, 12" x 13" Napkin), White	500/cs.
18207006	<i>MOW8Y0007</i>	5 Pc. (Teaspoon, Fork, Knife, Salt/Pepper, 9" x 13" Napkin), White	250/cs.

Cutlery Kits/Servingware/Chafing Fuel



A. PREMIUM BAGGED BIOPLASTIC CUTLERY TRELLIS EARTH®

Three pieces of our highest grade cutlery colored black in a single, heat sealed poly bag.
C4780068 WFS41 3 Pc. (6¼" Spoon, 6¾" Fork, 7" Knife) 250/cs.



B. REFLECTIONS™ DISPOSABLE CUTLERY KIT WNA COMET

Reflections cutlery combines the radiant styling of fine flatware and the ease of single use. The only solution addressing the need for a formal presentation and the high costs associated with renting or owning permanent flatware.
12201433 612375 3 Pc. (Spoon, Fork, Knife), Silver 450/cs.



SERVINGWARE

C. CATERWARE® CATERMATE® SERVING UTENSILS PACTIV

Gloss black plastic serving utensils.
16209006 9006K 9" x 2", Spoon, Black 100/cs.
16209007 9007K 7", Tong, Black 100/cs.



D. SERVING TONGS SABERT

Elegant style. Sturdy and functional. (Clear version pictured.)
62200280 UBK72STNG 6½", Tongs, Black 72/cs.



CHAFING FUEL

E. STERNO® BRAND CRYSTALYTE® LIQUID WAX CARTRIDGE STERNO

Liquid wax cartridges make it easier, safer and more economical to create ambiance with table lamps. They are virtually odorless, has a bright clean burn and comes in a variety of burn times.
25080840 840 40 hr., 3⅜" 36/cs.



F. HANDY FUEL® CANNED HEAT™ COOKING FUEL STERNO

High heat output of a methanol gel for food applications. Consistent delivery for the promised burn-time. Versatile enough to use with a broad range of equipment.
25083008 HF03008 2 hr. 72/cs.



G. HANDY WICK® CHAFING FUEL STERNO

Twist cap with wick design provides long even flame. Twist cap is resealable and reusable.
25083006 HW03006 6 hr. 24/cs.

H. STERNO® GREEN CHAFING FUEL STERNO

Sterno® Green is the first chafing fuel to be endorsed by the Green Restaurant Association (GRA), meeting the organization's rigorous endorsement standards for promoting a cleaner, safer environment. Plant-based bio fuel made from renewable resources. Biodegradable and water soluble. Methanol-free formula is clean burning, odor free and smoke free. Smart Can™ heat indicator lets you know when can is hot.
25080001 ST04008G 2 hr. 72/cs.



I. STERNO® WICK CHAFING FUEL STERNO

High heat output for beverage service and other applications. Versatile enough to use with a broad range of equipment. Consistent delivery. Safe. Cool to the touch. Spill proof can with a visible flame.
25083009 ST03009 6 hr. 24/cs.



Grease Filters/Filter Powder/Grocery Items

RESTAURANT, BAR & OFFICE SUPPLIES

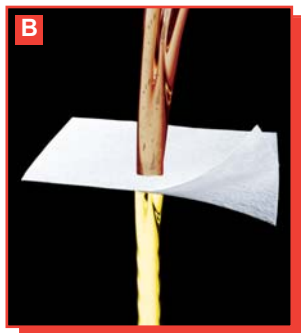

GREASE FILTERS

A. FILTER CONE HOLDER CCP

Manual filter cone holder.
27600781 FCH101 10"D 1/ea.

B. SHORTENING FILTERS CCP

Automatic filters. Envelopes.
27600757 D1113E4 11" x 13", 7/8" Hole 2 Sides, Belshaw 100/cs.
27600794 D1320E3 13 1/2" x 20 1/2", 1 1/4" Hole 1 Side, BKI 100/cs.
27604223 D1422E3 14" x 22", 1 1/2" Hole, 1 Side 100/cs.

FILTER POWDER

C. FILTER BRITE® FILTER POWDER CCP

Maintain food quality and extend oil life by filtering with Filter Brite®. The new Portion Pack makes filtering easier and insures the correct amount of powder is used every time. Made in the U.S.A.
27601560 FB560 5 oz. 60/cs.

GROCERY ITEMS

D. FOLGERS® COFFEE PROCTER & GAMBLE

Decaffeinated Coffee
 Satisfies decaffeinated coffee lovers. Patented fast decaffeination process delivers rich flavor which is virtually indistinguishable from regular Folgers®. Natural decaffeination removes 99.7% of caffeine without unnatural chemicals.

16906927 06927 0.9 oz., Ultra Roast 42/cs.
16900040 00374 22.6 oz., Decaf 6/cs.

Filter Packs
 Filter packs are the ultra convenient way to make your coffee in the morning. No fuss, no mess. Perfect for the office breakroom.

16900111 06125 0.9 oz., Classic Roast 36/cs.
16900098 06239 0.9 oz., Classic Roast 40/cs.
16900091 06122 0.9 oz., Decaf 40/cs.
16904192 06114 0.9 oz., Regular 160/cs.
16900094 06430 1.5 oz., Classic Roast 42/cs.

Regular Coffee
 Rich, smoother tasting Mountain Grown® flavor and aroma. Quality coffee served in more American homes than any other brand. Holds its flavor freshness longer than all competitive foodservice coffees.

16906930 06930 0.9 oz., Ultra Roast Heavy/Regular 42/cs.
16904087 06099 0.9 oz., Dark Brown 150/cs.
16903973 84943973 1.05 oz. 42/cs.
16900042 00367 33.9 oz. 6/cs.

E. STASERO SHAKABLE TOPPING STASERO

Blended to perfection using only the choicest ingredients, Stasero shakable toppings add excitement to lattes, cappuccinos, brewed coffee, icing, whipped cream, breads, cheese cakes, cookies, milk shakes and other quality desserts.

71282608 ST62608 5 1/2 oz. Shaker, Cinnamon 12/cs.

Grocery Items/Water Filters/Kitchen Items



A. BUNN® PAPER FILTERS BUNN-O-MATIC

Special paper grade assures optimum extraction of coffee's taste. Perfect for coffees requiring exact brewing, like decaf and flavored coffees. Superior stay-in-place design prevents coffee grounds overflow.

11400100	201060000	8½" x 3", A10/Retail, 8 & 10 cup Brewers/Home Models	1000/cs.
11406000	201150000	9¾" x 4¼", Regular, 12 cup Decanter Brewers	1000/cs.
11407631	201000000	12¾" x 5¼", Tea, Iced Tea Brewers, Single & Dual Coffee Brewers, 1.5 gal. Urns, System II®	500/cs.
11400139	201380000	13¾" x 5¼", Gourmet, Gourmet-Iced Tea, System II, Single TF, Dual TF, Single SH, Dual SH, Single, Dual, 1.5 gal. Urns	504/cs.
11402012	201200000	15½" x 5⅜", System III®, BUNN System III®	500/cs.
11406100	201090000	17¾" x 7¼", Urn & Iced Coffee, Urn - U3, SRU, IC-3	250/cs.
11407630	201250000	21" x 8¾", Urn - 6 gal.	250/cs.



WATER FILTERS

B. BRITA® ON TAP WATER FILTER CLOROX

Attaches easily to your faucet without tools. Eliminates bad tastes and odors by removing chlorine and hydrogen sulfide, the sulfur odor that can be found in tap water. Faucet Filters should be replaced every 100 gallons or every four months, whichever comes first. If you're unsure how long it's been, not to worry - the BRITA Faucet Filter has a built in Filter Replacement Indicator that flashes red when you need a new filter.

38382201	42201	Complete Water Filter	4/cs.
38382401	42401	Replacement Filter	6/cs.



C. BRITA® ULTRAMAX DRINKING WATER DISPENSER CLOROX

Larger capacity, one-touch dispenser that makes this pitcher ideal for families. Put it right on the counter or refrigerator shelf. Features an electronic filter change reminder. Includes dispenser and one filter.

38385530	35530	144 oz.	3/cs.
38385503	35503	Replacement Filters, 3-Pack	24/cs.



KITCHEN ITEMS

D. MEASURING CUP CCP

Metric and English graduations embossed on opposing sides. Self-draining bottom. I-beam handle with thumb grab control. Freezer safe to -40°F. Dishwasher safe. Deep handle width prevents burns when transferring hot liquids.

276098081	9808	8 oz., Clear	1/ea.
-----------	------	--------------	-------



E. SCOOP CCP

Durable poly clear scoops resist chipping, scratches and breakage. Beveled front edge for maximum pick-up. Hanging slot for efficient storage. Thumb indent for greater control and comfort. Reinforced gussets prevent flexing and breakage.

276099331	9932	32 oz., Clear	1/ea.
-----------	------	---------------	-------



F. DUR-X™ BUS/UTILITY BOX RUBBERMAID

Built to last. Includes reinforced handles, bottom and ribs for long life. Rounded corners for easy cleaning. Dishwasher safe.

17703350	3351BRN	21½"L x 17⅞"W x 7"H, Brown	6/cs.
----------	---------	----------------------------	-------



G. PROSAVE™ MOBILE INGREDIENT BIN RUBBERMAID

Patent-pending one handed access and integrated measuring tool increases preparation efficiency. Rectangular design improves space optimization under a preparation table or in a storeroom. Integrated sliding lid. Clear door. Integrated scoop and storage for food code compliance. All certified to NSF Std. #2. Casters allow ingredient bins to be transported.

17700017	360088	124 lb., 29¼" x 13⅞" x 28"H, White	1/ea.
----------	--------	------------------------------------	-------

Kitchen Items/Guest Checks



A. SCRAPER **RUBBERMAID**
 Traditional flat blades for scraping and spoon-shaped blades for easy spooning, scooping and spreading. Blades molded onto handles for permanent bond. Seamless construction resists dirt or bacteria build up. Dishwasher safe.
177019051 1905 1 3/2", White 1/ea.



GUEST CHECKS

B. GUEST CHECKS **NATIONAL CHECKING**
 Single board check has 13 lines with a "Menu Prompt" for better customer service. Lined back copy for beverages and a perforated receipt for the customer's record. Safety tinting to protect against fraud. This check may be used on kitchen check holders and in a cash register. 50 checks per book, 50 books per case (shrink wrapped five bundles of 10 books).
49201919 G4774SP 4 2/8" x 7 1/4", Green 2500/cs.

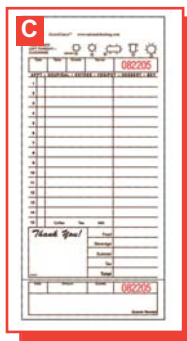

C. GUEST CHECKS **NATIONAL CHECKING**
 Single board tan guest check has 15 lines with "Pivot Points" and a "Menu Prompt" for better customer service. Lined back copy for beverages and a perforated receipt for the customer's record.
49208202 T4932SP 4 1/8" x 9", Tan, Shrink Wrapped 2000/cs.



D. GUEST CHECKS **NATIONAL CHECKING**
 Single paper green guest check has 16 lines with a "Menu Prompt" for better customer service. A numbered receipt stub is used for accounting purposes. 100 checks per book, 50 books per case.
49203616 G3616 3 1/2" x 6 3/4", Green 5000/cs.



E. GUEST CHECKS **NATIONAL CHECKING**
 Single board white GuestCheck™ has 16 lines with a "Menu Prompt" for better customer service. Lined back copy for beverages and a perforated receipt for the customer's record. 50 checks per book/50 books per case. (Shrink packed 5 bundles of 10 books.)
49200503 503SP 3 2/8" x 6 3/4", White, Spanish 2500/cs.

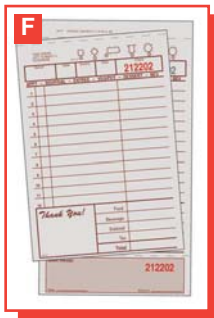

F. GUEST CHECKS **NATIONAL CHECKING**
 Duplicate board, carbonless tan check has 12 lines with "Pivot Points" and a "Menu Prompt" for better service. Lined back copy for beverages and a perforated receipt for the customer's record. A wrap-around cover prevents multicopy write-through. Shrink wrapped 8 bundles of 250 sets.
49205804 T4797SP 4 1/4" x 7 3/4", Tan 2000/cs.



G. GUEST CHECKS **NATIONAL CHECKING**
 Duplicate board, carbonless green check has 13 lines with a "Menu Prompt" for better service. Lined back copy for beverages and a perforated receipt for the customer's record. Versatile, duplicate copy guest check with first part green tint and second part white. Each check has a numbered customer receipt stub and may be used in a cash register.
49201920 G4797 4 1/8" x 7 1/4", Green 2000/cs.



H. GUEST CHECKS **NATIONAL CHECKING**
 Duplicate paper, carbonless white check has 13 lines with a "Menu Prompt" for better service. Original copy is printed in black and the duplicate in red. Cardboard wrap-around cover prevents multiple copy write-through. 50 sets per book, 100 book per case (shrink wrapped 10 bundles of 10 books).
49200101 101SP 3 2/8" x 5 5/8", White 5000/cs.

RESTAURANT, BAR & OFFICE SUPPLIES

Guest Checks/Cash Register Ribbon



A. GUEST CHECKS NATIONAL CHECKING

Duplicate board, carbonless tan check has 15 lines with "Pivot Points" and a "Menu Prompt" for better service. Lined back copy for beverages and a perforated receipt for the customer's record. A wrap-around cover prevents write-through and provides server tips for better service. Shrink wrapped 8 bundles of 250 sets.

49205816 T4997SP 4 1/4" x 8 1/2", Tan 2000/cs.

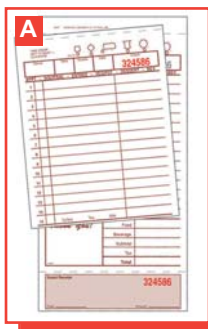

B. GUEST CHECKS NATIONAL CHECKING

Duplicate board, carbon-backed green check has 16 lines with "Pivot Points" and a "Menu Prompt" for better customer service. Lined back copy for beverages and a perforated receipt for the customer's record. Table settings on each check for proper food delivery.

49201924 G4900 4 1/8" x 8 1/4", Green, 2.5M Loose Sets 2500/cs.

49200010 G4900BK 4 1/8" x 8 1/4", Green, 50 Sets/Book, 50 Books/Case 2500/cs.



C. GUEST CHECKS NATIONAL CHECKING

Duplicate paper, carbonless green check has 17 lines with a "Menu Prompt" for better service. The kitchen copy is unlined and printed on yellow paper. A wrap-around cover prevents write-through and provides server tips for better service. 50 sets per book, 50 books per case.

49201936 G7000 3 2/5" x 6 3/4", Green 25000/cs.



D. GUEST CHECKS NATIONAL CHECKING

Triplicate board, carbonless tan Guestcheck™ has 15 lines with "Pivot Points" and a "Menu Prompt" for better service. Lined back copy for beverages and a perforated receipt for the customer's record. 2000 loose sets per case. Shrink packed 8 bundles of 250 sets.

49205814 T49973SP 4 1/8" x 8 1/2", Tan 2000/cs.

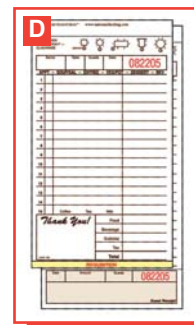

E. GUESTCHECK™ GUEST CHECKS NATIONAL CHECKING

Single board check has 15 lines with a "Menu Prompt" for better customer service. Lined back copy for beverages and a perforated receipt for the customer's record. 50 checks per book. May be used in a cash register.

49201908 G3632 3 1/2" x 6 3/4", Green 2500/cs.



F. GUESTCHECK™ GUEST CHECKS NATIONAL CHECKING

Duplicate paper, interleaving carbon green check has 17 lines with a "Menu Prompt" for better service. The kitchen copy is unlined. 50 sets per book, 50 books per case.

49201930 G6000 3 1/2" x 6 3/4", Green 2500/cs.



G. SALES BOOK NATIONAL CHECKING

Duplicate interleaving carbon, 11 lines. Original copy is printed in black and the duplicate in red. 50 sets per book, 100 books per case.

49207308 12ASP 3 1/2" x 5 5/8", White 5000/cs.



H. WAITRPAD® GUEST CHECKS NATIONAL CHECKING

Single paper white Waitpad® has 13 lines with "Pivot Points" and a "Menu Prompt" for better customer service. 100 checks per book/100 books per case.

49203516 3516SP 3 1/2" x 5 1/8" 10000/cs.



CASH REGISTER RIBBON/ROLLS

I. REGISTRIBBONS™ CASH REGISTER RIBBON NATIONAL CHECKING

Mainstays in any successful hospitality/service business. We supply a full line of cash register ribbons and thermal fax cartridges.

49203395 2433950 Epson ERC 30, 34, 38, Black/Red 6/cs.



RESTAURANT, BAR & OFFICE SUPPLIES

Cash Register Rolls/Paper/Rubber Bands/Tape



A. REGISTROLLS® CASH REGISTER & PRINTER ROLLS NATIONAL CHECKING One-Ply Bond Rolls

One-ply bond rolls. Utilized in a traditional cash register to generate a receipt of final charges for payment. Typically these registers require two rolls; one for the customer receipt, the other for internal record-keeping of the transaction. 10 rolls/tray.

49200037	1300SP	3" x 165", White, 3 Trays/Case	30/cs.
49200035	1441SP	44mm x 165', White, 5 Trays/Case	50/cs.

Two-Ply Bond Rolls

Two-ply white/canary bond paper, no carbon. Used in machines that verify the charges against a credit card and is used for the customer to sign. Copy one is kept by the restaurant and copy two is for the customer for their records. 10 rolls/tray.

49200041	2300SP	3" x 100', White/Canary, 3 Trays/Case	30/cs.
-----------------	--------	---------------------------------------	--------

One-Ply Thermal Rolls

One-ply, thermal. This heat sensitive roll produces a black image from a thermal printer. Utilized in kitchen printers or in a wait station printer to generate an itemized receipt of the customer's charges.

49200047	722580SP	2 1/4" x 80', White, 24 Rolls/Tray, 2 Trays/Case	48/cs.
49200044	7225SP	2 1/4" x 200', White, 10 Rolls/Tray, 4 Trays/Case	40/cs.
49200045	7313SP	3 1/8" x 200', White, 10 Rolls/Tray, 3 Trays/Case	30/cs.



B. THERMAL ROLLS NCR

Kiosk Rolls

Ensures trouble-free operation, and maximum performance.

49053115	513115	3 1/8" x 625", Swecoin TT7080	8/cs.
-----------------	--------	-------------------------------	-------

Regular Rolls

Regular thermal paper roll.

49059078	90780217	3 1/8" x 273'	50/cs.
-----------------	----------	---------------	--------



MULTI-USE PAPER

C. SPECTRUM® MULTI-USE PAPER GEORGIA-PACIFIC

Spectrum® multi-use paper has a 92 GE brightness rating. It is versatile and practical for daily use. Delivers quality performance in all copiers, fax machines, laser and ink jet printers. 500 sheets per ream.

13700100	999705	8 1/2" x 11", White, 20#	5000/cs.
13700151	999706	8 1/2" x 14", White, 20#	5000/cs.



D. WILLCOPY XEROGRAPHIC PAPER WEYERHAUSER

Premium #4 dual-purpose xerographic paper.

72820020	854001	8 1/2" x 14", White, 20#	5000/cs.
-----------------	--------	--------------------------	----------



RUBBER BANDS

E. PRIME SOURCE® RUBBER BANDS PRIME SOURCE®

Advantage rubber bands.

750002551	75000255	#33, 3 1/2" x 1/8", Red	1/cs.
75000255	75000255	#33, 3 1/2" x 1/8", Red	25/cs.

TAPE

F. SEAL-N-GO GENERAL PURPOSE CARTON SEALING TAPE INTERTAPE POLYMER GROUP

For light weight, non-critical, box sealing, package repair, and bundling applications.

39573250	1702	2" x 110 yd., Clear, 1.70 MIL	36/cs.
-----------------	------	-------------------------------	--------



G. COHERE 1060 CARTON SEALING TAPE SEKISUI TA

For sealing lightweight boxes subjected to minimal shipping hazards.

18781060	1060CLEAR2X110	2" x 110 yd., Clear, Supreme, 1.6 MIL	36/cs.
-----------------	----------------	---------------------------------------	--------

Tape/Bubble Wrap/Pallet Wrap



A. MASKING TAPE

SEKISUI TA

For splicing, most spray and brush painting masking applications, light bundling and packaging, protection in manufacturing. 5.1 MIL.

18782497 25012X60 2" x 60 yd. 24/cs.



BUBBLE WRAP

B. DURABUBBLE BUBBLE

POLYAIR CORPORATION

Durabubble has superior burst strength; bubbles withstand pressure and abuse. Maximum product protection. 100% recyclable, environmentally friendly. Tacky film surface so product does not move or slide when packed or during shipment. Good clarity makes product more visible. Excellent air retention. Good tensile strength. Superior puncture resistance. CFC-free; does not deplete the ozone layer.

55790259 DBS48500S12P12 3/16" Thick, 48" x 500', Perforated @ 48" 1/ea.



PALLET WRAP

C. PRIME SOURCE® PALLET WRAP

PRIME SOURCE®

Wrap has excellent puncture resistance and superior holding force. Remarkable stretch and cling characteristics allow for a fast, smooth application. Available in various widths.

Machine

75002735	75002735	20" x 5000', 19 MIC	1/ea.
75002736	75002736	20" x 6000', 18 MIC	1/ea.
75002737	75002737	20" x 6000', 19 MIC	1/ea.

Manual

75002711	75002711	12" x 1500', 80 GA	4/cs.
75002726	75002726	12" x 1500', 18 MIC	4/cs.
75002725	75002725	12" x 2000', 14 MIC	4/cs.
75002712	75002712	15" x 1500', 80 GA	4/cs.
75002728	75002728	15" x 1500', 18 MIC	4/cs.
75002727	75002727	15" x 2000', 14 MIC	4/cs.
75002710	75002710	16" x 1500', 65 GA	4/cs.
75002706	75002706	18" x 1500', 70 GA	4/cs.
75002713	75002713	18" x 1500', 80 GA	4/cs.
75002729	75002729	18" x 1500', 16 MIC	4/cs.
75002730	75002730	18" x 1500', 18 MIC	4/cs.
75002722	75002722	18" x 1500', 19 MIC	4/cs.



D. HW SERIES HANDWRAP

AEP INDUSTRIES

Blown hand wrap, with the flexibility and strength to meet all your applications requirements, this product is capable of stretching several hundred percent.

11201871 HW1870 18" x 1500', 70 GA 4/cs.



E. HC SERIES CONVENTIONAL HANDWRAP

INTEPLAST CORPORATION

A superior quality linear low-density polyethylene stretch film. A high performance cast hand wrap designed to secure irregular and difficult wrap load. A three-layer, cast, co-extruded film with cling on both sides.

03603831 HCB0601420 14" x 2000', 60 GA 4/cs.



F. SIGMA ECOSUPREME PREMIUM STRETCH FILM SIGMA STRETCH

Core extension. Lowest case cost. Ultra-lightweight. High load-holding capabilities. ecoSupreme is Sigma Stretch Film's newest, premium grade stretch film made with special orientation that produces stronger film at thinner gauges. Core extensions and ultra-lightweight rolls make ecoSupreme easy to handle and reduce wrapper fatigue. Engineered to outperform all competitive hand films regardless of gauge. Reinforced edges to provide unrivaled load-holding force and tear resistance. Aggressive cling package is strong enough for B and many C loads. Using less film per load makes ecoSupreme eco-friendly.

64311650 HPE1615ECO2 15 1/2" x 1476', 10 MIC 4/cs.

64310019 HPE1615ECO 16" x 1500', 10 MIC 4/cs.



Pallet Wrap/Twine/Paper Cutter/Cutters/Blades



RESTAURANT, BAR & OFFICE SUPPLIES



A. SIGMA SUPREME HAND FILM SIGMA STRETCH

Low case cost. A premium grade film made with special orientation for a stronger film at thinner gauges. Roll is lightweight and easy to use, which minimizes wrapper fatigue even for persons of small stature. Less film per load also equals less stress on the environment.
64311557 *HPB181557* 18" x 1500', .57 MIL 4/cs.

TWINE

B. PRIME SOURCE® BUTCHER'S TWINE PRIME SOURCE®

Cotton/polyester blend.

75000201	<i>75000202</i>	12-Ply, 1/2 lb. Ball	1/ea.
75000202	<i>75000202</i>	12-Ply, 1/2 lb. Ball	96/cs.
750002001	<i>75000200</i>	12-Ply, 2 lb. Cone	1/ea.
750002031	<i>75000203</i>	16-Ply, 2 lb. Cone	1/ea.
75000203	<i>75000203</i>	16-Ply, 2 lb. Cone	25/cs.
750002041	<i>75000204</i>	16-Ply, 5 lb. Cone	1/ea.
750002061	<i>75000206</i>	20-Ply, 2 lb. Cone	1/ea.
75000206	<i>75000206</i>	20-Ply, 2 lb. Cone	25/cs.
75000208	<i>75000208</i>	24-Ply, 8 oz. Ball	96/cs.
750002091	<i>75000209</i>	24-Ply, 2 lb. Cone	1/ea.
75000209	<i>75000209</i>	24-Ply, 2 lb. Cone	25/cs.
750002211	<i>75000221</i>	#60, 1 lb. Ball	1/ea.



PAPER CUTTER

C. STANDARD ALL-IN-ONE ROLL PAPER CUTTER BULMAN PRODUCTS

Smoothly dispenses many types of paper including butcher, kraft, and gift-wrapping papers. It cuts evenly, using either side of the double-edged, spring-loaded blade. Holds up to 9" diameter roll. Roll changing is easy with dowel holders and knife arms that lock into open position. Mounts permanently on a wall, under a counter or on a countertop.
23302718 *A50018* 18" 1/ea.



CUTTERS/BLADES

D. SAFETY HOLSTER PACIFIC HANDY CUTTER

The perfect companion for the S4 Safety Cutter. By positioning the S4 Safety Cutter with the button facing inward, the holster will automatically retract any exposed blade.
541510071 *UKH423* 1/ea.



E. REPLACEMENT BLADES PACIFIC HANDY CUTTER

Handy Safety Point Blade® for use in S4 Safety Cutters, RZ3, and EZ3.
541510065 *SP017* 100 ct., 1 3/4", 0.017 Thickness 100/cs.

F. RETRACTABLE UTILITY KNIVES RUBBERMAID

Optimized cutting angle for reduced fatigue. Smooth, three-position slide exposes variable blade length and increased durability for frequent use. Inside storage for 5 blades.
17709006 *9H06* 6 3/4"L, Silver, Quick Change 1/ea.
17709007 *9H07* 6 3/4"L, Red, Self-Retracting 1/ea.
17709005 *9H05* 6 3/4"L, Standard, Red 1/ea.



G. BLADE DISPENSER W/REFILLS RUBBERMAID

Blades are unbreakable under normal working conditions. Optimized cutting angle for reduced fatigue. Smooth, three-position slide exposes variable blade length and increased durability for frequent use. Inside storage for 5 blades. Blades stay sharp three times longer than conventional blades.
17702084 *2084300* 50 Refill Blade Dispenser, 1 1/8"H x 4 1/2"L, Blue 5/cs.
17708440 *2084400* 100 Blades, 1 1/8"H x 4 1/2"L, Blue 5/cs.



Cocktail/Beverage & Dispenser/Luncheon Napkins

COCKTAIL/BEVERAGE NAPKINS

A. BEVERAGE NAPKINS PRIME SOURCE®

High quality, value priced napkins ideal for all public environments.

Prime Source®

75004381	75004381	4 ⁷ / ₁₀ " x 4 ⁷ / ₁₀ ", 1-Ply	8/500/cs.
75004380	75004380	4 ⁷ / ₁₀ " x 4 ⁷ / ₁₀ ", 1-Ply	4/1000/cs.
Hi-Valu			
73004380	73004380	9" x 9", 1/4-Fold, White, 1-Ply	4000/cs.

B. BEVERAGE NAPKINS HOFFMASTER

These napkins have decorative inner packs that are completely overwrapped in poly to keep napkins clean and sanitary. The decorative sleeves are also perfect for catering events, they look great and the napkins dispense easily. Oak leaf embossed.

17800081	020389	10" x 10", Black, 2-Ply	1000/cs.
17801065	056246	10" x 10", White, 2-Ply	3000/cs.

C. MARCAL PRO™ 100% PREMIUM RECYCLED BEVERAGE NAPKIN MARCAL PAPER MILLS

Made with a minimum of 60% post-consumer content. Meets or exceeds EPA guidelines for post-consumer content. Whitened without chlorine bleaching. No dye or fragrance added. Virtually lint-free.

15700028	0028	9 ¹ / ₄ " x 9 ¹ / ₂ ", 2-Ply, 500 ct.	4000/cs.
----------	------	---	----------

D. TORK® BEVERAGE NAPKINS SCA TISSUE

Advanced

Facial grade napkins that provide a superior look and feel to other beverage napkins. Box packaging ensures perfect product quality and protection. Disposal is simple and convenient. Napkins are always fresh and sanitary. Made from 100% recycled fiber. EcoLogo® Certified.

14101241	B1241A	9 ¹ / ₄ " x 9 ¹ / ₄ ", 1/4 Fold, White, 2-Ply, 300 ct.	3000/cs.
----------	--------	--	----------

Universal

Embossed semi-crepe texture gives a higher-quality feel. Inexpensive and perfect for high-volume applications. Special poly-bag packaging ensures perfect product quality and protection for unused napkins. Napkins are always fresh and sanitary, unlike multi-use coasters. Made from 100% recycled and 20% post-consumer fibers. EcoLogo® Certified. Compostable Verified by BPI and Independent Verification.

14101143	B1141A	9 ² / ₅ " x 9 ² / ₅ ", White, 1-Ply	8/500/cs.
14101141	B1141A	9 ² / ₅ " x 9 ² / ₅ ", White, 1-Ply	4000/cs.

DISPENSER/LUNCHEON NAPKINS

E. DISPENSER NAPKINS PRIME SOURCE®

Prime Source®

High quality, value priced napkins that offer absorbency, strength and cleanliness.

75004379	75004379	6" x 13 ¹ / ₂ ", Tall Fold, White, 1-Ply	10000/cs.
75004384	75004384	7" x 12", Tall Fold, White, 1-Ply	8000/cs.
75004383	75004383	7" x 12", Tall Fold, White, 1-Ply	10000/cs.
75004385	75004385	8 ⁷ / ₁₁ " x 12", Low Fold, White, 1-Ply	8000/cs.
75004387	75004387	12" x 13", Economy Fold, White, 1-Ply	6000/cs.
75004386	75004386	12" x 13", White, 1-Ply	6000/cs.

Green Source™

100% recycled. Chlorine-free. EcoLogo® Certified. Trilingual packaging (English, Spanish, French).

75009550	75009550	Low Fold, White, 1-Ply	6000/cs.
75009545	75009545	Tall Fold, White, 1-Ply	7500/cs.

Hi-Valu

High quality napkins that are value priced. Ideal for all public environments.

73002654	73002654	7" x 11 ⁴ / ₅ ", Low Fold, White, 1-Ply	10000/cs.
73004383	73004383	7" x 13", Tall Fold, White, 1-Ply	8000/cs.
73004385	73004385	11 ¹ / ₄ " x 13", 1/4 Fold, White, 1-Ply	6000/cs.

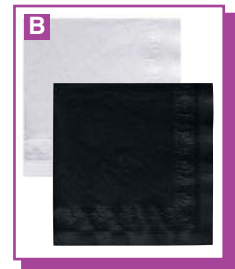

Dispenser/Luncheon Napkins



A. NAPKINS GEORGIA-PACIFIC

Acclaim® Low Fold Dispenser Napkin

Small dispenser napkin for limited-menu service operations. Designed to be used with TidyNap® low fold table and cafeteria napkin dispensers.

13707925 39201 9" x 12", White, 1-Ply, 250 ct. 8000/cs.

Acclaim® Luncheon Napkin

Luncheon napkin in convenient, protective, poly-packaging provides reliable performance at an economical price.

13707707 37707 11½" x 12½", White, 500 ct. 6000/cs.

Acclaim® Mini-MorNap® Dispenser Napkin

Economical, mini full-fold large dispenser napkin solution for all quick-service operations.

13703822 37000 12" x 13", White, 500 ct. 6000/cs.

Acclaim® Tall Fold Dispenser Napkin

Economy tall fold dispenser napkin that is a low cost small dispenser napkin for limited-menu service restaurants. Designed to be used with HyNap® tall fold, open-faced napkin dispensers.

13707930 33201 7" x 13½", White, 1-Ply, 250 ct. 10000/cs.

EasyNap® Dispenser Napkin

Embossed multi-layer napkin for the EasyNap™ high capacity system. One-at-a-time napkin dispensing reduces napkin usage by up to 30% and improves operational efficiency with fewer refills, reduced run-out risk, and less required storage space.

13703220 32002 6½" x 9⅞", White, 250 ct. 24/cs.

MorNap® Dispenser Napkin

Full fold, large dispenser napkin that provides a solution for all quick-service operations. Designed to fit high-capacity MorNap® dispensers.

13707402 37402 12" x 17", White, 1-Ply, 500 ct. 6000/cs.

MorNap® Jr® Dispenser Napkin

Economical, full-fold large dispenser napkins help reduce operating costs by reducing napkin size and utilizing large dispenser napkin dispensers.

13700121 37803 13" x 12", White, 600 ct. 12/600/cs.

B. DISPENSER NAPKINS KIMBERLY-CLARK

Dispenser Napkin

Soft, absorbent, dispenser napkin with cross-hatched embossing.

15409871 98710 7" x 13½", Tall Fold, White, 1-Ply, 250 ct. 10000/cs.

Scott® Dispenser Napkins

Soft, absorbent, dispenser napkins.

15408720 98720 7" x 12", Tall Fold, White, 1-Ply, 250 ct. 8000/cs.

15408730 98730 12" x 17", Full Fold, White, 1-Ply, 250 ct. 6000/cs.

Scott® Megacartridge Napkin

The perfect solution to napkin overuse. One-at-a-time dispensing for reduced consumption. Easy loading and high capacity.

15409890 98908 6½" x 8⅝", White, 875 ct. 5250/cs.

C. SMALL STEPS® 100% PREMIUM RECYCLED LUNCHEON NAPKIN MARCAL PAPER MILLS

Made with a minimum of 60% post-consumer content. Meets or exceeds EPA guidelines for post-consumer content. Packed in a unique Draw & Store® bag. Great for break room and luncheon areas. Keeps napkins neat, clean and organized. Whitened without chlorine bleaching. No dye or fragrance added. Virtually lint-free.

15706507 6506 13" x 11¼", White, 1-Ply, 400 ct. 2400/cs.

D. DISPENSER NAPKIN PRINCESS PAPER

One-ply dispenser napkin.

75980501 PC501 7" x 13½" 20/500/cs.

Dispenser/Luncheon Napkins



A. BOUNTY® EVERYDAY NAPKINS PROCTER & GAMBLE

Bounty quilted napkins provide you with the strength you've come to trust. Each napkin is single-ply.

16904884 34884 12" x 12", White, 1-Ply 2000/cs.



B. DISPENSER NAPKINS ROSES SOUTHWEST PAPER

Dispenser napkins.

59341311 31311 13" x 12", Bleached, 1-Ply, 200 ct. 6000/cs.



C. TORK® ADVANCED NAPKINS SCA TISSUE

Dispenser Napkins

Facial quality enhances feel and absorbency more than usual single-ply service dispenser napkins. An SCA exclusive. Largest open and folded size dispenser napkin making it a good value, fewer napkins needed per serving. Keeps cost down. Bag packaging ensures superior product quality while protecting unused napkins. Always fresh and sanitary. Made from 100% recycled and 20% post-consumer fibers offers environmental benefits. A positive image builder. Compostable. EcoLogo® Certified. Compostable Verified by BPI and Independent Verification.

14100826 D826E 13" x 12", Luxri 13, Natural, 1-Ply, 500 ct. 6000/cs.
 14100820 D820 13" x 12", Luxri 13, White, 1-Ply, 500 ct. 6000/cs.
 14100806 D806E 13" x 12", Luxri 17, Natural, 1-Ply, 500 ct. 6000/cs.
 14101802 D802A 13" x 12", Luxri 17, White, 1-Ply, 500 ct. 6000/cs.

RollNap Dispenser Napkin

By allowing patrons to take only one napkin at a time, the RollNap napkin dispensing system reduces consumption by up to 25%. This results in a substantial reduction in your overall napkin cost. The hygienic pull and tear system allows customers to touch only the napkins they use. Made from 100% recycled and 20% post-consumer fibers. Offers environmental benefits. A positive image builder. Compostable.

14107049 DR7050A 9" x 17", White, 1-Ply, 500 ct. 6000/cs.

XpressNap® Cafe Dispenser Napkins

The one-at-a-time napkin dispensing design ensures that patrons use fewer napkins and touch only the napkin they use improving personnel hygiene. Plus, one-at-a-time dispensing helps decrease consumption, so you'll reduce the number of cases you need to store. One napkin-at-a-time dispensing provides up to a 25% reduction in napkin usage. Inner bag packaging ensures superior product quality while protecting unused napkins. Made from 100% recycled fibers, 90% post-consumer content, using a bleach-free process. Meets EPA guidelines for post-consumer content (minimum 40% post-consumer content). Offers environmental benefits. A positive image builder.

14102902 DX606E 8 1/2" x 8 1/2", Natural, 1-Ply 6000/cs.
 14102901 DX600 8 1/2" x 8 1/2", White, 1-Ply 6000/cs.

XpressNap® Interfold Dispenser Napkin

Dramatically reduces napkin usage. Its one-at-a-time napkin dispensing design ensures that patrons use fewer napkins and touch only the napkin they use improving personnel hygiene. XpressNap® napkins are larger than major competitor interfolded napkins offering strength, absorbency and quality to users. Made from 100% recycled and 20% post-consumer fibers. Offers environmental benefits. A positive image builder. Compostable. EcoLogo® Certified.

14102900 DX900 13" x 8 1/2", White, 1-Ply, 500 ct. 6000/cs.



Dispenser/Luncheon & Dinner Napkins



A. TORK® UNIVERSAL NAPKINS

SCA TISSUE

Dispenser Napkins

The embossing and semi-crepe texture gives a quality feel. Bag packaging ensures superior product quality while protecting unused napkins. Made from 100% recycled and 20% post-consumer fibers offer environmental benefits. A positive image builder. Compostable. Environmental Choice EcoLogo® Certified. Compostable Verified by BPI and Independent Verification.

14106313	<i>D6311A</i>	5½" x 12", Thrifty Daintifold, White, 1-Ply, 334 ct.	8016/cs.
14103058	<i>D3056B</i>	6" x 13½", Betsy Tall Fold, Natural, 1-Ply, 625 ct.	10000/cs.
14100191	<i>D3052B</i>	6" x 13½", Betsy Tall Fold, White, 1-Ply, 625 ct.	10000/cs.
14103060	<i>D3061A</i>	8⅞" x 12", Daintifold Low Fold, White, 1-Ply, 250 ct.	8000/cs.
14100786	<i>D786E</i>	13" x 12", Masterfold, Natural, 1-Ply, 500 ct.	6000/cs.
14100780	<i>D780</i>	13" x 12", Masterfold, White, 1-Ply, 500 ct.	6000/cs.

Luncheon Napkin

Embossed semi-crepe texture that provides a higher-quality feel and better absorbency. This medium sized luncheon napkin is perfect for food service operations serving light meals. Napkins are always fresh and sanitary. Made from 100% recycled and 20% post-consumer fibers. EcoLogo® Certified. Compostable Verified by BPI and Independent Verification.

14103141	<i>L3141</i>	13" x 11½", 1/4 Fold, White, 1-Ply, 500 ct.	6000/cs.
-----------------	--------------	---	----------

XpressNap® Environmental Print Dispenser Napkin

This Environmental Printed XpressNap® Dispenser Napkin makes it easy for you to show your customers that you care about the environment. The green messages ring true on a 100% recycled (90% post-consumer), EcoLogo® Certified natural napkin, ("Save the environment, one napkin at a time" and "Made with 100% recycled material"). Its one-at-a-time napkin dispensing design ensures that patrons use fewer napkins and touch only the napkin they use, improving personnel hygiene. Environmental Choice EcoLogo® Certified.

14100908	<i>908EX</i>	8½" x 13", 1/4 Fold, Natural w/Printed Messages, 1-Ply, 500 ct.	6000/cs.
-----------------	--------------	---	----------

XpressNap® Interfold Dispenser Napkin

The Tork Universal XpressNap® system dramatically reduces napkin usage. Its one-at-a-time napkin dispensing design ensures that patrons use fewer napkins and touch only the napkin they use improving personnel hygiene. Plus, one-at-a-time dispensing helps decrease consumption, so you'll reduce the number of cases you need to store. XpressNap® napkins are larger than major competitor interfolded napkins offering strength, absorbency and quality to users. Made from 100% recycled fiber and a bleach-free process and 90% post-consumer content. Meets EPA guidelines for post-consumer content (Minimum 40% post-consumer content) offers environmental benefits and a positive image. Compostable. EcoLogo® and Green Seal™ Certified. Compostable Verified by BPI and Independent Verification.

14100901	<i>DX906E</i>	8½" x 13", Natural, 1-Ply, 500 ct.	6000/cs.
-----------------	---------------	------------------------------------	----------

DINNER NAPKINS

B. DINNER NAPKINS

PRIME SOURCE®

High quality, value priced napkins that offer absorbency, strength and cleanliness.

Prime Source®

75004388	<i>75004388</i>	15" x 17", 1/8-Fold, White, 1-Ply	3000/cs.
75004389	<i>75004389</i>	15" x 17", White, 1-Ply	5000/cs.
75004303	<i>75004303</i>	15" x 16¼", 1/8-Fold, White, 2-Ply	3000/cs.
75004390	<i>75004390</i>	15" x 17", White, 2-Ply	3000/cs.

Green Source™

100% recycled. Chlorine-free. EcoLogo® Certified. Trilingual packaging (English, Spanish, French).

75009540	<i>75009540</i>	15" x 17", 1/8 Fold, White, 2-Ply	2600/cs.
-----------------	-----------------	-----------------------------------	----------

Hi-Valu

High quality napkins that are value priced. Ideal for all public environments.

73004397	<i>73004397</i>	15" x 17", 1/8 Fold, White, 1-Ply	5000/cs.
73004395	<i>73004395</i>	17" x 17", 1/4 Vertical, Embossed, White, 1-Ply	4000/cs.
73004390	<i>73004390</i>	15" x 17", 1/8 Fold, White, 2-Ply	3000/cs.
73004391	<i>73004391</i>	15" x 17", 1/8 Fold, Embossed, White, 2-Ply	3000/cs.
73004393	<i>73004393</i>	15" x 17", 1/8 Fold, Side-By-Side, White, 2-Ply	3000/cs.
73004392	<i>73004392</i>	15" x 17", 1/8 Straight, Embossed, White, 2-Ply	3000/cs.
73004394	<i>73004394</i>	17" x 17", 1/8 Straight, Embossed, White, 2-Ply	3000/cs.



Dinner Napkins



A. DINNER NAPKINS GEORGIA-PACIFIC

Crown®

Economical dinner napkins for value-oriented full-service restaurants.

13701578 31578 15" x 17", 1/8 Fold, White, 1-Ply, 150 ct. 3000/cs.

Essence®

Fine paper linen napkins offer the ultimate linen replacement at a fraction of the cost.

13700134 92117 17" x 17", 1/8 Fold, White, 100 ct. 400/cs.

Preference®

These popular, soft and absorbent napkins offer your patrons more in a napkin, which means they use fewer napkins and you save more money. Our simple, elegant design makes them ideal for better restaurants, resorts, lodging, office buildings, and healthcare facilities. Brown napkins meet or exceed EPA Comprehensive Procurement Guidelines for minimum post-consumer fiber content.

13700123 31437 15" x 17", 1/8 Fold, Brown, 2-Ply, 250 ct. 3000/cs.

13700115 31436 15" x 17", 1/8 Fold, White, 2-Ply, 100 ct. 3000/cs.



B. DINNER NAPKINS HOFFMASTER

Decorator

Oak leaf embossed dinner napkin.

17801598 020517 15" x 17", 1/8 Fold, Ecru, 2-Ply 1000/cs.

Linen-Like®

A high quality, convenient replacement for linen, and this premium disposable dinner napkin is patron preferred. One napkin lasts an entire meal. Greek key embossed.

17800202 120051 17" x 17", White 300/cs.

Linen-Like® Flat Pack

This premium disposable linen-like product comes in a unique, crease-free Flat Pack. The Linen-Like® Flat Pack is a poly packaged, sanitary and convenient foodservice product. The Flat Pack will actually save you labor costs as the product is ready to fold, fluff, wrap, drape or accent a centerpiece.

17805023 125023 16" x 16", White 1000/cs.



C. SCOTT® DINNER NAPKINS KIMBERLY-CLARK

Strong and economical napkins perfect for business or home. Made from 65% recycled fiber content and 50% post-consumer waste content.

15408200 98200 14⁷/₁₆" x 17", 1/8 Fold, White, 2-Ply, 300 ct. 3000/cs.

15409838 98380 17" x 17", 1/8 Fold, White, 3-Ply, 200 ct. 2000/cs.



D. MARCAL PRO™ 100% PREMIUM RECYCLED BELLA® DINNER NAPKINS MARCAL PAPER MILLS

Made with a minimum of 60% post-consumer content. Meets or exceeds EPA guidelines for post-consumer content. Whitened without chlorine bleaching. No dye or fragrance added.

15702121 0212101 17" x 15" 3000/cs.



E. ROSES DINNER NAPKINS ROSES SOUTHWEST PAPER

Bleached dinner napkins.

59340205 30205 15" x 17", White, 2-Ply 3000/cs.

59340305 30305 17" x 17", White, 3-Ply 2000/cs.



Dinner Napkins/Napkin Bands & Dispensers

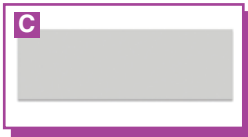

A. TORK® ADVANCED DINNER NAPKINS SCA TISSUE

This economical napkin is ideal for high-volume applications. Exclusive tall fold styling allows silverware to rest on it with little or no overhang. Bag packaging ensures superior product quality while protecting unused napkins. Napkins are always fresh and sanitary. Made from 100% recycled fiber, it offers environmental benefits and is a positive image builder. EcoLogo® Certified.

14102000	<i>NP310A</i>	15" x 16 1/4", 1/8 Fold, White, 2-Ply, 375 ct.	3000/cs.
The Sea Shell embossing and facial quality napkins that bring class and practicality to casual dining. High brightness provides a quality look. 1/4 fold design offers quick and easy wrapping of cutlery. Made from 100% recycled fiber. Environmental Choice EcoLogo® Certified.			
14105241	<i>NP5240C</i>	15" x 16 1/4", 1/4 Fold, White, 2-Ply, 375 ct.	3000/cs.
Embossed napkin that offers a quality look and hand feel. Poly wrapped packaging protects napkin quality and ensures perfect presentation every time. These napkins are always fresh and sanitary. Made from 100% recycled and 20% post-consumer fibers. Offers environmental benefits. A positive image builder. EcoLogo® Certified.			
14101528	<i>NP528PA</i>	15" x 17", 1/8 Fold, White, 2-Ply, 100 ct.	2800/cs.
This embossed, facial quality napkin has advantages over cloth: absorbency, never frayed, uniform presentation, cleanliness and especially cost savings. The tasteful rose embossing combined with three-ply thickness and high brightness provides for a quality look and hand feel. Made from 100% recycled fiber. EcoLogo® Certified.			
14107340	<i>NP7340A</i>	17" x 16 1/8", 1/4 Fold, White, 3-Ply, 250 ct.	2000/cs.
14102001	<i>NP7380A</i>	17" x 16 1/8", 1/8 Fold, White, 3-Ply, 290 ct.	1740/cs.

B. TORK® UNIVERSAL DINNER NAPKINS SCA TISSUE

Embossed facial quality texture provides a higher-quality feel and better absorbency. Inexpensive alternative to multi-ply facial. Perfect for high-volume applications. Made from 100% recycled fiber. EcoLogo® Certified. Compostable Verified by BPI and Independent Verification.

14105140	<i>N5140A</i>	15" x 17", 1/4 Fold, White, 1-Ply, 334 ct.	3000/cs.
14105142	<i>N5140A</i>	15" x 17", 1/4 Fold, White, 1-Ply, 334 ct.	4008/cs.
14107142	<i>N7141A</i>	17" x 17", 1/4 Fold, White, 1-Ply, 334 ct.	4008/cs.
14102003	<i>N5183A</i>	15" x 16 1/4", 1/8 Fold, White, 1-Ply, 500 ct.	2000/cs.
14102006	<i>N5181A</i>	15" x 17", 1/8 Fold, White, 1-Ply, 250 ct.	3000/cs.

NAPKIN BANDS

C. NAPKIN BANDS HOFFMASTER

Paper napkin bands.

18104500	<i>154500</i>	1 1/2" x 4 1/2", White	20000/cs.
-----------------	---------------	------------------------	-----------

NAPKIN DISPENSERS

D. TALL-FOLD TABLETOP NAPKIN DISPENSERS SAN JAMAR

Easy loading, two-sided tall-fold dispenser. Design allows visibility of printed napkin logo.

62578001	<i>H900BK</i>	150 Napkins, 7 1/2" x 3 3/4" x 4", Black	1/ea.
62579011	<i>H900X</i>	150 Napkins, 7 1/2" x 3 3/4" x 4", Stainless Steel	12/cs.

E. TORK® XPRESSNAP® CLASSIC SCA TISSUE STAND NAPKIN DISPENSER

Since 2003 Tork Xpressnap® Classic has served up built-in value from foodservice counters across the country. Xpressnap Classic greatly increases personal hygiene and cuts waste by delivering one napkin at a time, every time. SCA Tissue guarantees a 25% reduction in napkin usage although actual results often show savings as high as 40%. The Xpressnap® Stand model provides stability and holds the dispenser upright. Its portable feature allows the user to easily position the unit at any location. Holds up to 900 napkins, nearly three times the capacity of traditional dispensers, producing additional savings in labor. The unique Ad-a-Glance message panel can be used for in-store promotions or to generate advertising revenue. First introduced in 2004, the Xpressnap® system has taken the foodservice industry by storm and has earned international recognition for innovation and excellence.

14100035	<i>32XPS</i>	900 Napkins, 19 1/2"H x 8"W x 5 5/8"D, Clear/Black	1/ea.
-----------------	--------------	--	-------

Napkin Dispensers/Towelettes/Doilies/Placemats



A. TORK® XPRESSNAP® TABLETOP NAPKIN DISPENSER SCA TISSUE

Increase hygiene and cut waste by delivering one napkin at a time. Customers touch only the napkins they take and take only what they use. Ad-a-Glance message panels that can be used for in-store promotions or to generate ad revenue. Holds 200 napkins.

141000271	<i>32XPT</i>	200 Napkins, 6 ¹ / ₅ "H x 5 ⁴ / ₅ "W x 7 ⁴ / ₅ "D, Clear/Black	1/ea.
14100027	<i>32XPT</i>	200 Napkins, 6 ¹ / ₅ "H x 5 ⁴ / ₅ "W x 7 ⁴ / ₅ "D, Clear/Black	4/cs.



MOIST TOWELETTES

B. WET-NAP® MOIST TOWELETTES SANI PROFESSIONAL

Pre-moistened towelettes for convenient clean-up when soap and water are not available. Fresh lemon scent. Does not contain alcohol.

49681100	<i>D11000</i>	7 ³ / ₄ " x 5", Boxed, 100 ct.	1000/cs.
49686505	<i>D11055</i>	7 ³ / ₄ " x 5", Polybagged, 100 ct.	10/100/cs.



DOILIES

C. CAMBRIDGE LACE DOILIES HOFFMASTER

Doilies convey a quality image, allowing you to more effectively merchandise appetizers, desserts and menu specialties.

17800145	<i>500233</i>	4" dia., White	1000/cs.
17800142	<i>500234</i>	5" dia., White	1000/cs.
17800132	<i>500235</i>	6" dia., White	1000/cs.
17800131	<i>500236</i>	8" dia., White	1000/cs.
17800137	<i>500238</i>	10" dia., White	1000/cs.
17800146	<i>500239</i>	12" dia., White	1000/cs.



D. FRENCH LACE DOILIES HOFFMASTER

Ideal for decorative purposes. Designed to be disposed after one use.

18107905	<i>301015</i>	5" dia., White	10000/cs.
18107910	<i>301016</i>	6" dia., White	10000/cs.
18107920	<i>301018</i>	8" dia., White	5000/cs.
18107925	<i>3010110</i>	10" dia., White	5000/cs.



TRAY COVER/PLACEMATS

E. CLASSIC IMPRESSIONS™ TRAY COVER GEORGIA-PACIFIC

Economy white tray cover. Mediumweight. One-ply.

13709460	<i>87012</i>	16 ³ / ₈ " x 12 ³ / ₄ ", White	6/cs.
-----------------	--------------	--	-------



F. EMBOSSED PLACEMAT HOFFMASTER

Straight edge placemat.

18107950	<i>30659</i>	10" x 14", White	1000/cs.
-----------------	--------------	------------------	----------

G. ECONOMY PLACEMAT HOFFMASTER

Scalloped edge. 100% recycled.

17809525	<i>310524</i>	9 ¹ / ₂ " x 13 ¹ / ₂ ", Burgundy	1000/cs.
-----------------	---------------	--	----------



NAPKINS, PLACEMATS & TABLE COVERS

Table Covers



TABLE COVERS

A. PRIME SOURCE® TABLE COVER

PRIME SOURCE®

Embossed plastic table cover roll.

76000075 76000075 40" x 300', White, Plastic

1/rl.



B. CELLUTEX® DECORATOR TABLE COVERS

HOFFMASTER

Two-ply tissue, one-ply poly table cover.

17805465 210046 54" x 54", Dinner, White

50/cs.

17801083 220622 54" x 108", Banquet, Navy

25/cs.

17801086 210130 54" x 108", Banquet, White

25/cs.



C. TABLE COVER

HOFFMASTER

One-ply paper roll table cover.

17800043 260045 40" x 300', Bright White

1/rl.



D. TORK® PREMIUM FOLDED TABLE COVER

SCA TISSUE

Tork® Premium folded table covers have a sturdy poly backing that protects from spills. Soft two-ply tissue delivers the softness and drape of cloth. Disposable for quick and easy cleanup that helps reduce costs.

14100529 540TW 54"W x 108"L, White, 3-Ply

20/cs.

Hinged Paper Containers



HINGED PAPER CONTAINERS

A. HINGED CONTAINERS BRIDGE-GATE ALLIANCE GROUP

Premium hingeware made from renewable resources. Biodegradable and compostable. FDA approved for food use. Grease and water resistant. Microwaveable. BPI certified.

B7280100	<i>BG6HW</i>	6"	500/cs.
B7280101	<i>BG8HW</i>	8"	200/cs.
B7280102	<i>BG83HW</i>	8", 3-Compt.	200/cs.
B7280103	<i>BG9HW</i>	9"	200/cs.
B7280104	<i>BG93HW</i>	9", 3-Compt.	200/cs.
B7280107	<i>BGHOAGIE</i>	Hoagie	250/cs.



B. HINGED CONTAINERS BRIDGE-GATE ALLIANCE GROUP

Compostable serving ware. Molded fiber pulp product with environmentally advanced technologies, conserving energy and water. Starting with the purest raw materials, the natural byproducts of agricultural waste, Bridge-Gate employs a proprietary, self-contained washing and Biopulping process, minimizing ecological impact from field to factory to foodservice. With Bridge-Gate, you and your customers can be assured of compostable, consistently top-quality products that have been produced with the utmost concern for the environment.

B7280200	<i>ECO6HW</i>	6"	4/100/cs.
B7280201	<i>ECO8HW</i>	8"	2/100/cs.
B7280202	<i>ECO83HW</i>	8", 3-Compt.	2/100/cs.
B7280203	<i>ECO9HW</i>	9"	2/100/cs.
B7280204	<i>ECO93HW</i>	9", 3-Compt.	2/100/cs.
B7280065	<i>ECO103HW</i>	10", 3-Compt.	200/cs.
B7280205	<i>ECOHOAGIE</i>	Hoagie	2/125/cs.



C. SUGARCANE CLAMSHELLS ECO-PRODUCTS

Certified compostable by Biodegradable Products Institute (BPI), a third-party agency. Grease and cut resistant, plus microwave and freezer safe. Grooved lids allow stacking. Double tab snap closures.

C6670034	<i>EPHC6</i>	6" x 6" x 3"	500/cs.
C6670033	<i>EPHC91</i>	9" x 9" x 3"	200/cs.



D. HINGED CONTAINER HUHTAMAKI

Bagasse clamshell.

15300449	<i>68003</i>	8" x 8" x 3", 1-Compt.	200/cs.
-----------------	--------------	------------------------	---------

E. NATURE FRIENDLY® CLAMSHELL CONTAINERS NATURE FRIENDLY PRODUCTS

Nature Friendly Products' 100% biodegradable and compostable tableware provides consumers with an eco-friendly alternative to traditional disposables. Made from sugar cane bagasse-based renewable resources, they are completely compostable within 50-100 days in home and commercial composting facilities. Superior in strength and performance.

Non-toxic, hot/cold tolerant, oil and water resistant, microwave and freezer safe.

C6933003	<i>B003</i>	5" x 5"	250/cs.
C6933004	<i>B024</i>	5" x 5", Hamburger	250/cs.
C6933001	<i>B001</i>	7 1/2" x 5", Lunch Box	250/cs.
C6933009	<i>B110</i>	8" x 8"	250/cs.
C6933012	<i>B118</i>	8" x 8", 3-Compt.	200/cs.
C6933002	<i>B002</i>	9" x 5 1/2", 2-Partition Box	500/cs.
C6933007	<i>B025</i>	9" x 9"	200/cs.
C6933013	<i>B119</i>	10" x 10"	250/cs.
C6933010	<i>B111</i>	10" x 10", 3-Compt.	250/cs.



Hinged & Non-Hinged Paper Containers



A. EARTHCHOICE® FIBER BLEND HINGED LID CONTAINERS PACTIV

Social responsibility, respect and care for the environment require action today while keeping an eye to the future. Meet the ASTM D 6868 Standards for Compostability. These products are made from sustainable, renewable materials. Made of a blend of fiber and pulp materials. Double tab lock keeps container securely closed. All natural white provides a brilliant, white exterior. Stackable. Soak through resistant design resists grease, moisture and helps eliminate messy leaks. Made in the USA.

16200422	<i>MCH0080</i>	6" x 6" x 2 ¹ / ₃ ", Sandwich 1-Compt.	500/cs.
16200357	<i>MCH0801</i>	8 ¹ / ₉ " x 8 ¹ / ₉ " x 2 ¹ / ₉ ", Medium 1-Compt.	200/cs.
16200355	<i>MCH0803</i>	8 ¹ / ₉ " x 8 ¹ / ₉ " x 2 ¹ / ₉ ", Medium 3-Compt.	200/cs.
16200359	<i>MCH0089</i>	9" x 6 ¹ / ₅ " x 3", Utility 1-Compt.	200/cs.
16200353	<i>MCH0901</i>	9 ¹ / ₅ " x 8 ³ / ₄ " x 2 ¹ / ₂ ", Large 1-Compt.	200/cs.
16200352	<i>MCH0903</i>	9 ¹ / ₅ " x 8 ³ / ₄ " x 2 ¹ / ₂ ", Large 3-Compt.	200/cs.

NON-HINGED PAPER CONTAINERS

B. PRIME SOURCE® ENVY® PAPER FOOD CONTAINER COMBOS

PRIME SOURCE®

For all types of hot or cold foods. Extra-rigid, poly-lined inside and out. Sturdy, snug-fit spiral wound paper lids.

75002083	<i>75002083</i>	8 oz., w/Lid	250/cs.
75002085	<i>75002085</i>	12 oz., w/Lid	250/cs.
75002087	<i>75002087</i>	16 oz., w/Lid	250/cs.
75002089	<i>75002089</i>	32 oz., w/Lid	250/cs.



C. GOURMET® FOOD CONTAINERS/LIDS

BRIDGE-GATE ALLIANCE GROUP

Compostable serving ware. Molded fiber pulp product with environmentally advanced technologies, conserving energy and water. Starting with the purest raw materials, the natural byproducts of agricultural waste, Bridge-Gate employs a proprietary, self-contained washing and Biopulping process, minimizing ecological impact from field to factory to foodservice. With Bridge-Gate, you and your customers can be assured of compostable, consistently top-quality products that have been produced with the utmost concern for the environment.

Octagon Containers

B7280029	<i>BGW6OCT</i>	Small, Base	300/cs.
B7280024	<i>BGW8OCT</i>	Medium, Base	200/cs.
B7280023	<i>BGW10OCT</i>	Large, Base	200/cs.

Oval Bowl/Lid

B7280036	<i>BGW24O</i>	24 oz.	500/cs.
B7280047	<i>BGW24OL</i>	Lid Fits 24 oz.	3/100/cs.

Rectangular Containers/Lid

B7280028	<i>BGW8FC</i>	8 oz.	20/25/cs.
B7280027	<i>BGW12FC</i>	12 oz.	20/25/cs.
B7280026	<i>BGW16FC</i>	16 oz.	20/25/cs.
B7280030	<i>BGW32FC</i>	32 oz.	400/cs.
B7280031	<i>BGW3</i>	#3, w/Lid	200/200/cs.
B7280025	<i>BGW816L</i>	Lid Fits 8-16 oz.	20/25/cs.



D. FOOD CONTAINER LID

DOPACO

Fits 32 oz. containers.

66378932	<i>18934</i>	Soup Lid Fits 20636, 26623, 20591	500/cs.
-----------------	--------------	-----------------------------------	---------



Non-Hinged Paper Containers



A. FOOD CONTAINERS/LID

HUHTAMAKI

Paper food containers made with durable, double poly-coated paper. Strong and perfect for hot or cold foods.

Bulk Containers

15301037	71037	8-10 oz., Food Container, White	1000/cs.
15300104	71226	12 oz., Food Container, White	1000/cs.
15301091	71091	16 oz. Squat, Food Container, White	500/cs.
15301840	71840	16 oz. Tall, Food Container, White	1000/cs.

Combo Packs

15301839	71842	8-10 oz., w/Vented Paper Lid, White	250/cs.
15301232	71232	12 oz., w/Plastic Lid, White	250/cs.
15301838	71843	12 oz., w/Vented Paper Lid, White	250/cs.
15301837	71844	16 oz. Tall, w/Vented Paper Lid, White	250/cs.
15301841	71846	32 oz., w/Vented Paper Lid, White	250/cs.

Plastic High Heat Vented Lids - Transparent

High heat vented transparent lid for paper food containers.

15300063	89107	Fits 8/10/12 & 16 (Tall) oz. Cups	1000/cs.
15309112	89112	Fits 16/24/32 oz. Cups	500/cs.



B. STREETSIDE™ FOOD CONTAINERS/LID

HUHTAMAKI

Paper food containers made with durable, double poly-coated paper. Strong and perfect for hot or cold foods.

Bulk Containers

15300278	70310	8-10 oz., Use Lids 89105, 89107, 71872	1000/cs.
15300266	70316	16 oz. Squat, Use Lids 89110, 89112, 71873	500/cs.

Combo Packs

15301842	71849	8-10 oz., w/Black Vented Paper Lid	250/cs.
15301843	71850	12 oz., w/Black Vented Paper Lid	250/cs.
15300281	70416	16 oz. Squat, w/Plastic Lid	250/cs.
15301844	71851	16 oz. Tall, w/Black Vented Paper Lid	250/cs.

Heavyweight Vented Paper Lid

Tight fitting lids for paper food containers.

15301872	71872	Fits 6-8, 8-10, 12, 16 (Tall) oz., Black	1000/cs.
----------	-------	--	----------



C. ECOTAINER® FOOD CONTAINER/LID

INTERNATIONAL PAPER

Made with fully renewable resources; fiber from sustainably managed forests and Ingeo™ a plant-based material (PLA). Meets Sustainable Forestry Initiative® (SFI®) Chain-of-Custody certification standards. Meets ASTM Standards for Compostability. Certified by the Biodegradable Products Institute (BPI). Performance is comparable to standard single-use paper disposables. Made in the USA.

14700332	DFRE8	8 oz.	1000/cs.
14703031	DFRE12COMPASS	12 oz., Compass	1000/cs.
14700124	LFRFH12	Flat/Hot Vented Lid Fits 12 oz.	1000/cs.



D. PRESSWARE® DUAL-OVENABLE TRAYS/LIDS

PACTIV

Dual-ovenable paperboard trays can be used in microwave or conventional ovens at temperatures up to 400°F for up to 60 minutes. For hot and cold food applications. They can be stored in a freezer or refrigerator without cracking or denting, and are ideal for freezer to oven cooking applications. Upscale structural design, along with color and graphics capabilities offer excellent merchandising opportunities for high visual impact. Made from 90% renewable resources. There are two closure options; clear OPS dome lids or peelable film (plastic dome lids are not to be used in microwave or conventional ovens). In the microwave oven, heating is enhanced because Pressware® trays are transparent to microwave energy and cooking hot spot areas are reduced with rounded radius corners and bottoms.

Baker's Assurance®

16200560	PBA7106	23 oz., 7 ¹ / ₄ x 11 ⁵ / ₁₆ x 23/32	500/cs.
----------	---------	---	---------

Blue Country Classic™

16202614	PBC5613R	14 ¹ / ₂ oz., 4 ²⁷ / ₃₂ " x 6 ¹⁷ / ₃₂ " x 1 ³ / ₈ "	1000/cs.
16202615	PBC5615	16 ² / ₃ oz., 4 ²⁹ / ₃₂ " x 6 ³ / ₃₂ " x 1 ¹ / ₁₆ "	500/cs.
16200236	PBC6816	32 oz., 6" x 7 ⁷ / ₈ " x 1 ³ / ₄ "	500/cs.
16200625	PBC7014	45 oz., 7 ¹⁵ / ₃₂ " x 9 ³¹ / ₃₂ " x 1 ¹ / ₂ "	250/cs.



Non-Hinged Paper Containers



CONTAINERS & TRAYS



A. PRESSWARE® DUAL-OVENABLE TRAYS/LIDS (CONT.)

Classic Stoneware™ White/Brown Specks

Item #	Part #	Dimensions	Quantity
16204403	PCS4403	3 1/2 oz., 4 5/16" x 4 5/16" x 3/8", Square	3000/cs.
16201106	PCS4412	5 1/5 oz., 4 3/16" x 4 3/16" x 1 1/4", Square	1500/cs.
16200856	PCS0412	5 7/8 oz., 4 3/16" x 1 1/4", Round	1000/cs.
16202540	PCS0511	7 2/3 oz., 5 1/16" x 1 1/8", Round	1000/cs.
16201053	PCS4413	9 1/2 oz., 4 5/8" x 4 5/8" x 1 3/8", Square	1000/cs.
16202541	PCS4707	9 7/9 oz., 4" x 7 7/16" x 7 7/8", Oblong	1000/cs.
16201054	PCS0713H	12 1/5 oz., 4 7/8" x 7 7/32" x 1 3/8", Oblong	1000/cs.
16200865	PCS4512	13 oz., 4 7/8" x 5 15/16" x 1 1/4", Oblong	1000/cs.
16208501	PCS5611R	13 3/5 oz., 4 29/32" x 6 17/32" x 1 1/8", Oblong	1000/cs.
16208504	PCS5613RR1	14 1/2 oz., 4 27/32" x 6 17/32" x 1 3/8", Oblong	500/cs.
16208503	PCS5613RR1	14 1/2 oz., 4 27/32" x 6 17/32" x 1 3/8", Oblong	1000/cs.
16201119	PCS5613	14 1/2 oz., 4 31/32" x 6 9/16" x 1 3/8", Oblong	1000/cs.
16201123	PCS5710	15 2/5 oz., 5 1/16" x 7 13/16" x 1", Oblong	500/cs.
16208502	PCS5615	16 1/5 oz., 4 29/32" x 6 3/32" x 1 1/16", Oblong	500/cs.
16207342	PCS5811R	20 1/2 oz., 5 29/32" x 8 3/32" x 1 1/8", Oblong	500/cs.
16205714	PCS5713	20 4/5 oz., 5 1/16" x 7 25/32" x 1 3/8", Oblong	250/cs.
16202542	PCS5617	21 oz., 5" x 6 1/2" x 1 7/8", Oblong	500/cs.
16200203	PCS5713R	21 1/3 oz., 5 7/16" x 7 7/16" x 1 3/8", Oblong	500/cs.
16207341	PCS6812R	27 9/10 oz., 6 1/16" x 8 25/32" x 1 1/4", Oblong	500/cs.
16201057	PCS6816	32 oz., 6" x 7 7/8" x 1 3/4", Oblong	500/cs.
16201645	PCS6815	36 7/9 oz., 6 19/32" x 8 3/4" x 1 5/8", Oblong	250/cs.
16204646	PCS7014	45 oz., 7 15/32" x 9 31/32" x 1 1/2", Oblong	250/cs.
16200251	PCS81116	64 1/3 oz., 8 7/16" x 11 31/32" x 1 3/4", Oblong	250/cs.

Ebony Premier®

16200852	PEP4512	13 oz., 4 7/8" x 5 29/32" x 1 1/4"	1000/cs.
16200600	PEP5613R	14 1/2 oz., 4 29/32" x 6 17/32" x 1 3/8"	500/cs.
16201504	PEP5615	16 4/5 oz., 4 15/16" x 6 5/32" x 1 11/16"	500/cs.
16200599	PEP5713R	21 1/3 oz., 5 15/32" x 7 15/32" x 1 3/8"	500/cs.
16201503	PEP6816	32 oz., 6 1/32" x 7 15/16" x 1 3/4"	500/cs.
16209121	PEP7014	45 oz., 7 15/32" x 9 31/32" x 1 1/2"	250/cs.

OPS Dome Lids

16200549	CI80412	Fits PCS0412	1000/cs.
16200646	CI85611R	Fits PCS5611R	1000/cs.
16201118	CI85613	Fits 5613	1000/cs.
16200012	CI85613R	Fits 5613R	1000/cs.
16201125	CI85710	Fits 5710	500/cs.
16200606	CI85615	Fits 5615	1000/cs.
16200848	CI85713	Fits 5713	250/cs.
16205712	CI85713R	Fits 5713R	500/cs.
16208839	CI86816	Fits 6816	500/cs.
16200636	CI8D714	Fits 7014	250/cs.
16200648	CI881116	Fits PCS81116	250/cs.

B. FLEXSTYLE® DOUBLE POLY PAPER

FOOD CONTAINERS/LIDS

SOLO®

You can always count on Solo's very best paper containers. They are designed to meet any service or storage need you may have, including freezing and refrigerating. You can use them with a vented paper lid for soups and other hot foods. Or, for an economical choice, try one of our translucent plastic polypropylene lids.

Containers

18203749	KHB8AJ8000	8 oz., Symphony™	250/cs.
18200984	H40852050	8 oz., White	500/cs.
18704123	H41252050	12 oz., White	500/cs.
18203761	KHB16AJ8000	16 oz., Symphony™	250/cs.
18704265	H41652050	16 oz., White	500/cs.
18700983	H41652050	16 oz., White	500/cs.
18203764	KHB32AJ8000	32 oz., Symphony™	250/cs.
18200771	H43252050	32 oz., White	500/cs.

Spiral Wound Non-Vented Paper Lids

Lid for Flexstyle® hot food containers.

18700713	CH8A4000	Fits H4085, H4125, White	500/cs.
18200831	CH16A4000	Fits H4165, White	500/cs.

Non-Hinged Paper & Hinged Plastic Containers



A. FLEXSTYLE® DOUBLE POLY PAPER FOOD CONTAINERS/LIDS (CONT.)

SOLO®

Combos

18203746	KHB8A2050	8 oz., White	250/cs.
18203753	KHB12A2050	12 oz., White	250/cs.
18203759	KHB16A2050	16 oz., White	250/cs.
18203763	KHB32A2050	32 oz., White	250/cs.
18700932	KH32A2050	32 oz., w/Double Disk Vented Paper Lid, White	250/cs.



B. HOT FOOD CONTAINERS

SOLO®

Heavy-duty paper food containers.

18200303	HD16	16 oz., Designer White	500/cs.
18200290	KH32200	32 oz., Combo, Designer White	250/cs.



C. SINGLE POLY PAPER FOOD CONTAINERS

SOLO®

Try this reliable paper container in an attractive matched service design. It is perfect for just about any occasion and can be used for either hot and cold foods.

18201170	VS508J8000	8 oz., Symphony™	1000/cs.
18705083	VS5082050	8 oz., White	1000/cs.

D. SOLO® DOUBLE SIDED POLY (DSP) PAPER FOOD CONTAINERS

SOLO®

Solo's very best paper containers. They are designed to meet any service or storage need, including freezing and refrigerating. Use them with a vented paper lid for soups and other hot foods. Or, for a more economical choice, top it off with a translucent plastic polypropylene lid.

18201183	H4085J8000	8 oz., Symphony™	500/cs.
18201185	H4125J8000	12 oz., Symphony™	500/cs.
18201186	KH12AJ8000	12 oz. Combo, Symphony™	250/cs.
18201189	H4165J8000	16 oz., Symphony™	500/cs.
18201193	H4325J8000	32 oz., Symphony™	500/cs.



E. SOLO® PAPER LIDS FOR FOOD CONTAINERS

SOLO®

Solo® offers a wide variety of paper food container lids. Made from renewable resources, paper lids deliver excellent performance and value. Solo® containers and lids are engineered to work together, delivering optimal function and performance. Spiral wound non-centered paper.

18708064	CA8A4000	Fits 8 oz. (P4085 & P4125), White	500/cs.
18700714	CA16A4000	Fits 16 oz. (P4165), White	500/cs.



HINGED PLASTIC CONTAINERS

F. CRISP FOOD CONTAINER

ANCHOR PACKAGING

Exclusive, patent-pending, cross-flow® ventilation design to relieve moisture and condensation, while maintaining product temperature. Through-the-closure ventilation, along with raised airflow channels in the base of the container, combined with venting in the anti-fog lid, ensure that fried foods remain crispy. Designed to withstand up to 230°F when placed in warming unit displays and under heat lamps. Holds up to 8 large pieces of chicken, as well as a variety of other fried food items. It is made of polypropylene (#5PP), and is microwave-safe, dishwasher-safe, and consumer reusable and recyclable.

10809101	4669101	74 oz., 9½" x 10½" x 3½", Black	100/cs.
----------	---------	---------------------------------	---------



CONTAINERS & TRAYS



Hinged Plastic Containers

CONTAINERS & TRAYS



A. MICROWAVEABLE CLAMSHELLS ANCHOR PACKAGING

Can withstand temperatures up to 230°F when used under heat lamps, in warming units, and in microwaves. The clear lid is designed with anti-fog technology, and is vented to allow steam to dissipate, keeping fried foods crisp and your product visible to assure order accuracy. Stacking will not block the vents. Secure snap closure ensures freshness, and eliminates spills when transporting. The crack-resistant, cut-resistant polypropylene base allows your customers to eat right out of the container.

Culinary Basics

10809912 4669111 46½ oz., 9½" x 10½" x 2½", 1-Compt. 100/cs.

Culinary Classics®

10806911 4656911 34 oz., 6" x 9" x 3", 1-Compt. 100/cs.

10809111 4659111 39 oz., 9" x 9" x 3⅜", 1-Compt. 100/cs.

10809133 4659033 20/5/5 oz., 9" x 9" x 3⅜", 3-Compt. 100/cs.

10809611 4659611 47½ oz., 9½" x 10½" x 3⅜", 1-Compt. 100/cs.

10809633 4659633 26/7/7 oz., 9½" x 10½" x 3⅜", 3-Compt. 100/cs.



B. DELI VIEW™ SANDWICH WEDGE ANCHOR PACKAGING

Hinged sandwich container with clear base and lid.

10800541 4511019 6⅝" x 3⅜" x 3⅜", Clear/Clear 250/cs.

C. MICROWAVES™ HOT DOG CLAMSHELL ANCHOR PACKAGING

Clear microwavable polypropylene hinged container. For hot, fresh, and chilled foods.

10800349 4489409 7⅝" x 3⅝" x 1½", Clear 250/cs.



D. CLEARSEAL™ CLEAR HINGED LID CONTAINERS DART

Lock in freshness with ClearSeal's exclusive perimeter seal designed to maximize product freshness and reduce leaks. Bar-locks provide a snap-tight secure closure while easily accessible gripper tabs simplify opening. ClearSeal, the clear choice for accentuating the full appeal of your food with confidence.

12500198 C57PST1 6" x 5⅜" x 3", 6" Sandwich 500/cs.

12505735 C90PST1 8¼" x 8¼" x 3", Medium 250/cs.

E. SHOWTIME® CLEAR HINGED CONTAINER DART

Wide side ribbing allows easy viewing from all directions. Corner ribbing provides extra strength, helps avoid crushed containers. Designed to allow stacking of multiple containers. Quick and easy snap-tight locking ensures safe handling.

12505710 C57HT1 6" x 5⅞" x 3¼", Small, Clear 500/cs.



F. STAYLOCK™ HINGED CONTAINER DART

Dual bar-locks with audible snap for secure closure, even after multiple openings. Label window provides ideal placement for labeling or tamper evident seal. Stacking platform provides a positive lock for stable merchandising displays. Chamfered corners increase strength and offer more product visibility. Sidewall ribbing provides maximum strength for durability and crush resistance. Opening tab and dimple allow for easy opening.

12504906 C25UT1 6⅞" x 6½" x 3¼", Clear, 6" Square 500/cs.



G. SANDWICH WEDGE DOUGLAS STEPHEN PLASTICS

Plastic sandwich wedge with hinged lid.

13001140 SW40SB 4¼" x 3" x 6", Large, Clear 250/cs.

H. HARVEST COLLECTION™ HINGED CONTAINERS GENPAK

Compostable dinnerware for foodservice applications. Produced from environmentally friendly, annually renewable resources.

34789246 HCH80 8" x 8" x 2½", Medium, Harvest Tan 200/cs.

34789236 HCH83 8" x 8" x 2½", Medium 3-Compt., Harvest Tan 200/cs.



Hinged Plastic Containers



A. SECURE SEAL® CLEAR HINGED CONTAINERS GENPAK

Made with up to 50% post-consumer recycled content. Patented 360° seal allows for a leak resistant closure. One piece construction. Excellent water-vapor barrier for extended shelf life. Works well with automated filling and sealing lines. Endorsed by the Green Restaurant Association.

34780543	AD04	4 oz., 4 ¹ / ₄ " x 3 ⁵ / ₈ " x 1 ¹ / ₄ "	400/cs.
34780363	AD06	6 oz., 4 ¹ / ₄ " x 3 ⁵ / ₈ " x 1 ⁷ / ₈ "	400/cs.
34780060	AD08	8 oz., 5 ³ / ₈ " x 4 ¹ / ₂ " x 1 ¹ / ₂ "	200/cs.
34780542	AD08F	8 oz., 5 ³ / ₈ " x 4 ¹ / ₂ " x 2", High Dome	200/cs.
34780054	AD12	12 oz., 5 ³ / ₈ " x 4 ¹ / ₂ " x 2 ¹ / ₂ "	200/cs.
34789016	AD16S	16 oz., 7 ¹ / ₄ " x 6 ³ / ₈ " x 1", Shallow	200/cs.
34780055	AD16	16 oz., 5 ³ / ₈ " x 4 ¹ / ₂ " x 2 ⁵ / ₈ "	200/cs.
34785433	AD16F	16 oz., 5 ³ / ₈ " x 4 ¹ / ₂ " x 3", High Dome	200/cs.
34780058	AD24	24 oz., 7 ¹ / ₄ " x 6 ³ / ₈ " x 2 ¹ / ₄ "	200/cs.
34780103	AD24F	24 oz., 7 ¹ / ₄ " x 6 ³ / ₈ " x 2 ⁹ / ₁₆ ", High Dome	200/cs.
34780056	AD32	32 oz., 7 ¹ / ₄ " x 6 ³ / ₈ " x 2 ⁵ / ₈ "	200/cs.
34780114	AD32F	32 oz., 7 ¹ / ₄ " x 6 ³ / ₈ " x 3", High Dome	200/cs.
34780085	AD48	48 oz., 8" x 8 ¹ / ₂ " x 2 ¹ / ₂ "	200/cs.
34780086	AD64	64 oz., 8" x 8 ¹ / ₂ " x 3 ¹ / ₄ "	200/cs.



B. SAFE-T-FRESH® DELI CONTAINERS INLINE PLASTICS

Our unique line of tamper resistant, tamper evident and leak resistant containers. These containers come with the built-in protection afforded by the Safe-T-Gard® Tear Strip Lock. This lock virtually assures that the container you've purchased hasn't been opened since the product was packed. The Safe-T-Gard® Tear Strip Lock is user friendly and, after removing it, the container stays intact and closes easily after you've enjoyed a portion of your favorite goodies. Perfect for fresh cut fruit, deli and bakery packaging.

Round

39351012	TS12R	12 oz., 5 ⁷ / ₈ " x 5 ³ / ₄ " x 2"	240/cs.
39351016	TS16R	16 oz., 5 ⁷ / ₈ " x 5 ³ / ₄ " x 3 ¹ / ₈ "	240/cs.
39350815	TS20	20 oz., 6 ¹ / ₄ " x 4 ¹ / ₁₆ " x 1 ¹ / ₂ "	200/cs.
39350796	TS24RS	24 oz., 7" x 7" x 2 ¹ / ₄ "	150/cs.
39351024	TS24R	24 oz., 7" x 7" x 3 ¹ / ₈ "	150/cs.
39351032	TS32R	32 oz., 7" x 7" x 3 ¹ / ₈ "	150/cs.
39350129	TS52R3	52 oz., 9 ¹ / ₁₆ " x 9 ³ / ₄ " x 3 ³ / ₈ ", 3-Compt.	100/cs.

Rectangular

39351008	TS8	8 oz., 4 ⁷ / ₈ " x 5 ¹ / ₂ " x 1 ³ / ₁₆ "	240/cs.
39350801	TS12	12 oz., 4 ⁷ / ₈ " x 5 ¹ / ₂ " x 2"	240/cs.
39350800	TS16	16 oz., 4 ⁷ / ₈ " x 5 ¹ / ₂ " x 2 ⁵ / ₈ "	240/cs.
39350802	TS24	24 oz., 7 ³ / ₈ " x 5 ³ / ₈ " x 2 ⁵ / ₁₆ "	200/cs.
39350803	TS32	32 oz., 7 ³ / ₈ " x 5 ⁵ / ₈ " x 2 ¹ / ₄ "	200/cs.
39350805	TS48	48 oz., 8 ³ / ₄ " x 7 ⁷ / ₈ " x 2 ³ / ₈ "	150/cs.
39350804	TS64	64 oz., 8 ³ / ₄ " x 7 ⁷ / ₈ " x 2 ³ / ₄ "	150/cs.
39350812	TS64L	64 oz., 8 ³ / ₄ " x 7 ⁷ / ₈ " x 2 ³ / ₄ ", Lighter-Duty for Green Salads	150/cs.



C. SAFE-T-FRESH® HANGABLES® DELI CONTAINERS INLINE PLASTICS

Feature a molded-in hang-tab that pops up out of the Safe-T-Gard® tear strip when the container is closed. Allows the container to hang on a display rack or end-cap throughout the store, or in coolers around the high traffic store perimeter.

39350809	TS8T	8 oz., 4 ⁷ / ₈ " x 5 ¹ / ₂ " x 1 ³ / ₁₆ "	240/cs.
39350816	TS17VT	17 oz., 4 ¹ / ₂ " x 6 ⁵ / ₈ " x 2"	320/cs.

D. SAFE-T-FRESH® SANDWICH WEDGE INLINE PLASTICS

Tamper resistant seal locks in freshness and eliminates the need for shrink bands and labels to prevent product tampering. Crystal clear PET packaging.

39350146	TS1SW	7 ⁵ / ₁₆ " x 4 ¹ / ₈ " x 3 ⁵ / ₈ "	288/cs.
----------	-------	--	---------





Hinged Plastic Containers

CONTAINERS & TRAYS

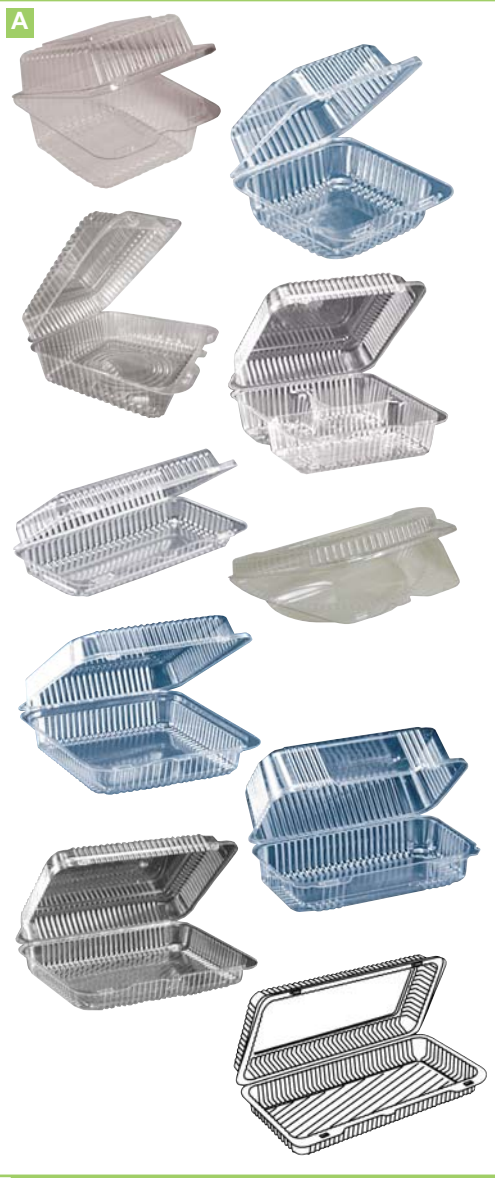

A. SURE LOCK® HINGED CONTAINERS INLINE PLASTICS

Sure Lock® keeps container closed until customer opens it. Lid will not open unexpectedly for maximum closure security during transit or while handling. Crystal clear material.

Relaxed hinge design.

39350947	SLP19	3 ¹ / ₂ " x 7 ⁷ / ₈ " x 3 ³ / ₈ "	300/cs.
39352309	SLP10	5 ¹ / ₈ " x 5 ¹ / ₈ " x 2 ¹ / ₈ "	500/cs.
39350926	SL20	5 ¹ / ₈ " x 5 ¹ / ₈ " x 2 ⁵ / ₈ "	500/cs.
39350940	SLP20D	5 ¹ / ₈ " x 5 ¹ / ₈ " x 3 ¹ / ₈ "	500/cs.
39350930	SLP25	6 ¹ / ₁₆ " x 6 ¹ / ₁₆ " x 3 ⁵ / ₁₆ "	500/cs.
39350902	SLP26	6 ¹⁵ / ₁₆ " x 5 ⁷ / ₈ " x 2 ¹ / ₁₆ "	300/cs.
39350944	SLP17XD	7 ¹ / ₄ " x 4 ⁷ / ₁₆ " x 2 ⁹ / ₁₆ "	400/cs.
39350912	SLP17A	7 ¹ / ₄ " x 4 ⁷ / ₁₆ " x 3 ¹ / ₈ "	300/cs.
39350960	SLP15B	8" x 4 ¹³ / ₁₆ " x 3 ⁵ / ₈ "	500/cs.
39350097	SLP70	8 ¹ / ₄ " x 8 ³ / ₄ " x 3 ¹ / ₂ "	200/cs.
39350984	SLP73	8 ¹ / ₄ " x 8 ³ / ₄ " x 3 ¹ / ₂ ", 3-Compt.	200/cs.
39350990	SLP18	8 ¹ / ₂ " x 4 ⁷ / ₁₆ " x 1 ⁷ / ₈ "	300/cs.
39350934	SLP18D	8 ¹ / ₂ " x 4 ⁷ / ₁₆ " x 2 ¹¹ / ₁₆ ", Deep Base	300/cs.
39350900	SLP55	8 ⁹ / ₁₆ " x 9" x 2 ¹⁵ / ₁₆ "	300/cs.
39350927	SLP208	8 ¹³ / ₁₆ " x 5 ⁵ / ₁₆ " x 1 ⁷ / ₈ ", Half 8" Pie, Calzone	250/cs.
39350945	SLP35	8 ⁷ / ₈ " x 5 ¹ / ₈ " x 3 ³ / ₈ "	500/cs.
39350968	SLP30	9 ³ / ₈ " x 6 ³ / ₄ " x 2 ³ / ₁₆ "	300/cs.
39350920	SLP32	9 ³ / ₈ " x 6 ³ / ₄ " x 2 ⁵ / ₈ "	300/cs.
39350948	SLP40S	9 ³ / ₈ " x 6 ³ / ₄ " x 2 ¹¹ / ₁₆ "	300/cs.
39350057	SLP40	9 ³ / ₈ " x 6 ³ / ₄ " x 3 ¹ / ₁₆ "	276/cs.
39350914	SLP38D	9 ¹ / ₂ " x 5 ¹ / ₂ " x 4 ¹ / ₈ "	200/cs.
39350928	SLP209	10" x 6 ¹ / ₁₆ " x 2 ⁵ / ₁₆ ", Half 9" Pie, Calzone	250/cs.
39350915	SLP57	10 ¹ / ₂ " x 8 ⁵ / ₁₆ " x 2 ⁵ / ₈ "	300/cs.
39350901	SLP80	10 ¹ / ₂ " x 8 ⁹ / ₁₆ " x 3 ⁵ / ₈ "	300/cs.
39350931	SLP75	12 ³ / ₈ " x 6 ¹ / ₄ " x 2 ¹ / ₈ "	300/cs.
39350909	SLP90	13 ⁵ / ₁₆ " x 6 ¹¹ / ₁₆ " x 2 ¹ / ₂ "	200/cs.

B. VALU PACK® HINGED CONTAINERS INLINE PLASTICS

Crystal clear 100% recyclable PET. Ideal to promote commitment to environmentally responsible packaging. Automation friendly design. Easy-to-open; container and its contents will not be damaged while opening. Sure Lock® double line locks provide maximum security. Stackable. Sanitary over lid design.

39350060	VPP756	33 ¹ / ₂ oz., 5 ¹⁵ / ₁₆ " x 5 ¹⁵ / ₁₆ " x 3 ¹ / ₆ "	500/cs.
39350875	VPP781	44 ⁹ / ₁₀ oz., 8 ¹³ / ₁₆ " x 4 ⁷ / ₈ " x 3 ³ / ₁₆ "	300/cs.
39350071	VPP747	72 ¹ / ₅ oz., 8 ⁹ / ₁₆ " x 7 ¹⁵ / ₁₆ " x 2 ⁷ / ₈ "	250/cs.
39350119	VPP757	82 ⁴ / ₅ oz., 8 ⁹ / ₁₆ " x 7 ¹⁵ / ₁₆ " x 3 ⁵ / ₁₆ "	250/cs.
39350076	VPP730	97 ¹ / ₃ oz., 9" x 9 ⁷ / ₁₆ " x 3"	200/cs.
39350086	VPP731	9" x 9 ⁷ / ₁₆ " x 3", 3-Compt., Lunch box	200/cs.

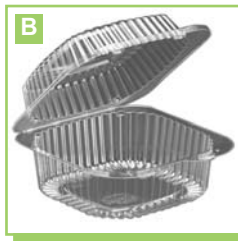

C. CLEARVIEW™ DELI CONTAINERS PACTIV

Hinged lid deli containers.

16201013	CA91008	8 oz., Clear, Plastic	200/cs.
16201012	CA91012	12 oz., Clear, Plastic	200/cs.
16201016	CA91016	16 oz., Clear, Plastic	200/cs.
16201024	CA91024	24 oz., Clear, Plastic	200/cs.
16201032	CA91032	32 oz., Clear, Plastic	200/cs.
16202171	CA91048	48 oz., Clear, Plastic	190/cs.



Hinged Plastic Containers



A. CLEARVIEW™ SMARTLOCK® CONTAINERS PACTIV

Smartlock® closure system is easy to understand. Secure seal helps resist leaks. Durable hinge resists breaking. Stack stabilizers add strength for more secure stacking. Smooth panels allow for easy labeling. Drainage grid helps keep items out of accumulated moisture.

Hexware™

16201707	EH89160	6" x 3", Black/Clear	120/cs.
16201708	EH89170	7 1/2" x 3", Black/Clear	120/cs.
16201711	EH89190	9" x 3", Black/Clear	110/cs.
16201712	EH89193	9" x 3", 3-Compt., Black/Clear	110/cs.

Rectangular

16201426	CI81050	5 1/4" x 5 1/4" x 2 1/2", 5" 1-Compt., Black/Clear	375/cs.
16201818	CI83011	5 1/2" x 9 1/8" x 3 3/8", Clear	290/cs.
16201379	CI81160	5 3/4" x 6" x 3", 6" 1-Compt., Black/Clear	500/cs.
16201713	EH89612	5 3/4" x 7 7/8" x 2 1/4", Black/Clear	200/cs.
16202416	CAH3025	6 5/8" x 13 2/34" x 2 1/4", Clear	100/cs.
16201819	CI83025	7" x 13 1/2" x 2 1/4", Clear	105/cs.
16201584	CI81120	8 13/64" x 8 11/32" x 2 29/32", Black/Clear	200/cs.
16201586	CI81123	8 13/64" x 8 11/32" x 2 29/32", 3-Compt., Black/Clear	200/cs.
16201424	CI81048	8 1/2" x 4" x 2 1/2", Clear	250/cs.
16201732	EH89148	8 1/2" x 4 1/2" x 3 1/4", Hoagie, Black/Clear	240/cs.
16209430	CI81030	8 5/8" x 7 1/8" x 3", Black/Clear	250/cs.
16201375	CI81110	9 7/32" x 8 7/8" x 2 29/32", Black/Clear	200/cs.
16201376	CI81113	9 7/32" x 8 7/8" x 2 29/32", 3-Compt., Black/Clear	200/cs.
16201425	CI81049	9 1/4" x 4 1/2" x 3", Clear	250/cs.
16201815	CI82030	9 1/4" x 6 1/4" x 2", 1-Compt., Black/Clear	200/cs.
16201816	CI82035	9 1/4" x 6 1/4" x 2 5/8", 1-Compt., Black/Clear	200/cs.
16201817	CI82040	9 1/4" x 6 1/4" x 3 1/4", 1-Compt., Black/Clear	200/cs.
16201704	EH89111	10 3/4" x 8" x 3 1/4", Black/Clear, 1-Compt.	125/cs.
16201705	EH89112	10 3/4" x 8" x 3 1/4", Black/Clear, 2-Compt.	125/cs.
16201731	CI83035	10 3/4" x 9 1/4" x 3 1/2", Black/Clear	150/cs.



B. EARTHCHOICE® CLEAR HINGED LID CONTAINER PACTIV

Made with Ingeo™. 100% annually renewable material made from plants. Exceptional clarity. Stackable. Label panels. Leak resistant deli lid closure. ASTM D 6400 certified and compostable.

16202773	YLI811200000	49 oz., 8 13/64" x 8 11/32" x 2 29/32"	200/cs.
----------	--------------	--	---------

C. EARTHCHOICE® SMARTLOCK® HINGED LID CONTAINERS PACTIV

Social responsibility, respect and care for the environment require action today while keeping an eye on the future. Pactiv has developed a new line of "to-go" hinged lid containers that captures the latest innovations in hybrid materials. EarthChoice® SmartLock® hinged lid containers are made from talc-filled polypropylene which contains on average 40% less plastic polymers than standard polypropylene containers. This hybrid material is microwaveable up to 250°F and is ideal for your hot food take-out menu items. SmartLock® Closure System provides an audible "click" indicating a secure closure. Textured sidewalls provide more secure handling. Stackable.

16203095	CN80600	16 oz., 5 15/16" x 5 3/4" x 3 1/4", Sandwich 1-Compt.	400/cs.
16202936	CN80801	32 oz., 8 1/3" x 8 1/3" x 3 2/5", Medium 1-Compt.	200/cs.
16202938	CN80803	4/4/14 oz., 8 1/3" x 8 1/3" x 3 2/5", Medium 3-Compt.	200/cs.
16201405	CN80901	42 oz., 8 7/8" x 9 1/3" x 3 1/3", Large 1-Compt.	100/cs.
16202937	CN80901	42 oz., 8 7/8" x 9 1/3" x 3 1/3", Large 1-Compt.	120/cs.
16201404	CN80903	6/6/18 oz., 8 7/8" x 9 1/3" x 3 1/3", Large 3-Compt.	100/cs.
16202941	CN80903	6/6/18 oz., 8 7/8" x 9 1/3" x 3 1/3", Large 3-Compt.	120/cs.
16203105	CN80961	24 oz., 9" x 6" x 3", 1-Compt.	270/cs.



D. OCTAGON CLAMSHELL PACTIV

Hinged black base/clear lid PET octagon container. This clear hinged container is great for displaying salads or any products in a cold display. Show your appetizing meal solutions in this container with a secure closure!

16203244	12092	33 oz., 9 1/8" x 2 1/2", Black/Clear	150/cs.
----------	-------	--------------------------------------	---------



Hinged Plastic Containers

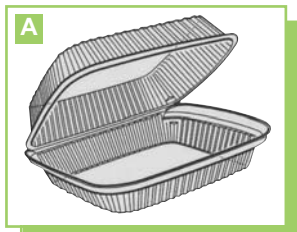

A. THE SELL OUT® HINGEWARE CONTAINERS PACTIV

Conventional hinged lid containers have excellent clarity and are made of durable OPS material. For warm and cold applications.

16201762	94130	9" x 8" x 1 1/5", Medium Low, Clear	180/cs.
16201766	94111	9 1/2" x 9 1/2" x 3 3/8", Large Deep, Clear	160/cs.



B. HINGED CONTAINER PACTIV-PWP

PWP's hinged containers provide customers with the convenience of an always-attached cover, allowing for easy access to the contents. With label panel.

64933751	08SH30SLP	8 2/3" x 8 2/3" x 3", Clear, 8" Square Swirl	200/cs.
-----------------	-----------	--	---------



C. SHO-BOWL® CONTAINERS PACTIV REYNOLDS

Clear PETE plastic hinged lid containers.

18900841	10841	8 oz., Dome Lid	250/cs.
17300034	10845	12 oz., Dome Lid	250/cs.
18904017	10847	16 oz., Flat Lid	250/cs.
17300642	10849	16 oz., Dome Lid	250/cs.
17300857	10857	20 oz., Dome Lid	150/cs.
17300029	10861	24 oz., Dome Lid	150/cs.
17300641	10865	32 oz., Dome Lid	150/cs.



D. SNACK CLAM/PACK PACTIV REYNOLDS

Two compartment, hinged.

17300059	11248	8" x 6 1/4" x 2 1/4", 2-Compt., Clear	150/cs.
-----------------	-------	---------------------------------------	---------



E. ULTRA FRESH™ SANDWICH WEDGE W/HINGED LID PACTIV REYNOLDS

Sandwich wedge with hinged lid.

17301133	11334	6 1/2" x 3" x 3 1/4", Clear base with clear lid.	250/cs.
-----------------	-------	--	---------

F. ULTRA PAC® OCTAGON CLAMSHELLS PACTIV REYNOLDS

Clear clamshells with black base. PETE plastic.

18908650	12094	22 oz., 6 1/2" x 2 1/2"	150/cs.
18905325	12091	44 oz., 9" x 1 1/8"	150/cs.



G. UTILITY CONTAINER PAR-PAK

Hinged, single cavity utility container for bakery, deli, and foodservice items. Smooth wall lid.

16502253	02253	5 3/8" x 5 5/16" x 2 5/16", Clear	500/cs.
-----------------	-------	-----------------------------------	---------



H. EXPRESSIONS® ECO™ HINGED CONTAINER SOLO®

Made with environmentally friendly Ingeo™ plastic. Created from plants, not petroleum.

ECO™ containers meet the ASTM Standards for Compostability as certified by the Biodegradable Products Institute. They biodegrade in a commercial compost facility within 60-180 days without releasing any toxic residues. Approved by Cedar Grove Composting, Inc., this innovative line of packaging is disposable with food waste, no separation is required!

12604050	0854011	9" x 3", Tan	200/cs.
-----------------	---------	--------------	---------



I. HINGED CONTAINER SOLO®

Attractive black base with smooth clear lid enhances food presentation and creates an elegant impression that drives sales. One-piece package with easy-to-close lids adds speed and ease of use to the operation. Variety of space efficient, stackable shapes and sizes make distinctive displays that stand out from the competition. Cold applications.

18203429	851611PS94	6 1/5" x 5 7/16" x 2 1/8", Small, Black/Clear, 1-Compt.	200/cs.
-----------------	------------	---	---------

Hinged Plastic Containers/Plastic Bowls/Lids



A. OCTAVIEW® HINGED CONTAINERS

SOLO®

Convenient one-piece design. Elegant, black base. Crystal clear anti-fog lid. Stackable design. Leak Guard air-tight seal.

12608626	0862611	6" Deep	200/cs.
18203467	865612PS94	7" Deep	100/cs.
12600864	0865611	7½" Medium, 1-Compt.	100/cs.
12605612	0865612	7½" Deep, 1-Compt.	100/cs.
18203458	864611PS94	9" Shallow	100/cs.
12600002	0864611	9" Shallow, 9 ⁵ / ₇ " x 9 ² / ₁₁ " x 1 ¹⁵ / ₁₆ "	100/cs.
12600863	0864612	9" Deep, 1-Compt.	100/cs.
12600016	0864628	9" Medium, 3-Compt.	100/cs.

LeakGuard. Recyclable (#1). Safe to 150°F. Crystal clear lid. Secure stackability. Designed for portion control.

12605044	865044AP94	7½" Deep	100/cs.
----------	------------	----------	---------



B. CLAMSHELL TAKEOUT BOXES

TRELLIS EARTH®

Trellis Earth® bioplastic takeout boxes provide a viable, non-toxic, disposable alternative. A unique blend of corn polymers, starches and complimentary ingredients are 100% biodegradable and can be taken straight from the fridge to the microwave for easy and efficient reheating.

C4780031	WFH12	4" x 8" x 3", Medium	400/cs.
C4780026	WFH01	7" x 4½" x 2½", Small	500/cs.
C4780061	WFH22	8" x 8", 1-Section	150/cs.
C4780062	WFH21	8" x 8", 3-Section	150/cs.
C4780025	WFH10	8" x 8" x 3", Large	300/cs.
C4780089	WFH14	9" x 9" x 3", X-Large	200/cs.



C. SEESHELL® HINGED CONTAINERS

WILKINSON INDUSTRIES

Nothing seals like a SeeShell®. The industry's most versatile clamshell packaging keeps perishables fresher, longer. Unique continuous seal eliminates gaps and prevents leaks typical of corner-lock clamshell packaging. Two contact points. Crystal clear OPS construction.

19204622	N20	6 ⁵ / ₃₂ " x 6 ⁵ / ₃₂ " x 3 ⁵ / ₃₂ ", Clear	250/cs.
19204633	N32	7 ³ / ₁₆ " x 7 ¹¹ / ₁₆ " x 2 ²⁷ / ₃₂ ", Medium, Deep, Clear	160/cs.
19204648	N48	9" x 5" x 3 ³ / ₈ ", Clear	250/cs.



PLASTIC BOWLS/LIDS

D. INCREDI-BOWL MICROWAVEABLE LID

ANCHOR PACKAGING

Clear polypropylene, anti-fogging vented lid designed to fit Incredi-Bowls. Suitable for heat lamp, heating unit, and microwave use, and will stand up to 230°F.

10805800	4335802	Fits 12 & 16 oz.	250/cs.
----------	---------	------------------	---------



E. SQUARE BOWL LID

CLEAR LAM PACKAGING

PLA. Fits SQ9BDFCR.

13220788	SQ9LCPLA	9", Clear	300/cs.
----------	----------	-----------	---------

F. CRYSTALLINE SALAD BOWL/LID

GENPAK

Manufactured from premium grade APET material, these bowls will resist breakdown from oil and juices from even the most acidic fruits.

34781117	CW032	32 oz., Clear	200/cs.
34785608	BWS932	Lid Fits 24 & 32 oz.	200/cs.

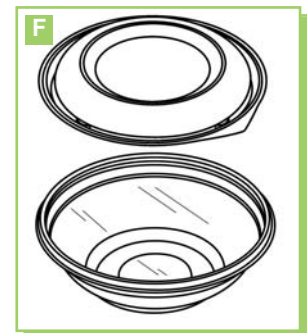



Plastic Bowls/Lids

CONTAINERS & TRAYS

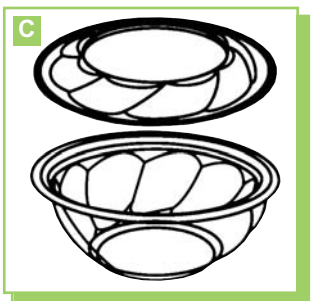

A. SHOWCASE DESIGNER® BOWLS/LIDS PACTIV

Paneled round shape makes food displays more creative and attractive. Tight-fitting lids help food stay fresher longer with fewer spills. Stable stacking lid recesses ensure stack security for better displays and easier handling. Easy-open tab.

16201991	92008	8 oz., 5 1/2" x 1 7/8", Clear	300/cs.
16201977	92012	12 oz., 5 1/2" x 1 7/8", Clear	300/cs.
16201992	92016	16 oz., 5 1/2" x 2 3/5", Black	300/cs.
16201994	92025	24 oz. Shallow, 7 1/2" x 1 4/5", Clear	300/cs.
16201997	92032	32 oz., 7 1/2" x 2 1/3", Clear	300/cs.
16202008	P92008H	Dome Lid, 5 1/2" x 15/16"	300/cs.
16202012	P92025H	Dome Lid, 7 1/2" x 31/64"	300/cs.

B. SWIRL BOWL COMBOS PACTIV-PWP

Our crack-resistant, stackable containers are made exclusively with the highest quality PETE, ensuring durable designs, reduced spoilage, and protection from damaging odors and freezer burn. Swirl leak resistant lid.

64930366	Y516PSSL	16 oz., Clear, 5" Round Swirl	280/cs.
64931045	1040P3CCSL	40 oz., 10", 3-Compt.	100/cs.

C. SWIRL PRODUCE BOWLS PACTIV-PWP

Leak resistant swirl bowl with swirl lid. PWP's leak-resistant bowls ensure your products stay fresher longer. Leak-resistant packages are also available with juice traps. Your products will look as fresh as the day they were born (or picked, peeled, or baked).

64930723	0718PSSL	18 oz., 6 7/8" x 2", Combo, Clear	300/cs.
64930736	0732PSSL	32 oz., 6 7/8" x 2 7/8", Combo, Clear	300/cs.
64930777	0747PSSL	48 oz., 6 7/8" x 3 1/8", Combo, Clear	150/cs.
64930327	1064SJ200	64 oz., 9 3/4" x 2 3/4", Bowl, Clear	200/cs.
64931056	1064PSSL	64 oz., 9 3/4" x 2 3/4", Combo, Clear	100/cs.

D. BOWL 2™ SQUARE BOWLS/LIDS SABERT

Combines the merchandising appeal of upscale round bowls with the space-saving efficiencies of a square design. Crack and crush resistant design provides added security for transportation. Pop-tight lids deliver the ultimate in leak resistance for secure handling.

62208024	18024B300	24 oz., 7 1/2" x 7 1/2", Clear	300/cs.
62208032	18032B300	32 oz., 7 1/2" x 7 1/2", Clear	300/cs.
62209950	99032B150	32 oz., 9" x 9", Black	150/cs.
62204148	19032B150	32 oz., 9" x 9", Clear	150/cs.
62202086	52800B300	Lid Fits 7 1/2" x 7 1/2", Clear	300/cs.
62203150	52900B150	Lid Fits 9" x 9", Clear	150/cs.

E. HIGHLIGHTS® SALAD BOWLS/LIDS SOLO®

Merchandise salads, side dishes and cold entrees with our Highlights® line. These clear containers are simply ideal for pre-pack, self-serve and takeout applications and give their contents an enticing, fresh look. You can also try them in black for an upscale appearance.

18700775	CRS8X0090	8 oz., Clear, PET	500/cs.
18700780	CRS12X0090	12 oz., Clear, PET	500/cs.
18700056	BRS16X0004	16 oz., Black, PET	500/cs.
18700785	CRS16X0090	16 oz., Clear, PET	500/cs.
18700790	CRS24X0090	24 oz., Clear, PET	500/cs.
18700320	BRS32X0004	32 oz., Black, PET	300/cs.
18205408	CRS32X0090	32 oz., Clear, PET	300/cs.
18700645	CRS48X0090	48 oz., Clear, PET	300/cs.
18700650	CRS64X0090	64 oz., Clear, PET	300/cs.
18205426	LCR16D0090	Dome Flat Top Lid Fits 16/24 oz., Clear	10/100/cs.
18205415	LCR64D0090	Dome Flat Top Lid, Fits 32, 48 & 64 oz., Clear	600/cs.

Non-Hinged Plastic Containers



NON-HINGED PLASTIC CONTAINERS

A. PRIME SOURCE® DELI CONTAINERS/LIDS PRIME SOURCE®

Containers and lids made from polypropylene. Resistant to fats and oils. Microwaveable and dishwasher safe.

Containers Only

75002440	75002440	8 oz., Clear	500/cs.
75002450	75002450	8 oz., White	500/cs.
75002441	75002441	12 oz., Clear	500/cs.
75002451	75002451	12 oz., White	500/cs.
75002442	75002442	16 oz., Clear	500/cs.
75002452	75002452	16 oz., White	500/cs.
75002447	75002447	16 oz. XL, Clear	500/cs.
75002443	75002443	24 oz., Clear	500/cs.
75002453	75002453	24 oz., White	500/cs.
75002444	75002444	32 oz., Clear	500/cs.
75002454	75002454	32 oz., White	500/cs.
75002449	75002449	32 oz. XL, Clear	500/cs.

Lids

75002458	75002458	Fits All, Black	500/cs.
75002446	75002446	Fits All, Clear, Injection Molded	500/cs.
75002445	75002445	Fits All, Clear, Thermoformed	500/cs.

Combo Packs

75002460	75002460	8 oz., Clear	250/cs.
75002470	75002470	8 oz., White	250/cs.
75002461	75002461	12 oz., Clear	250/cs.
75002471	75002471	12 oz., White	250/cs.
75002462	75002462	16 oz., Clear	250/cs.
75002472	75002472	16 oz., White	250/cs.
75002456	75002456	16 oz. XL, Clear	250/cs.
75002463	75002463	24 oz., Clear	250/cs.
75002473	75002473	24 oz., White	250/cs.
75002464	75002464	32 oz., Clear	250/cs.
75002474	75002474	32 oz., White	250/cs.



B. PRIME SOURCE® OVERCAP PRIME SOURCE®

Polypropylene overcap.

75002465	75002465	Clear, Fits Food & Deli Containers	500/cs.
----------	----------	------------------------------------	---------

C. PRIME SOURCE® ROASTER PRIME SOURCE®

Chicken roaster combo. Black base with clear dome cover.

75002591	75002591	Medium, Black/Clear	100/cs.
----------	----------	---------------------	---------



D. MICRORAVES™ 400 MICROWAVEABLE RECTANGULAR TRAYS/LIDS ANCHOR PACKAGING

Microwaveable packaging with heat tolerance up to 230°F in the microwave or display case. This product is one of the toughest and lightest plastics. Unique design promotes structural integrity. Uses #4304000 or 4334000 lids.

10800414	4540416	16 oz., 8 ⁵ / ₁₂ " x 6 ⁵ / ₁₂ " x 1 ² / ₁₁ ", Black	250/cs.
10800424	4540424	24 oz., 8 ⁵ / ₁₂ " x 6 ⁵ / ₁₂ " x 1 ¹ / ₂ ", Black	250/cs.
10800431	4540433	32 oz., 8 ⁵ / ₁₂ " x 6 ⁵ / ₁₂ " x 1 ¹⁵ / ₁₆ ", Black	250/cs.
10806002	4304000	Dome Lid Fits 4540416, 4540424, 4540433, 8 ⁵ / ₁₂ " x 6 ⁵ / ₁₂ " x 1", Clear	250/cs.
10802210	4334000	Vented Dome Lid Fits 4540416, 4540424, 4540433, 8 ⁵ / ₁₂ " x 6 ⁵ / ₁₂ " x 1", Clear	250/cs.



Non-Hinged Plastic Containers



A. MICRORAVES™ 800 FLAT LID ANCHOR PACKAGING

All 800 series feature common lid fits with double snap closures to reduce leaks and offer air tight protection. Fits #4608101, 4608121, 4608131 platters.

10808001 4380000 5⁷/₈" x 9¹/₂" x 1¹/₄", Clear 250/cs.



B. MICRORAVES™ 900 MICROWAVE CONTAINERS/LID ANCHOR PACKAGING

Microwaveable packaging with heat tolerance up to 230°F in the microwave or display case. This product is one of the toughest and lightest plastics. Unique design promotes structural integrity. Uses #4409000 lid.

10800920 4590912 12 oz., 8" x 5³/₄" x 1¹/₁₆", Black 250/cs.
10800096 4119120 12 oz., 8" x 5³/₄" x 1¹/₁₆", Combo, Black/Clear 125/cs.
110800921 4590916 16 oz., 8" x 5³/₄" x 1¹/₂", Black 250/cs.
10809005 4409000 Dome Lid Fits 4590912 & 4590916, Clear 250/cs.



C. MICRORAVES™ M700 LID ANCHOR PACKAGING

Microwavable polypropylene large platters and lids are available in single and multi-compartment for entrees, sides, or meals. Polypropylene bases and lids are microwavable to 230°F. (PETE lids are not microwavable or heat resistant.)

10800110 4300710 Dome Lid, 10¹/₄" x 7¹/₄" x 15¹/₁₆", 1-Compt. 250/cs.



D. MICRORAVES™ RIB CONTAINERS ANCHOR PACKAGING

Rib containers with black polypropylene bases and clear OPS lids provide excellent visibility for merchandising. Polypropylene bases are microwavable to 230°F. OPS lid may be used in microwave one time. Combo packed for convenience.

10801900 4401900 10⁷/₈" x 7" x 2⁵/₁₆", Half Slab 100/cs.
10802000 4402000 16⁵/₈" x 7" x 1⁵/₈", Full Slab 100/cs.

E. THE ROASTER™ CHICKEN ROASTER COMBOS ANCHOR PACKAGING

Both dome lid and base are made of microwavable polypropylene and will not crack like polystyrene. Double vents allow steam to escape more freely to reduce condensation build-up. Clearguard® internal anti-fog is co-extruded into the lid material which eliminates the greasy feel found in other lids. Unique stacking feature keeps container secure without blocking the vents in the lid. Revolutionary V-lock™ system prevents moisture from collecting around the flange to eliminate leakage and improve lid fit.

10809001 4110001 9¹⁵/₁₆" x 7⁹/₁₆" x 4¹¹/₁₆", Large 100/cs.
10801185 4111185 10⁷/₈" x 7⁹/₁₆" x 3³/₁₆", Low Dome, Black/Clear 100/cs.
10800300 4110300 10¹/₃" x 8¹⁵/₁₆" x 4³/₄", X-Large 100/cs.



F. SMART-SET® PRO MICROWAVE SAFE CONTAINERS/LIDS GENPAK

Produced with revolutionary textured microwave safe material. This texture finish feels cooler to the touch when compared to traditional microwave safe containers. Provides a more secure, less slippery finish. Part of a continuing source reduction program. These microwave containers will perform as well as, or in many cases, better than the other microwave safe containers out there, while using up to 20% less material in the manufacturing process.

Rectangular

34782444 FPR012 12 oz., Black 300/cs.
34782440 FPR024 24 oz., Black 300/cs.
34780196 FPR032 32 oz., Black 300/cs.

Rectangular Lids

34782443 FPR916 Fits FPR012, FPR016, Clear 300/cs.
34782441 FPR932 Fits FPR024, FPR032, Clear 300/cs.

Round

34780069 FP016 16 oz., Black 300/cs.
34782413 FP032 32 oz., Black 300/cs.

Round Lids

34780070 FP916 Fits FP016, Clear 300/cs.
34780932 FP932 Fits FP024, FP032, Clear 300/cs.



Non-Hinged Plastic Containers



A. NATURE FRIENDLY® PLA ROUND CONTAINERS/LIDS

NATURE FRIENDLY PRODUCTS

Nature Friendly Products' 100% biodegradable and compostable PLA containers and trays provide consumers with an eco-friendly alternative to traditional disposables. Made from corn-based PLA renewable resources, they are completely compostable within 50-100 days in commercial composting facilities. These products are superior in strength and performance, non-toxic, and clear in color.

C6938030	<i>RC95250</i>	8 oz., Container	2000/cs.
C6938031	<i>U120500</i>	16 oz., Container	1000/cs.
C6938032	<i>U1411000</i>	32 oz., Container	600/cs.
C6938035	<i>L959</i>	Lid Fits 8 oz.	2000/cs.
C6938036	<i>L12016</i>	Lid Fits 16 oz.	1000/cs.
C6938037	<i>L14116</i>	Lid Fits 32 oz.	600/cs.



B. CLEARVIEW™ MEALMASTER® CHICKEN BARN™ CONTAINERS

PACTIV

Chicken Barn™ container with SmartTote™ handle. Dimples/ribs in base help trap grease away from food. SmartVent™ system allows steam to vent, keeping fried foods crisp.

Exceptional temperature endurance maintains product integrity for up to four hours in a hot case. Microwaveable base provides one-time microwave reheating.

16203002	<i>CNC3002</i>	2 pc., 7 ² / ₃ " x 6 ² / ₃ " x 3 ¹ / ₃ ", Small	200/cs.
16201557	<i>CNC3004</i>	4 pc., 9 ¹ / ₂ " x 8" x 3", Small	100/cs.
16202545	<i>CNC3008</i>	8 pc., 13 ³ / ₁₀ " x 8 ² / ₅ " x 4", Medium	105/cs.
16201598	<i>CNC3016</i>	16 pc., 14" x 10 ¹ / ₂ " x 4", Large	50/cs.



C. CLEARVIEW™ MEALMASTER® HMR CONTAINERS/LIDS

PACTIV

Rigid bases withstand microwave temperatures up to 220°F without burn through, warping or excessive softening. Lids feature Fog Gard™ coating.

Trays

16203054	<i>CN84612</i>	12 oz., 6 ¹ / ₈ " x 4 ⁷ / ₈ " x 1 ⁵ / ₈ ", Black	232/cs.
16200290	<i>CN84616</i>	16 oz., 8 ¹ / ₈ " x 6 ¹ / ₂ " x 1", Black	250/cs.
16202897	<i>CN84624</i>	24 oz., 8 ¹ / ₈ " x 6 ¹ / ₂ " x 1 ¹ / ₂ ", Black	252/cs.
16202898	<i>CN84632</i>	32 oz., 8 ¹ / ₈ " x 6 ¹ / ₂ " x 2", Black	252/cs.
16201322	<i>CN84636</i>	36 oz., 9 ³ / ₈ " x 8" x 1 ¹ / ₂ ", Black	250/cs.
16200292	<i>CN84637</i>	10 oz./21 oz., 9 ³ / ₈ " x 8" x 1 ¹ / ₂ ", 2-Compt., Black	250/cs.
16204638	<i>CN84638</i>	(2) 4 ¹ / ₂ oz./21 oz., 9 ³ / ₈ " x 8" x 1 ¹ / ₂ ", 3-Compt., Black	250/cs.

Dome Lids

16202761	<i>CN8460H</i>	Fits 6 ¹ / ₈ " x 4 ⁷ / ₈ ", Clear	232/cs.
16200468	<i>CN8460H</i>	Fits 6 ¹ / ₈ " x 4 ⁷ / ₈ ", Clear	250/cs.
16202755	<i>CN8462H</i>	Fits 8 ¹ / ₈ " x 6 ¹ / ₂ ", Clear	252/cs.
16202789	<i>CN8467H</i>	Fits 9 ³ / ₈ " x 8", 2-Compt., Clear	252/cs.
16202828	<i>CN8468H</i>	Fits 9 ³ / ₈ " x 8", 3-Compt., Clear	252/cs.



D. CLEARVIEW™ MEALMASTER® RIB CONTAINERS W/DOME LID

PACTIV

Ideal for ribs which will be sold hot or cold and re-heated by the customer. These containers also are excellent for ribs merchandised in a hot case. Combo pack with base and dome lid with Fog Gard™ coating.

16202687	<i>CNC6509</i>	10 ¹³ / ₁₆ " x 7 ¹ / ₈ " x 2 ⁵ / ₁₆ ", Half Slab	80/cs.
16202762	<i>CNC6514</i>	16 ⁵ / ₈ " x 7 ¹ / ₈ " x 2 ⁵ / ₁₆ ", Full Slab	80/cs.



E. CLEARVIEW™ MEALMASTER® ROASTER COMBOS

PACTIV

Black heat-resistant base and clear polystyrene dome lid. Anti-fog coating that improves merchandising and can withstand temperatures of approximately 170°F. Exclusive snap-in deli seal provides leak-resistance and helps maintain product freshness. Microwaveable base enables customers to reheat in a microwave oven. Base withstands temperatures up to 200°F. Ribbed bottom base design keeps food away from grease and excess liquid, increasing customer satisfaction and repeat sales.

16203057	<i>CNC6007</i>	32 oz., Medium	110/cs.
16209705	<i>YCNC6907D</i>	32 oz., Handled Chicken	110/cs.
16202543	<i>CNC6008</i>	50 oz., Medium, Zip Seal™	100/cs.
16202544	<i>CNC6003</i>	50 oz., X-Large	95/cs.



Non-Hinged Plastic Containers



A. CLEARVIEW™ MEDIUM PLATTER

PACTIV

Plastic bases with clear dome lids.

16202216	95970K	13 oz., 9" x 5 1/2" x 1 1/8", Platter Only, Black	600/cs.
----------	--------	---	---------

B. CLEARVIEW™ MICROMAX® CONTAINERS/LIDS

PACTIV

ClearView™ Micromax® containers are designed with both form and function in mind. These stylish black based containers come in a variety of convenient sizes that are perfect for reheatable sides and entrees.

Oval

16205512	CN85512	12 oz., 7 1/8" x 5 1/4" x 2 1/4", Black	250/cs.
16205516	CN85516	16 oz., 7 1/8" x 5 1/4" x 2 1/2", Black	250/cs.
16202792	CN85501	Dome Lid Fits 12 & 16 oz.	252/cs.
16202824	CN85502	Dome Lid Fits 24 oz., Clear	252/cs.

Rectangular

16202899	CN85008	8 oz., 5 7/8" x 4 7/8" x 1 1/4", Black	252/cs.
16202902	CN85012	12 oz., 5 15/16" x 4 15/16" x 2 1/6", Black	252/cs.
16200274	CN85016	16 oz., 7 1/2" x 6 7/16" x 1 1/2", Black	250/cs.
16202903	CN85024	24 oz., 7 1/2" x 6 7/16" x 1 15/16", Black	252/cs.
16205032	CN85032	32 oz., 7 1/2" x 6 7/16" x 2 1/4", Black	250/cs.
16202767	CN85101	Dome Lid Fits 8 & 12 oz.	252/cs.
16202772	CN85201	Dome Lid Fits 16, 24 & 32 oz.	252/cs.
16205201	CN85201	Dome Lid Fits 16, 24 & 32 oz.	250/cs.



C. DELITAINER® MICROWAVEABLE CONTAINERS/LIDS

PACTIV

Microwaveable, stackable, end-user reusable for the consumer and refrigerator-friendly. Leak resistant deli seal. Stackable lids and bases. Exceptional temperature endurance. Smoothwall design.

16202777	L2508B	8 oz., Black, Combo	240/cs.
16202532	L5008	8 oz., Clear, Bulk	480/cs.
16202523	L2508	8 oz., Clear, Combo	240/cs.
16202531	L5012Y	12 oz., Clear	480/cs.
16202535	L2512	12 oz., Clear, Combo	240/cs.
19512512	L2512	12 oz., Clear, Combo	250/cs.
16202539	SD5016	16 oz., Clear, Bulk	480/cs.
19515016	L5016	16 oz., Clear, Bulk	500/cs.
16202374	SD2516	16 oz., Clear, Combo	240/cs.
19512516	L2516	16 oz., Clear, Combo	250/cs.
16202537	L2524	24 oz., Clear, Combo	240/cs.
16203530	L5032	32 oz., Clear, Bulk	480/cs.
16203533	L2532	32 oz., Clear, Combo	240/cs.
16202536	NL500	Lid Fits L-2508, L-2512, L-2516, SD-2516, L-2524 & L-2532	480/cs.
19516065	NL640	Lid Fits L-2048 & L-2064	120/cs.
19516064	L6064	Lid Fits L-2064	120/cs.



D. REFLECTIONS® MICROWARE SUPREME™ RIB CONTAINER

PACTIV

Ribs/entrée container. Black base with clear dome lid.

16203325	57919MO	16 5/8" L x 7 3/8" W x 3"D, Full Slab	100/cs.
----------	---------	---------------------------------------	---------



Non-Hinged Plastic Containers



A. SHOWCASE® DELI PACKAGING

PACTIV

Clear plastic deli packaging.

Bases

16202454	CI85008	8 oz., Clear	1008/cs.
16202066	CI85024	24 oz., Clear	504/cs.
16202067	CI85032	32 oz., Clear	504/cs.
16201823	CI85048	48 oz., Clear	220/cs.
16201824	CI85064	64 oz., Clear	220/cs.
16201828	CI85430	(2) 4 1/2 oz./22 1/2 oz., 3-Compt., Clear	220/cs.

Lids

16205101	CI85101	Snap-On Dome Lid Fits 8, 12 & 16 oz., Clear	1000/cs.
16200576	CI85100	Snap-On Lid Fits 8, 12 & 16 oz., Clear	1000/cs.
16205202	CI85201	Snap-On Dome Lid Fits 24 & 32 oz., Clear	500/cs.
16202160	CI85201	Snap-On Dome Lid Fits 24 & 32 oz., Clear	504/cs.
16205200	CI85200	Snap-On Lid Fits 24 & 32 oz., Clear	500/cs.
16202138	CI85200	Snap-On Lid Fits 24 & 32 oz., Clear	504/cs.
16201826	CI85301	Snap-On Dome Lid Fits 48 & 64 oz., Clear	220/cs.
16201825	CI85300	Snap-On Lid Fits 48 & 64 oz., Clear	220/cs.

Combos

16206008	CI86008	8 oz., Clear, w/Flat Lid	250/cs.
16200574	CI86012	12 oz., Clear, w/Flat Lid	250/cs.
16200575	CI86016	16 oz., Clear, w/Flat Lid	250/cs.
16201830	CI86024	24 oz., Clear, w/Flat Lid	200/cs.
16201834	CI86032	32 oz., Clear, w/Flat Lid	200/cs.
16206064	CI86064	64 oz., Clear, w/Flat Lid	125/cs.



B. VERSATAINER® MICROWAVEABLE CONTAINERS

PACTIV NEWSPRING

Plastic bases with clear lids are stackable. One economical versatile container replaces all ordinary plastic, aluminum, styrofoam and paper products. Microwaveable, leak-resistant, reusable and dishwasher safe.

Rectangular

19510012	NC818B	12 oz., 4 1/2" x 5 1/2" x 1 3/4", Black	150/cs.
19510818	NC818	12 oz., 4 1/2" x 5 1/2" x 1 3/4", White	150/cs.
19510816	NC8168B	16 oz., 5" x 7 1/4" x 1 1/2", Black Base w/Clear Lid	150/cs.
19510838	NC838B	24 oz., 5" x 7 1/4" x 2", Black	150/cs.
19510839	NC838	24 oz., 5" x 7 1/4" x 2", White	150/cs.
19510627	NC626B	26 oz., 6 3/4" x 6 3/4" x 2"H, Black	150/cs.
19510028	NC868B	28 oz., 6" x 8 1/2" x 1 1/2", Black	150/cs.
19510868	NC868	28 oz., 6" x 8 1/2" x 1 1/2", White	150/cs.
19510013	NC8288B	30 oz. (2-Compt.), 6" x 8 1/2" x 1 7/8", Black	150/cs.
19510014	NC8288	30 oz. (2-Compt.), 6" x 8 1/2" x 1 7/8", White	150/cs.
19510333	NC333B	32 oz. (3-Compt.), 7 1/2" x 9 7/8" x 1 3/4", Black	150/cs.
19510637	NC636B	36 oz., 6 3/4" x 6 3/4" x 2 5/8"H, Black	150/cs.
19512888	NC888B	38 oz., 6" x 8 1/2" x 2", Black	150/cs.
19510889	NC888B	38 oz., 6" x 8 1/2" x 2", Black	300/cs.
19510888	NC888	38 oz., White Base w/Clear Lid	150/cs.
19510989	NC989B	58 oz., Black Base w/Clear Lid	150/cs.

Round

19510018	NC718B	16 oz., 6", Black	150/cs.
19510009	NC718	16 oz., 6", White	150/cs.
19510002	NC723B	24 oz., 7", Black	150/cs.
19510001	NC723	24 oz., 7", White	150/cs.
19510004	NC729B	32 oz., 7", Black	150/cs.
19510729	NC729B	32 oz., 7", Black	300/cs.
19510003	NC729	32 oz., 7", White	150/cs.
19519388	NC9388B	39 oz., 3-Compt., 9", Black	150/cs.
19510948	NC948B	48 oz., 9", Black	150/cs.
19510010	NC948	48 oz., 9", White	150/cs.



CONTAINERS & TRAYS

Non-Hinged Plastic Containers



CONTAINERS & TRAYS



A. SQUARE CONTAINERS/LIDS PACTIV-PWP

Reusable and re-sealable containers are stackable, space-saving and ideal for single-serve and Grab & Go™ applications.

Containers			
64930347	Y4S8	8 oz., 4" Square, Clear	1000/cs.
64930348	Y4S12	12 oz., 4" Square, Clear	1000/cs.
64930349	Y4S18	18 oz., 4" Square, Clear	750/cs.
64930352	Y4S24	24 oz., 4" Square, Clear	500/cs.
64930315	06S24	24 oz., 6" Square, Clear	300/cs.
64930354	Y4S32	32 oz., 4" Square, Clear	500/cs.
64930097	08S99	99 oz., 8 ⁵ / ₈ " x 8 ⁵ / ₈ " x 3 ¹ / ₂ ", Clear	100/cs.
Lids			
64930356	Y4SFL	Flat Recessed Fits 4", Clear, Leak Resistant	1000/cs.
64930060	06SFL	Flat Fits 6 ¹ / ₄ ", Clear	600/cs.
64930117	08SNL	Flat Fits 8 ³ / ₄ " x 8 ³ / ₄ ", Clear	200/cs.



B. DEL-PAK® COMBO-PAK® CONTAINERS W/LIDS PACTIV REYNOLDS

Del-Pak® polypropylene containers and lids keep foods fresh and flavorful. Del-Pak® containers outperform other plastic containers for oily and acidic foods-ideal for citrus fruit salads, gourmet peanut butter, Italian and Mexican sauces and salads made with mayonnaise. There's no taste or odor transfer. These containers are space savers with the faceted bottoms. One size lid fits 8, 12, 16 or 32 oz. containers. Custom printing up to six colors available.

17302080	RD208	8 oz., Clear	500/cs.
17302405	RDC208	8 oz., Natural, Combo	250/cs.
17302322	RD408	8 oz., White	500/cs.
17302160	RD216	16 oz., Clear	500/cs.
17302410	RDC216	16 oz., Natural, Combo	250/cs.
17302320	RD232	32 oz., Clear	500/cs.
17302323	RD432	32 oz., White	500/cs.



C. REFLECTIONS® MICROWARE SUPREME™ RIB CONTAINER PACTIV REYNOLDS

Ribs/entrée containers. Black base with clear dome lid.

17305791	57919MO	16 ⁵ / ₈ "L x 7 ⁹ / ₈ "W x 3"D, Full Slab	100/cs.
----------	---------	---	---------



D. DUAL OVENABLE TRAY SABERT

A CPET item that comes in a classic tray shape, used for many applications. Can be used in the oven up to 400°F for half an hour.

62208412	84127CPFSAM	12" x 7", 1-Compt., Black	150/cs.
----------	-------------	---------------------------	---------



E. MICROWAVABLE COMBO SABERT

Black base. Clear lid.

62200236	C72242BWM	2-Compt., 11" x 8" x 2 ¹ / ₂ "	150/cs.
----------	-----------	--	---------



F. OVENABLE COMBO CONTAINER SABERT

A CPET item that is specially designed for large cinnamon rolls. Can be used in the oven up to 400°F for half an hour.

62200226	C985038DWM	8 ¹ / ₂ " x 8 ¹ / ₂ ", Black/Clear	75/cs.
----------	------------	--	--------

Non-Hinged Plastic Containers



A. SANDWICH CONTAINER COMBO

SABERT

PET sandwich combo. Black and clear.

62200196 C900606F150N 6" x 6" 150/cs.



B. TRAY/LID

SABERT

Ovenable.

62204110 83127CPFS 12" x 7", 2-Compt., Black 150/cs.

62204111 54127FS Lid Fits 94127, 12" x 7", Clear 150/cs.



C. BARE® ECO-FORWARD® PLASTIC DELI CONTAINERS/LID SOLO®

Solo's premium Bare® RPET deli containers are made with 20% recycled content, delivering a sustainable option that environmentally conscious customers prefer. The containers' superb clarity enhances product appearance and impulse sales, while the durable, crack-resistant material serves a wide range of both hot and chilled foods. For streamlined operations, a common lid fits five convenient sizes that are easily stackable to reduce storage space.

18201562 DM8R0090 8 oz., RPET, Clear 500/cs.

18201730 DM12R0090 12 oz., RPET, Clear 500/cs.

18201560 DM16R0090 16 oz., RPET, Clear 500/cs.

18201577 LG8R0090 Recessed Lid Fits All, Clear 500/cs.



D. DELI GOURMET® FOOD CONTAINERS SOLO®

Lend a touch of class to your culinary creations. Their crystal-clear appearance puts a spotlight on anything they hold.

18200023 DM80090 8 oz., Clear, PET 500/cs.

18201015 DM120090 12 oz., Clear, PET 500/cs.

18201059 DM160090 16 oz., Clear, PET 500/cs.

18200321 DM32 32 oz., Clear, PET 500/cs.

E. EXPRESSIONS® CREATIVE CARRYOUTS® CONTAINER SOLO®

Two-piece container invites sales and provides a true straight-to-the-table experience. Square-shaped design creates a high-quality takeout container that complements any décor. Ideal for display, casual dine-in and to-go applications. Anti-fog lids resist fogging in both hot and cold applications. Microwarmable and microwavable. Heat lamp safe. Lids are vented to prevent steam build-up and popping open from steam pressure.

12600141 972012PM04 7½" x 7½" x 1", 7½" Base Only, Black 100/cs.



F. EXPRESSIONS® ECO™ BASES/LIDS SOLO®

Trendy, two-piece design made with environmentally friendly Ingeo™ plastic. Created from plants, not petroleum. ECO™ containers meet the ASTM Standards for Compostability as certified by the Biodegradable Products Institute. They biodegrade in a commercial compost facility within 60-180 days without releasing any toxic residues. Approved by Cedar Grove Composting, Inc., this innovative line of packaging is disposable with food waste; no separation is required!

Bases

12600021 0972013 7½" Base, Tan 300/cs.

12604015 0974015 9" Base, Tan 150/cs.

12601016 0976016 10¼", 3-Compt., Tan 130/cs.

Lids

12603016 0973016 Fits 7½", Clear 300/cs.

12603014 0973014 Fits 7½", Tan 300/cs.

12605016 0975016 Fits 9", Clear 150/cs.

12605014 0975014 Fits 9", Tan 150/cs.

12601018 0977018 Fits 10¼", Clear 130/cs.

12607014 0977016 Fits 10¼", 3-Compt., Tan 130/cs.





Non-Hinged Plastic & Hinged Foam Containers

CONTAINERS & TRAYS



A. MICROGOURMET® FOOD CONTAINERS/LIDS SOLO®

Busy operations will appreciate how this line allows prepackaged foods to be refrigerated and microwave-heated in the same container. Five different container sizes use one common lid. You also get excellent contact clarity with our translucent containers.

18200119	<i>MN8</i>	8 oz., Translucent	500/cs.
18201784	<i>MN16</i>	16 oz., Translucent	500/cs.
18200103	<i>16NW</i>	16 oz., White	500/cs.
18200118	<i>MN32</i>	32 oz., Translucent	500/cs.
18202423	<i>NL8RT7000</i>	Recessed Lid Fits 8-32 oz., Translucent	500/cs.



B. SOLOSERVE® PLASTIC DESSERT CUPS SOLO®

For establishments that feature a wide range of menu options, Solo® delivers the ultimate in flexibility. These versatile containers can be found in a variety of sizes and fit the bill for anything from fruit salads to snacks to desserts.

18205515	<i>SD35</i>	3½ oz., Clear	1000/cs.
18205500	<i>SD5</i>	5 oz., Clear	1000/cs.
18205505	<i>SD80090</i>	8 oz., Clear	1000/cs.
18205510	<i>SD12</i>	12 oz., Clear	1000/cs.
18202004	<i>SDL12</i>	Flat Top Dome Lid Fits 12 oz., PETE, Clear	1000/cs.



C. SUNDAE CUPS/LIDS SOLO®

Half the fun of serving ice cream treats is watching your customers' eyes light up when they see what's coming. So we make our sundae cups from PET to give your customers a better view.

18205880	<i>TS5</i>	5 oz.	1000/cs.
18205881	<i>TS9</i>	9 oz.	1200/cs.
18201035	<i>DL100</i>	Dome Lid Fits TS5, TP9 and TS9, Clear	500/cs.
18200024	<i>DL620</i>	Dome Lid Fits TS9, No Hole, Clear	25/100/cs.



D. DOME LIDS SOLO®

Flat top dome lid for TS5 dessert container. Use with containers SD5 and SD8.

18205520	<i>SDL58</i>	Fits TS5, SD5, SD8, Clear	1000/cs.
-----------------	--------------	---------------------------	----------



E. DELI CONTAINER/LID TRELIS EARTH®

We're proud of these and think that despite the fact that our corn polymers are not transparent (like others) they do hold up to boiling water and can go from the freezer to the microwave – so they are the answer to not just soups and prepared food, but bulk food sales and deli items too! Each size uses the same lid and it's a snug, well-engineered solution that takes bioplastic food containers to new heights.

C4780036	<i>WFR02</i>	16 oz., 5½" x 2½", Pint, White	600/cs.
C4780034	<i>WFR04</i>	Lid Fits Cup, Pint, Quart, 5½" x 2½", White	600/cs.

HINGED FOAM CONTAINERS



F. PRIME SOURCE® FOAM HINGED CONTAINERS PRIME SOURCE®

Foam hinged compartment containers.

75002901	<i>75002901</i>	6" x 6" x 3", Medium 1-Compt.	500/cs.
75002910	<i>75002910</i>	8" x 8½" x 3", Medium 1-Compt.	200/cs.
75002913	<i>75002913</i>	8" x 8½" x 3½", Medium 3-Compt.	200/cs.
75002904	<i>75002904</i>	9" x 9" x 3¼", Large 1-Compt.	200/cs.
75002905	<i>75002905</i>	9" x 9" x 3¼", Large 3-Compt.	200/cs.



G. FOAM HINGED LID CONTAINERS DART

Secure closure improves handling and helps protect against accidental openings. Foam insulation is ideal for transporting and storing both hot and cold foods.

12500060	<i>60HT1</i>	5⅞" x 6" x 3", 6" Large Sandwich, White	500/cs.
12500410	<i>95HT1</i>	9½" x 9½" x 3", Large, White	200/cs.
12500405	<i>95HT3</i>	9½" x 9¼" x 3", Large, 3-Compt., White	200/cs.
w/Removable Lids			
12500206	<i>85HT1</i>	8⅜" x 7⅞" x 3¼", Medium, White	200/cs.
12500207	<i>85HT3</i>	8⅜" x 7⅞" x 3¼", Medium, 3-Compt., White	200/cs.
12501204	<i>205HT1</i>	9¼" x 6⅞" x 2⅞", White	200/cs.

Hinged Foam Containers



A. FOAM HINGED CONTAINERS

GENPAK

Our foam hinged carryout and takeout containers include handy compartments for proper food storage and separation - perfect for use as doggie bags or other to go container needs. Keep your food fresh and temperature controlled with the foam hinged carryout containers from Genpak.

34782010	20010	9 ¹ / ₄ " x 9 ¹ / ₄ " x 3", Large, White	200/cs.
34780102	20010V	9 ¹ / ₄ " x 9 ¹ / ₄ " x 3", Large, Vented, White	200/cs.
34780150	20310	9 ¹ / ₄ " x 9 ¹ / ₄ " x 3", Large, 3-Compt., White	200/cs.
34780006	25000	10 ¹ / ₄ " x 9 ¹ / ₄ " x 3 ¹ / ₄ ", Jumbo, White	200/cs.
34780200	25300	10 ¹ / ₄ " x 9 ¹ / ₄ " x 3 ¹ / ₄ ", Jumbo, 3-Compt., White	200/cs.



B. HI-VOLUME FOAM HINGED CONTAINER

GENPAK

Hinged containers feature a stacking rim for safe handling of multiple meals, vapor control side seams to ensure freshness and super-secure locking systems to keep food in place.

34780100	23300	8 ⁷ / ₈ " x 9 ¹ / ₄ " x 3", Medium, 3-Compt., White	200/cs.
-----------------	-------	---	---------

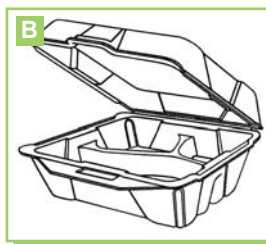

C. SNAP-IT® FOAM HINGED CONTAINERS

GENPAK

Hinged containers feature a stacking rim for safe handling of multiple meals, vapor control side seams to ensure freshness and super-secure locking systems to keep food in place.

34784028	22400	5 ¹ / ₈ " x 5 ³ / ₁₆ " x 2 ³ / ₄ ", Sandwich, Medium, White	500/cs.
34780129	22500SESAME	5 ¹ / ₈ " x 5 ³ / ₁₆ " x 3 ¹ / ₄ ", Sandwich, Large, Sesame	500/cs.
34780120	22500	5 ¹ / ₈ " x 5 ³ / ₁₆ " x 3 ¹ / ₄ ", Sandwich, Large, White	500/cs.
34780222	SN225BK	5 ¹³ / ₁₆ " x 5 ¹¹ / ₁₆ " x 3 ¹ / ₈ ", Large Sandwich, Black	500/cs.
34780224	SN225	5 ¹³ / ₁₆ " x 5 ¹¹ / ₁₆ " x 3 ¹ / ₈ ", Large Sandwich, White	500/cs.
34780177	SN227	6 ³ / ₈ " x 6 ⁷ / ₁₆ " x 2 ¹⁵ / ₁₆ ", Jumbo Sandwich, White	500/cs.
34782110	21100	7" x 3 ⁹ / ₁₆ " x 2 ¹ / ₄ ", Hot Dog, White	500/cs.
34782020	SN220	7 ⁵ / ₈ " x 8 ⁷ / ₁₆ " x 2 ³ / ₈ ", Small, White	200/cs.
34780223	SN223	7 ⁵ / ₈ " x 8 ⁷ / ₁₆ " x 2 ³ / ₈ ", Small, 3-Compt., White	200/cs.
34781103	SN103	7 ¹ / ₈ " x 8 ⁵ / ₈ " x 2 ¹ / ₂ ", Small, 3-Compt., White	200/cs.
34780113	SN240	8" x 8" x 3", Medium, White	200/cs.
34781431	SN2433L	8" x 8" x 3", Medium, 3-Compt., Black	200/cs.
34781430	SN243	8" x 8" x 3", Medium, 3-Compt., White	200/cs.
34784005	20400	8 ¹ / ₄ " x 5 ³ / ₁₆ " x 2", Medium Shallow, White	250/cs.
34782170	21700	8 ¹ / ₄ " x 5 ³ / ₁₆ " x 3", Medium, White	500/cs.
34782160	21600	8 ⁷ / ₁₆ " x 4 ³ / ₁₆ " x 3 ¹ / ₁₆ ", Hoagie, Medium, White	500/cs.
34782055	20500BK	9 ³ / ₁₆ " x 6 ¹ / ₂ " x 3 ¹ / ₁₆ ", Large, Black	200/cs.
34780110	20500	9 ³ / ₁₆ " x 6 ¹ / ₂ " x 3 ¹ / ₁₆ ", Large, White	200/cs.
34780181	SN200BK	9 ¹ / ₄ " x 9 ¹ / ₄ " x 3", Large, Black	200/cs.
34780176	SN200	9 ¹ / ₄ " x 9 ¹ / ₄ " x 3", Large, White	200/cs.
34782077	SN200V	9 ¹ / ₄ " x 9 ¹ / ₄ " x 3", Large, 1-Compt., Vented, White	200/cs.
34780182	SN203BK	9 ¹ / ₄ " x 9 ¹ / ₄ " x 3", Large, 3-Compt., Black	200/cs.
34780173	SN203	9 ¹ / ₄ " x 9 ¹ / ₄ " x 3", Large, 3-Compt., White	200/cs.
34782083	SN203V	9 ¹ / ₄ " x 9 ¹ / ₄ " x 3", Large, 3-Compt., Vented, White	200/cs.
34782190	21900	9 ¹ / ₂ " x 5 ¹ / ₄ " x 3 ¹ / ₂ ", Hoagie, Large, White	200/cs.
34781270	SN270	12 ¹⁵ / ₁₆ " x 9 ⁷ / ₈ " x 3 ³ / ₈ ", Super Jumbo, White	200/cs.
34784030	26600	13 ³ / ₁₆ " x 4 ¹ / ₂ " x 3 ¹ / ₈ ", Hoagie, X-Large, White	200/cs.



D. VALUEWARE FOAM HINGED CONTAINER

GENPAK

Lightweight, economical take-out container.

34782079	SN240VW	8" x 8" x 3", White	200/cs.
34782078	SN203VWH0183400	9 ¹ / ₄ " x 9 ¹ / ₄ " x 3", 3-Compt., White	200/cs.

E. DL (DOUBLE LAMINATED) HINGED FOAM CONTAINERS

PACTIV

Laminated on the inside and outside of the container for maximum heat tolerance and strength. Insulated to keep hot foods HOT and cold foods COLD. Double-slot closure.

16201506	YU80661CSUPC	Medium, 1-Compt.	150/cs.
16201451	Y80661	Medium, 1-Compt.	150/cs.
16201439	80215	Medium, 3-Compt. (Shallow)	150/cs.
16201453	80663	Medium, 3-Compt.	150/cs.
16201458	80581	Large, 1-Compt.	150/cs.
16201449	80583	Large 3-Compt.	150/cs.



Hinged & Non-Hinged Foam Containers

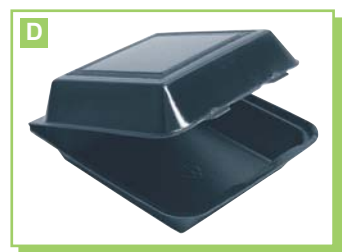
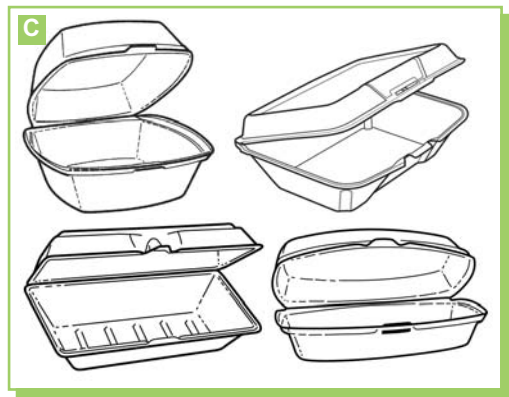

CONTAINERS & TRAYS

A. FOAM CLAMSHELLS PACTIV

Foam clamshells.

16201228	<i>HD1P8L1</i>	8" x 8", 1-Compt., Happy Face	150/cs.
16201229	<i>HD3P8L1</i>	8" x 8", 3-Compt., Happy Face	150/cs.

B. HINGED FOAM CONTAINERS PACTIV

Hinged containers with dual tab.

16202030	<i>TD18801</i>	8 ² / ₅ " x 8 ¹ / ₁₀ " x 3", Medium, 1-Compt.	150/cs.
16202053	<i>TD18803</i>	8 ² / ₅ " x 8 ¹ / ₁₀ " x 3", Medium, 3-Compt.	150/cs.
16202056	<i>TD19901</i>	9" x 9" x 3 ¹ / ₂ ", Large, 1-Compt.	150/cs.
16202036	<i>TD19903</i>	9" x 9" x 3 ¹ / ₂ ", Large, 3-Compt.	150/cs.

C. HINGED LID CONTAINERS PACTIV

Conventional white foam hinged lid containers.

16201542	<i>TH10079</i>	5 ¹ / ₈ " x 5 ¹ / ₈ " x 2 ¹ / ₂ ", Small Square	500/cs.
16201554	<i>TH10080</i>	6" x 6" x 3", Medium Square	500/cs.
16201544	<i>TH10081</i>	6 ³ / ₈ " x 6 ³ / ₈ " x 3", Large Square	500/cs.
16202311	<i>TH10098</i>	7 ¹ / ₄ " x 3" x 2", Small Sandwich	504/cs.
16202314	<i>TH10089</i>	9 ¹ / ₈ " x 6 ¹ / ₈ " x 3 ¹ / ₄ ", Large Deep	200/cs.
16202214	<i>TH10206</i>	9 ³ / ₁₆ " x 6 ¹ / ₂ " x 1 ⁵ / ₈ ", Large Shallow	150/cs.
16202213	<i>TH10205</i>	9 ³ / ₁₆ " x 6 ¹ / ₂ " x 2 ³ / ₄ ", Large Deep	150/cs.
16202809	<i>TH10099</i>	9 ³ / ₄ " x 5" x 3 ¹ / ₄ ", Large Deep	560/cs.

D. PLACESETTER® PREMIER FOOD CONTAINER PACTIV

Rich black color enhances all food presentations, superior high gloss appearance. Extra-sturdy double lamination, excellent for heavy product.

16201429	<i>TXB0901</i>	9" x 9", Large, Black	150/cs.
-----------------	----------------	-----------------------	---------

E. SMARTLOCK® HINGED LID CONTAINERS PACTIV

White Smartlock® foam hinged lid container. A smart choice for confidence that your container is securely closed.

16201540	<i>HLW0600</i>	5 ³ / ₄ " x 5 ³ / ₄ " x 3 ¹ / ₄ ", Medium Sandwich	504/cs.
16201381	<i>HLW0701</i>	7 ¹ / ₂ " x 8" x 2 ⁵ / ₈ ", Small	150/cs.
16201382	<i>HLW0703</i>	7 ¹ / ₂ " x 8" x 2 ⁵ / ₈ ", Small 3-Compt.	150/cs.
16201383	<i>HLW0801</i>	8" x 8 ¹ / ₂ " x 3", Medium	150/cs.
16201386	<i>HLW0803</i>	8" x 8 ¹ / ₂ " x 3", Medium 3-Compt.	150/cs.
16202205	<i>HLW0184</i>	8 ³ / ₄ " x 4 ¹ / ₂ " x 3 ¹ / ₈ ", Medium Sandwich	440/cs.
16202158	<i>HLW0188</i>	8 ³ / ₄ " x 5 ¹ / ₂ " x 3", Medium	220/cs.
16201390	<i>HLW0901</i>	9" x 9 ¹ / ₂ " x 3 ¹ / ₄ ", Large	150/cs.
16201393	<i>HLW0903</i>	9" x 9 ¹ / ₂ " x 3 ¹ / ₄ ", Large 3-Compt.	150/cs.
16202206	<i>HLW0189</i>	9 ⁵ / ₁₆ " x 6 ³ / ₁₆ " x 3 ¹ / ₄ ", Large Rectangular	220/cs.
16201640	<i>HLW1001</i>	9 ¹ / ₂ " x 10 ¹ / ₂ " x 3 ¹ / ₄ ", X-Large	250/cs.
16201646	<i>HLW1003</i>	9 ¹ / ₂ " x 10 ¹ / ₂ " x 3 ¹ / ₄ ", X-Large 3-Compt.	250/cs.

NON-HINGED FOAM CONTAINERS

F. FOOD CONTAINERS DART

Insulated foam containers keep food at its proper temperature. Nest closely to minimize cube and maximize storage space. Separate easily for quicker dispensing. Contains no CFCs.

12508084	<i>4J6</i>	4 oz., White	1000/cs.
12508086	<i>6SJ12</i>	6 oz. Squat, White	1000/cs.
12508108	<i>8SJ20</i>	8 oz. X-Squat, White	1000/cs.
12507220	<i>12SJ20</i>	12 oz. Squat, White	500/cs.
12500160	<i>16MJ32</i>	16 oz. X-Squat, White	500/cs.
12500156	<i>16MJ20</i>	16 oz. Squat, White	500/cs.
12505660	<i>24MJ48</i>	24 oz., White	500/cs.
12500188	<i>32MJ48</i>	32 oz., White	500/cs.

Non-Hinged Foam & Aluminum Take Out Containers



A. SMART-SET® HEXAGON SERVING TRAY/LID GENPAK

Insulates hot and cold food products better than solid plastic packaging. Unique hexagon, black design stands out for an upscale presentation. Anti-fog, crystal clear lid snaps on and seals the container. Stacking lid design for easy take out.

34780193	<i>HX0193L</i>	9"	200/cs.
34784709	<i>94709</i>	Lid Fits HX009-3L, HX019-3L, 9 ¹⁵ / ₃₂ " x 1 ²⁵ / ₃₂ ", Clear	200/cs.



B. HANDI-KUP® UNIVERSAL HOT/COLD FOOD CONTAINERS WINCUP

Smoothwall.

19400404	<i>F4</i>	4 oz., White	1000/cs.
19400407	<i>F6</i>	6 oz., White	1000/cs.
19401788	<i>F8</i>	8 oz. Squat, White	500/cs.
19400411	<i>F12</i>	12 oz., White	500/cs.
19400416	<i>F16</i>	16 oz., White	500/cs.
19401621	<i>F16HVY</i>	16 oz., White, Heavy-Duty	500/cs.
19400432	<i>F32</i>	32 oz., White	250/cs.



ALUMINUM TAKE OUT CONTAINERS

C. DOME LID DOUGLAS STEPHEN PLASTICS

For 10" round pan.

13000092	<i>LD38SP</i>	Dome Lid	250/cs.
-----------------	---------------	----------	---------



D. OBLONG CONTAINER W/LID HFA

Foil oblong pan for carryout applications. IVC rim.

31042035	<i>204535250W</i>	24 oz., 8 ¹ / ₂ " x 6 ³ / ₈ " x 1 ¹⁵ / ₃₂ ", 3-Compt., 35 GA	250/cs.
-----------------	-------------------	--	---------



E. ROUND CONTAINERS/LIDS HFA

Vertical hemmed edge rim.

31040035	<i>205830500</i>	37 oz., 8 ¹⁵ / ₁₆ " x 7 ¹ / ₃₂ " x 1 ⁹ / ₁₆ ", 30 GA	500/cs.
31040501	<i>204630500</i>	48 oz., 8 ⁹ / ₁₆ " x 1 ²¹ / ₃₂ ", 30 GA	500/cs.
31040036	<i>2058DL500</i>	Dome Lid Fits 2058	500/cs.
31042046	<i>2046DL500</i>	Dome Lid Fits 2046	500/cs.



F. ALUMINUM ROUND CONTAINERS/COVERS PACTIV

Aluminum round with hemmed edge.

16202667	<i>52730</i>	7", Round	250/cs.
16202382	<i>52725</i>	7", Round	250/cs.
16202524	<i>55830</i>	8", Round	250/cs.
16201811	<i>50930</i>	9", Round	300/cs.
16201039	<i>5731030</i>	10", Round	250/cs.
16206445	<i>L527</i>	Board Cover Fits 7"	500/cs.
16201866	<i>L509</i>	Board Cover Fits 9"	300/cs.
16202363	<i>P527</i>	Dome Cover Fits 7"	500/cs.
16202430	<i>P509S</i>	Shallow Dome Cover Fits 9"	300/cs.



G. CLASSIC CARRY-OUT® CONTAINERS PACTIV

Offer an upscale image for your Home Meal Replacement program that consumers find attractive and versatile. In addition, their heavy-duty aluminum protects food and preserves the quality of meat, seafood, prepared entrees, side dishes and bakery foods. Aluminum bases are 100% recyclable. Allows food to be prepared, stored, transported and reheated in the same container. Can be used for either hot or cold display applications. Compatible with heat-sealed film.

16202709	<i>6707WPSFG</i>	16 oz., 7 ⁹ / ₁₆ " x 5 ¹ / ₄ " x 1 ⁵ / ₁₆ ", Oval w/Dome Lid	100/cs.
16206709	<i>6708WPZFG</i>	22 oz., 8 ⁹ / ₁₆ " x 6 ³ / ₁₆ " x 1 ¹ / ₄ ", Black/Gold w/Flat Lid	100/cs.
16206708	<i>6708WPSFG</i>	22 oz., 8 ⁹ / ₁₆ " x 6 ³ / ₁₆ " x 1 ¹ / ₄ ", Black/Gold w/Dome Lid	100/cs.
16202624	<i>Y6710WPSFG</i>	46 oz., 9 ³ / ₄ " x 7 ³ / ₄ " x 1 ³ / ₄ ", Black/Gold w/Dome Lid	50/cs.



Aluminum Take Out & Bakery Containers



CONTAINERS & TRAYS



A. OBLONG PANS/COVERS

PACTIV

Interrupted vertical curl.

16202372	70530	1 lb.	1200/cs.
16202146	76830	1½ lb., Oblong Pan	400/cs.
16202715	74730	1½ lb., Oblong Pan	500/cs.
16202145	78830	2¼ lb., Oblong Pan	400/cs.
16202696	700240	3 lb., Oblong Pan	250/cs.
16202575	702145	4 lb., Oblong Pan	150/cs.
16203400	L788	Board Cover Fits 1½ lb. & 2¼ lb.	500/cs.
16207021	L7021	Board Cover Fits 4 lb.	250/cs.
16202148	YP768	Dome Cover Fits 768 to 788, 8⅝" x 5⅞" x 11/16"	800/cs.



B. THRIFT-PACK® CARRY OUT TRAY COMBO

PACTIV

Aluminum oblong carry out container with foil laminated board cover.

16202313	7139TP	8½" x 6½" x 1½", Hi-Divider 3-Compt.	200/cs.
----------	--------	--------------------------------------	---------



C. PIE PAN

HFA

Use with coordinating clear dome lids for premium presentation and easy transport.

31040503	400440500	9", Extra Deep, 40 GA	500/cs.
----------	-----------	-----------------------	---------



D. ANGEL FOOD PANS

PACTIV

Aluminum angel food pans.

16202365	42730	47¼ oz., 7", w/Metal Tube	200/cs.
16208201	4018WPPC	55 oz., 8", w/Preset Cup & Dome	100/cs.



E. HOLIDAY FOIL HEART PAN/LID

PACTIV

Foil heart pan.

16208850	605530DR	12 oz., 5⅝" x 5⅞" x 1½", Small, Red	100/cs.
16204634	P690	Deep Plastic Dome Cover Fits Large, 9⅞" x 9⅝" x 1½", Clear	100/cs.



F. LOAF PANS

PACTIV

Full curl rim. Aluminum.

16208857	61635	16 oz., 6⅞" x 3¾" x 2", 1 lb.	1000/cs.
16208824	63735	29 oz., 8" x 4¼" x 2⅞", 1½ lb.	500/cs.
16202695	60835	35⅞ oz., 8⅝" x 4½" x 2½", 2 lb.	300/cs.

Interrupted vertical curl rim.

16208805	79945	5 lb.	250/cs.
----------	-------	-------	---------



G. MUFFIN PANS

PACTIV

Aluminum muffin pans.

16202581	654835	4 ct., 5¼ oz.	200/cs.
16208870	654835	4 ct., 5¼ oz.	250/cs.
16208835	6951130	6 ct., 3⅞ oz.	500/cs.

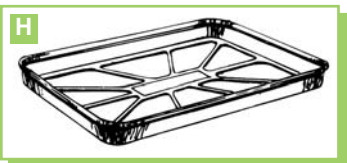

H. OBLONG DANISH PAN

PACTIV

Oblong Danish pan. Full curl rim.

16200629	62930	22 oz., 9½" x 6⅞" x ¾"	500/cs.
----------	-------	------------------------	---------

Aluminum Bakery & Steamtable Pans/Lids



A. PIE PLATES PACTIV

Aluminum pie plates.			
16202572	40525	7½ oz., Pot Pie	750/cs.
16202671	212630	9 oz., 6" Deep	800/cs.
16202592	25835	19½ oz., 8" X-Deep	400/cs.
16202569	21940	30 oz., 9" X- Deep	400/cs.
16202570	23045Y	32 oz., 9 ¹³ / ₁₆ " dia. x 1 ¹⁵ / ₆₄ "D, Extra Deep	400/cs.



B. SHEET CAKE PANS PACTIV

Aluminum sheet cake pan.			
16202522	6042WP	56½ oz., 12 ¹³ / ₁₆ " x 8 ¹³ / ₁₆ " x 3½", 1/4 Size, w/Dome Cover	60/cs.
16208818	614255	116 oz., 17 ⁵ / ₈ " x 12 ¹³ / ₁₆ " x 1¼", 1/2 Size	100/cs.

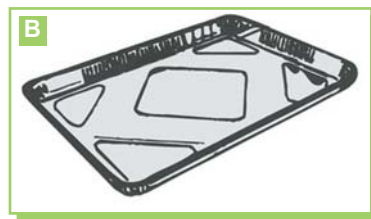

C. SIDEWALL PAN PACTIV

Danish ribbed sidewall pan. Full curl rim.			
16208848	600230	24½ oz., 12 ³ / ₈ " x 5 ³ / ₈ " x 1"	500/cs.



D. SQUARE CAKE PAN/LID PACTIV

Full curl rim.			
16202668	66435	8" Square	300/cs.
16201940	P664	Dome Lid, 8"	252/cs.



E. UTILITY CUPS PACTIV

Full curl rim. Aluminum.			
16208233	40225	2 oz.	2000/cs.
16206365	42330	4½ oz.	1000/cs.

F. WINDOW-PACK® SQUARE CAKE PAN PACTIV

Aluminum pan with clear plastic dome.			
16202672	664WP	8" Square	100/cs.



G. PIZZA PAN/LID REVERE PACKAGING

Full curl rim. Aluminum.			
58503150	361645BK	16", Black	125/cs.
58503153	P3113	Dome Lid Fits 13" Pizza Pan (Straight Wall)	125/cs.



ALUMINUM STEAMTABLE PANS/LIDS

H. STEAMTABLE PANS/LIDS HFA

Foil steamtable pans. Full curl rim.			
Pans			
31041100	402540100	1/3 Size, 107 oz., 40 GA	100/cs.
31049051	32135100	1/2 Size, 128 oz., 35 GA	100/cs.
31043214	32140100	1/2 Size, 128 oz., 40 GA	100/cs.
31047050	40207050	Full Size, 232 oz., 70 GA	50/cs.
31040055	20197050	Full Size, 343 oz., 70 GA	50/cs.
31049050	20190050	Full Size Deep, Economy	50/cs.
Lids			
31040061	204930100	Fits 1/2 Size, 30 GA	100/cs.
31042048	204900100	Fits 1/2 Size, 25 GA	100/cs.
31040052	20500050	Fits Full Size, Economy	50/cs.



I. STEAMTABLE PAN PACTIV

Pactiv's steamtable pans combine the strength, durability, and economy of an aluminum container for both hot and cold food presentations. Allows food to be prepared, heated, refrigerated, shipped and served all in the same pan. Ideal for main courses, casseroles, vegetables, side dishes, and desserts.			
16201764	6132L	1/2 Size Deep, 120 oz., 12 ³ / ₄ " x 10 ³ / ₈ " x 2 ⁴ / ₇ "	100/cs.



CONTAINERS & TRAYS

Steamtable Pans/Lids/Portion/Soufflé Cups



CONTAINERS & TRAYS

A. STEAMTABLE PANS

PACTIV

Aluminum steamtable pans combine strength, durability and economy for both hot and cold food presentations. Allows food to be prepared, heated, refrigerated, shipped and served all in the same pan.

16202705	6062XH	1/3 Size, Deep, X-Heavy	200/cs.
16201768	6012XH	1/2 Size, Shallow, X-Heavy	100/cs.
16201734	Y6112H	1/2 Size, Medium, Heavy	100/cs.
16201735	Y6112XH	1/2 Size, Medium, X-Heavy	100/cs.
16201730	6132H	1/2 Size, Deep, Heavy	500/cs.
16201737	6132XH	1/2 Size, Deep, X-Heavy	100/cs.
16201763	6132XHE	1/2 Size, Deep (Coated), X-Heavy	100/cs.
16202669	634260	1/2 Size, Extra Deep	100/cs.
16201733	6110XH	Full Size, Shallow, X-Heavy	40/cs.
16201721	6120XH	Full Size, Medium, X-Heavy	40/cs.
16201434	6050XH	Full Size, Deep, X-Heavy	40/cs.

B. STEAMTABLE PAN

PACTIV

Aluminum steamtable pan. Prepare, refrigerate, heat, ship and serve all in the same pan.

16202134	Y6050XH	Full Size, Deep, 346 oz., 3 ³ / ₈ "D	40/cs.
----------	---------	--	--------

C. STEAMTABLE PAN COVERS

PACTIV

Steamtable pan covers. Interrupted vertical curl rim.

16202980	101230	Fits 1/2 Size	100/cs.
16201432	112045	Fits Full Size	80/cs.

PORTION/SOUFFLÉ CUPS

D. CONEX® COMPLEMENTS PORTION CONTAINERS/LID

DART

Made of durable, crack-resistant polypropylene. Ideal for many dining and carryout applications.

12505131	200PC	2 oz., Clear	2500/cs.
12505133	400PC	4 oz., Clear	2500/cs.
12505136	400PCL	Lid Fits 325PC, 400PC, 550PC, Clear	2500/cs.

E. PORTION CUPS/LID

FABRI-KAL

One piece construction. Never get soggy. Odorless, tasteless plastic.

13300106	PC200	2 oz., Translucent	2500/cs.
13301504	PC550	5 1/2 oz., Translucent	2500/cs.
13301552	XL345PC	Fits PC325, PC325B, PC400, PC400B, PC550, Crystal Clear	2500/cs.

F. HARVEST® PAPER PLEATED PORTION CUPS

GENPAK

All natural and produced from renewable resources. Each item is BPI certified compostable

Feature tightly rolled rims, box pleats, convex bases. Retail pack options.

34785050	F050	1/2 oz., White	5000/cs.
34785075	F075	3/4 oz., White	5000/cs.
34785100	F100	1 oz., White	5000/cs.
34785125	F125	1 1/4 oz., White	5000/cs.
34785200	F200	2 oz., White	5000/cs.
34780325	F325	3 1/4 oz., White	5000/cs.
34785400	F400	4 oz., White	5000/cs.
34785550	F550	5 1/2 oz., White	5000/cs.

Portion/Soufflé Cups



A. SOUFFLÉ PORTION CUPS/LIDS GEORGIA-PACIFIC

Exceptional strength and versatility. Ideal for condiments, sauces, and side portions. Pre-portioning with soufflé cups help control costs and saves time and labor.

15000141	P010BB	1 oz., Translucent	4800/cs.
15000190	P020BLK	2 oz., Matte Black	2400/cs.
15000046	P020	2 oz., Translucent	2400/cs.
15000134	P040	4 oz., Translucent	2400/cs.
15000142	PL1	Lid Fits 3/4 - 1 1/4 oz., Translucent	4800/cs.
15000170	PL2C	Lid Fits 1 1/2 - 2 1/2 oz., Clear	2400/cs.
15000132	PL2	Lid Fits 1 1/2 - 2 1/2 oz., Translucent	2400/cs.
15000171	PL4C	Lid Fits 3 1/4 - 4 oz., Clear	2400/cs.



B. NATURE FRIENDLY® PLA PORTION CUPS/LIDS NATURE FRIENDLY PRODUCTS

Nature Friendly Products' 100% biodegradable and compostable PLA cold cups, lids and straws provide consumers with an eco-friendly alternative to traditional disposables. Made from corn-based PLA renewable resources, these products are completely compostable within 50-100 days in home and commercial composting facilities, and are non-toxic and superior in strength and performance.

C6938070	AP6260	2 oz.	2500/cs.
C6938071	AP78105	3 1/2 oz.	2500/cs.
C6938072	AP78130	4 1/2 oz.	2500/cs.
C6938075	L628K	Lid Fits 2 oz.	2500/cs.
C6938076	L789K	Lid Fits 3 1/2, 4 1/2 oz.	2500/cs.



C. EARTHCHOICE® PLA PORTION CUPS PACTIV

Made from a natural plastic material called Ingeo™, an ingenious new material made from plants instead of oil. This means that Ingeo™ is 100% annually renewable, and EarthChoice™ cups and lids are fully compostable in municipal and industrial facilities. Exceptional clarity makes drink identification easy and presents contents in an upscale way. Exceptional strength, durable, made tough for everyday demand. Custom printing available to communicate brand image.

16202561	YSPLA200EC	2 oz.	2400/cs.
16202562	YSPLA300EC	3 1/4 oz.	2400/cs.
16202565	YSPLA400EC	4 oz.	2400/cs.



D. ELLIPSO™ OVAL PORTION CUPS/LID PACTIV

Ellipso™ breaks away from conventional round portion cups with a wide oval opening. Its elegant design lets you enhance the presentation of your prized sauces. Ellipso™ offers exceptional benefits: microwaveable, stackable, reusable, economical, refrigerator-friendly.

19519001	E1002B	2 oz., Base, Black	1000/cs.
16202698	E502B	2 oz., Base/Lid Combo, Black	1000/cs.
16202699	E502	2 oz., Base/Lid Combo, Clear	1000/cs.
19510510	E503	3 oz., Base/Lid Combo, Clear	500/cs.
19510505	E504B	4 oz., Base/Lid Combo, Black	500/cs.
19510504	E504	4 oz., Base/Lid Combo, Clear	500/cs.
19511034	E1034LD	Lid Fits 3 & 4 oz., Clear	1000/cs.



E. PORTION CUP/LID PACTIV

Snap lock lids ensure that products travel well and resist leaking.

16202222	YS200	2 oz., Translucent, Use Lid H	2400/cs.
16202161	YLS2FR	Lid H	2500/cs.

F. SOUFFLÉ CUP/LID PACTIV-PWP

Plastic soufflé cup.

64935325	5PC3251	3 1/4 oz., Clear	500/cs.
64935326	5PL41	Lid Fits 3-4 oz. Cups	500/cs.



Portion/Soufflé Cups



A. SAUCES & SIDES CONTAINER

SOLO®

Let your customer dip everything from chips to wings to rings. Let them see your sides in a whole new light. Wide mouth opening. Sleek black polystyrene. Curved, "no corner" profile.
18201160 DSS20001 2½ oz., Black, Polystyrene 2500/cs.



B. SOLO® PLASTIC SOUFFLÉ PORTION CUPS/LIDS

SOLO®

The choices are plentiful with Solo® Plastic Soufflé Portion Cups and Lids. We offer several color options to allow you to match any décor or occasion. And to cater to your many needs, you can choose from a wide variety of sizes. All provide an excellent lid fit.

Cups

18204708	P050S0100	1/2 oz. Squat, Translucent	5000/cs.
18204711	P075S0100	3/4 oz. Squat, Translucent	5000/cs.
18204720	P0750100	3/4 oz., Translucent	5000/cs.
18200140	P1000100	1 oz., Translucent	5000/cs.
18204726	P1250100	1¼ oz., Translucent	5000/cs.
18204729	P1500100	1½ oz., Translucent	5000/cs.
18202607	B200EN0001	2 oz., Black	2500/cs.
18202605	B200RD0011	2 oz., Red	2500/cs.
182026065	B200N0100	2 oz., Translucent	250/cs.
18202606	B200N0100	2 oz., Translucent	2500/cs.
18204735	P2500100	2½ oz., Translucent	5000/cs.
18200874	P325E0001	3¼ oz., Black	2500/cs.
18200325	P3250100	3¼ oz., Translucent	2500/cs.
18200872	P400E0001	4 oz., Black	2500/cs.
18204741	P4000100	4 oz., Translucent	2500/cs.
18703653	UR550100	5½ oz., Translucent	2500/cs.



No Slot Lids

18204714	PL10090	Fits P050S, P075S, P100, P125, T125, P101, Clear	5000/cs.
18204600	PL20090	Fits P150, P200, P200R, P35A, P250, B200, B200R, TH200, TH250, TP35, 405PR, Clear	2500/cs.
18200041	PL40090	Fits P325W, P400, T325, T400, P325, Clear	2500/cs.

C. SOLO® TREATED PAPER SOUFFLE PORTION CUPS

SOLO®

While these soufflé portion cups work well for your customers, they're also an economical solution in the back-of-the-house. Chefs like to use these versatile cups as measuring tools.
18208230 4042050 4 oz., White, Plastic Sleeve Inner Packaging\$ 5000/cs.



D. SOLO® TREATED PAPER SOUFFLÉ PORTION CUPS

SOLO®

While these soufflé portion cups work well for your customers, they are also an economical solution in the back-of-the-house. Chefs like to use these versatile cups as measuring tools.

18202610	0502050	1/2 oz.	5000/cs.
18202612	0752050	3/4 oz.	5000/cs.
18202614	1002050	1 oz.	5000/cs.
18202617	1252050	1¼ oz.	5000/cs.
18202706	2002050	2 oz.	5000/cs.
18202619	3252050	3¼ oz.	5000/cs.
18208220	4502050	3½ oz., White, Chipboard Box Inner Packaging	5000/cs.
18202622	4002050	4 oz.	5000/cs.
18202625	5502050	5½ oz.	5000/cs.



E. SOUFFLÉ CUPS/LIDS

TRELLIS EARTH®

Perfect for showing you care about saving the environment across your entire food line.

C4780044	WFR05	2 oz.	2500/cs.
C4780041	WFR07	4 oz.	2500/cs.
C4780037	WFR06	Lid Fits 2 oz.	2500/cs.
C4780039	WFR08	Lid Fits 4 oz.	2500/cs.

Paper French Fry/To-Go Cups/Buckets/Tubs



PAPER FRENCH FRY/TO-GO CUPS

A. SOLO® GREASE RESISTANT CONTAINERS

SOLO®

Made from 99% plant-based renewable resources. ASTM-D6868 certified. Compostable in a commercial compost facility. Paperboard that is from Forest Stewardship Council (FSC) or Sustainable Forestry Initiative (SFI) certified fiber source. Reclosable for safe portability. Grease resistant to prevent leak-through.

18700896	<i>GF2400645</i>	2½ oz., Munchie Cup®, Paper Fold Top	1000/cs.
18700035	<i>GF3500645</i>	3½ oz., Munchie Cup®, Paper Fold Top	1000/cs.
18700045	<i>GF4500645</i>	4½ oz., Munchie Cup®, Paper Fold Top	1000/cs.
18701899	<i>GRS1200021</i>	12 oz., Great Fries®	1000/cs.
18701900	<i>GRS1600021</i>	16 oz., Great Fries®	1000/cs.



BUCKETS/TUBS

B. OCTAGONAL TUB/LID

PACTIV-PWP

Octagonal clear tub.

64937064	<i>07064</i>	64 oz., 6⅞" x 4¼", Clear	300/cs.
64937065	<i>070L</i>	Flat Lid Fits 7" Octagonal Tub, Clear	300/cs.



C. ROUND TUBS

PACTIV-PWP

Made from high-quality PETE. Crystal clear, strong, and eminently stackable.

64930015	<i>0732</i>	32 oz., 6⅝" x 2", Clear, Bulk	300/cs.
64930748	<i>0748</i>	48 oz., 6⅞" x 3⅜", Clear	300/cs.
64930764	<i>0764</i>	64 oz., 6⅞" x 4¼", Clear	300/cs.
64931175	<i>07564LRLTE</i>	64 oz., 7⅞" x 4⅜", Clear, 7½" Round, Tamper Resistant Tub, Leak Resistant Lid	105/cs.
64930749	<i>07FL</i>	Flat Lid Fits 7" Round, Clear	300/cs.



D. POPCORN BUCKETS

SOLO®

While they may never see their name in lights, our popcorn containers are stars in their own right. Few paper buckets are as sturdy and leak proof, keeping butter from soaking through onto the laps of their biggest fans.

18706304	<i>V2400061</i>	24 oz., Popcorn	1000/cs.
18700087	<i>V3200061</i>	32 oz., Popcorn	500/cs.
18706312	<i>VL32</i>	32 oz., Premiere	500/cs.
18706316	<i>VB4600059</i>	46 oz., Premiere	500/cs.
18706320	<i>VP8500061</i>	85 oz., Popcorn	150/cs.



E. SOLO® DOUBLE WRAPPED PAPER BUCKETS/LID

SOLO®

Unwaxed

Available with a clear dome or paper disc lid, this is a great option for dry snack items. We offer sizes up to 165 oz., so you'll have no problem answering even the biggest cravings.

18708530	<i>5T102050</i>	83 oz., White	100/cs.
18205429	<i>10T1N0198</i>	165 oz., White	100/cs.

Waxed

A convenient disposable twist on the classic hotel ice bucket. A favorite with hotel chains because they are less expensive than cleaning and replacing permanent buckets. Waxed containers are best for cold foods and are coated on both sides to provide a moisture barrier.

18200809	<i>5T300069</i>	83 oz., Marble	100/cs.
18708537	<i>5T3N0196</i>	83 oz., White	100/cs.
18707340	<i>10T300069</i>	165 oz., Marble	100/cs.
18703141	<i>10T3N0199</i>	165 oz., White	100/cs.

Finger Pull Vented Lid

Grease resistant paper bucket lids are ideal for fried chicken and other hot foods.

18200607	<i>10V19S02050</i>	Fits 10T1, 10T3, 10TR25, White	100/cs.
-----------------	--------------------	--------------------------------	---------



CONTAINERS & TRAYS

Paper Carry-Out Containers



PAPER CARRY-OUT CONTAINERS

A. OUR DELI® DELI BOX

PRIME SOURCE®

Fast top. Auto bottom. 100% recyclable.

77000001 77000001 2-3 pc., 7" x 4 1/4" x 2 3/4", Our Deli 200/cs.

B. BIO-PAK® FOOD CONTAINERS

FOLD-PAK

Microwavable, stackable, one-piece design requires no assembly. Poly-coated interior with clay-coated exterior. Leak resistant; holds foods, sauces, and gravies. Heat lamp resistant. Retains heat and vents steam effectively.

Black

26080030	01BPBLACKM	#1, 5" x 4 1/2" x 2 1/2"	450/cs.
26080008	03BPBLACKM	#3, 8 1/2" x 6 1/4" x 2 1/2"	200/cs.
26080007	04BPBLACKM	#4, 8 1/2" x 6 1/4" x 3 1/2"	160/cs.
26080410	08BPBLACKM	#8, 6" x 4 3/4" x 2 1/2"	300/cs.

White

26089804	01BPWHITEM	#1, 5" x 4 1/2" x 2 1/2"	450/cs.
26080001	BP1WHT	#1, 32 oz., Squat	450/cs.
26080002	BP2WHT	#2, 48 oz., Squat	200/cs.
26089604	02BPWHITEM	#2, 8 1/2" x 6 1/4" x 1 7/8"	200/cs.
26089800	03BPWHITEM	#3, 8 1/2" x 6 1/4" x 2 1/2"	200/cs.
26089810	04BPWHITEM	#4, 8 1/2" x 6 1/4" x 3 1/2"	160/cs.
26080015	05BPWHITEM	#5, 9" x 9" x 2 1/2"	140/cs.
26080010	06BPWHITEM	#6, 9 1/4" x 9 1/4" x 3 1/2"	120/cs.
26089807	07BPWHITEM	#7, 9 1/2" x 9 1/2" x 4 1/2"	100/cs.
26080400	08BPWHITEM	#8, 6" x 4 3/4" x 2 1/2"	300/cs.
26089855	09BPWHITEM	#9, 6" x 4 3/4" x 2 1/2"	200/cs.

C. BIO-PLUS® EARTH® FOOD CONTAINERS

FOLD-PAK

Microwavable, stackable, one-piece design requires no assembly. 100% recycled paperboard with a minimum of 35% post-consumer recycled content. Leak resistant; holds foods, sauces, and gravies. Heat lamp resistant. Retains heat and vents steam effectively.

26080043	01BPEARATHM	#1, 5" x 4 1/2" x 2 1/2", Kraft	450/cs.
26080067	02BPEARATHM	#2, 8 1/2" x 6 1/4" x 1 7/8", Kraft	200/cs.
26080042	03BPEARATHM	#3, 8 1/2" x 6 1/4" x 2 1/2", Kraft	200/cs.
26088001	04BPEARATHM	#4, 8 1/2" x 6 1/4" x 3 1/2", Kraft	160/cs.
26088000	08BPEARATHM	#8, 6" x 4 3/4" x 2 1/2", Kraft	300/cs.
26081000	08BPSONOMM	#8, 6" x 4 3/4" x 2 1/2", Sonoma	300/cs.

D. FOLD-PAK® FOOD PAILS

FOLD-PAK

Paperboard food pails (microwavable).

w/Handle

26089620	08WHWHITEM	8 oz. (1/2 Pint), White	500/cs.
26089622	16WHWHITEM	16 oz. (Pint), White	500/cs.
26080005	32WHWHITEM	32 oz. (Quart), White	500/cs.
26089631	64WHXHWHM	64 oz., White, Extra Heavy	200/cs.

w/o Handle

26089639	08MWPAGODM	8 oz. (1/2 Pint), Pagoda Design (Red/White)	450/cs.
26089773	16MWPAGODM	16 oz. (Pint), Pagoda Design (Red/White)	450/cs.
26083232	16MWWHITEM	16 oz. (Pint), White	450/cs.
26089641	26MWPAGODM	26 oz., Pagoda Design (Red/White)	450/cs.

w/o Handle Available West Coast Only

26087591	16MWDRAAGM	16 oz. (Pint), Phoenix & Dragon	450/cs.
26087494	26MWDRAAGM	26 oz., Phoenix & Dragon	450/cs.

E. CARRYOUT BOX

SOUTHERN CHAMPION TRAY

Automatic, one piece design. Bleached sulphate (dual white) board.

18407638 2717 7" x 4 1/2" x 2 3/4", Snack Tuck Top, White 500/cs.

CONTAINERS & TRAYS



Pizza Packaging/Produce Basket/Paper Food Trays



PIZZA PACKAGING

A. PRIME SOURCE® PIZZA STAX LID SUPPORTS PRIME SOURCE®

Plastic pizza box lid supports.

76002501	76002501	Green	1000/cs.
76002500	76002500	White	1000/cs.



B. PIZZA CLAMSHELLS DOPACO

Hinged, nested clamshell is easy-to-use and easy-to-store.

66376977	5583	18/6 Slice Size, 10 ³ / ₁₆ " x 9 ¹³ / ₃₂ " x 1 ⁵ / ₈ ", Fresh Hot Pizza	220/cs.
66373703	3703	18/6 Slice Size, 10 ³ / ₁₆ " x 9 ¹³ / ₃₂ " x 1 ⁵ / ₈ ", White	220/cs.



C. TAKEOUT CARTON GEORGIA-PACIFIC

Polycoated pizza slice carton.

15009692	SC001	7 ¹ / ₄ " x 6" x 1 ³ / ₄ ", Small, Italian	500/cs.
----------	-------	--	---------



D. CLASSIC STONEWARE® ROUND PIZZA TRAYS PACTIV

Dual ovenable paperboard can be used in a microwave or conventional oven at temperatures up to 400°F for 60 minutes.

16201056	PCS01305	For 12" Pizza, White	250/cs.
16201055	PCS01505	For 14" Pizza, White	250/cs.



PRODUCE BASKET

E. THE GARDEN PARTY® BERIGARD BERRY BASKET PACTIV

Molded fiber berry basket. Berigard® berry baskets are ideal for all kinds of berries (strawberries, raspberries, blueberries). Molded fiber is the natural choice to absorb the excess juices from produce and display that farm fresh image.

16200314	M336184	1 qt., 5 ¹ / ₂ " x 5 ¹ / ₂ " x 3 ¹ / ₄ ", Green	250/cs.
----------	---------	---	---------



PAPER FOOD TRAYS

F. ECOCRAFT® FOOD TRAYS BAGCRAFT/PAPERCON

Made from recycled natural kraft paper stock using an FDA approved, chlorine-free manufacturing process.

10906990	300699	3 lb.	500/cs.
10900390	300700	5 lb.	500/cs.



G. FOOD TRAYS DOPACO

Serve big or small portions in this wide range of food trays. Clay coated. Compostable.

66375811	5811	4 oz., #25, Basketweave	1000/cs.
66375802	5802	6 oz., #40, Basketweave	1000/cs.
66375803	5803	8 oz., #50, Basketweave	1000/cs.
66375804	5804	1 lb., #100, Basketweave	1000/cs.
66375814	5814	2 lb., #200, Basketweave	1000/cs.
66375813	5813	2 ¹ / ₂ lb., #250, Basketweave	500/cs.
66375815	5815	3 lb., #300, Basketweave	500/cs.
66375817	5817	5 lb., #500, Basketweave	500/cs.
66375877	5877	5" x 1 ³ / ₄ " x 1 ⁷ / ₁₆ ", Hot Dog, Basketweave	1000/cs.





Paper Food Trays

CONTAINERS & TRAYS



A. FLUTED HOT DOG TRAYS GEORGIA-PACIFIC

Paper hot dog tray.

15008050	<i>HD8050</i>	8", White, Mediumweight	3000/cs.
15002210	<i>HD8075</i>	8", White, Heavyweight	3000/cs.



B. FOOD TRAYS GEORGIA-PACIFIC

Made from a sheet of clay-coated board. The one-piece construction results in an economical open-top container to serve a wide variety of uses.

15001605	<i>RP408</i>	6 oz., Red Plaid	4/250/cs.
15005220	<i>RP50</i>	1/2 lb., Red Plaid	1000/cs.
15005204	<i>RP1008</i>	1 lb., Red Plaid	1000/cs.
15005205	<i>RP1008</i>	1 lb., Red Plaid	4/250/cs.
15005211	<i>RP2008</i>	2 lb., Red Plaid	1000/cs.
15005215	<i>RP3008</i>	3 lb., Red Plaid	500/cs.
15005212	<i>RP3008</i>	3 lb., Red Plaid	500/cs.
15005225	<i>RP500</i>	5 lb., Red Plaid	500/cs.



C. CARRYOUT TRAY GRAPHIC PACKAGING INTL

Natural chipboard. Made from tan bending chip, a type of recycled sheet.

13403825	<i>20013525</i>	10 1/2" x 10 1/2" x 3 3/4"	200/cs.
-----------------	-----------------	----------------------------	---------



D. SAVADAY® MOLDED FIBER FOOD TRAYS HUHTAMAKI

Made from natural molded fiber which absorbs excess oils from fried food. Using Savaday food trays during food preparation can reduce grease spillage on kitchen floors. Helps keep grease out of kitchen drains.

15302815	<i>10404</i>	5 1/2" x 7 1/2", #200, Natural, Joy	4/250/cs.
15302805	<i>10408</i>	6" x 4", #50, Natural, Jump	1000/cs.
15302810	<i>10403</i>	7" x 5", #100, Natural, Jess	1000/cs.
15302820	<i>10405</i>	9" x 7", #300, Natural, Just	500/cs.



E. FOOD TRAYS SOUTHERN CHAMPION TRAY

One piece nested, SBS, packed in white corrugated.

18406516	<i>0401</i>	1/4 lb., #25, Red Check	4/250/cs.
18406519	<i>0413</i>	1 lb., #100, Red Check	4/250/cs.
18406521	<i>0417</i>	2 lb., #200, Red Check	4/250/cs.
18406522	<i>0425</i>	3 lb., #300, Red Check	500/cs.
18406523	<i>0429</i>	5 lb., #500, Red Check	500/cs.



F. METRIC FOOD TRAYS SUPERIOR QUALITY PACKAGING

Red plaid paper food trays.

64728708	<i>8708</i>	5 3/8" x 3 3/4" x 1 1/4", #50, Red/White	1000/cs.
64728701	<i>8701</i>	5 3/4" x 3 1/2" x 1 1/2", #100, Red/White	1000/cs.
64728702	<i>8702</i>	6 1/2" x 4 3/4" x 1 3/4", #200, Red/White	1000/cs.
64728703	<i>8703</i>	7 5/8" x 5 1/4" x 1 7/8", #300, Red/White	1000/cs.
64728705	<i>8705</i>	8 15/16" x 6 1/2" x 2 1/8", #500, Red/White	500/cs.



G. NATURE FRIENDLY® TRAYS NATURE FRIENDLY PRODUCTS

Nature Friendly Products' 100% biodegradable and compostable tableware provides consumers with an eco-friendly alternative to traditional disposables. Made from sugar cane bagasse-based renewable resources, they are completely compostable within 50-100 days in home and commercial composting facilities. These products are superior in strength and performance. Non-toxic, hot/cold tolerant, oil and water resistant, microwave and freezer safe.

C6934001	<i>T002</i>	9 1/5" x 6 3/5"	500/cs.
-----------------	-------------	-----------------	---------

School Lunch Trays



SCHOOL LUNCH TRAYS

A. NATURAL BROWN TRAY BRIDGE-GATE ALLIANCE GROUP

Compostable serving ware. Molded fiber pulp product with environmentally advanced technologies, conserving energy and water. Starting with the purest raw materials, the natural by-products of agricultural waste, Bridge-Gate employs a proprietary, self-contained washing and Biopulping process, minimizing ecological impact from field to factory to foodservice. With Bridge-Gate, you and your customers can be assured of compostable, consistently top-quality products that have been produced with the utmost concern for the environment.

B7280014 *BGW108T* 10¹/₂" x 8¹/₂" x 1", 5-Compt. 500/cs.



B. SCHOOL SERVING TRAY GENPAK

Genpak compartment lunch trays are second to none in quality and functionality. With five and six compartments, our school meal trays are durable and secure enough for hot and cold foods. Our trays are ideal for cafeteria and commissary use. Great for separating dressings and sauces from breads and pasta, our lunch trays will help keep your meal fresh and appetizing.

34780033 *10500* 10³/₈" x 8¹/₂" x 1³/₁₆", 5-Compt., White, Sesame 500/cs.



C. CHINET® MOLDED FIBER CAFETERIA TRAYS HUHTAMAKI

Sturdy, easy to handle trays that are made of 100% pre-consumer recycled fiber. Molded fiber is good for the table and good for the earth.

15306320 *22025* 8¹/₂" x 10¹/₂", 5-Compt., White, Valley 500/cs.

15306310 *22021* 8¹/₂" x 12¹/₂", 6-Compt., White, Valise 500/cs.



D. SAVADAY® MOLDED FIBER FOOD & BEVERAGE CARRIERS HUHTAMAKI

Molded fiber food and beverage trays made of 100% recycled fiber. Cup wells are designed to firmly grip cups which reduces spills. One-piece construction requires no set up time.

One-cup carrier with food tray. Fits 8-22 oz. cups.

15300962 *20962* 13" x 10" x 2", White, Flag 200/cs.

15301665 *20961* 15" x 11" x 2" Beige, Focus 200/cs.



E. SCHOOL TRAY HUHTAMAKI

Molded fiber school lunch trays are a great alternative to foam lunch trays.

15301012 *21012* 8³/₄" x 10³/₈" x 2", 5-Compt. 500/cs.

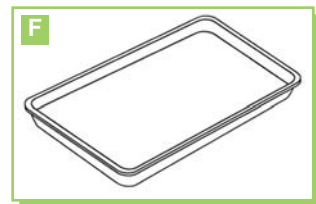

F. SERVICEWARE® MOLDED FIBER FLAT TRAYS HUHTAMAKI

Molded fiber items are molded paper fiber formed into uniquely shaped products to assure strength and rigidity in foodservice operations.

15301605 *20918* 9" x 7" x 1", Beige, Factor 500/cs.

15305835 *20815* 12" x 9" x 1", Beige, Tug 250/cs.

15305830 *20802* 12" x 9" x 1", White, Turret 250/cs.

15300020 *20803* 12" x 16", White, Fall 200/cs.

15301620 *20804* 14" x 18", White, Farm 100/cs.

G. NATURE FRIENDLY® TRAYS NATURE FRIENDLY PRODUCTS

100% biodegradable and compostable tableware provides consumers with an eco-friendly alternative to traditional disposables. Made from sugar cane bagasse-based renewable resources, they are completely compostable within 50-100 days in home and commercial composting facilities. Superior in strength and performance. Non-toxic, hot/cold tolerant, oil and water resistant, microwave and freezer safe.

C6934006 *T009* 8¹/₂" x 10¹/₂", 5-Compt. 500/cs.



H. PLACESETTER® DELUXE FOAM SERVING TRAY PACTIV

Premium quality laminated foam construction.

16200092 *TK10136* 14" x 18", White 100/cs.



I. SCHOOL LUNCH TRAYS PACTIV

Foam school lunch trays.

16203055 *TH10500* 8¹/₄" x 10¹/₄", 5-Compt., White 500/cs.

16200306 *TH10601* 8¹/₂" x 11¹/₂", 6-Compt., White 500/cs.



School Lunch Trays/Beverage/Drink Carriers



A. STAINWARE® NON-LAMINATED TRAY **PACTIV**
 Satin non-laminated foam lunch tray.
 16200265 TH10034 9" x 12", White 250/cs.

BEVERAGE/DRINK CARRIERS



B. CARRIER **DOPACO**
 Cup carrier.
 66372370 2370 7" x 3³/₁₆" x 9⁵/₁₆", Up to 32 oz.; 2/4 Cups, Handled 250/cs.



C. DIXIE® DRINK CARRYOUT TRAY **GEORGIA-PACIFIC**
 Multi-purpose and very economical. Strong and sturdy for all beverage sizes. Stores flat so it occupies little storage space. Auto-fold construction for easy set-up.
 15007785 4DCKDR 4-Drink, Kraft 200/cs.



D. STRONGHOLDER® MOLDED FIBER BEVERAGE CARRIERS **HUHTAMAKI**
 Molded fiber beverage carriers, made of 99% reclaimed fiber, are famous for their unmatched strength. Molded fibers are good for the table and good for the earth. Extra-strong grease absorbers.
 15300963 20963 6¹/₄" x 9³/₄" x 2", 2-Cup Carrier, 8 to 44 oz., Fusion 300/cs.
 15301650 20972 8¹/₄" x 8¹/₄" x 1⁵/₈", 4-Cup Carrier, 8 to 22 oz., Flurry - C 300/cs.
 15300945 20945 8¹/₂" x 8¹/₂" x 1³/₄", 4-Cup Carrier, 8 to 32 oz., Field 200/cs.
 15300221 20994 8¹/₂" x 8¹/₂" x 1³/₄", 4-Cup Carrier, 8 to 32 oz., Flight 300/cs.
 15302178 20985 10⁵/₈" x 10⁵/₈" x 2⁴/₅", 4-Cup Carrier, 8 to 46 oz., Frank 100/cs.



E. STRONGHOLDER® MOLDED FIBER FOOD & BEVERAGE CARRIERS **HUHTAMAKI**
 Molded fiber food and beverage trays made of 100% recycled fiber are famous for their unmatched strength. Cup wells are designed to firmly grip cups which reduces spills. One-piece construction requires no set up time. With food tray. Beige.
 15301640 20974 9³/₄" x 8³/₈" x 1⁵/₈", 2-Cup, 8 to 22 oz., Flow 400/cs.
 15300202 20975 9³/₄" x 8³/₈" x 1⁵/₈", 2-Cup, 8 to 22 oz., Narrow, Forum 250/cs.
 15301635 20969 13" x 8³/₈" x 1¹/₂", 4-Cup, 8 to 22 oz., Narrow, Fond 250/cs.
 15300990 20990 14⁷/₈" x 11¹/₂" x 2¹/₁₆", 2-Cup., 8 to 44 oz., Wide, Film 100/cs.
 15300024 20968 17⁵/₁₆" x 10³/₄" x 2¹/₈", 4-Cup, 8 to 44 oz., Wide, Fluid 150/cs.



F. CARRY-SAFE® CARRY OUT TRAYS **PACTIV**
 Molded fiber carry out trays.
 16202506 M527543 8" x 13", 8 to 24 oz. Cups, 4-Cup 210/cs.
 16202373 M527535 9⁷/₈" x 8⁵/₈" x 1³/₄", 8 to 24 oz. Cups, 2-Cup 200/cs.



G. CARRY-SAFE® CRUISER MOVER™ BEVERAGE CARRIER **PACTIV**
 Molded fiber four-cup beverage carrier. Carry-Safe® cup and beverage carriers are made from 100% recycled paper (mostly newsprint). They can carry beverages only or food and beverages. They hold a wide variety of cup sizes from 8 oz. to 32 oz. Strong and ready-to-use with no set up required to speed your customers on their way.
 16203521 M510032 8 to 32 oz. Cups 300/cs.



H. DRINK CARRIER **SOUTHERN CHAMPION TRAY**
 Automatic carrier with handle. Packed in corrugated.
 18402788 2788 7" x 7¹/₄" x 9¹/₄", 4 Cup (32 oz.) 250/cs.

Caterware



CATERWARE

A. PRIME SOURCE® ALUMINUM PARTY TRAYS

PRIME SOURCE®

Aluminum tray. Sturdy construction and nesting design for stacking.

75003731	75003731	12" dia., Flat, Embossed	25/cs.
75003733	75003733	12" dia., 5-Compt., Embossed	25/cs.
75003737	75003737	16" dia., Flat, Embossed	25/cs.
75003739	75003739	16" dia., 5-Compt., Embossed	25/cs.
75003750	75003750	18" dia., 6-Compt., Embossed	25/cs.



B. CATERWARE® DELUXE EMBOSSED TRAYS

PACTIV

Deluxe embossed trays.

Flat Trays

16208221	451212A	12" dia., Aluminum	50/cs.
16208240	451612A	16" dia., Aluminum	50/cs.
16208254	451812A	18" dia., Aluminum	50/cs.

Lazy Susan

16208209	441610A	16" dia., 5-Compt., Aluminum	50/cs.
----------	---------	------------------------------	--------



C. CATERWARE® TRAYS

PACTIV

Trays with Rosedome dome.

16202241	NLP12FB225R	12" dia. Flat Base, 2 1/4" H Dome	25/cs.
16202737	NLP12LB350R	12" dia. Lazy Susan Base, 3 1/2" H Dome	30/cs.
16202748	NLP16FB400R	16" dia. Flat Base, 4" H Dome	25/cs.
16203495	NLP16B400R	16" dia. Lazy Susan Base, 4" H Dome	25/cs.
16200235	NLP18B450R	18" dia. Lazy Susan Base, 4 1/2" H Dome	25/cs.



D. HEXQUISITE™ CATERING TRAY

PACTIV

Disposable catering tray with clear plastic dome cover.

16206018	966018KWP	18" dia., Black/Clear	25/cs.
----------	-----------	-----------------------	--------



E. SMARTLOCK® CATERWARE® TRAYS/LIDS

PACTIV

SmartLock® closure is an easy way to secure dome to tray. Secure nesting design keeps trays stacked and prevents shifting. Thumb tab enables quick and easy opening.

16209812	9812K	12", Flat Tray	50/cs.
16203455	9816K	16", Flat Tray	50/cs.
16206914	9818K	18", Flat Tray	50/cs.
16206905	P9812	Dome Lid, 12" x 3 1/2" H	50/cs.
16206906	P9816	Dome Lid, 16" x 3 1/2" H	50/cs.
16206904	P9818	Dome Lid, 18" x 4" H	50/cs.



F. SMARTLOCK® CATERWARE®

SCALLOP RIM COMBO FLAT TRAYS

PACTIV

In convenient combo packs, Pactiv SmartLock® Caterware® Trays are designed to nest and stack. The SmartLock® Closure makes these trays easy-to-open and close, and the lid remains attached even if cracking occurs.

16209813	9812KWP	12" dia., Black/Clear	25/cs.
16206915	9816KWP	16" dia., Black/Clear	25/cs.
16206916	9818KWP	18" dia., Black/Clear	25/cs.



G. CATERWARE® CRYSTAL CUT CLEAR

PLASTIC DOME COVERS

PACTIV

Clear plastic domes fit aluminum and plastic Caterware® trays.

16204603	P4412	12" dia. x 2 1/2" D	50/cs.
16204609	P4416	16" dia. x 2 1/2" D	50/cs.
16204615	P4418	18" dia. x 2 1/2" D	50/cs.



CONTAINERS & TRAYS

Caterware

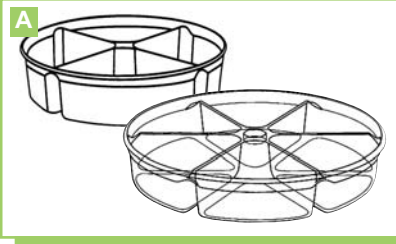

A. COMPARTMENTED TUBS PACTIV-PWP

Compartmented tubs.

64930733	<i>07324C</i>	32 oz., 6 ⁷ / ₈ " x 2", 4-Compt., Clear	300/cs.
64931067	<i>10646C</i>	64 oz., 9 ³ / ₄ " x 2", 6-Compt., Clear	100/cs.

B. COMPARTMENT PLATTER COMBO PACTIV-PWP

13" clear platter with 12 oz. dip cup and lid. 2¹/₂" deep. Four cells with juice trap.

64933257	<i>1325DD4CJLD</i>	12 ³ / ₄ " x 2 ¹ / ₂ "	50/cs.
-----------------	--------------------	--	--------



C. ENTERTAINWARE™ PARTY PLATTER PACTIV-PWP

Round swirl leak resistant dome with black base and standard 8 oz. deli cup dip holder.

64931313	<i>13PP20SLT</i>	12 ¹ / ₇ " x 2", Clear, 12" Platter Combo	50/cs.
-----------------	------------------	---	--------

D. BOWL COMBO PACTIV-PWP

80 oz. smooth clear bowl, flat inside lid fit (leak resistant).

64930279	<i>1080PIL90</i>	80 oz., 9 ³ / ₄ " x 3 ¹ / ₂ "	50/cs.
-----------------	------------------	---	--------



E. CATERWARE® CATERBOWL® SERVING BOWLS/LIDS PACTIV

Disposable serving bowls.

16209020	<i>92220K</i>	5 lb., 12 ¹ / ₈ " x 2 ¹ / ₄ ", Black	25/cs.
16209030	<i>92230K</i>	10 lb., 14 ³ / ₈ " x 2 ⁵ / ₇ ", Black	25/cs.
16209021	<i>P92220</i>	Dome Lid Fits 5 lb., 12 ¹ / ₇ " x 2 ³ / ₈ ", Clear	25/cs.
16209031	<i>P92230</i>	Dome Lid Fits 10 lb., 14 ¹ / ₈ " x 2 ³ / ₈ ", Clear	25/cs.

F. ROSEWARE® BOWL/LID COMBO PACTIV

Made of high clarity APET. Design and material combine to provide high leak resistance and cold temperature performance.

16202580	<i>LRW48140</i>	48 oz., 9 ³ / ₄ " dia.	140/cs.
-----------------	-----------------	--	---------



G. MOZAIK® SQUARE PLATTER COMBO SABERT

From top to bottom, Mozaik® trays and lids offer a sleek, contemporary design. Smooth crystal clear lids and gloss trays are the perfect combination of style and class. Give your customers a unique experience, from your food to the tray that it is served on. Mozaik® trays make your food look great!

62209311	<i>C9311</i>	10", Black/Clear	25/cs.
62209314	<i>C9314</i>	14 ¹ / ₈ ", Black, w/5614 Crystal Clear Dome Lid	25/cs.
62209316	<i>C9316</i>	16", Black, w/5616 Crystal Clear Dome Lid	25/cs.



H. NOVA FLAT PLATTERS SABERT

Flat black platters.

62200046	<i>C912</i>	12" dia., Combo, 25 ct., Black	25/cs.
62209512	<i>C9512</i>	12" dia., Combo, Deep Dome	25/cs.
62200047	<i>C916</i>	16" dia., Combo, 25 ct., Black	25/cs.
62209516	<i>C9516</i>	16" dia., Combo, Deep Dome	25/cs.
62200921	<i>9518</i>	18" dia.	36/cs.
62209518	<i>C9518</i>	18" dia., Combo, Deep Dome	25/cs.



I. STURDIWARE® TRAY COMBO PACKS SABERT

Sturdy and good-looking, these rigid plastic platters are ideal when extra strength is required for heavier presentations.

62209016	<i>C9016</i>	16" dia., Black, Includes Lid	25/cs.
62209018	<i>C9018</i>	18" dia., Black, Includes Lid	25/cs.



Caterware/Bakery Boxes



A. LOW DOME LIDS

SABERT

Dome lids for platters.

62205014	5212	12" dia. x 2 1/2", Clear	36/cs.
62205512	5512	12" dia. x 3 1/2", Clear	36/cs.
62205516	5516	16" dia. x 4", Clear	36/cs.
62205518	5518	18" dia. x 4", Clear	36/cs.



B. FRESHPACK® BOWL COMBO PACK/LID

SABERT

Stackable serving bowls manufactured from PETE and complemented with leak resistant flat and dome lids.

62203100	C93096A50	96 oz., Round w/Lid, Black/Clear	50/cs.
62200490	51160A50	Lid Fits 160 oz. Bowl, 12" dia., Clear	50/cs.



C. CATERLINE® CASUALS™ ROUND TRAY COMBOS

WNA COMET

Platter with dome.

12202812	ACP512BL	12", Black/Clear	25/cs.
12202813	ACP516BL	16", Black/Clear	25/cs.
12202814	ACP518BL	18", Black/Clear	25/cs.



D. CATERLINE® RECTANGLE TRAY/LID

WNA COMET

Caterline® offers distinction, strength, and value to any catered event.

12202741	A1410BL	14" x 10", Black, Use A1410DM Lid	25/cs.
12202745	A1410DM	Dome Lid Fits 14" x 10" x 2"D, Clear	50/cs.



E. CATERLINE® DOME LID

WNA COMET

Leak-resistant PET dome lid. Exclusive "Press-n-Lift" tab makes opening and re-closing a snap without dome damage.

12202785	APB160DM	Fits APB160 Bowl, 12" x 1 1/2", Clear	25/cs.
----------	----------	---------------------------------------	--------



BAKERY BOXES

F. DONUT BOXES

PRIME SOURCE®

Time saver window. Solid bleached sulfate board carton. Printed "Our Bakery".

77000017	77000017	10 1/4" x 8" x 4", Dozen	125/cs.
77000018	77000018	18 1/2" x 4" x 3 1/2", Dozen	125/cs.



G. BAKERS' CRAFT™ BOXES

CLIMAX MFG

Manufactured from 100% recycled fiber, 30% post-consumer waste.

Cake

25234116	BX411615	10" x 10" x 5"	100/cs.
25234117	BX411616	14" x 10" x 4", 1/4 Sheet	100/cs.
25234118	BX441622	19" x 14" x 4", 1/2 Sheet	50/cs.
25234115	BX451623	26" x 18" x 3", Full Sheet	25/cs.

Donut

25234114	BX411634	9" x 4 1/2" x 4", 1/2 Dozen	100/cs.
25234113	BX411636	10 1/4" x 8" x 4", 1 Dozen	100/cs.

Pie

25234111	BX411611	8" x 8" x 2 1/2"	100/cs.
25234112	BX493370	10" x 10" x 2 1/2"	100/cs.



CONTAINERS & TRAYS

Bakery Boxes/Plastic Cake Containers



A - B



A. AUTO BAKERY BOX W/WINDOW

HONEYMOON PAPER PRODUCTS

Show off baked goods and keep them fresher longer with automatic window cake boxes that quickly erect.

38471083 SW19144W 19" x 14" x 4", 1/2 Sheet 50/cs.

B. WINDOW BOX

HONEYMOON PAPER PRODUCTS

Window boxes are perfect for displaying fresh baked items. Great for supermarkets and those with limited space or movement.

38471082 SW1264W 26" x 18" x 3", Full Sheet 25/cs.

C. NON-WINDOW BAKERY BOXES

SOUTHERN CHAMPION TRAY

White, lock corner, one piece, tuck top, CCK, poly wrapped. Recyclable and compostable where facilities exist.

18406520 0941 8" x 8" x 4" 250/cs.

18407000 0949 9" x 5" x 4" 250/cs.

18406525 0961 9" x 9" x 4" 200/cs.

18407010 0977 10" x 10" x 5 1/2" 100/cs.

18409890 0989 12" x 12" x 6" 50/cs.

18407300 1025 14" x 10" x 4", 1/4 Sheet 100/cs.

Bright white, grease proof, lock corner, one piece, bottom, corrugated, poly wrapped.

18401190 1190 Bottom Fits #1040 Top, 25 7/8" x 18 1/8" x 4", Full Size 25/cs.



PLASTIC CAKE CONTAINERS



D. BAKE 'N SHOW CAKE TRAYS/LID

GENPAK

Made of environmentally friendly CPET material. Can use in conventional and convection ovens to 450°F. Also microwaveable. Fill and freeze with batter for baking later. Stack and ship rigid design.

34780066 55388BK 8" x 8", Square, Black 250/cs.

34780036 95388 Lid Fits 8" x 8" 250/cs.

34785508 55A08BK 8 1/2" x 3 1/8", Angel Food, Black 200/cs.

E



E. CLEAR LID

GENPAK

Clear lid fits shallow and regular 8" angel food and 8" round cake trays.

34789508 95A08 Clear 200/cs.

F



F. TWO PIECE CAKE SETS

INLINE PLASTICS

Two piece cake set.

39351005 1007SBK 7" Cake, Single Layer 100/cs.

39351006 1008BK 8" Cake, Double Layer 100/cs.

39351004 1008SBK 8" Cake, Single Layer 100/cs.

39351009 1009BK 9" Cake, Double Layer 50/cs.

G



G. FLUTED APET CAKE PACKAGING

PACTIV

APET cake combo pack. Black base.

16207660 YHRB500F For 8" Half Round Cake, 5" Fluted Dome 60/cs.

16203485 YHSB500F1TAB 1/2 Sheet, 5" Fluted Dome w/Tab 35/cs.

Plastic Cake Containers



A. ROSEDOME™ APET CAKE PACKAGING PACTIV

Cake combo packs. Black bases.

Rectangular

16202626	BCB425R	4 1/4" Bar Cake, 5"H	100/cs.
16203481	YESB425LRTAB	1/8 Sheet, 4 1/4"H w/Label Panel	50/cs.
16202338	YESB500R	1/8 Sheet, Shallow Dome	50/cs.
16203473	YESB500RTAB	1/8 Sheet, 5"H	50/cs.
16202839	YQSB425R	1/4 Sheet, 4 1/4"H	50/cs.
16203027	QSB600LR	1/4 Sheet, 6"H w/Label Panel	60/cs.
16205971	HSB500R	1/2 Sheet, 5"H	25/cs.
16203424	YHSB500R1TAB	1/2 Sheet, 5"H	30/cs.

Round

16202654	CB1025BR350R	For 8"-9" Cake, 10 1/4" Base, 3 1/2"H	100/cs.
16202659	CB1025BR525R	For 8"-9" Cake, 10 1/4" Base, 5 1/4"H	110/cs.
16202731	CB11BR350R	For 9" Cake, 3 1/2"H	80/cs.
16202733	CB11BR525R	For 9" Cake, 5 1/4"H	40/cs.
16205954	CB13B350R	For 10"-11" Cake, 3 1/2"H	50/cs.
16205951	CB13B575R	For 10"-11" Cake, 5 1/4"H	50/cs.



B. SWIRL APET SHEET CAKE PACKAGING PACTIV

1/4 sheet cake combo pack. Black base.

16203475	YQSB500RSTAB	Black Base w/5" Swirl Dome	65/cs.
----------	--------------	----------------------------	--------

C. SHOWCAKE® CAKE PACKAGING PACTIV

Clear dome, black base. Provide strong, crystal clear packaging. The sturdy ribbed construction protects bakery items and enhances appearance.

16202077	EH89702	7" Cake, 1-2 Layers	100/cs.
16202204	EH89701	7" Cake, 2-3 Layers	100/cs.
16201988	EH89851	8" Half Cake, 2-3 Layers	100/cs.
16201848	EH89802	8" Cake, 1-2 Layers	100/cs.
16201847	EH89801	8" Cake, 2-3 Layers	100/cs.
16202317	EH89902	9" Cake, 1-2 Layers	90/cs.
16202309	EH89901	9" Cake, 2-3 Layers	100/cs.



D. SMARTLOCK® SHOWCAKE® CAKE COMBOS PACTIV

Tight seal plastic bases and domes with Loc Tight™ closure that prevents opening of the packages while on display or during transport. Includes foam cake board.

16201854	9518SKZ	11" x 9" x 3 1/2", 1/8 Sheet, Clear/Clear	110/cs.
16201857	9519SK	11 3/16" x 6 9/16" x 4 1/2", Bar Cake, Clear/Clear	100/cs.
16203047	9714SKHK	14" x 10" x 4 1/2", 1/4 Sheet, Deep, Black/Clear	50/cs.

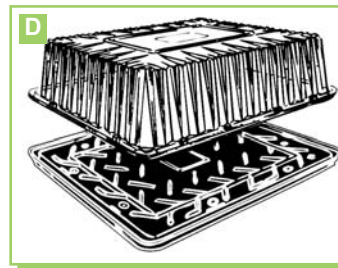

E. ULTRA PAC™ CAKE/CUPCAKE COMBO PACTIV

Holds one dozen cupcakes and one 8" cake.

16203253	12438	16" dia. x 3 1/2", Black/Clear	25/cs.
----------	-------	--------------------------------	--------



F. FLUTED CAKE COMBOS PACTIV-PWP

Showcases your products. Outstanding clarity for optimum product visibility. Black base with clear dome.

Rectangular

64930372	12SBT245S	12" x 4 1/2", PET	50/cs.
64930390	12SBT260S	12" x 6", PET	45/cs.
64930375	PQS375	1/4 Sheet, 14 1/2" x 10 3/4" x 3 3/4"	50/cs.
64930476	PQS475	1/4 Sheet, 14 1/2" x 10 3/4" x 4 3/4"	50/cs.
64930046	PHS50	1/2 Sheet, 20" x 15" x 5"	25/cs.

Round

64930130	09B325	For 7" Cake, 3 1/4"H	100/cs.
64931150	11B50	For 9" Cake, 5"H	50/cs.
64931314	13B525	For 11" Cake, 5 1/4"H	50/cs.



Plastic Cake & Pie Containers



A. SWIRL CAKE COMBOS			PACTIV-PWP
Swirl dome with black base.			
64930740	07B40S	For 5" Cake, 6 ⁷ / ₈ " x 4"	150/cs.
64930041	09B40S	For 7" Cake, 9" x 4"	100/cs.
64930171	09B525S	For 7" Cake, 9" x 5 ¹ / ₄ "	100/cs.
64930163	10B35SG	For 8" Cake, 9 ³ / ₄ " x 3 ¹ / ₂ "H, Grocery Application	100/cs.
64930256	10B525S	For 8" Cake, 9 ³ / ₄ " x 5 ¹ / ₄ "	100/cs.



B. CAKE BASE			PACTIV-PWP
Base for 10" cake.			
64930190	12B	12 ¹ / ₄ ", Black	100/cs.

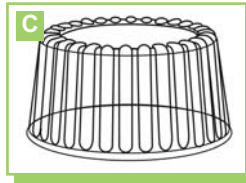

C. DOME			PACTIV-PWP
Fluted dome lid.			
64930803	09325	For 7" Cake, 3 ¹ / ₄ "H	200/cs.



D. BAKEABLES™ ANGEL FOOD CAKE PANS			PACTIV REYNOLDS
Ovenable and microwaveable angel food cake pans and after bake lids.			
18900212	13297	48 oz., 8" dia. x 3"H, Natural	280/cs.
18900211	13300	82 oz., 9" dia. x 4"H, Black	200/cs.



E. ULTRA FRESH™ CLAMSHELL			PACTIV REYNOLDS
Cake/pie slice clamshell.			
18900809	10803	3", Clear	250/cs.



F. LAVA CAKE PACKAGING			SABERT
Lava cake packaging.			
62200183	961106U	Tray	100/cs.
62200184	581106U	Lid	100/cs.



G. SURE LOCK® HINGED CONTAINERS			INLINE PLASTICS
Sure Lock® keeps container closed until customer opens it. Lid will not open unexpectedly for maximum closure security during transit or while handling. Crystal clear material.			
Relaxed hinge design.			
39352313	SL108	6" Pie, Shallow	200/cs.
39352312	SL106	6" Pie, Clear	300/cs.
39350991	SLP218	8" Pie (Tall)	150/cs.
39350913	SL118	8" Pie Deep	200/cs.
39350924	SL109	9" Pie	200/cs.
39350980	SLP120	9" Pie Deep	200/cs.
39350925	SL110	10" Pie	200/cs.



H. PIE CONTAINER			PACTIV
One-piece hinged pie container.			
16209019	C189019	9 oz., 9", Deep, Clear	500/cs.



I. PIE CONTAINER			PACTIV
Two-piece, clear top and black bottom provides an excellent presentation.			
16201986	EH89030	26 ¹ / ₂ oz., 8" w/Shallow Dome, Black/Clear	160/cs.

Plastic Pie, Cookie & Muffin/Cupcake Containers



A. SHOWPIE® PIE PACKAGE PACTIV

Clear one-piece hingeware provides an excellent presentation for pies.

16200005 9710S 11" x 2¹/₈", Shallow 100/cs.



B. PIE COMBO PACTIV-PWP

Swirl dome with black base.

64930217 10P275SG 9³/₄" x 2³/₄", For 9" Pie 100/cs.

C. PIE COMBO PACTIV-PWP

Fluted dome with black base.

64930236 10P175 9³/₄" x 1³/₄", For 9" Pie 100/cs.



PLASTIC COOKIE CONTAINERS

D. BAKE 'N SHOW PIZZA/COOKIE TRAY GENPAK

Our Bake 'n Show line of products make it easy to bake and sell. Our plastic bakery trays and pans have the ability to go from the oven...all the way home! Their strength makes them perfect for automated processes, and since the pans and trays won't warp or dent, they'll protect your product better too. Made of environmentally friendly CPET material. Can use in conventional and convection ovens to 450°F. Also microwaveable. Fill and freeze with batter for baking later. Stack and ship rigid design.

34780014 55C12 12³/₄" x 1", Black 100/cs.

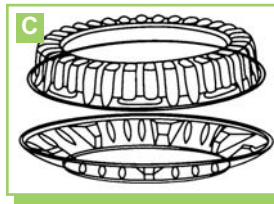

E. CLEARVIEW™ SMARTLOCK® COOKIE CONTAINER PACTIV

ClearView™ SmartLock® bakery containers provide excellent strength, clarity and an audible locking feature.

16201595 C181224 8¹³/₃₄" x 8¹¹/₃₂" x 2⁵/₁₆", Dozen, Clear 200/cs.

F. COOKIE TRAY PACTIV-PWP

9" rectangle 24 cell cookie tray with clear flat lid.

64930242 09R4024CCCLID 9²/₅" x 8¹/₉" x 4", Clear 72/cs.

G. COOKIE CONTAINER PAR-PAK

12 count cookie container. Clear PETE hinged lid container.

16502691 82691 8¹/₈" x 7⁵/₈" x 3¹/₈" 250/cs.

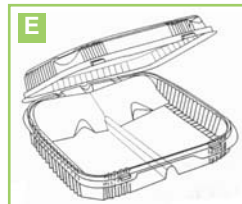
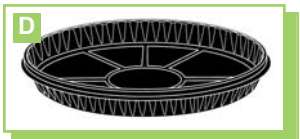

PLASTIC MUFFIN/CUPCAKE CONTAINERS

H. SURE LOCK® HINGED CUPCAKE CONTAINERS INLINE PLASTICS

Sure Lock® keeps container closed until customer opens it. Lid will not open unexpectedly for maximum closure security during transit or while handling. Crystal clear material.

Relaxed hinge design.

39350967 SLP52 (2) Cupcakes, 8⁷/₈" x 5⁵/₁₆" x 3³/₈" 500/cs.

39350954 SLP44A (4) Cupcakes, 6¹¹/₁₆" x 6¹¹/₁₆" x 3⁵/₁₆" 288/cs.

39350946 SLP45 (4) 5 oz. Muffins, 7⁵/₈" x 8¹/₁₆" x 3¹/₄" 300/cs.

39350939 SLP54 (4) Large Muffins, 7⁵/₈" x 8¹/₁₆" x 3¹/₄" 300/cs.

39350117 SLP54SP (4) Large Muffins, 7⁵/₈" x 8¹/₁₆" x 3¹/₄" 300/cs.

39350921 SLP74 (4) Large/Texas Muffins (5¹/₂ oz.), 8¹/₄" x 8³/₄" x 3¹/₈" 300/cs.

39350906 SLP46 (6) Muffins, 9³/₈" x 6³/₄" x 2⁷/₈" 300/cs.

39350907 SLP56 (6) Muffins/Decorated Cupcakes, 9⁹/₁₆" x 6¹⁵/₁₆" x 4" 300/cs.

39350955 SLP34 (12) Mini Muffins, 8¹¹/₁₆" x 7¹/₈" x 2¹/₄" 250/cs.

39352305 SLP017 (12) Mini Muffins, 8¹³/₁₆" x 7³/₁₆" x 1⁷/₈" 250/cs.

39350922 SLP212 (12) Decorated Cupcakes, 12¹⁵/₁₆" x 10¹/₄" x 3³/₈" 100/cs.



Plastic Muffin/Cupcake Containers



CONTAINERS & TRAYS

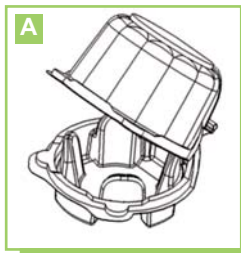

A. SINGLE-SERVE CUPCAKE CONTAINER LINDAR CORPORATION

One-piece solution for single cupcakes and muffins. Enhanced display and protection. Multiple label locations. Stacks and opens effortlessly. Made from PET.

29380001 81170111 4" x 4³/₈" x 3¹/₈", Traditional 100/cs.

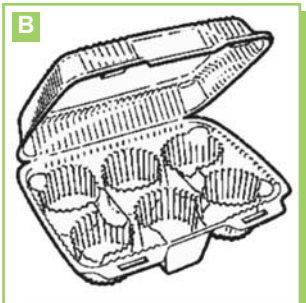

B. CLEARVIEW™ SMARTLOCK® CUPCAKE/MUFFIN CONTAINERS PACTIV

ClearView™ SmartLock® bakery containers provide excellent strength, clarity and an audible locking feature.

16201837 C189060 6 ct., 9³/₄" x 6⁷/₈" x 3", Shallow, Clear 220/cs.
16202068 C189360 6 ct., 9³/₄" x 6⁷/₈" x 3³/₄", Deep, Clear 250/cs.



C. CUPCAKE COMBO PACTIV

Plastic cupcake combo.

16201028 CB675B625R 6³/₄", Black/Clear, 6¹/₂" Rosedome Lid 160/cs.



D. CUPCAKE CONTAINERS PACTIV-PWP

Plastic cupcake containers.

64930344 OCASH107356C 6 ct. 125/cs.
64933513 OCASH1310351 12 ct. 150/cs.
64930374 24TIERCC18B4 24 ct. 30/cs.



E. HINGED BAKERY CONTAINER PACTIV-PWP

Swirl bakery container with label panel.

64930312 16X7H3510CSL 10 ct., 5³/₄" x 7⁵/₁₆" x 4", Clear 160/cs.

Barrel Sacks/Grocery Bags



BARREL SACKS/GROCERY BAGS

A. GROCERY BAGS

AJM PACKAGING

Grocery bags.

10100574	GB04NP5C	4 lb., 5" x 3 ¹ / ₈ " x 9 ³ / ₄ ", Kraft	500/cs.
10100219	WB04NP5C	4 lb., 5" x 3 ¹ / ₈ " x 9 ³ / ₄ ", White, 30#	500/cs.
10100573	GB06NP5C	6 lb., 11 ¹ / ₂ " x 10 ¹ / ₂ " x 6 ¹ / ₄ ", Kraft	500/cs.
10100572	GB08NP5C	8 lb., 6 ⁵ / ₈ " x 4" x 12 ³ / ₈ ", Kraft	500/cs.
101000305	GB10NP5C	10 lb., 6 ⁵ / ₈ " x 4 ³ / ₁₆ " x 13 ³ / ₈ ", 35#, Kraft	500/cs.
10100064	WB16NP5C	16 lb., 7 ³ / ₄ " x 4 ¹³ / ₁₆ " x 16", White	500/cs.
101000355	GB16NP5C	16 lb., 16" x 8" x 12", 40#, Kraft	500/cs.
10100063	WB20NP5C	20 lb. Squat, 15" x 7 ⁷ / ₈ " x 17", White	500/cs.



B. BARREL SACKS

DURO BAG

Strong paper barrel sacks. Put your confidence in the strength of Duro sacks.

13203011	81186	1/8 Tall, 9 ³ / ₄ " x 6 ¹ / ₄ " x 16 ³ / ₈ ", 52#, Kraft	500/bdl.
13201225	81187	1/8 Tall, 9 ³ / ₄ " x 6 ¹ / ₄ " x 16 ³ / ₈ ", 57#, Kraft	500/bdl.
13200049	80082	1/8 Short, 10 ¹ / ₈ " x 6 ³ / ₄ " x 14 ³ / ₈ ", 52#, Kraft	500/bdl.
13200051	80083	1/8 Short, 10 ¹ / ₈ " x 6 ³ / ₄ " x 14 ³ / ₈ ", 57#	18/cs.
132000515	80083	1/8 Short, 10 ¹ / ₈ " x 6 ³ / ₄ " x 14 ³ / ₈ ", 57#	500/bdl.
13200058	80091	1/6, 12" x 7" x 17", 40/40# Duplex, Kraft	400/bdl.
13200053	80075	1/6, 12" x 7" x 17", 52#, Kraft	500/bdl.
13200059	80076	1/6, 12" x 7" x 17", 57#, Kraft	500/cs.
13200055	80078	1/6, 12" x 7" x 17", 66#, Kraft	500/cs.
13200056	80080	1/6, 12" x 7" x 17", 76#, Kraft	400/bdl.
13201211	80071	1/4 Tuff, 12" x 7" x 21 ³ / ₄ ", 66#, Kraft	250/bdl.



C. BULWARK EXTRA HEAVY-DUTY GROCERY BAGS

DURO BAG

Extra heavy-duty kraft grocery bags. Tough, strong and sturdy. Made to hold those weighty, awkward items, like bottles, cans and objects where a regular grocery bag just won't do. You can count on the extra strength these bags get from their 50-57 lb. basis weight, up from the 30-40 lb. basis weight of regular bags. You won't have to worry about tearing, ripping or stretching. Designed to stand up stoutly, no falling over or spilling. No need to double bag.

13208114	81014	12 lb., 7 ¹ / ₁₆ " x 4 ¹ / ₂ " x 13 ³ / ₄ ", 57#, Kraft	500/bdl.
13209004	80044	16 lb., 7 ³ / ₄ " x 4 ¹³ / ₁₆ " x 16", 57#, Kraft	500/bdl.
13209129	80046	20 lb. Shorty, 8 ¹ / ₄ " x 5 ¹⁵ / ₁₆ " x 13 ³ / ₈ ", 57#, Kraft	500/bdl.
13200062	80048	25 lb. Shorty, 8 ¹ / ₄ " x 6 ¹ / ₈ " x 15 ⁷ / ₈ ", 57#, Kraft	500/bdl.



D. HUSKY HEAVY-DUTY BAGS

DURO BAG

Give your products an extra dose of protection. The 50 lb. basis weight ensures a strong bag that will transport heavier items without worry of an accident. Thicker than a regular grocery bag, but not quite the armor of our Bulwark bag, this bag fits all the needs in between.

Available both plain and custom printed, so you can get exactly the bag you want.

13201159	81158	12 lb. Shorty, 7 ¹ / ₁₆ " x 4 ¹ / ₂ " x 13 ³ / ₄ ", 50#, Kraft	500/bdl.
13208621	80066	20 lb. Shorty, 8 ¹ / ₄ " x 5 ¹⁵ / ₁₆ " x 14 ³ / ₈ ", 50#, Kraft	500/bdl.
13201111	80068	25 lb. Shorty, 8 ³ / ₈ " x 6 ¹ / ₈ " x 15 ¹ / ₄ ", 50#, Kraft	500/bdl.



Grocery & Liquor Bags

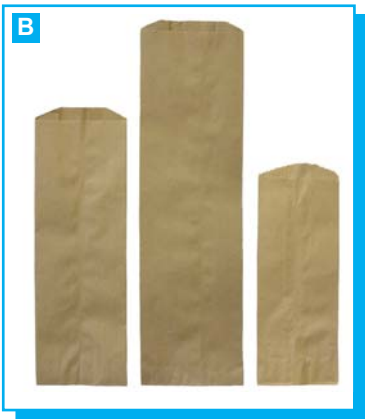

BAGS

A. GROCERY BAGS

DURO BAG

Paper grocery bags. The ideal environmentally-conscience choice for a variety of retail and grocery stores for consumers to carry purchases home.

Kraft

13200010	80001	1/2 lb., 3" x 1 ⁷ / ₈ " x 5 ⁷ / ₈ ", 30#	10000/bdl.
13200012	80003	1 lb., 3 ¹ / ₂ " x 2 ³ / ₈ " x 6 ⁷ / ₈ ", 30#	8000/bdl.
13200340	81006	2 lb., 4 ⁵ / ₁₆ " x 2 ⁷ / ₁₆ " x 7 ⁷ / ₈ ", 30#	500/bdl.
13200014	80005	2 lb., 4 ⁵ / ₁₆ " x 2 ⁷ / ₁₆ " x 7 ⁷ / ₈ ", 30#	6000/bdl.
13200101	80006	3 lb., 4 ³ / ₄ " x 2 ¹⁵ / ₁₆ " x 8 ⁹ / ₁₆ ", 30#	5000/bdl.
13200208	81007	4 lb., 5" x 3 ¹ / ₃ " x 9 ³ / ₄ ", 30#	500/bdl.
13200015	80007	4 lb., 5" x 3 ¹ / ₃ " x 9 ³ / ₄ ", 30#	4000/bdl.
13200016	80009	5 lb., 5 ¹ / ₄ " x 3 ⁷ / ₁₆ " x 10 ¹⁵ / ₁₆ ", 35#	3000/bdl.
13200204	80983	6 lb., 6" x 3 ⁵ / ₈ " x 11 ¹ / ₁₆ ", 35#	500/bdl.
13200017	80010	6 lb., 6" x 3 ⁵ / ₈ " x 11 ¹ / ₁₆ ", 35#	2000/bdl.
13200206	80984	8 lb., 6 ¹ / ₈ " x 4 ¹ / ₈ " x 12 ⁷ / ₁₆ ", 35#	500/bdl.
13200018	80957	8 lb., 6 ¹ / ₈ " x 4 ¹ / ₈ " x 12 ⁷ / ₁₆ ", 35#	2000/bdl.
13200985	80985	10 lb., 6 ⁵ / ₁₆ " x 4 ³ / ₁₆ " x 13 ³ / ₈ ", 35#	500/bdl.
13200019	80958	10 lb., 6 ⁵ / ₁₆ " x 4 ³ / ₁₆ " x 13 ³ / ₈ ", 35#	2000/bdl.
13200023	80959	12 lb., 7 ¹ / ₁₆ " x 4 ¹ / ₂ " x 13 ³ / ₄ ", 40#	1000/bdl.
13200982	80982	12 lb., 7 ¹ / ₁₆ " x 4 ¹ / ₂ " x 13 ³ / ₄ ", 40#	500/bdl.
13200024	80960	16 lb., 7 ³ / ₄ " x 4 ¹³ / ₁₆ " x 16", 40#	1000/bdl.
13200178	80976	16 lb., 7 ³ / ₄ " x 4 ¹³ / ₁₆ " x 16", 40#	500/bdl.
13200026	80962	20 lb. Shorty, 8 ¹ / ₄ " x 5 ¹⁵ / ₁₆ " x 13 ³ / ₈ ", 40#	1000/bdl.
13200979	80979	20 lb. Shorty, 8 ¹ / ₄ " x 5 ¹⁵ / ₁₆ " x 13 ³ / ₈ ", 40#	500/bdl.
13200177	80961	20 lb., 8 ¹ / ₄ " x 5 ⁵ / ₁₆ " x 16 ¹ / ₈ ", 40#	500/cs.
13200025	80961	20 lb., 8 ¹ / ₄ " x 5 ⁵ / ₁₆ " x 16 ¹ / ₈ ", 40#	1000/bdl.
13200980	80980	25 lb. Shorty, 8 ¹ / ₄ " x 6 ¹ / ₈ " x 15 ⁷ / ₈ ", 40#	500/bdl.
13200034	80964	25 lb. Shorty, 8 ¹ / ₄ " x 6 ¹ / ₈ " x 15 ⁷ / ₈ ", 40#	1000/bdl.
13200978	80978	25 lb., 8 ¹ / ₄ " x 5 ¹ / ₄ " x 18", 40#	500/cs.
13200027	80963	25 lb., 8 ¹ / ₄ " x 5 ¹ / ₄ " x 18", 40#	1000/bdl.

White

13201232	81232	2 lb., 4 ⁵ / ₁₆ " x 2 ⁷ / ₁₆ " x 7 ⁷ / ₈ ", 30#	500/bdl.
13200032	80023	2 lb., 4 ⁵ / ₁₆ " x 2 ⁷ / ₁₆ " x 7 ⁷ / ₈ ", 30#	6000/bdl.
13202100	80024	3 lb., 4 ³ / ₄ " x 2 ¹⁵ / ₁₆ " x 8 ⁹ / ₁₆ ", 30#	5000/bdl.
13200213	81250	4 lb., 5" x 3 ¹ / ₃ " x 9 ³ / ₄ ", 30#	500/bdl.
13200035	80025	4 lb., 5" x 3 ¹ / ₃ " x 9 ³ / ₄ ", 30#	4000/bdl.
13200205	80026	5 lb., 5 ¹ / ₄ " x 3 ⁷ / ₁₆ " x 10 ¹⁵ / ₁₆ ", 35#	3000/bdl.
13200211	81223	6 lb., 6" x 3 ⁵ / ₈ " x 11 ¹ / ₁₆ ", 35#	500/bdl.
13200036	80027	6 lb., 6" x 3 ⁵ / ₈ " x 11 ¹ / ₁₆ ", 35#	2000/bdl.
13200215	81273	8 lb., 6 ¹ / ₈ " x 4 ¹ / ₈ " x 12 ⁷ / ₁₆ ", 35#	500/bdl.
13200037	80965	8 lb., 6 ¹ / ₈ " x 4 ¹ / ₈ " x 12 ⁷ / ₁₆ ", 35#	2000/bdl.
13200038	80966	10 lb., 6 ⁵ / ₁₆ " x 4 ³ / ₁₆ " x 13 ³ / ₈ ", 35#	2000/bdl.
13200209	81004	12 lb., 7 ¹ / ₁₆ " x 4 ¹ / ₂ " x 13 ³ / ₄ ", 40#	500/bdl.
13200039	80967	12 lb., 7 ¹ / ₁₆ " x 4 ¹ / ₂ " x 13 ³ / ₄ ", 40#	1000/bdl.
13200040	80968	16 lb., 7 ³ / ₄ " x 4 ¹³ / ₁₆ " x 16", 40#	1000/bdl.
13200326	81012	20 lb., 8 ¹ / ₄ " x 5 ⁵ / ₁₆ " x 16 ¹ / ₈ ", 40#	500/cs.
13200041	80969	20 lb., 8 ¹ / ₄ " x 5 ⁵ / ₁₆ " x 16 ¹ / ₈ ", 40#	1000/bdl.
13200970	80970	25 lb. Shorty, 8 ¹ / ₄ " x 6 ¹ / ₈ " x 15 ⁷ / ₈ ", 40#	1000/bdl.

LIQUOR BAGS

B. LIQUOR BAGS

AJM PACKAGING

Kraft liquor bags.

10101902	LP35NP5C	12 ³ / ₄ " x 4" x 7 ¹ / ₄ ", Pint	500/cs.
10100401	LQ35NP5C	17" x 4 ¹ / ₂ " x 8 ¹ / ₄ ", Quart	500/cs.

C. LIQUOR BAGS

DURO BAG

Paper bags. Duro Bags fit any size party.

13202514	82514	3 ³ / ₄ " x 2 ¹ / ₄ " x 11 ¹ / ₂ ", 1 Pint, 35#, Liquor, Kraft	500/cs.
13201056	81056	3 ³ / ₄ " x 2 ¹ / ₄ " x 11 ¹ / ₂ ", 1 Pint, Liquor, Kraft	4000/bdl.
13201527	81527	4 ¹ / ₂ " x 2 ¹ / ₂ " x 16", 1 qt., 35#, Liquor, Kraft	500/bdl.
13200000	80218	4 ¹ / ₂ " x 2 ¹ / ₂ " x 16", 1 qt., Liquor, Kraft	2000/bdl.
13200295	8165	8 ¹ / ₄ " x 6 ¹ / ₈ " x 15 ⁷ / ₈ ", 25 lb. Shorty, 65#, Beer, Kraft	500/bdl.

Handle/Merchandise Bags

HANDLE/MERCHANDISE BAGS

A. PRIME SOURCE® SHOPPING BAGS

PRIME SOURCE®

Eco-friendly reusable fabric shopping bag. This attractive, long-lasting, non-woven shopping bag folds into a compact 7" x 6 1/2" pack, making it easy to carry when you shop. Perfect for customer shopping needs.

76008624	76008624	13 1/2" x 16 1/2" x 15", Black	100/bdl.
76008620	76008620	13 1/2" x 16 1/2" x 15", Green	100/bdl.
76008622	76008622	13 1/2" x 16 1/2" x 15", Navy	100/bdl.
76008621	76008621	13 1/2" x 16 1/2" x 15", Red	100/bdl.
76008623	76008623	13 1/2" x 16 1/2" x 15", Yellow	100/bdl.

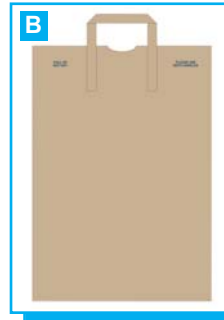

B. GROCERY SACKS

AJM PACKAGING

Kraft handled sacks.

10106502	SS52NP5C	6 1/2" x 10 1/2" x 14 1/2", 1/8 BBL, 52#, Kraft	500/cs.
10100575	GS57NP5C	12" x 7" x 17", 1/6 BBL, 57#, Kraft	500/bdl.
10100577	GS65NP5C	12" x 7" x 17", 1/6 BBL, 65#, Kraft	500/cs.

C. DIE CUT HANDLE BAGS

DURO BAG

Bag with a large rectangular flat bottom perfect for take-out. Available plain or custom printed with up to four colors.

13204245	84245	11" x 6" x 11", 1/8, 40#, Kraft	500/cs.
----------	-------	---------------------------------	---------



D. HANDLE BAGS

DURO BAG

It's no wonder consumers prefer the original "handle-up" handle bag by Duro four-to-one over other packaging alternatives. The idea is so unique that it's patented. With wide, stand-up handles and longer adhesive attaching strips, our handle-up bag is stronger, more durable, and more comfortable to use. And with superior custom printing in up to three colors on four sides, your message will really stand out. Handle bags are offered in kraft and white paper in a variety of sizes, and a handle-down style is also available.

13208888	88885	12" x 7" x 17", 1/6, 70#, Kraft, Thank You	300/bdl.
----------	-------	--	----------



E. MERCHANDISE BAGS

DURO BAG

With its pinch-bottom design, Duro's merchandise bags can be found in retail and specialty stores everywhere, from pharmacies to gift shops to boutiques. Available in a variety of paper types and sizes. Can be printed in up to four colors on all sides.

13200001	80201	6 1/4" x 9 1/4", 30#, Kraft	6000/bdl.
13204852	14852	8 1/2" x 11", 30#, Kraft	2000/cs.
13200002	80221	8 1/2" x 11", 30#, Kraft	4000/bdl.
13200233	80233	10" x 13", 30#, Kraft	2000/bdl.
13200004	80279	12" x 3" x 18", 30#, Kraft	1000/bdl.
13204871	14871	12" x 15", 30#, Kraft	1000/cs.
13201101	80243	12" x 15", 30#, Kraft	2000/bdl.
13200048	80293	14" x 3" x 21", 30#, Kraft	1000/bdl.
13200273	80273	15" x 18", 30#, Kraft	1000/bdl.
13200006	80304	17" x 4" x 24", 30#, Kraft	500/bdl.



F. SHOPPING BAGS

DURO BAG

Whatever you're selling, food, clothing, shoes, hardware, novelties, or you-name-it, Duro has the bag to meet all of your packaging needs. We offer a tremendous variety of styles, papers, handles and coatings, and our bags come in a wide array of sizes. To complete the look we offer sophisticated custom print options, including: six-color printing, offset printing, hot stamping, and gravure. Additional options include tissue inserts, hang tags, and bag labels. With all of Duro's options, you can build the perfect shopping bag, one that does more than carry your products; it advertises them.

13208459	84597	8" x 4 3/4" x 10 1/4", 60#, Kraft, Tempo	250/cs.
13204614	84614	10" x 5" x 13", Kraft, Missy	250/cs.
13201103	11001	10" x 6 3/4" x 12", 60#, Bistro	250/cs.
13205925	85925	14" x 10" x 15 1/2", 70#, Kraft, Super Royal	200/bdl.
13200438	85934	14" x 10" x 15 1/2", 70#, White, Super Royal	200/bdl.
13206779	86779	16" x 6" x 12", 65#, Kraft, Tote	250/cs.



Handle/Merchandise & T-Shirt/Tote Bags



A. STOCK THANK YOU BAGS

DURO BAG

Duro's Stock Thank You Bag with the patented Handle-Up design are a customer favorite. Merchants appreciate the sturdy construction and self-standing feature that make packing easier. Customers appreciate the ease in carrying the bag with its patented handle. The roomy size and strong handles ensure that merchandise will arrive safely at its destination. After toting those boxes of cereal, facial tissues or spaghetti home from the store, this bag will hold up for additional uses like bringing a casserole to the church pot luck, taking hand-me-downs to the neighbor, or carrying compost to the garden. The bag can be used again and again.

13204132 41265 12" x 7" x 17", 1/6, 70#, Kraft, Thank You 300/cs.

T-SHIRT/TOTE BAGS

B. PRIME SOURCE® T-SACKS

HI-VALU

Poly t-sacks.

73000112	73000112	8" x 4 1/4" x 14 1/2", Black Embossed	375/cs.
76000016	76000016	9" x 6 3/4" x 18 1/2", 20 lb., White, High-Density	1000/cs.
73000113	73000113	7 3/4" x 4" x 14 1/2", White Embossed	418/cs.
73000115	73000115	10 1/2" x 6" x 18", Smiley Face, White Embossed	228/cs.
73000114	73000114	11" x 6 1/4" x 17 1/2", Black Embossed	276/cs.
75001312	75001312	11" x 7" x 21", White, Thank You, 11.5 MIC	850/cs.
75001313	75001313	11" x 7" x 21", White/Red, Thank You, 11.5 MIC	900/cs.
75001311	75001311	11" x 7" x 21", White/Red, Thank You, 11.5 MIC	1000/cs.
73000116	73000116	11 1/4" x 6 1/2" x 21 1/2", Black Embossed	175/cs.
73000117	73000117	12" x 7" x 23", Smiley Face, White Embossed	207/cs.



C. PRIME SOURCE® T-SACKS

PRIME SOURCE®

Poly t-sacks.

76000001 76000001 12" x 7" x 23", Smiley Face, 17.5 MIC 500/cs.

D. QUIKMATE EZ® T-SHIRT BAGS

ASSOCIATED PACKAGING TECH

Engineered convenient T-shirt bag style with integrated tabs. Sizes to fit any purchase requirements. Patented easy-open design. Hardware to fit almost any check stand configuration. Dispensing systems, including racks, trays and rolls designed for maximum checkout productivity. "Gray is the New Green."

18302101 4000001 12" x 7" x 22", 1/6, 13 MIC 1000/cs.



E. HIPPO SAK®

CROWN POLY

The invincible grocery bag with the strength of paper and the ease of plastic. Hippo Ties™ prevent bag contents from spilling over in the car. Wider and thicker Hippo Handles are more comfortable to carry. Reinforced bottom seal - Hippo Strip™ eliminates weak stress points. Efficient self-opening feature. Reduces plastic bag usage by 35% or more.

Hippo 8

28168113	T80013	12 1/2" x 7 1/2" x 20 3/5", 13.5 MIC, Natural	1400/cs.
28160051	T89999	12 1/2" x 7 1/2" x 20 3/5", 15.5 MIC, Eco, Green	1300/cs.

Hippo 12

28168013	T38013	12 1/2" x 7 1/2" x 24", 13.5 MIC, Enviro, Natural	1300/cs.
28160373	T30373	12 1/2" x 7 1/2" x 24", 13.5 MIC, Thank You, White	1300/cs.
28168015	T38015	12 1/2" x 7 1/2" x 24", 15.5 MIC, Enviro, Natural	1100/cs.
28168017	T38017	12 1/2" x 7 1/2" x 24", 17.5 MIC, Enviro, Natural	1000/cs.
28169999	T39999	12 1/2" x 7 1/2" x 24", 16.5 MIC, Eco, Green	1050/cs.



F. T-SHIRT BAGS

INTEPLAST CORPORATION

T-shirt bags, sometimes called "carry-out" bags, which are commonly used in grocery and retail stores, have replaced the traditional kraft bag in many applications. Tab-less self-open style. Licensed with patented EZ open feature. Dispensing system designed for checkout efficiency. Standard handle designs to fit store racking hardware systems.

03608625 LSTYFSH1418W 8" x 6 1/4" x 17 1/2" 3000/cs.



T-Shirt/Tote & Unprinted Paper Bags



A. GROCERY BAGS

TRELLIS EARTH®

Forget "paper or plastic"; the clear choice is corn. Communities across the country have been taxing or banning the use of plastic grocery bags. But our grocery bags made from 100% biodegradable ingredients and are just as strong as their plastic counterparts. Toxin free. Semi-translucent and come labeled as biodegradable so your customers will know that you care about our environment.

C4780021	WFB05	8½" x 17¼", Small, 0.7 MIL	1500/cs.
C4780010	WFB04	12" x 21", 15 lb., Bioplastic	1000/cs.

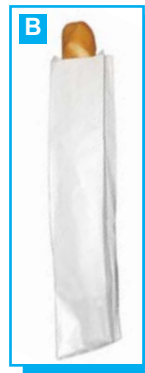

UNPRINTED PAPER BAGS

B. BREAD BAGS

BAGCRAFT/PAPERCON

White paper bread bag with pinch bottom.

10900160	300160	4½" x 2½" x 24"	1000/cs.
10900164	300164	5¼" x 3¼" x 18"	1000/cs.



C. COFFEE BAGS

BAGCRAFT/PAPERCON

Natural kraft auto duplex coffee bags with tin tie. Pasted bottom and polypropylene liner.

10909713	300950	1/2 lb., 3⅜" x 2½" x 7¾"	1000/cs.
-----------------	--------	--------------------------	----------

D. DRY WAX BAGS

BAGCRAFT/PAPERCON

Unprinted dry wax bags. Preserves freshness and provides breathability.

10907904	300440	3½" x 1½" x 8½", Plain, Hot Dog	6000/cs.
10900463	300411	6" x 3¼" x 6½", White, Sandwich	2000/cs.

E. DUBL VIEW® TO GO! DELI BAGS

BAGCRAFT/PAPERCON

Deli bags are fully lined with anti-fog film which provides superior visibility. Improve your fresh and homemade image. Full-view visibility from the side drives impulse sales. Perfect for the cold or hot merchandising case.

10903390	300090	4¼" x 2¾" x 11¾", Natural	500/cs.
-----------------	--------	---------------------------	---------



F. DUBL WAX® CARRYOUT BAGS

BAGCRAFT/PAPERCON

Preserves freshness while still allowing baked foods to breathe. Bright white paper waxed on both sides by special process. SOS automatic bottom style.

10907622	300294	1 lb., Duplex Stand Up Window Bag w/Tin Ties, White	1000/cs.
10907625	300296	6 lb., SOS Bakery Bag, White	1000/cs.
10907628	300298	8 lb., SOS Bakery Bag, White	1000/cs.
10902920	300292	12 lb., SOS Bakery Bag, White	1000/cs.



G. ECOCRAFT® SANDWICH BAGS

BAGCRAFT/PAPERCON

Less mess with grease resistant paper. Hot or cold applications and microwaveable. Easy-to-eat convenience for single portions.

10903003	300100	6½" x 1" x 8", 25#, Natural Kraft	2000/cs.
16400100	300100	6½" x 1" x 8", 25#, Natural Kraft	4000/cs.

H. ECO-PAK STAND-UP WINDOW BAGS

BAGCRAFT/PAPERCON

Stain-resistant duplex construction.

10904300	300249	4¾" x 2½" x 9½"	500/cs.
-----------------	--------	-----------------	---------

I. GREASE RESISTANT BAGS

BAGCRAFT/PAPERCON

Grease resistant bags.

16400019	450003	4½" x 3½", PB3 #3, White, Plain, French Fry	2000/cs.
16400081	450006	4½" x 4½", PB6 #6, White, Plain, French Fry	2000/cs.
16400104	450009	5½" x 4½", PB9 #9, White, Plain, French Fry	2000/cs.
16401019	450019	6" x 3¼" x 7¼", PB19, White	2000/cs.
10900495	300405	6" x 6½", White, Sandwich	2000/cs.



BAGS

Unprinted & Printed Paper Bags



A. SILVERWARE BAGS BAGCRAFT/PAPERCON

Unprinted, white kraft silverware bags.
10900039 300039 2³/₄" x 10" 2000/cs.



B. STAND UP WINDOW BAGS BAGCRAFT/PAPERCON

White kraft auto duplex window bags. Stain resistant paper, polypropylene liner and tin ties.
10900250 300250 1 lb., 4³/₄" x 2¹/₂" x 9¹/₂" 500/cs.



C. WET WAX SANDWICH BAGS BAGCRAFT/PAPERCON

Translucent wet wax sandwich bags.
10900405 300404 6" x 1¹/₁₀" x 7", WX18 1000/cs.



D. OUR DELI® BAKERY BAGS PRIME SOURCE®

Pinch bottom bags.
77003301 77003301 6 lb. 250/cs.
77003303 77003303 12 lb. 250/cs.



E. CLOWN PINCH BOTTOM POPCORN BAGS BAGCRAFT/PAPERCON

Economical and sustainable alternative to cartons and tubs.
10901471 300471 1 lb., 4" x 1¹/₂" x 8" 1000/cs.
10901434 300434 1¹/₄ lb., 3³/₄" x 1³/₄" x 9" 1000/cs.



F. DUBL PANEL® BREAD BAGS BAGCRAFT/PAPERCON

Crispy crusts stay fresh without becoming soggy. Perforated film window for clear visibility. Pinch bottom style. Natural kraft printed with wheat design.
10903883 300883 3¹/₂" x 2" x 26", "Crispy Crust Baguette" Wheat 500/cs.
10900882 300882 6¹/₂" x 3" x 21", "Crispy Crust" Wheat 500/cs.



G. DUBL PANEL® WINDOW BREAD BAGS BAGCRAFT/PAPERCON

Sealing Strip™ closure system for safe sealing with any tape or label. Film window for clear visibility. Pinch bottom design. Waxed natural kraft printed with wheat design.
10900887 300887 8" x 3¹/₂" x 12³/₄", Wheat 500/cs.



H. ECOCRAFT® BREAD BAGS BAGCRAFT/PAPERCON

Allows bread to breathe, ensuring crispy crust. Right-size package reduces cost. Designed for fresh eye-catching appeal. Single matching design to fit all sizes.
Dubl-Panel™ Window
10900908 300893 3¹/₂" x 2" x 26", Artisan Design, Natural Kraft 500/cs.
10900243 300892 6¹/₂" x 3" x 21", Artisan Design, Natural Kraft 500/cs.
10900903 300864 8" x 3¹/₂" x 15", Artisan Design, Natural Kraft 500/cs.
Pinch Bottom
10900904 300868 4¹/₂" x 2¹/₂" x 24", Artisan Design, Natural Kraft 1000/cs.



I. PARMESAN BREAD BITES BAGS BAGCRAFT/PAPERCON

Grease resistant paper bags.
10905684 445684 6³/₅" x 2" x 10", 25# 1000/cs.

BAGS

Printed Paper, Foil & Poly Sandwich Bags



A. TO GO! BAGS BAGCRAFT/PAPERCON

Special moisture and grease resistant white kraft paper. Replace tubs, barns and cartons.

Deli Auto Duplex Bags

Two-ply construction. Venting system releases trapped moisture.

10900566	300566	5 1/2" x 3 1/4" x 8 5/8", Red/Black	500/cs.
10908520	300568	8 1/4" x 5 1/4" x 10 3/4", w/Tin Ties, Red/Black	250/cs.
10900113	300569	8 1/4" x 5 1/4" x 12", w/Tin Ties, Red/Black	250/cs.

Stand Up Single Wall To Go Bags

10900064	300564	8 lb., 6 1/8" x 12 3/8", Red/Black	500/cs.
----------	--------	------------------------------------	---------

Zzip Strip®

10901001	300565	5 lb., 6" x 3 5/8" x 11", Red/Black	500/cs.
----------	--------	-------------------------------------	---------



B. SUBMARINE SANDWICH BAGS BAGCRAFT/PAPERCON

Grease resistant paper provides stain protection. Economical choice for single-serve hot and cold food applications. Convenient package for eating on-the-go.

10900445	300435	4 1/2" x 2" x 14", Stock Design, White	1000/cs.
----------	--------	--	----------



FOIL BAGS

C. ECOCRAFT® GARLIC BREAD BAGS BAGCRAFT/PAPERCON

Lined with unbleached paper. Allows bread to breathe ensuring crispy crust. Right-size package reduces cost. Designed for fresh eye-catching appeal. Single matching design to fit all sizes.

10900909	300861	5 1/4" x 3 1/4" x 20", Artisan Design, Natural Kraft	500/cs.
----------	--------	--	---------



D. FLAME PAK FOIL INSULATOR CARRYOUT BAGS BAGCRAFT/PAPERCON

Foil insulator pinch bottom carryout bag, printed. White kraft paper laminated to foil liner.

Provides heat and moisture protection.

10900481	300481	1 qt., 5 1/4" x 3 1/2" x 12"	1000/cs.
10908516	300502	1/2 gal., 6" x 4 3/4" x 14"	500/cs.

E. FOIL BAGS BAGCRAFT/PAPERCON

Foil and paper lamination improves heat retention.

10900455	300455	3 1/2" x 1 1/2" x 8 1/2", Hot Dog, Printed	1000/cs.
10901013	300456	3 1/2" x 1 1/2" x 8 1/2", Hot Dog, Unprinted	1000/cs.
10901533	533	6" x 3/4" x 6 1/2", Silver, Brushstroke™ Sandwich	1000/cs.
10901529	300529	6" x 3/4" x 6 1/2", #6, Yellow, Cheeseburger	1000/cs.



F. SANDWICH BAGS ZENITH SPECIALTY BAG COMPANY

Plain foil sandwich bags.

75020728	F728	7" x 2" x 8"	1000/cs.
----------	------	--------------	----------



POLY SANDWICH BAGS

G. HI-VALU SADDLE BAGS HI-VALU

HDPE, embossed saddle bags.

73000019	73000019	10 1/4" x 8" +2, 11 MIC	2000/cs.
----------	----------	-------------------------	----------

H. DELI POUCH PRIME SOURCE®

Poly deli bag.

77003101	77003101	8 1/2" x 8", Our Deli	2000/cs.
----------	----------	-----------------------	----------

I. PRIME SOURCE® DELI FRESH BAGS PRIME SOURCE®

Deli bag with Magic-Seal for extra freshness.

75000124	75000124	10 1/2" x 8"	2000/cs.
----------	----------	--------------	----------



BAGS

Poly Sandwich & Bread/Bakery Bags

BAGS



A. PRIME SOURCE® SANDWICH BAGS PRIME SOURCE®

Flip top sandwich bags.

760006005	76000600	6 ³ / ₄ " x 6 ³ / ₄ " x 1"	2000/bx.
76000600	76000600	6 ³ / ₄ " x 6 ³ / ₄ " x 1"	6000/cs.
76009000	76009000	7" x 7" + 1 ¹ / ₂ ", 0.70 MIL	2000/cs.



B. PRIME SOURCE® SUB SANDWICH BAGS PRIME SOURCE®

Poly sub sandwich bags.

76001030	76001030	9 ¹ / ₂ " x 7" +3	1000/cs.
76001029	76001029	15" x 7" +3	1000/cs.



C. SANDWICH BAGS ELKAY PLASTICS

FDA approved. From seamless tubing and bottom sealed for extra strength. No slit or side seals. 1¹/₂" lip, 1¹/₂" flip.

32810022	H07	7" x 7", 0.00085	1000/cs.
----------	-----	------------------	----------



D. DELI BAGS SANECK

Traditional high density deli bags with standard flip top. Attractively printed with 1-color/red Deli copy. Saddle packed for use on an A-frame or wall hook.

62420003	403121	10 ¹ / ₂ " x 8 ¹ / ₂ ", Clear	2000/cs.
----------	--------	---	----------



POLY BREAD/BAKERY BAGS

E. PRIME SOURCE® BAKERY BAGS PRIME SOURCE®

Polypropylene bakery bags.

76000130	76000130	5 ¹ / ₂ " x 3" x 24", Clear, 0.50 MIL	1000/cs.
76000149	76000149	5 ¹ / ₂ " x 4" x 29", Clear, 1 MIL	1000/cs.
76000395	76000395	5 ¹ / ₂ " x 4 ³ / ₄ " x 15", Clear	1000/cs.
76000146	76000146	5 ¹ / ₂ " x 4 ³ / ₄ " x 16", Clear, Heavyweight, 1 MIL	1000/cs.
76000387	76000387	5 ¹ / ₂ " x 4 ³ / ₄ " x 19", Clear	1000/cs.
76000150	76000150	5 ¹ / ₂ " x 4 ³ / ₄ " x 20", Clear, LDPE, 0.90 MIL, Bread	1000/cs.
75000060	75000060	6 ¹ / ₂ " x 29 ¹ / ₄ ", 0.90 MIL, French Bread	1000/cs.
76000153	76000153	8" x 6" x 18", Clear, 0.90 MIL, Angel Food	500/cs.
76000890	76000890	8" x 22" +3, Clear, LDPE, 0.90 MIL, Bread	1000/cs.
75000059	75000059	8 ³ / ₄ " x 21", 0.90 MIL, Italian Bread	1000/cs.
76000889	76000889	9" x 13" +4, Clear, LDPE, 0.90 MIL, Bread	1000/cs.
76002884	76002884	9" x 28 ¹ / ₂ " +3, Clear, Bread	1000/cs.
76000954	76000954	9 ¹ / ₂ " x 16" +4, Clear, LDPE, 0.85 MIL, Bread	1000/cs.
75000105	75000105	9 ¹ / ₂ " x 18" +1.5, Bread	1000/cs.
76000133	76000133	10" x 8" x 24", Clear, 1 MIL	500/cs.
76000936	76000936	12" x 16" +4, Clear, LDPE, 0.85 MIL, Bread	1000/cs.
62420041	62420041	12" x 20" +4, Clear	1000/cs.
76000891	76000891	15" x 22" +4, Clear, LDPE, 0.90 MIL, Bread	1000/cs.
76001082	76001082	15" x 22" +4, 1.0 MIL, Bread	1000/cs.



F. PRIME SOURCE® BAKERY BAGS PRIME SOURCE®

Linear low density polyethylene.

76001304	76001304	9" x 15" +1.5, 1.24 MIL	1000/cs.
76001306	76001306	12" x 6" x 24", White, 1.15 MIL	500/cs.



G. CLEAR N' TUFF® BAKERY BAGS FORTUNE PLASTICS

Non-perforated poly bakery bags.

13800002	160NP	5 ¹ / ₂ " x 3" x 24", Clear	1000/cs.
----------	-------	---	----------



H. BAKERY BAGS M-Z PACKAGING CORP

Polypropylene bakery bags.

28540991	11132538	11" x 13" x 3", 0.80 MIL	1000/cs.
----------	----------	--------------------------	----------

Poly Bread/Bakery & Food/Utility Bags



A. BAKERY BAGS SANECK

Clear polypropylene bakery bags offer excellent clarity and extend product freshness over traditional film types. This product is also wicketed for machine and automated loading.

62420396	733196	11" x 20"	1500/cs.
62424179	734179	11" x 13 1/2" +3, Clear	1000/cs.
62424182	734182	12" x 20" +4, 0.90 MIL, Clear	1000/cs.



B. BAKERY BAGS SANECK

Special micro-perforated clear polypropylene bag for the bakery. Specifically engineered to give products maximum shelf life while maintaining a firm crust.

62420397	733197	6" x 28"	2000/cs.
-----------------	--------	----------	----------



C. BAKERY BAGS SANECK

Polypropylene bakery bags.

62420071	733186	9" x 16" +4	1000/cs.
62425107	735107	9" x 18" +4, 1 1/2" Lip, Wicketed	1000/cs.



POLY FOOD/UTILITY BAGS

D. FRESHPAK® VACUUM POUCHES PRIME SOURCE®

High performance film. Excellent optics. Easy-to-seal. Higher puncture resistance and better machine performance.

75001826	75001826	7" x 11", 3 MIL	1000/cs.
75001829	75001829	8" x 10", 3 MIL	1000/cs.
75001830	75001830	8" x 12", 3 MIL	1000/cs.
75001838	75001838	10" x 13", 3 MIL	1000/cs.
75001854	75001854	12" x 16", 3 MIL	500/cs.
75001855	75001855	12" x 18", 3 MIL	500/cs.
75001861	75001861	14" x 16", 3 MIL	500/cs.



E. PRIME SOURCE® DRAWTAPE BAGS PRIME SOURCE®

Bag with drawtape closure.

76000721	76000721	18" x 21", 1.25 MIL, White/Red, 20 ct.	400/cs.
76000963	76000963	19" x 20", 1.25 MIL, Please Recycle, White/Green	400/cs.

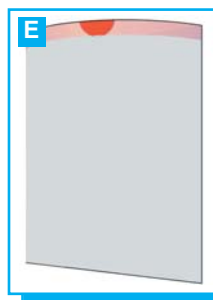

F. PRIME SOURCE® FOOD BAGS PRIME SOURCE®

Constructed of linear, low density polyethylene. Provides excellent clarity of product.

76000200	76000200	4" x 2" x 8", Clear	1000/cs.
76000660	76000660	5" x 4" x 24", Mediumweight	1000/cs.
76000152	76000152	5 1/2" x 4 3/4" x 28", 0.90 MIL, Clear	1000/cs.
76000204	76000204	6" x 3" x 15"	1000/cs.
76000662	76000662	6" x 3" x 15", 1 MIL, Clear, Mediumweight	1000/cs.
76000663	76000663	6" x 3 1/2" x 18", Clear, Mediumweight	1000/cs.
76000664	76000664	7" x 6" x 15", Clear, Regular	1000/cs.
76000665	76000665	8" x 3" x 15", 0.90 MIL, Clear, Mediumweight	1000/cs.
76000207	76000207	8" x 4" x 18", Clear	1000/cs.
76000666	76000666	8" x 4" x 18", Clear, Regular	1000/cs.
76000667	76000667	8" x 4" x 18", 1.20 MIL, Clear, X-Heavyweight	1000/cs.
76000206	76000206	10" x 8" x 24", Clear	500/cs.
76000201	76000201	10" x 8" x 24", Clear, Heavyweight	500/cs.

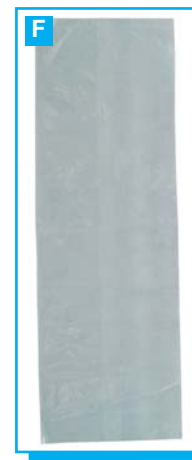

BAGS

Poly Food/Utility Bags



A. PRIME SOURCE® POLY FOOD BAGS

PRIME SOURCE®

Polypropylene bags. Non-perforated.

76000437	76000437	5" x 4 1/2" x 15", 0.90 MIL, Clear	1000/cs.
76000151	76000151	5 1/2" x 3" x 24", 1 MIL, Clear	1000/cs.
76000432	76000432	6" x 3" x 12", 1 MIL, Clear	1000/cs.
76000147	76000147	6" x 3" x 15", 1 MIL, Clear	1000/cs.
76000208	76000208	8" x 4" x 18", 0.90 MIL, Clear	1000/cs.
76000434	76000434	8" x 4" x 18", 1 MIL, Clear	1000/cs.
76000435	76000435	8" x 4" x 18", 1.50 MIL, Clear	500/cs.
76007817	76007817	8" x 4" x 18", 2 MIL, Clear	1000/cs.
76000145	76000145	12" x 6" x 24", 2 MIL, Clear	500/cs.
75000064	75000064	14" x 26" +1/4 Lip, 0.90 MIL, Clear	500/cs.
76000018	76000018	24" x 24", 8 MIC, Clear	1000/cs.

Meat & Poultry Bags

76000132	76000132	4" x 2" x 8", 0.52 MIL, Clear	1000/cs.
76000418	76000418	4" x 2" x 12", 0.52 MIL, Clear	1000/cs.
76000141	76000141	6" x 3" x 12", 0.65 MIL, Clear	1000/cs.
76000135	76000135	6" x 3" x 15", 0.70 MIL, Clear	1000/cs.
76000142	76000142	8" x 3" x 15", 0.70 MIL, Clear	1000/cs.
76000402	76000402	8" x 4" x 18", 0.60 MIL, Clear, Lightweight	1000/cs.
76000139	76000139	10" x 4" x 20", 0.76 MIL, Clear	1000/cs.
76000405	76000405	10" x 8" x 24", 0.80 MIL, Clear, Mediumweight	500/cs.

Poultry Bags

76000397	76000397	6" x 3" x 15", Heavyweight	1000/cs.
76000409	76000409	8" x 4" x 18", 1.75 MIL, Clear, X-Heavyweight	500/cs.
76000148	76000148	8" x 4" x 18", 2 MIL, Clear	500/cs.
76000144	76000144	12" x 8" x 30", 1 MIL, Clear	500/cs.

B. PRIME SOURCE® SEAFOOD BAGS

PRIME SOURCE®

High density polyethylene.

75000058	75000058	7 1/2" x 4" x 12", 0.95 MIL	1000/cs.
----------	----------	-----------------------------	----------

C. PRIME SOURCE® SNAP OFF BAGS

PRIME SOURCE®

Snap off bag with ties.

76000406	76000406	10" x 14", 0.65 MIL, Clear	1000/cs.
76000407	76000407	21" x 35", 0.90 MIL, Clear	200/cs.

D. BUN PAN COVERS

FORTUNE PLASTICS

Bun pan covers on a roll in dispenser box.

13801815	D2135	21" x 6" x 35"	200/cs.
----------	-------	----------------	---------

E. CLEAR N' TUFF® FOOD/UTILITY BAGS

FORTUNE PLASTICS

Clear poly food bags.

13800150	100NP	4" x 2" x 8", 0.52 MIL	1000/cs.
13807305	101NP	4" x 2" x 12", 0.52 MIL	1000/cs.
13801065	109NP	6" x 3" x 12", 0.65 MIL	1000/cs.
13801079	120NP	8" x 3" x 15", 1.50 MIL	1000/cs.
13801105	127NP	8" x 4" x 18", 0.60 MIL	1000/cs.
13801110	127NPM	8" x 4" x 18", Medium	1000/cs.
13801115	127NPH	8" x 4" x 18", Heavy	1000/cs.
13801145	127NPEXH	8" x 4" x 18", 1.75 MIL, Extra Heavy	500/cs.
13801150	130NP	10" x 4" x 20", 0.76 MIL	1000/cs.
13800089	152NPEXH	10" x 8" x 24", Extra Heavy	500/cs.
13801180	153NPH	12" x 8" x 30", 1.80 MIL, Heavy	500/cs.

F. POLY BAGS

FORTUNE PLASTICS

Wicketed.

13805300	12205SW	12" x 20 1/2" +3, Clear	1000/cs.
----------	---------	-------------------------	----------

Linear low density poly bags.

13800029	91380023	8" x 4" x 26", Clear	500/cs.
----------	----------	----------------------	---------

BAGS

Poly Food/Utility & Header/Produce/Roll Bags



A. FOOD & UTILITY BAGS HERITAGE BAG

Ideal for food preparation and storage. Keeps food safe and fresh for later usage. FDA approved and individually folded.

38990285 *F2735RC* 21" x 6" x 35", Clear, Regular 200/cs.



POLY HEADER/PRODUCE/ROLL BAGS

B. PRIME SOURCE® HEADER BAGS PRIME SOURCE®

Printed poly header bags.

62429757 *62429757* 10" x 15", Fresh Catch 1800/cs.



C. PRIME SOURCE® PRODUCE BAGS PRIME SOURCE®

Clear produce bags.

75000066 *75000066* 15" x 19" 2000/cs.



D. PRIME SOURCE® PRODUCE BAGS PRIME SOURCE®

Constructed of linear, low density polyethylene. Provides excellent clarity of product.

76000392 *76000392* 8" x 3" x 20", Clear 1000/cs.

76001623 *76001623* 16" x 23" +1.5, Clear, Wicketed, 1 MIL 500/cs.



E. PRIME SOURCE® PRODUCE BAGS PRIME SOURCE®

Heavy PTO roll bags.

76001825 *76001825* 6" x 8", 0.85 MIL, w/Ties 2000/cs.

76001826 *76001826* 12" x 17", 10 MIC 4360/cs.

76001827 *76001827* 14" x 24", 9 MIC 4000/cs.

76001824 *76001824* 18" x 24", 0.85 MIL, w/Ties 250/cs.

F. QUIKSTAR® PRODUCE BAGS ASSOCIATED PACKAGING TECH

Versatile installation options including above the wet-wall case. Anytime restocking allows dispensers to always have plenty of bags available. "One-At-A-Time" dispensing eliminates bag waste. Tables, headerless design leaves nothing behind. Narrow footprint maximizes product display area. Star Seal bottom for exceptional strength.

18300689 *1002586* 12" x 20", 5-A-Day 4000/cs.



G. PULL-N-PAK® ROLL BAGS CROWN POLY

Encourage your shoppers to live healthy lifestyles by eating more fruits and vegetables.

5-A-Day is sponsored by the Produce for Better Health Foundation which includes the National Cancer Institute and the U.S. Department of Agriculture. Enhanced self opening. High Density (HMW-HDPE). Natural film color.

28160113 *10113* 15" x 20", 5-A-Day 3000/cs.



H. PULL-N-PAK® ROLL BAGS CROWN POLY

The market leader and proven bagging solution for produce, meat, bakery, and bulk. The Pull-N-Pak® is the only system that dispenses only one bag at a time to the last bag on the roll, eliminating customer frustration and reducing bag waste. Provides pre-opened bags.

Wide-opening, static free. Star-sealed bottom. Leak-proof. Pull-N-Pak® bags used 50% less raw materials and less energy to produce and ship than standard bags. Recyclable.

28160732 *10732* 15" x 24", Fresh Corn & Yams, Yellow 1260/cs.

28160310 *10310* 16" x 28", Fresh Greens, Green 1900/cs.

I. PRODUCE BAGS FORTUNE PLASTICS

Plastic produce bags.

13801080 *114P* 6" x 3 1/2" x 15", Clear 1000/cs.

13801085 *117P* 6" x 3 1/2" x 18", 0.70 MIL, Clear 1000/cs.



BAGS

Produce/Roll Bags/Rack/Ties/Ice & Reclosable Bags



A. PLANT SLEEVE **SANECK**
 Printed florist shop bouquet sleeve.
62422554 733980 13" x 25½" x 4" 5/100/cs.



B. STAR POLY BAGS **UNISTAR PLASTICS**
 High density polyethylene.
77716520 19910025 14" x 18", More Matters 3200/cs.

BAG DISPENSER RACK



C. BAG DISPENSER RACK **OMEGA PLASTICS**
 Front mount bag rack dispenser.
52490143 50912 1/ea.

TWIST TIES



D. TWIST TIES **DES-L INDUSTRIES**
 Paper coated wire ties.
290510345 316X4R 3/16" x 4", Red 2000/cs.



E. TWIST-EASE™ CARTRIDGE TWIST TIES **TWIST-EASE**
 The standard 4" tie is the basic tie used in most produce departments as a bag closure. The simplest, most cost-effective customer preferred system in use today. Each pack can be refilled in just seconds (click refills) with no costly spills all over the floor or in product displays.

66991401 41401 4", Green 4800/cs.
66991501 41501 4", Green 19200/cs.

ICE BAGS



F. PRIME SOURCE® POLY ICE BAGS **PRIME SOURCE®**
 Freezer-safe, clear polyethylene ice bags are resistant to punctures, rips and tears. Optional drawstrings seal bags easily and securely.

75001778 75001778 8 lb., 8" x 3" x 20", 1 Color Print, Drawstring 500/cs.
75001776 75001776 8 lb., 8" x 3" x 20", 1 Color Print, Standard 1000/cs.
75001779 75001779 8 lb., 8" x 3" x 20", 3 Color Print, Drawstring 500/cs.
75001777 75001777 8 lb., 8" x 3" x 20", 3 Color Print, Standard 1000/cs.
76000019 76000019 Approx. 10 lb., 7" x 4" x 24", Clear 1000/cs.
75001782 75001782 10 lb., 8" x 4" x 22", 1 Color Print, Drawstring 500/cs.
75001780 75001780 10 lb., 8" x 4" x 22", 1 Color Print, Standard 1000/cs.
75001783 75001783 10 lb., 8" x 4" x 22", 3 Color Print, Drawstring 500/cs.
75001781 75001781 10 lb., 8" x 4" x 22", 3 Color Print, Standard 1000/cs.



G. ICE BAGS **FORTUNE PLASTICS**
 Printed low density flat ice bags.
13802112 IC10 10 lb., 12" x 21", Clear 1000/cs.

RECLOSABLE BAGS



H. PRIME SOURCE® RECLOSABLE BAGS **PRIME SOURCE®**
 Low density polyethylene.
75001844 75001844 4" x 4", Clear, 2 MIL 1000/cs.



I. PRIME SOURCE® SLIDER BAGS **PRIME SOURCE®**
 Slider deli bags.
76001543 76001543 8½" x 11", 3-Color 1000/cs.
75000023 75000023 10½" x 8", Fresh From Our Deli 2000/cs.

BAGS

Reclosable Bags



A. PRIME SOURCE® SLIDER BAGS PRIME SOURCE®

Low density polyethylene.

75001849	75001849	10" x 7", Clear, 3 MIL	250/cs.
75001847	75001847	12" x 12", Clear, 2 MIL	500/cs.
75001846	75001846	15" x 16", Clear, 2 MIL	500/cs.



B. PRIME SOURCE® ZIPLOCK BAGS PRIME SOURCE®

Poly ziplock bags.

76000438	76000438	5" x 8", 2 MIL	1000/cs.
76000440	76000440	8" x 10", 2 MIL	1000/cs.
76000527	76000527	8" x 10 1/2", Deli Fresh	1000/cs.
76004527	76004527	9 1/2" x 10 1/2" +5, Deli Fresh	2000/cs.
76000441	76000441	10" x 12", 2 MIL	1000/cs.



C. SLIDELOCK DELI BAGS PRIME SOURCE®

Easy-to-use with a secure reclosable slidelock closure. Leak and odor resistant. Saddle pack dispensing.

75001302	75001302	10" x 8", Our Deli®	1000/cs.
75001310	75001310	10" x 8", Plain	1000/cs.
75003002	75003002	10" x 8 1/4"	1000/cs.
76007818	76007818	15" x 16", Clear, 3 MIL	500/cs.

Bottom load deli bags.

75001341	75001341	10" x 8", Our Deli®	1000/cs.
----------	----------	---------------------	----------



D. GLAD® ZIPPER STORAGE BAGS CLOROX

Seal in freshness and protect your food. Only Glad-Lock® zipper bags have the yellow-and-blue-make-Green Seal™; when you see the Green Seal™, you know the bag is closed.

Kosher.

38385050	55050	1 gal.	240/cs.
----------	-------	--------	---------



E. ZIPLOC® BAGS DIVERSEY

Not all products are created equal. Now Ziploc® brand bags, the trusted name in food storage, are available in convenient, economical, food service size packs. Ziploc® brand bags are strong and reliable. Ideal for keeping food fresh, clean and delicious in foodservice operations.

15203816	CB003813	Freezer, 1 qt., 9/40 ct. Retail Pack	360/cs.
15200063	94604	Freezer, 1 gal.	250/cs.
15200382	CB003820	Freezer, 1 gal., 9/30 ct. Retail Pack	270/cs.
15204605	94605	Freezer, 2 gal.	100/cs.
15200390	CB003905	Sandwich, 12/50 ct.	600/cs.
15200058	94600	Sandwich, 500 ct.	500/cs.
15200059	94601	Storage, 1 qt., 500 ct., 1.75 MIL	500/cs.
15200060	94602	Storage, 1 gal., 250 ct., 1.75 MIL	250/cs.
15200062	94603	Storage, 2 gal., 100 ct., 1.75 MIL	100/cs.



F. RECLOSABLE BAGS ELKAY PLASTICS

Clear line single track seal top bags. Standard-duty, general use reclosable bags that are excellent for storing and displaying all types of products. Offset lip and ridges make gripping and opening easier. Meets FDA requirements for food applications. Inner packs of 100.

Dimensions represent the interior, usable portion of the bag.

32813508	F20508	5" x 8", 0.002	10/100/cs.
32813609	F20609	6" x 9", 0.002	10/100/cs.
32813808	F20808	8" x 8", 0.002	10/100/cs.

G. RECLOSABLE SEAL TOP BAGS ELKAY PLASTICS

These low density polyethylene (LDPE) bags are a natural choice for food service. The zipper type closure makes these bags reclosable and perfect for items that need to be kept fresh and repackaged. Bags come in standard storage volume capacities.

32810046	F21012G	1 gal. w/Write-On Strips & LK Logo, 0.00175	250/cs.
----------	---------	---	---------



BAGS

Reclosable Bags/Pan Rack Cover



A. HEFTY® ONEZIP® STORAGE BAGS PACTIV

One click and you know it's closed. Easy-to-use slider closes the first time, every time. No need to pinch or line up tracks to close. Large write-on label.

16208141 R81417 1 gal. 204/cs.



B. REYNOLDS® QWIK SEAL® RECLOSABLE FOODSERVICE BAGS PACTIV REYNOLDS

Save time and space with tough, clear Reynolds® Qwik Seal® reclosable bags. The unique triple track seal locks in freshness quickly and securely. Versatile, clear Qwik Seal® bags are ideal for space-saving storage, no-leak transport and smooth service. Strong Qwik Seal® bags can be stacked without fear of bursting. The self-dispensing carton makes Qwik Seal® easy to use for take-home foods, bulk foods and over-the-counter sales.

17306500 RS65 Sandwich, 6⁵/₈" x 5⁷/₈", 1.15 MIL 500/cs.

17307800 RS78 1 qt., 7" x 8", 1.75 MIL 500/cs.

17301400 RS1011 1 gal., 10⁹/₁₆" x 11", 1.75 MIL 250/cs.



C. HOT FOOD BAGS ROBBIE MANUFACTURING

Chicken Bags

Reinforced handle. Keeps moist products tender, fried products crispy. Keeps window clear. Fits up to 30% more product in the deli case. Re-sealable zipper. Leak resistant. Microwave safe.

17509827 09827 12³/₄" x 8" + 5¹/₂" Lip 250/cs.

Hot N Handy® Pouch

Hot N Handy® pouches are made of a high temperature film with heat resistant inks that hold up well in the harsh conditions of a typical heated display case. They are also designed to hold up to reheating in a microwave oven, a big convenience for consumers.

17508292 10135 19¹/₂" x 7" x 7", Fresh N Tasty 250/cs.

Vented Chicken Bags

Microwave safe. Reclosable zipper. Printed "Fresh to Go - Hot, Crisp & Full of Flavor".

17504274 14274 4 pc., Fresh to Go 250/cs.

17504275 14273 8 pc., Fresh to Go 250/cs.



D. RECLOSABLE BAGS SANECK

Stock poly ziplock bags.

62420095 733123 10¹/₂" x 8" 1000/cs.



E. DELI BAGS SPECTRUM PLASTICS

Slide closure.

11460124 1510127 10" x 8", Clear, 1.25 MIL 1000/cs.



PAN RACK COVER

F. PRIME SOURCE® RACK COVER PRIME SOURCE®

Poly rack cover.

75001750 75001750 52" x 80" 50/cs.

Foil Sheets



FOIL SHEETS

A. PRIME SOURCE® ALUMINUM FOIL POP UP SHEETS

PRIME SOURCE®

Perfect for freezing, storing and cooking in the foodservice industry. Pop-up dispenser box delivers one sheet at a time.

75000950	75000950	9" x 10 ³ / ₄ ", 500 ct.	3000/cs.
75001220	75001220	12" x 12 ³ / ₄ ", 200 ct.	2400/cs.
750012505	75001250	12" x 12 ³ / ₄ ", 500 ct.	500/cs.
75001250	75001250	12" x 12 ³ / ₄ ", 500 ct.	3000/cs.



B. 3-IN-ONE™ FOODSERVICE FOIL SHEETS

BAGCRAFT/PAPERCON

Exclusive foil/paper lamination retains heat, absorbs steam, resists curl. Excellent deadfold capabilities. Cardboard dispenser keeps sheets flat. Hamburger/cheeseburger/special.

10908121	300812	10 ¹ / ₂ " x 14", Red/Gold	2000/cs.
----------	--------	--	----------



C. FOIL INSULATED WRAPS

BAGCRAFT/PAPERCON

Honeycomb design creates air pockets for superior heat retention. Excellent for foods displayed in heated cabinets. Paper liner provides moisture absorption and keeps buns fresh. Foil spreads heat and maintains a fresh premium appearance.

10900853	300853	10 ¹ / ₂ " x 14", Cheeseburger	2000/cs.
10900854	300854	10 ¹ / ₂ " x 14", Hamburger/Cheeseburger/Special	2000/cs.
10900816	300815	10 ¹ / ₂ " x 14", Silver	2000/cs.
10901806	300806	12" x 12", Silver	2000/cs.
10900841	300841	14" x 16", Silver	1000/cs.



D. INTERFOLDED QUILTED® FOIL POP-UP SHEETS

PACTIV

Ideal for facilitating freezing, storage and cooking in all types of foodservice applications.

16201310	W71	9" x 10 ³ / ₄ ", 200 ct.	2400/cs.
16206560	W72	9" x 10 ³ / ₄ ", 500 ct.	3000/cs.
16201320	W70	12" x 10 ³ / ₄ ", 200 ct.	2400/cs.



E. REYNOLDS® CUSHION-FOLD® SANDWICH WRAP

PACTIV REYNOLDS

Service is fast and easy with Reynolds® Cushion-Fold® sandwich wraps, the wrap with superior dead fold to conform tightly to every shape. Triple thermal barrier protection (an outer layer of foil; soft, absorbent paper laminate; insulating air pockets between the two layers) keeps hot foods hot and cold foods cold and prevents leaks. Cushion-Fold® sandwich wraps give your products the quality image that only comes with foil. Wraps are attractively patterned with specific sandwich identification.

17307524	7524	10 ¹ / ₂ " x 14", Plain	2500/cs.
----------	------	---	----------



F. REYNOLDS® FOIL INTERFOLDED SHEETS

PACTIV REYNOLDS

Pop up one-at-a-time for fast service. Choose plain, gold or striped foil sheets. Wide selection of sizes to help prevent waste. All interfolded sheets come with dual Universal Product Codes (UPC) and Kosher U on every box. Sheets can be used for wrapping potatoes, sandwiches, biscuits, etc.

17307010	701	8" x 10 ³ / ₄ ", 500 ct., Plain	3000/cs.
17300712	712	9" x 10 ³ / ₄ ", 200 ct., Gold	2400/cs.
16203136	710	9" x 10 ³ / ₄ ", 200 ct., Plain	2400/cs.
16203137	711	9" x 10 ³ / ₄ ", 500 ct., Plain	3000/cs.
16203334	720M	12" x 10 ³ / ₄ ", 200 ct., Metro	2400/cs.
16203335	721M	12" x 10 ³ / ₄ ", 500 ct., Metro	3000/cs.
17301720	720	12" x 10 ³ / ₄ ", 200 ct., Plain	2400/cs.
16203140	721	12" x 10 ³ / ₄ ", 500 ct., Plain	3000/cs.





Foil Rolls



FOIL ROLLS

A. PRIME SOURCE® ALUMINUM FOIL PRIME SOURCE®

Perfect for freezing, storing and cooking in the foodservice industry. Corrugated cutterbox for easy tear.

75001210	75001210	12" x 1000', Lightweight	1/r.
75001850	75001850	18" x 500', Standard	1/r.
75001810	75001810	18" x 1000', Standard	1/r.
75002050	75002050	18" x 500', Heavy-Duty	1/r.
75002010	75002010	18" x 1000', Heavy-Duty	1/r.
75002011	75002011	24" x 1000', Heavy-Duty	1/r.



B. FOIL ROLL HFA

Foodservice aluminum foil roll.

31042408	12408	24" x 1000', Heavy-Duty	1/r.
----------	-------	-------------------------	------



C. MEDALLION™ FOIL ROLLS HFA

Foodservice foil rolls.

31041203	11203	12" x 1000', Standard	1/r.
31041803	51803	18" x 500', Standard	1/r.
31045180	51807	18" x 500', Heavy-Duty	1/r.



D. CLASSIC™ ALUMINUM ROLL FOIL PACTIV

Foil dispenser roll. The Classic™ line broadens Pactiv's offering to provide end-user flexibility, compete with import brands, and optimize costs for specific foodservice aluminum applications.

162024011	WM117	18" x 1000'	1/r.
-----------	-------	-------------	------



E. FOIL DISPENSER ROLLS PACTIV

Ideal for facilitating freezing, storage and cooking in all types of foodservice applications.

162024041	WC12	12" x 1000', Classic	1/r.
16206500	W12	12" x 1000', Standard	1/r.
16206505	W18	18" x 500', Standard	1/r.
16206525	W28	18" x 500', Heavy-Duty	1/r.
16206504	W17	18" x 1000', Standard	1/r.
16206510	W23	18" x 1000', Heavy-Duty	1/r.



F. REYNOLDS® ALUMINUM FOIL PACTIV REYNOLDS

Economical and practical, wherever its used. Each carton is wrapped in shrink film to help keep cartons cleaner and more sanitary. Set-up instructions and directions for use in Spanish, French and English. Easy dispensing system makes cutting foil a quick and easy operation. Foil retains heat naturally to help reduce energy costs. Large, easy-to-read item numbers and size. All Reynolds® foil products have been certified Kosher U.

16203124	611	12" x 1000', Standard	1/r.
16203326	611M	12" x 1000', Metro, Standard	1/r.
17306200	620	12" x 500', Heavy-Duty	1/r.
16203126	614	18" x 500', Standard	1/r.
16203327	614M	18" x 500', Metro, Standard	1/r.
16203130	624	18" x 500', Heavy-Duty	1/r.
16203329	624M	18" x 500', Metro, Heavy-Duty	1/r.
16203127	615	18" x 1000', Standard	1/r.
16203131	625	18" x 1000', Heavy-Duty	1/r.
17306270	627	24" x 1000', Heavy-Duty	1/r.

Foil Rolls/Foodservice Film - Sheets



A. REYNOLDS® ALUMINUM FOIL PACTIV REYNOLDS

Versatile, strong and economical foodservice foil retains heat naturally to help reduce energy costs. Whether used in cooking, serving, storing or freezing, Reynolds® foil does the job easily and economically.

17306671 667 18" x 50', Heavy-Duty 20/cs.



FOODSERVICE FILM - SHEETS

B. PRIME SOURCE® POLY SHEETS PRIME SOURCE®

Food grade LDPE poly sheets.

76000875 76000875 22" x 30", Clear, 1 MIL 500/cs.



C. PRIME SOURCE® TRUE TARE SCALE SHEETS PRIME SOURCE®

High density scale sheets.

76008900 76008900 9" x 12", Natural 4000/cs.

D. POLYPROPYLENE SHEETS ALLIED CONVERTERS

Polypropylene sheets.

204801165 1616PP 16" x 16", Clear, Perforated 1000/cs.

204801185 1818PPNP 18" x 18", Clear, Non-Perforated 1000/cs.

204802115 2121PP 21" x 21", Clear, Perforated 1000/cs.



E. E15 PERFORATED CLING FILM ANCHOR PACKAGING

Temporary overwrap of all food items. Pre-measured, perforated sheets for the exact size every time with less waste. Dispenser box keeps film sanitary and eliminates the need for tier dispensers. Sticks well to china, glass, plastic and stainless steel.

10801565 E1565 6" x 5", 3000 ct. 1/r.

10800026 E151010 10" x 10", 1900 ct. 1/r.

10800025 E151212 12" x 12", 1600 ct. 1/r.

10801414 E151414 14" x 14", 1200 ct. 1/r.

10809501 E151515 15" x 15", 1100 ct. 1/r.



F. CLEAR POLYETHYLENE SHEETS BAGCRAFT/PAPERCON

Clear polyethylene protection sheets for use as scale sheets, pick-sheets, separators, and liners. Easy release from fresh, frozen or packaged products. Waterproof and greaseproof to retain products appearance and freshness. Can be used in microwave. Convenient interfolded pop-up dispenser boxes. FDA approved.

16401909 014006 6" x 10³/₄", CP6 10000/cs.

16400088 014008 8" x 10³/₄", CP8 10000/cs.

16400015 014010 10" x 10³/₄", CP10 10000/cs.

16401908 014012 12" x 10³/₄", CP12 10000/cs.

16401907 014015 15" x 10³/₄", CP15 10000/cs.



G. SATIN PAC DELI FILM GEORGIA-PACIFIC

High-density polyethylene inter-folded all purpose deli sheets. Provides barrier to contain wetness. Frozen foods separate without thawing.

15004920 S8 8" x 10³/₄", 1000 ct., Clear 10000/cs.

15004910 S10 10" x 10³/₄", 1000 ct., Clear 10000/cs.

15005506 S12 12" x 10³/₄", 1000 ct., Clear 10000/cs.

15000151 S15 15" x 10³/₄", 1000 ct., Clear 10000/cs.



H. PLASTIC POP-UP DELI SHEETS INTEPLAST CORPORATION

Inteplast plastic deli sheets are inter-folded with pop-up style design for easy dispensing. HDPE clear film. Greaseproof, waterproof, and non-absorbent. Microwavable and freezable. FDA approved.

03600161 DS8L 10³/₄"L, Junior, 0.50 MIL 10000/cs.

03600163 DS12L 10³/₄"L, Master, 0.50 MIL 10000/cs.





Foodservice Film - Sheets & Rolls

FOODSERVICE WRAPS & PROCESSING



A. QUICKSHEETS®			PAK-SHER
Printable surface for customization. Cost effective against paper. Interfolded design for easy dispensing. Moisture proof design makes for no mess.			
16300063	1728	6" x 10 ³ / ₄ ", Natural, Q-6	1/ea.
16300035	1729	8" x 10 ³ / ₄ ", Natural, Q-8	10/1000/cs.
16300014	1731	10" x 10 ³ / ₄ ", Natural, Q-10	10/1000/cs.
16300056	1733	12" x 10 ³ / ₄ ", Natural, Q-12	10/1000/cs.
16300011	1734	15" x 10 ³ / ₄ ", Natural, Q-15	10/1000/cs.



B. REYNOLDS® FOODSERVICE FILM		PACTIV REYNOLDS
Anti-fog with excellent clarity, brilliance and cling in the best dispenser. Built-in locking tabs hold cutter blade and lid firmly in place. High impact inserts help protect film and allows for easier turning.		
17309200	920	6" x 5", 3000 ct., Clear 1/r.
17309300	930	12" x 12", 1600 ct., Clear 1/r.

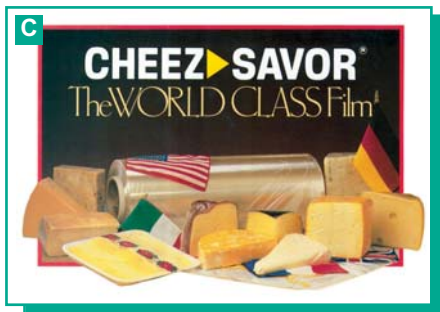

C. RM701 CHEEZ SAVER FILM		ROBBIE MANUFACTURING
Keeps cheese moist better than ordinary meat or PVC film. Keeps oxygen and air moisture out, protecting against mold and extending shelf life. Hold in odors of strong cheeses. Protects natural cheese colors by screening out ultraviolet light. Use R-1, R-2, or R-3 dispensers. 50 gauge high barrier cling/shrink PVC.		
17505281	00232	11" x 11", 1300 ct., Clear 1300/cs.

FOODSERVICE FILM - ROLLS



D. HI-VALU ALL PURPOSE CLING FILM		HI-VALU
Small box design is environmentally friendly by saving on corrugate. Increase profits per SKU. Ship and stock more rolls in the same space as before, reducing transportation and carrying costs per unit. Heavy-duty, self-dispensing cutter boxes come with lock top design, improved film exit slot, and hand holes for easy transportation. An extended front flap allows the box to maintain structural integrity. Flap includes a standard, full-length cutting blade with an improved cutting edge. Film roll mounted on roller-core plugs for ease in dispensing and to reduce drag. An all purpose, tinted foodservice film with excellent cling properties, providing outstanding clarity and protection.		
73000010	73000010	12" x 2000' 1/ea.
73000009	73000009	18" x 2000' 1/ea.
73000011	73000011	24" x 2000' 1/ea.



E. PRIME SOURCE® CLING FILM		PRIME SOURCE®
All purpose cling film in easy-to-use, self-dispensing cutter box. Safe cutting edge that cuts cleanly and effortlessly.		
75003820	75003820	12" x 1000' 1/ea.
75003821	75003821	12" x 2000' 1/ea.
75003822	75003822	12" x 3000' 1/ea.
75003835	75003835	15" x 2000' 1/ea.
75003830	75003830	18" x 1000' 1/ea.
75003831	75003831	18" x 2000' 1/ea.
75003832	75003832	18" x 3000' 1/ea.
75003838	75003838	24" x 2000' 1/ea.

Foodservice Film - Rolls



A. PRIME SOURCE® FILM PRIME SOURCE®

Super-stretch, breathable foodservice film. Excellent heat-seal properties. Outstanding clarity and sparkle. Consistent quality from roll to roll.

Meat

75003811	75003811	12" x 5000'	Clear, 60 GA	1/r.
76003840	76003840	12" x 5000'	Clear, Economy	1/r.
75003823	75003823	13" x 5000'	Clear, 60 GA	1/r.
75003812	75003812	14" x 5000'	Clear, 60 GA	1/r.
76003841	76003841	14" x 5000'	Clear, Economy, Imported from Mexico	1/r.
75003886	75003886	14" x 5000'	Clear, Economy, Spanish/English	1/r.
75003851	75003851	15" x 4000'	Clear, 60 GA	1/r.
75003813	75003813	15" x 5000'	Clear, 60 GA	1/r.
76003842	76003842	15" x 5000'	Clear, Economy, Imported from Mexico	1/r.
75003887	75003887	15" x 5000'	Clear, Economy, Spanish/English	1/r.
75003817	75003817	16" x 5000'	Clear, 60 GA	1/r.
75003814	75003814	17" x 5000'	Clear, 60 GA	1/r.
76003843	76003843	17" x 5000'	Clear, Economy	1/r.
75003815	75003815	18" x 5000'	Clear, 60 GA	1/r.
75003888	75003888	18" x 5000'	Clear, Economy	1/r.
75003852	75003852	19" x 4000'	Clear, 60 GA	1/r.
75003816	75003816	19" x 5000'	Clear, 60 GA	1/r.
75003818	75003818	20" x 5000'	Clear, 60 GA	1/r.
75003824	75003824	21" x 5000'	Clear, 60 GA	1/r.
75003819	75003819	23" x 5000'	Clear, 60 GA	1/r.

Produce

75003845	75003845	14" x 5000'	Clear, 58 GA	1/r.
75003842	75003842	15" x 5000'	Clear, 58 GA	1/r.
75003841	75003841	16" x 5000'	Clear, 58 GA	1/r.
75003843	75003843	17" x 5000'	Clear, 58 GA	1/r.
75003856	75003856	17" x 5000'	Green, 60 GA	1/r.
75003846	75003846	18" x 5000'	Clear, 58 GA	1/r.



B. PRIME SOURCE® MEAT FILM PRIME SOURCE®

Hand wrap meat film rolls.

75003897	75003897	12" x 5000'	Clear	1/r.
75003898	75003898	14" x 5000'	Clear	1/r.
75003899	75003899	15" x 5000'	Clear	1/r.
75003900	75003900	18" x 5000'	Clear	1/r.



C. PRIME SOURCE® PREMIUM DUAL-LAYER FILM PRIME SOURCE®

Environmentally conscious multipurpose meat, deli and produce films for packer processing and in-store wrapping. Twice the proven fresh food protective benefits of PVC food film. Increased strength, stretch, puncture resistance and smart memory for package handling. Increased productivity with extended roll lengths for fewer changeovers and trimmed roll edges for smooth runs down to the core. Economical material costs. Innovative dual-layer film that uses less material than conventional single-layer films. More renewable materials and energy efficient production than other plastics.

75003893	75003893	15" x 5000'	Clear	1/r.
75003894	75003894	17" x 5000'	Clear	1/r.
75003895	75003895	18" x 5000'	Clear	1/r.
75003896	75003896	19" x 5000'	Clear	1/r.

D. ELITE™ STRETCH MEAT FILM AEP INDUSTRIES

Tough two layer film with improved puncture resistance. Elite™ is designed for machine wrapping with centered rolls and trimmed edges. Excellent oxygen permeability for outstanding shelf life. Great memory to withstand rough handling at point of purchase. Clear Elite™ film gives your customer a picture perfect view. Resin-free anti-fog never clouds the picture. Lighter gauge is environmentally friendly while reducing your packaging cost.

11200256	351315	15" x 5000'	50 GA	1/ea.
11200255	351318	18" x 5000'	50 GA	1/ea.





Foodservice Film - Rolls

FOODSERVICE WRAPS & PROCESSING



A. MILER FILM AEP INDUSTRIES

All purpose cling film.
11205523 33111800 18" x 5280' 1/ea.



B. RESINITE® STRETCH MEAT FILM AEP INDUSTRIES

This film is used on stretch hand wrap machines from Exact, Heat Sealing and Clamco, etc. This film is also used on semi-automatic and automatic machines from Hobart, Weldotron, Exact and Toledo Scale. Provides a softer film with increased stretch that is more easily handled by hand and by automatic wrapping machinery.
11200022 35001500 15" x 5000', Clear, 62 GA 1/ea.
11200220 35001800 18" x 5000', Clear, 62 GA 1/ea.



C. ZIPSAFE® FOOD WRAP FILM AEP INDUSTRIES

Professional grade for excellent cling. Slide cutter will cut film not fingers. FDA sanctioned for direct food contact. Kosher approved.
11202122 ZP122000 12" x 2000', Clear 1/ea.
11202182 ZP182000 18" x 2000', Clear 1/ea.



D. CRYSTAL WRAP FOODSERVICE FILM ANCHOR PACKAGING

Heavy-duty foodservice film with excellent cling and puncture properties. A blue tinted film with outstanding clarity for foodservice professionals. All of our cutter boxes come with lock top design, improved film exit slot, and hand holes for easy transportation. Our improved cutting edge and extended front flap allow the box to maintain structural integrity.
10801836 7301235 12" x 2000' 1/r.
10801835 7301835 18" x 2000' 1/r.



E. PURITY WRAP™ ALL PURPOSE FOOD FILM ANCHOR PACKAGING

Premium grade foodservice film with excellent cling and puncture properties. A blue tinted film with outstanding clarity for foodservice professionals. All of our cutter boxes come with lock top design, improved film exit slot, and hand holes for easy transportation. Our improved cutting edge and extended front flap allow the box to maintain structural integrity. Anchor Packaging has added a Dri-Gard™ grease and water box protectant to our premium film lines. Dri-Gard™ is a revolutionary box coating that will give added resistance to moisture, grease, and spills that are commonplace in the kitchen. Dri-Gard™ preserves box integrity. With Dri-Gard™, box can be wiped clean with a damp cloth.
10801220 7309422 12" x 2000' 1/r.
10801820 7309482 18" x 2000' 1/r.
10809442 7309442 24" x 2000' 1/r.



F. THE MILER® INSTITUTIONAL CLING FILM ANCHOR PACKAGING

All purpose cling film. Used in conjunction with Anchor Miler dispenser for restaurants and institutions.
10801200 MF12 12" x 5280' 1/r.
10801800 MF18 18" x 5280' 1/r.



G. GLAD® CLING WRAP CLOROX

Glad® brings you the best in food storage solutions. Clings tight to help keep food fresh. Easy to handle and microwave-safe, so you can defrost or reheat with this versatile wrap.
38380684 60684 12" x 100' 16/cs.



H. REYNOLDS® FOODSERVICE FILM PACTIV

Metro line foodservice film in easy-to-use cutter box.
16203341 910M 12" x 2000' 1/ea.
16203345 914M 18" x 2000' 1/ea.
16203348 916M 24" x 2000' 1/ea.

Foodservice Film - Rolls/Circles/Boards



A. REYNOLDS® FOODSERVICE FILM PACTIV REYNOLDS

Anti-fog with excellent clarity, brilliance and cling in the best dispenser. Built-in locking tabs hold cutter blade and lid firmly in place. High impact inserts help protect film and allows for easier turning.

17309000	900	12" x 1000', Clear	1/r.l.
17309100	910	12" x 2000', Clear	1/r.l.
16203141	904	18" x 1000', Clear	1/r.l.
17309140	914	18" x 2000', Clear	1/r.l.
17309150	915	18" x 3000', Clear	1/r.l.
17309160	916	24" x 2000', Clear	1/r.l.



B. REYNOLDS® FOODSERVICE FILM SLIDE CUTTER PACTIV REYNOLDS

Slide cutter for use with film rolls.

17300404	SC18	18"	24/cs.
----------	------	-----	--------



C. OMNIFILM™ FOODSERVICE FILM PLIANT CORPORATION

Gives you one premium stretch film for meats and perishable packaging so you can operate with less expense, more inventory turns, and better cash flow. Great for hand wrap, semi-automatic, and automatic wrapping equipment. Conforms to irregular shapes. Forms tight, wrinkle-free packages. Excellent heat-seal properties. Fine clarity and sparkle.

14206836	15X400070GA	15" x 4000', 70 GA, Clear	1/ea.
14201418	126601	18" x 5000'	1/ea.
14206837	19X400070GA	19" x 4000', 70 GA, Clear	1/ea.



D. REVOLUTION® MEAT & PRODUCE WRAPPING FILM PLIANT CORPORATION

A sustainable solution for all fresh perishable packaging. For improved yield and higher performance at lower costs. Thinner gauge, high performance film. Utilizing can lower packaging expenses while maintaining outstanding performance characteristics for both in-store manual wrap stations and high-speed automation.

14200023	821110	15" x 7000'	1/ea.
14200024	821112	17" x 7000'	1/ea.
14200021	821113	18" x 7000', 50 GA, Clear	1/ea.



CIRCLES/BOARDS

E. BAKER'S CIRCLES HONEYMOON PAPER PRODUCTS

Baker's Circles

Field proven to inhibit the transfer of oil and grease from the icing or cake to the board. Your presentation stays cleaner longer without those unsightly grease marks left when other coatings or non-coated board are used. A scalloped line allows for an upscale product presentation, facilitating the removal of another costly item... the doily.

38471080	CIR809S	9", White	200/cs.
38476141	CIR810S	10", White	50/cs.
38470077	CIR810S	10", White	250/cs.

Corrugated Circles/Pads

Laminated in gold, it sets your bakery party apart from everyone else.

38470608	CIR608S200	8", Scalloped, Gold, Circle	200/cs.
38470610	CIR609S200	9", Gold, Circle	200/cs.
38470064	PAD609S	1/8 Sheet, 9 3/4" x 7", Scalloped, Gold, Pad	150/cs.
38470057	PAD614S	1/4 Sheet, 14" x 10", Scalloped, Gold, Pad	75/cs.

Snobrite Pizza Circle

Perfect circles, clean and precisely cut.

38470103	CIR1161	16"	100/cs.
----------	---------	-----	---------

Corrugated Pad

Corrugated baker's pad.

38470030	PAD814DC	1/4 Sheet, 14" x 10", White, Die Cut	75/cs.
----------	----------	--------------------------------------	--------



Circles/Boards/Pan Liners

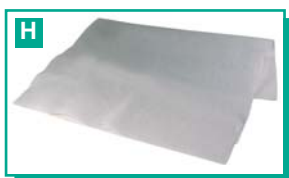
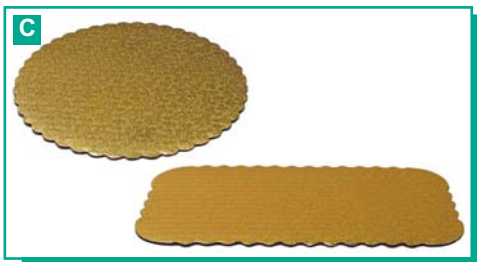
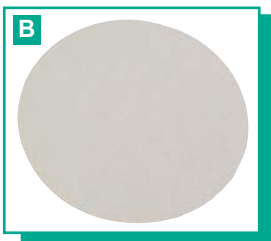

A. SAVADAY® MOLDED FIBER CIRCLE HUHTAMAKI

Molded fiber items are molded paper fiber formed into uniquely shaped products to assure strength and rigidity in foodservice operations. For baked items the pie plates provide the right size for all your needs. Plus, molded fiber items accept excess fats from baked goods, keeping pies flaky.

15301028 10228 10", Impair 250/cs.

B. CAKE PAD MENASHA PACKAGING

Uncoated corrugated cake pad.

54213012 WT12 12", White 250/cs.

C. GOLDEN LACE™ CAKE CIRCLES/BOARDS MENASHA PACKAGING

Golden Lace™ combines the warmth and richness of gold, the softness of lace, and the beauty of scalloped edges to create a sophisticated, luxurious presentation.

54210210 GOL9 9", Gold 200/cs.

54216566 GOL50 10³/₈" x 5³/₈", Gold 200/cs.

54210204 GOLQ 1/4 Sheet, 13³/₄" x 9³/₄", Gold 100/cs.

54210205 GOLH 1/2 Sheet, 18³/₄" x 13³/₄", Gold 50/cs.

D. CAKE CIRCLES PACTIV

Features a clean, bright appearance. Extremely lightweight. Sturdy white foam. Circular ribs provide easy handling and the strength to support heavy loads.

16201384 60725 7¹/₄" 1000/cs.

16201340 60800 8" 500/cs.

16201493 60900 9" 500/cs.

16201342 60900Z 9", Scalloped Edge 500/cs.

E. CAKE BOARDS SMURFIT - STONE CONTAINER

Corrugated cake boards.

19606906 105908 1/2 Sheet, 18³/₄" x 13³/₄" x 6", White, Scalloped 50/cs.

19606903 102900 Full Sheet, 25¹/₂" x 17¹/₂" x 13", White, Scalloped 50/cs.

F. BAKER'S CIRCLE/PAD SOUTHERN CONTAINER CORPORATION

Die-cut corrugated.

68260004 16BWCC 16", White, Circle 125/cs.

68260005 PAD823 23³/₄" x 18³/₄", White, Pad 50/cs.

PAN LINERS

G. PRIME SOURCE® BAKERY PAN LINERS PRIME SOURCE®

A premium coated parchment pan liner ideal for reuse. Kosher and Pareve for year-round use.

75003991 75003991 16³/₈" x 24³/₈", 25# 1000/cs.

H. PRIME SOURCE® PAN LINERS PRIME SOURCE®

Quillon-treated kraft pan liner.

75003990 75003990 16³/₈" x 24³/₈", 25#, Brown 1000/cs.

I. ECOCRAFT® ARTISAN PAN LINERS BAGCRAFT/PAPERCON

EcoCraft® 2-Star pan liners with improved release are unbleached, compostable and biodegradable. Kosher certified (Star K).

10900963 030025 16³/₈" x 24³/₈", Unbleached 2-Star 1000/cs.

Pan Liners/Cake Decorating



A. ECOCRAFT® BAKE 'N' REUSE™

PAN LINERS BAGCRAFT/PAPERCON

Comparable to a silicone greaseproof baking sheet but without the chromium. It is manufactured from chlorine-free pulp and approved for standard waste disposal. The liners have excellent heat retention for baking of high-moisture items and can be used at temperatures up to 425°F. 100% recycled.

16400180 030010 16³/₈" x 24³/₈", Medium Temperature 1000/cs.



B. PAN LINERS

BAGCRAFT/PAPERCON

For all baking and candy needs: cookies, bagels, bread, cakes, danish, rolls, croissants, candies. For more even baking with no scorching. Easy release silicone or quilon treated eliminates pan greasing and cleanup. Reusable for economy. Save warehouse space, disposal costs. Environmentally compatible. Made from 100% biodegradable cellulose fibers, high wet strength for durability. All natural parchment will not contaminate and is completely odorless and tasteless, allowing baked goods and candies to retain their original flavor. Hard pinhole-free surface resists grease, water and oven browning. Convenient 1000 sheet box dispenser. FDA approved and suitable for Kosher foods.

10902700 479668 10" x 16", 27# 1000/cs.

16400003 030005 12¹/₈" x 16³/₈", 255Q, Quillon 2000/cs.



C. PARCHMENT SHEETS

BAGCRAFT/PAPERCON

Plain vegetable parchment.

16404013 031121 12" x 12", 27VP12X12, 27# 1000/cs.



D. BAK-O-MATIC® PREMIUM PAN LINERS

GEORGIA-PACIFIC

Kosher parchment. 16³/₈" x 24³/₈".

15007910 35S Blue Label, Parchment Silicone Coated 1000/cs.

15002001 24Q Green Label, Parchment Quilon Coated 1000/cs.

15000362 27SGP Orange Label, Silicone Coated, Greaseproof 1000/cs.

15002711 27S Yellow Label, Parchment Silicone Coated 1000/cs.



E. DIXIE® GREASEPROOF PAN LINERS

GEORGIA-PACIFIC

Economical release treated single use pan liners for one-time baking use in moderate oven conditions. Certified Kosher and Pareve for Passover use when marked with the Star-K symbol.

15002485 LO10U 16³/₈" x 24³/₈", Unbleached 1000/cs.

15002484 LO10 16³/₈" x 24³/₈", White 1000/cs.



F. HANDI-SIZE SINGLE USE PAN LINERS

GEORGIA-PACIFIC

Greaseproof pan liners. Quilon coated. Kosher.

15002002 HS1000 12³/₁₆" x 16³/₈", White 1000/cs.

G. QBAKE™ PLUS PAN LINERS

MCNAIRN PACKAGING

Quilon coated greaseproof pan liners.

46839551 019551 16³/₈" x 24³/₈" 1000/cs.



CAKE DECORATING

H. DISPOSABLE PIPING BAGS

POLY NOVA INDUSTRIES

Eliminate the costly cleaning procedure of canvas bags. Reduce the risk of bacterial contamination, as new bags are used every day. Perforation enhances quick and simple separation of single bags on a roll. Minimized friction on the inner surface enables smooth flow of the filling. Maximized friction on the outer surface for a steady grip.

060700025 7090533 21" 100/cs.



Baking Cups/Tissue & Butcher/Steak Paper



FOODSERVICE WRAPS & PROCESSING

BAKING CUPS

A. BAKING CUPS GEORGIA-PACIFIC

Kosher baking cups.

150073605	15CX	2" x 1 ¹ / ₄ " x 4 ¹ / ₂ ", White	500/bx.
15007360	15CX	2" x 1 ¹ / ₄ " x 4 ¹ / ₂ ", White	10000/cs.
15000903	20CX	2" x 1 ³ / ₈ " x 4 ³ / ₄ ", White	10000/cs.
15007914	30EX	2 ¹ / ₄ " x 1 ⁷ / ₈ " x 6", White	10000/cs.

B. FLUTED PAN LINERS GEORGIA-PACIFIC

Kosher, dry wax treated.

15000822	60BL	7" x 2 ⁷ / ₈ " x 2 ¹ / ₄ ", Oblong, White	2000/cs.
-----------------	------	---	----------

C. BAKERY LINERS PACTIV REYNOLDS

Round fluted layer liners.

14900076	FC7750X1075	8" x 1 ¹ / ₂ ", White	1000/cs.
-----------------	-------------	---	----------

TISSUE PAPER

D. INTERFOLDED DRY WAX TISSUE BAGCRAFT/PAPERCON

Use for quick, sanitary pick-up and handling of goods from counter to customer or use to separate baked goods. Economical dry waxed paper resists grease and water. Lightweight flexibility protects delicate donuts or sturdy bagels. Convenient interfolded pop-up tissue dispensers.

10908000	010006	6" x 10 ³ / ₄ ", TF6	10000/cs.
16401008	010008	8" x 10 ³ / ₄ ", TF8	10000/cs.
16401012	010012	12" x 10 ³ / ₄ ", TF12	6000/cs.
16401033	010015	15" x 10 ³ / ₄ ", TF15	6000/cs.

E. TISSUE PAC® BAKERY TISSUE GEORGIA-PACIFIC

Lightweight, dry waxed tissue interfolded for pop-up convenience. Used for handling baked goods and other food applications without touching the product.

15005810	T6	6" x 10 ³ / ₄ ", 1000 ct., White	10000/cs.
15005812	T12	12" x 10 ³ / ₄ ", 1000 ct., White	6000/cs.

F. MENU PAC MENU TISSUE PAC PAPER

Bakery tissue paper sheets.

52751214	CTW011212	12" x 12", White	10/1000/cs.
-----------------	-----------	------------------	-------------

BUTCHER/STEAK PAPER

G. PRIME SOURCE® PAPER ROLLS PRIME SOURCE®

Highweight paper for extra strength.

Butcher Paper

75003916	75003916	15" x 1000', 40#, White	1/r.
75003901	75003901	15" x 1100', 50#, White	1/r.
75003911	75003911	15" x 1300', 40#, White	1/r.
75003917	75003917	18" x 1000', 40#, White	1/r.
75003902	75003902	18" x 1100', 50#, White	1/r.
75003912	75003912	18" x 1300', 40#, White	1/r.
75003918	75003918	24" x 1000', 40#, White	1/r.
75003903	75003903	24" x 1100', 50#, White	1/r.
75003904	75003904	30" x 1100', 50#, White	1/r.
75003905	75003905	36" x 1100', 50#, White	1/r.
75003914	75003914	36" x 1300', 40#, White	1/r.

Butcher/Steak & Freezer Paper



A. PRIME SOURCE® PAPER ROLLS (CONT.) PRIME SOURCE®

Food Wrap			
75003921	75003921	12" x 1000', 40#, White	1/rl.
75003923	75003923	15" x 1000', 40#, White	1/rl.
75003925	75003925	18" x 1000', 40#, White	1/rl.
75003927	75003927	24" x 1000', 40#, White	1/rl.
75003929	75003929	30" x 1000', 40#, White	1/rl.
75003931	75003931	36" x 1000', 40#, White	1/rl.
75003933	75003933	48" x 1000', 40#, White	1/rl.



B. FRESHLOC BUTCHER PAPER BAGCRAFT/PAPERCON

Mediumweight white poly coated freezer paper. FDA, USDA approved.

16405018	135018	18" x 1000', SF18, 40#, White	1/rl.
----------	--------	-------------------------------	-------

C. STEAK PAPER BAGCRAFT/PAPERCON

Designed to keep meat juices and bloom locked. Durable, high quality paper.

16401912	101912	9" x 12", Green, Sheets	1000/cs.
16400833	106103	10" x 30", Peach, Sheets	1000/cs.



D. BUTCHER PAPER ROLLS GORDON PAPER

Gordon Paper offers a complete line of food service packaging papers suitable for processors, grocery chains, independent retailers, and delis. All of our grocery and market papers carry USDA certification and are approved for food contact. Our high quality brands are instantly recognized as industry leaders assuring maximum protection every time for the foods wrapped and guaranteed reliability for customers who utilize them in process applications.

35620040	15900BUTCHER40	15" x 900', 40#, White	1/ea.
35620003	15BUTCHER	15" x 1000', 12.5#, White	1/ea.
35621800	18900BUTCHER40	18" x 900', 40#, White	1/ea.



E. STEAK PAPER GORDON PAPER

Helps maintain the blush on fresh meat by locking in flavored juices. Strong, water-resistant properties prevent soaking through. Ideal for long-term, clean display.

35620230	0912BLACK	9" x 12", Black	1000/cs.
35620235	0912WHITE	9" x 12", White	100/cs.
35620217	1014BLACK	10" x 14", Black	1000/cs.
35620215	1014PEACH	10" x 14", Peach	1000/cs.
35620210	1030GREEN	10" x 30", Green	1000/cs.
35620212	1030PEACH	10" x 30", Peach	1000/cs.



F. TARPON® BUTCHER PAPER ROLL GORDON PAPER

Tarpon® butcher paper is a clean, 40#, bright white paper with high size and excellent formation to resist blood, oil and moisture penetration. Used extensively in grocery stores for wrapping fresh foods and deli items for customers. It can also be used to cover display cases at night to keep them clean and to make store and window signs.

35620546	24TARPON40	24", 40#	1/ea.
----------	------------	----------	-------



FREEZER PAPER

G. FRESHGARD® LOXOL® FREEZER PAPER ROLLS GEORGIA-PACIFIC

Polyethylene coated freezer paper. Average protection, six to nine months.

15000798	FG15	15" x 1100', White	1/rl.
15000797	FG18	18" x 1100', White	1/rl.
15000819	FG24	24" x 1100', White	1/rl.



Freezer Paper/Paper Wraps & Liners



A. KOLD-LOK® FREEZER PAPER GEORGIA-PACIFIC

Lightweight freezer paper for short term (3-6 months) storage and grocery carry-out. The unique base paper, poly coating and added plasticizer provides easy handling and protection against freezer burn.

15002995	<i>KL15</i>	15" x 1100', White	1/r.
15001621	<i>18SHCUTS</i>	18" x 1000', Meat, Fresh Cuts/Safe Handling Design	1/r.
15001610	<i>18CATCH</i>	18" x 1000', Seafood, Fresh Catch/Safe Handling Design	1/r.
15003100	<i>KL18</i>	18" x 1100', White	1/r.
15000024	<i>KL24</i>	24" x 1100', White	1/r.



B. SUPER LOXOL® FREEZER PAPER GEORGIA-PACIFIC

Heavyweight freezer paper for long term protection (12-15 months), storage and grocery carry-out. The unique base paper, poly coating, and added plasticizer provides easy handling and protection against freezer burn.

15005510	<i>SUPLOX18</i>	18" x 1000', White	1/r.
-----------------	-----------------	--------------------	------



C. HI-VALU DELI PAPER HI-VALU

Interfolded dry wax sheets.

73000030	<i>73000030</i>	6" x 10 ³ / ₄ ", Midget	6000/cs.
73000026	<i>73000026</i>	7 ¹ / ₂ " x 10 ³ / ₄ ", Junior	6000/cs.
73000027	<i>73000027</i>	10" x 10 ³ / ₄ ", Senior	6000/cs.
73000028	<i>73000028</i>	12" x 10 ³ / ₄ ", Master	6000/cs.
73000029	<i>73000029</i>	15" x 10 ³ / ₄ ", Junior	6000/cs.



D. BASKET LINERS BAGCRAFT/PAPERCON

Economical, microwavable, grease resistant basket liner sheets.

10907700	<i>057700</i>	12" x 12", Red Check	5000/cs.
-----------------	---------------	----------------------	----------

E. BASKET LINERS BAGCRAFT/PAPERCON

Poly wax paper basket liners coated over ink.

10900398	<i>300398</i>	12" x 10 ¹ / ₂ ", Red Check	2000/cs.
-----------------	---------------	---	----------



F. DRY WAX SANDWICH WRAPS & BASKET LINERS BAGCRAFT/PAPERCON

Provides wet strength and moderate moisture and grease resistance. Affordable option for basic dry food wrapping applications. Multiple-colored check designs available for easy identification.

10900508	<i>300317</i>	12" x 12", 1000 ct., Big Red Check	2000/cs.
-----------------	---------------	------------------------------------	----------

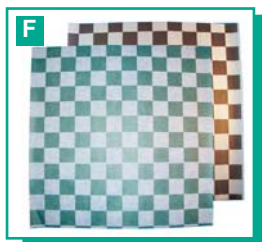

G. DRY WAX SHEETS BAGCRAFT/PAPERCON

Dry waxed paper for wrapping all types of foods. Makes an excellent basket liner, food prep or portion control divider. High wet strength keeps paper intact in all types of applications. Grease and moisture resistant to help ensure product freshness and appearance. Easy release for both fresh and frozen foods. Excellent temperature retention for wrapping hot or cold foods. Convenient pop-up dispenser boxes. FDA approved.

16400610	<i>011006</i>	6" x 10 ³ / ₄ ", QF6, Regular	6000/cs.
16407411	<i>012006</i>	6" x 10 ³ / ₄ ", WF6, Heavyweight	6000/cs.
16400049	<i>011008</i>	8" x 10 ³ / ₄ ", QF8, Regular	6000/cs.
16402008	<i>012008</i>	8" x 10 ³ / ₄ ", WF8, Heavyweight	6000/cs.
16401010	<i>011010</i>	10" x 10 ³ / ₄ ", QF10, Regular	6000/cs.
16407410	<i>012010</i>	10" x 10 ³ / ₄ ", WF10, Heavyweight	6000/cs.
16400039	<i>011012</i>	12" x 10 ³ / ₄ ", QF12, Regular	6000/cs.
16402012	<i>012012</i>	12" x 10 ³ / ₄ ", WF12, Heavyweight	6000/cs.
16409015	<i>011015</i>	15" x 10 ³ / ₄ ", QF15, Regular	6000/cs.
16407415	<i>012015</i>	15" x 10 ³ / ₄ ", WF15, Heavyweight	6000/cs.



Paper Wraps & Liners



A. EASY WRAP GREASE RESISTANT PAPER WRAP & LINERS

BAGCRAFT/PAPERCON

Excellent, flexible protection for hoagies, deli and most cold sandwich products. Grease and stain resistant protection. Excellent moisture barrier.

16404512	057012	12" x 12", EW1212, White	5000/cs.
16401212	057412	12" x 12", EWY1212, Yellow	5000/cs.
16400008	057014	14" x 14", EW1414, White	4000/cs.
16400007	057015	15" x 16", EW1516, White	3000/cs.



B. ECO-CRAFT® INTERFOLDED SHEETS

BAGCRAFT/PAPERCON

Excellent moisture barrier with soy wax blend. Quick sanitary pick-up and handling. Separates assorted baked and deli goods. Easy release fresh or frozen.

16401001	010001	6" x 10 ³ / ₄ ", Natural Kraft	10000/cs.
16401608	016008	8" x 10 ³ / ₄ ", Natural Kraft	6000/cs.
16401601	016010	10" x 10 ³ / ₄ ", Natural Kraft	6000/cs.
16406012	016012	12" x 10 ³ / ₄ ", Natural Kraft	6000/cs.



C. SANDWICH TISSUE

BAGCRAFT/PAPERCON

Lightweight with excellent wet strength.

16409121	059121	12" x 12", White	10000/cs.
----------	--------	------------------	-----------

D. SANDWICH WRAP

BAGCRAFT/PAPERCON

Dry wax sandwich wrap.

16404012	054012	12" x 12", SW1212, White	5000/cs.
----------	--------	--------------------------	----------



E. GLENVALE® INTERFOLDED DELI PAPER

GEORGIA-PACIFIC

All purpose, standard weight, dry waxed deli paper for food handling needs.

15000810	G8	8" x 10 ³ / ₄ ", 500 ct., White	6000/cs.
15001915	G10	10" x 10 ³ / ₄ ", 500 ct., White	6000/cs.
15001210	G12	12" x 10 ³ / ₄ ", 500 ct., White	6000/cs.
15009650	G15	15" x 10 ³ / ₄ ", 500 ct., White	6000/cs.



F. MENU® TISSUE SANDWICH WRAP

GEORGIA-PACIFIC

Versatile untreated tissue paper for lightweight food handling duty.

15000491	862491	12" x 12", White	10000/cs.
----------	--------	------------------	-----------



G. QUIK-RAP® SANDWICH PAPER

GEORGIA-PACIFIC

Economical grease resistant sheets can be used as a basket liner and low cost sandwich wrap. Resists soak-through of product juices and condiments. Non-dry waxed. Microwavable. Will not crack under heat. FDA approved sheets. Allows for attractive custom printing.

15009415	891258	12" x 12", White	5000/cs.
15000515	891254	14" x 14", White	4000/cs.
15005008	891255	15" x 16", White	3000/cs.



H. QUILT WRAP SANDWICH PAPER

GEORGIA-PACIFIC

Laminated. Maximizes heat retention, provides superior moisture control and grease absorption, and improves sandwich appearance. Keeps foods from becoming soggy. Food doesn't stick to wrap, causing less mess and food waste.

15000432	LQ1212TOMA	12" x 12", Tomato	1000/cs.
15001614	LQ1416PL	14" x 16", White	2/500/cs.



Paper Wraps & Liners/Patty Paper/Case Liners



FOODSERVICE WRAPS & PROCESSING



A. RITE WRAP INTERFOLDED DELI PAPER GEORGIA-PACIFIC

Dry waxed deli paper stays folded, absorbs liquids and keeps food fresh. Wet strength added to hold up in moist conditions. Interfolded in attractive dispensing boxes. Absorbs excess grease and oil while acting as a sanitary barrier for food.

15009645	<i>RW66</i>	6" x 10 ³ / ₄ ", White, 500 ct.	6000/cs.
15007000	<i>RW86</i>	8" x 10 ³ / ₄ ", White, 500 ct.	6000/cs.
15000017	<i>RW106</i>	10" x 10 ³ / ₄ ", White, 500 ct.	6000/cs.
15001305	<i>RW126</i>	12" x 10 ³ / ₄ ", White, 500 ct.	6000/cs.
15007227	<i>RW156</i>	15" x 10 ³ / ₄ ", White, 500 ct.	6000/cs.

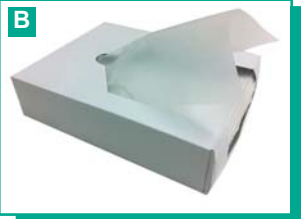

B. TRU-TARE SCALE SHEETS INTEPLAST CORPORATION

Pop-up scale tare sheets.

03600913	<i>4603056</i>	9" x 12", 2 ¹ / ₂ MIL	4000/cs.
03600912	<i>912TRU</i>	9" x 12"	4000/cs.



C. ECO PAC™ INTERFOLDED DRY WAX PAPER SHEETS MARCAL PAPER MILLS

Pop-up, waxed paper sheets have added wet strength for improved performance. Useful as basket-liners and sandwich wrappers. 100% microwaveable. Biodegradable and compostable. Packaging contains 35% post-consumer content and 100% total recovered content.

15705292	<i>5292</i>	10" x 10 ³ / ₄ ", 15/17#, Senior	6000/cs.
-----------------	-------------	--	----------



PATTY PAPER

D. ECO-CRAFT® DELI WRAP BAGCRAFT/PAPERCON

Grease-resistant multi-purpose sandwich wrap/basket liner. Hot or cold applications and microwaveable. Easy-to-eat convenience for single portions.

16400897	<i>300897</i>	12" x 12", Natural Kraft	5000/cs.
16400898	<i>300898</i>	15" x 16", Natural Kraft	3000/cs.



E. DISPENS-A-WAX DELI PATTY PAPER GEORGIA-PACIFIC

Standard grade, dry waxed deli patty paper sheets for food interleaving or as a pick-up sheet.

15006528	<i>434</i>	4 ³ / ₄ " x 5", White	24000/cs.
15001526	<i>801200</i>	6" x 6", White	10000/cs.

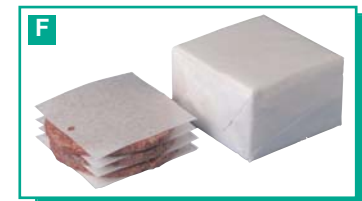

F. PATTY PAPER GEORGIA-PACIFIC

Patty paper roll for interleaving, storing and handling meats and cheeses.

15006520	<i>WR5659</i>	4 ¹ / ₂ " x 4 ¹ / ₂ ", 777 ct., White, 1-Hole Drilled	14000/cs.
15006508	<i>WR58</i>	5" x 5", 777 ct., White, 1-Hole Drilled	14000/cs.

CASE LINERS

G. GRIP LINERS CONWED PLASTICS

Produced with a soft, bubble-foam construction that provides great cushioning and protection. Grip Liner also offers a dry but tacky surface finish that enables slanted displays without slippage of liner or product.

16003660	<i>0588BK</i>	36" x 62", Black	1/ea.
16003661	<i>0588GN</i>	36" x 62", Green	1/ea.

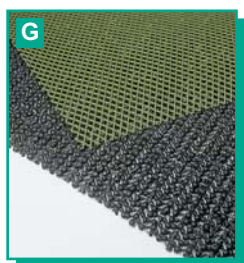

H. STANDARD CASE LINER CONWED PLASTICS

Standard case liner is soft, pliable and more economical than alternative liners. These durable nets can be easily washed and reused. Case liner traps debris so it won't color drainage systems. You can create attractive, maintenance free displays in produce, meat, seafood, dairy and deli departments.

16006335	<i>0577RE</i>	30" x 74", Red	1/ea.
-----------------	---------------	----------------	-------

Case Liners/Labeling/Foam/Barrier Trays



A. CELLU LINER™ MEAT/DAIRY CASE LINERS SEALED AIR

These four-ply case liners are the most effective way to reduce odor and bacteria and enhance appearance in meat, poultry and dairy cases.

18000296	<i>100069681</i>	30" x 250", Black	1/ea.
18000154	<i>100069636</i>	30" x 250", White	1/rl.



LABELING

B. MONARCH® 1110® ONE LINE LABEL GUN AVERY DENNISON

Single line, max 8 characters. Disposable porous roller. Just squeeze, release and apply.

47653562	<i>111002</i>	Label Size 19mm x 10mm, 6 Positions (Bold)	1/ea.
-----------------	---------------	--	-------



C. SCALE LABELS ITW LABELS/HOBART

Hobart Ultima 2000 Series scale labels.

38360039	<i>39121</i>	2 1/4" x 3 1/2", Blank w/Yellow Tab, Hobart UWU350 DA	11500/cs.
-----------------	--------------	---	-----------

Hobart Quantum Series scale labels.

38360041	<i>39163</i>	4 1/2" x 2 1/4", Blank, w/Perf., Hobart QWU450 Quantum	11200/cs.
-----------------	--------------	--	-----------

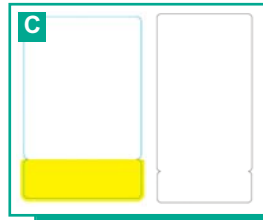

FOAM/BARRIER TRAYS/LIDS

D. TRAYS COMMODORE PLASTICS

Durable polystyrene foam construction.

A-Tray Padded Trays

Well in the bottom of the tray that directs excess liquids into an absorbent proprietary pad.

The pad prevents sticking to the meat or fish. Keeps meats, poultry, and fish fresh.

59660169	<i>AT17LDHK</i>	4 5/8" x 8 5/8" x 3/4", 17H, Black	500/cs.
59660145	<i>AT2HK</i>	5 3/4" x 8 1/4" x 1", 2H, Black	400/cs.
59660142	<i>AT20SHK</i>	6 1/8" x 8 3/4" x 1 1/4", 20SH, Black	500/cs.
59660164	<i>AT4HK</i>	9 1/4" x 6 5/8" x 1 3/8", 4H, Black	400/cs.
59660137	<i>AT9YELLOW</i>	9 1/4" x 11 3/4" x 1 1/2", Yellow	500/cs.
59660166	<i>AT9HK</i>	9 1/4" x 12 1/4" x 1 1/2", 9H, Black	250/cs.
59660230	<i>AT9HR</i>	9 1/4" x 12 1/4" x 1 1/2", 9H, Rose	250/cs.
59660235	<i>AT10SHR</i>	10 3/4" x 5 3/4" x 1 1/4", 10SH, Rose	500/cs.
59660163	<i>AT8HK</i>	10 1/2" x 8 1/4" x 1 1/2", 8H, Black	400/cs.
Meat Trays			
59661816	<i>MT8HW</i>	10 1/2" x 8 1/4" x 1 1/2", 8H, White	400/cs.



E. FOAM TRAYS PACTIV

Supermarket trays provide the right display for your products.

Deep Series Meat Trays

16200401	<i>TF1002P</i>	8" x 5 3/4" x 1 2/5", 2P, White	400/cs.
16201090	<i>TF3002P</i>	8" x 5 3/4" x 1 2/5", 2P, Yellow	400/cs.
16200427	<i>TFB0020</i>	8 13/64" x 5 13/64" x 45/64", 2, Black	500/cs.
16200663	<i>TF40020</i>	8 13/64" x 5 13/64" x 45/64", 2, Blue	500/cs.
16200428	<i>TF90020</i>	8 13/64" x 5 13/64" x 45/64", 2, Rose	500/cs.
16200548	<i>TF10020</i>	8 13/64" x 5 13/64" x 45/64", 2, White	500/cs.
16200424	<i>TF30020</i>	8 13/64" x 5 13/64" x 45/64", 2, Yellow	500/cs.
16200623	<i>TFB04D1</i>	9 1/2" x 7" x 1 1/4", 4D, Black	500/cs.
16200470	<i>TF904D1</i>	9 1/2" x 7" x 1 1/4", 4D, Rose	500/cs.
16200682	<i>TF104D1</i>	9 1/2" x 7" x 1 1/4", 4D, White	500/cs.
16200466	<i>TF304D1</i>	9 1/2" x 7" x 1 1/4", 4D, Yellow	500/cs.
16201218	<i>TF120K0</i>	12" x 8 3/4" x 2 13/32", 20K, White	100/cs.





Foam/Barrier Trays

FOODSERVICE WRAPS & PROCESSING



A. FOAM TRAYS (CONT.)

PACTIV

Family Pack Series Meat Trays

16200922	TFB004H	9 ¹ / ₄ " x 7 ¹ / ₄ " x 1 ¹ / ₄ ", 4H, Black	400/cs.
16201153	TF9004H	9 ¹ / ₄ " x 7 ¹ / ₄ " x 1 ¹ / ₄ ", 4H, Rose	400/cs.
16201287	TF3004H	9 ¹ / ₄ " x 7 ¹ / ₄ " x 1 ¹ / ₄ ", 4H, Yellow	400/cs.
16200058	TF004HW	9 ¹ / ₂ " x 7" x 1 ¹ / ₄ ", 4D, White	400/cs.
16201290	TF4008H	10 ³⁹ / ₆₄ " x 8 ⁵ / ₁₆ " x 1 ¹³ / ₆₄ ", 8H, Blue	400/cs.
16200198	TF9008H	10 ³⁹ / ₆₄ " x 8 ⁵ / ₁₆ " x 1 ¹³ / ₆₄ ", 8H, Rose	400/cs.
16201284	TF1008H	10 ³⁹ / ₆₄ " x 8 ⁵ / ₁₆ " x 1 ¹³ / ₆₄ ", 8H, White	400/cs.
16200437	TF3008H	10 ³⁹ / ₆₄ " x 8 ⁵ / ₁₆ " x 1 ¹³ / ₆₄ ", 8H, Yellow	400/cs.
16200844	TFB009H	11 ²⁹ / ₃₂ " x 9 ²⁹ / ₃₂ " x 1 ¹³ / ₆₄ ", 9H, Black	250/cs.
16201168	TF9009H	11 ²⁹ / ₃₂ " x 9 ²⁹ / ₃₂ " x 1 ¹³ / ₆₄ ", 9H, Rose	250/cs.
16207047	TF1009H	11 ²⁹ / ₃₂ " x 9 ²⁹ / ₃₂ " x 1 ¹³ / ₆₄ ", 9H, White	250/cs.
16201160	TF3009H	11 ²⁹ / ₃₂ " x 9 ²⁹ / ₃₂ " x 1 ¹³ / ₆₄ ", 9H, Yellow	250/cs.
16200091	TF11216	12 ¹ / ₂ " x 16 ¹ / ₈ " x 3/4", 1216, White	100/cs.
16201525	TFB25SH	14 ²⁹ / ₃₂ " x 8" x 1", 25SH, Black	250/cs.
16201573	TF925SH	14 ²⁹ / ₃₂ " x 8" x 1", 25SH, Rose	250/cs.
16201865	TF125SH	14 ²⁹ / ₃₂ " x 8" x 1", 25SH, White	250/cs.
16201231	TF325SH	14 ²⁹ / ₃₂ " x 8" x 1", 25SH, Yellow	250/cs.

S Series Meat Trays

16207050	TFB01S0	5 ¹³ / ₆₄ " x 5 ¹³ / ₆₄ " x 39/64", 1S, Black	1000/cs.
16209001	TF101S0	5 ¹³ / ₆₄ " x 5 ¹³ / ₆₄ " x 39/64", 1S, White	1000/cs.
16200540	TFB02S0	8 ¹³ / ₆₄ " x 5 ⁴⁵ / ₆₄ " x 39/64", 2S, Black	500/cs.
16200689	TF402S0	8 ¹³ / ₆₄ " x 5 ⁴⁵ / ₆₄ " x 39/64", 2S, Blue	500/cs.
16201409	TF902S0	8 ¹³ / ₆₄ " x 5 ⁴⁵ / ₆₄ " x 39/64", 2S, Rose	500/cs.
16200681	TF102S0	8 ¹³ / ₆₄ " x 5 ⁴⁵ / ₆₄ " x 39/64", 2S, White	500/cs.
16200463	TF302S0	8 ¹³ / ₆₄ " x 5 ⁴⁵ / ₆₄ " x 39/64", 2S, Yellow	500/cs.
16201212	TF417S0	8 ¹ / ₂ " x 4 ⁵ / ₈ " x 5/8", 17S, Blue	8/125/cs.
16201213	TF917S0	8 ¹ / ₂ " x 4 ⁵ / ₈ " x 5/8", 17S, Rose	1000/cs.
16200688	TF117S0	8 ¹ / ₂ " x 4 ⁵ / ₈ " x 5/8", 17S, White	1000/cs.
16201237	TFB20S0	8 ⁴⁵ / ₆₄ " x 6 ¹³ / ₆₄ " x 39/64", 20S, Black	500/cs.
16201224	TF920S0	8 ⁴⁵ / ₆₄ " x 6 ¹³ / ₆₄ " x 39/64", 20S, Rose	500/cs.
16201222	TF120S0	8 ⁴⁵ / ₆₄ " x 6 ¹³ / ₆₄ " x 39/64", 20S, White	500/cs.
16200487	TFB04S0	9 ¹ / ₈ " x 7 ¹ / ₈ " x 39/64", 4S, Black	500/cs.
16200480	TF404S0	9 ¹ / ₈ " x 7 ¹ / ₈ " x 39/64", 4S, Blue	500/cs.
16200483	TF904S0	9 ¹ / ₈ " x 7 ¹ / ₈ " x 39/64", 4S, Rose	500/cs.
16200683	TF104S0	9 ¹ / ₈ " x 7 ¹ / ₈ " x 39/64", 4S, White	500/cs.
16200476	TF304S0	9 ¹ / ₈ " x 7 ¹ / ₈ " x 39/64", 4S, Yellow	500/cs.
16207088	TFB08S0	10 ¹ / ₂ " x 8 ¹ / ₄ " x 1 ¹ / ₅ ", 8S, Black	500/cs.
16200503	TF908S0	10 ¹ / ₂ " x 8 ¹ / ₄ " x 1 ¹ / ₅ ", 8S, Rose	500/cs.
16200684	TF108S0	10 ¹ / ₂ " x 8 ¹ / ₄ " x 1 ¹ / ₅ ", 8S, White	500/cs.
16200670	TFB10S0	10 ³ / ₄ " x 5 ³ / ₄ " x 39/64", 10S, Black	500/cs.
16201195	TF410S0	10 ³ / ₄ " x 5 ³ / ₄ " x 39/64", 10S, Blue	500/cs.
16200042	TF910S0	10 ³ / ₄ " x 5 ³ / ₄ " x 39/64", 10S, Rose	500/cs.
16200685	TF110S0	10 ³ / ₄ " x 5 ³ / ₄ " x 39/64", 10S, White	500/cs.
16201194	TF310S0	10 ³ / ₄ " x 5 ³ / ₄ " x 39/64", 10S, Yellow	500/cs.
16201201	TF113S0	10 ¹³ / ₁₆ " x 4 ³⁹ / ₆₄ " x 39/64", 13S, White	500/cs.
16200542	TFB12S0	11 ¹ / ₄ " x 9 ¹ / ₄ " x 6/10", 12S, Black	250/cs.
16200669	TF912S0	11 ¹ / ₄ " x 9 ¹ / ₄ " x 6/10", 12S, Rose	250/cs.
16200259	TF112S0	11 ¹ / ₄ " x 9 ¹ / ₄ " x 6/10", 12S, White	2/125/cs.
16200667	TF312S0	11 ¹ / ₄ " x 9 ¹ / ₄ " x 6/10", 12S, Yellow	250/cs.
16201208	TF916S0	11 ⁴⁵ / ₆₄ " x 7 ⁵ / ₁₆ " x 39/64", 16S, Rose	250/cs.
16200687	TF116S0	11 ⁴⁵ / ₆₄ " x 7 ⁵ / ₁₆ " x 39/64", 16S, White	250/cs.
16200500	TFB07S0	14 ⁴⁵ / ₆₄ " x 5 ⁴⁵ / ₆₄ " x 21/32", 7S, Black	250/cs.
16200494	TF107S0	14 ⁴⁵ / ₆₄ " x 5 ⁴⁵ / ₆₄ " x 21/32", 7S, White	250/cs.

Produce Trays

16200517	TP20015	8 ¹³ / ₃₂ " x 3 ²⁹ / ₃₂ " x 1", 3, Green	4/250/cs.
16200696	TP20020	8 ¹³ / ₆₄ " x 5 ¹³ / ₆₄ " x 45/64", 2, Green	500/cs.

Foam/Barrier Trays/Lids



A. FOAM TRAYS (CONT.)

PACTIV

Food Trays

16200680	51Y101P	5 ¹ / ₄ " x 5 ¹ / ₄ " x 1", 1, White	1000/cs.
16200807	TF902P	8" x 5 ³ / ₄ " x 1 ² / ₅ "	400/cs.
16204002	51P102	8 ³ / ₆₄ " x 5 ¹⁹ / ₆₄ " x 45/64", 2, White	500/cs.
16200569	51P917S	8 ¹ / ₂ " x 4 ⁵ / ₈ " x 5/8", 17S, Black	1000/cs.
16200664	51P404D	9 ¹ / ₂ " x 7" x 1 ¹ / ₄ ", 4D, Blue	500/cs.
16200768	51A909L	9 ⁷ / ₈ " x 11 ⁷ / ₈ " x 1", 9L, Black	200/cs.
16200708	51P109L	9 ⁷ / ₈ " x 11 ⁷ / ₈ " x 1", 9L, White	200/cs.
16203090	51P309L	9 ⁷ / ₈ " x 11 ⁷ / ₈ " x 1", 9L, Yellow	200/cs.
16201899	51P91014	10" x 14" x 1", 10X14, Black	100/cs.
16201896	51P51014	10" x 14" x 1", 10X14, Rose	100/cs.
16200758	51P11014	10" x 14" x 1", 10X14, White	100/cs.
16200926	TF908PH	10 ¹ / ₂ " x 8 ¹ / ₄ " x 1 ¹ / ₅ ", 8PH, Black	400/cs.
16202026	51P910P	10 ³ / ₄ " x 5 ¹ / ₂ " x 11 ¹ / ₄ ", 10P, Black	400/cs.
16201189	XTR1010P	10 ³ / ₄ " x 5 ¹ / ₂ " x 1 ¹ / ₄ ", 10P, White	400/cs.
16201187	XTRB010P	10 ⁷ / ₈ " x 5 ⁷ / ₈ " x 1 ¹ / ₃₂ ", 10P, Black, Heavy	400/cs.
16202616	52P9148D	14" x 8" x 1 ⁷ / ₁₆ ", 148D, Black	100/cs.



B. CLEARVIEW™ TRAYMATES™ DOME LIDS

PACTIV

Dome fits over foam meat tray and provides a great looking, cost effective package.

16202378	C18S2S0	Fits 2 & 2S, 8 ¹ / ₅ " x 5 ⁷ / ₁₀ " x 1 ¹ / ₂ "	252/cs.
16200588	C18S17S	Fits 17S, 8 ³ / ₁₀ " x 4 ⁴ / ₅ " x 1 ¹ / ₂ "	250/cs.
16200626	C18D17S	Fits 17S, 8 ³ / ₁₀ " x 4 ⁴ / ₅ " x 2 ¹ / ₁₀ "	250/cs.

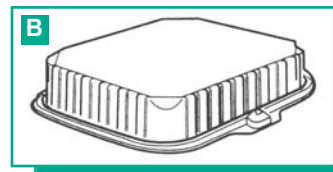

C. CRYOVAC® FOAM TRAYS

SEALED AIR

Cryovac® foam trays provide superior strength, durability, and variety. We deliver consistent quality in weight, color, count, and machinability.

18000565	TS2C	8 ¹ / ₄ " x 5 ³ / ₄ " x 1", 2, Charcoal	500/cs.
18000529	TS2W	8 ¹ / ₄ " x 5 ³ / ₄ " x 1", 2, White	500/cs.



D. CRYOVAC® NATURETRAY™ FOAM TRAYS

SEALED AIR

A line of environmentally sensitive foam trays for use in the packaging of fresh beef, pork, poultry and fish. Created with NatureWorks® biopolymer, the Cryovac® NatureTRAY™ package is made entirely from an annually renewable resource, and delivers all of the benefits of traditional polystyrene foam trays. Available in a range of sizes for both supermarket and processor grade applications. Made from plants, a 100% annually renewable domestic resource. Compostable in industrial compost facilities, where available. Requires significantly less fossil fuel resources than traditional petroleum-based polystyrene it replaces. Processor trays have exceptional machinability to withstand the rigors of automated packaging operations.

18000010	100460411	8 ⁹ / ₁₀ " x 5 ⁴ / ₅ " x 1", White	500/cs.
18000630	100460412	8 ¹ / ₂ " x 4 ¹ / ₂ " x 3/5", 17S, White	1000/cs.
18000018	100460399	9 ³ / ₁₀ " x 6 ⁴ / ₅ " x 1 ³ / ₁₀ ", 4P, White	500/cs.
18000056	100460415	10 ⁴ / ₅ " x 5 ¹ / ₂ " x 1", 10P, White	500/cs.
18000058	100460414	10 ⁴ / ₅ " x 5 ⁹ / ₁₀ " x 3/5", 10S, White	500/cs.





Tray Pads

TRAY PADS

FOODSERVICE WRAPS & PROCESSING



A. ABSORBENT PADS

SEALED AIR

Cryovac® NaturePAD™

A line of environmentally sensitive absorbents for use in the packaging of fresh beef, pork, poultry and fish. NaturePAD™ absorbents deliver all the benefits of traditional absorbent pads but are made from renewable products that come from nature. Created with NatureWorks® biopolymer, Cryovac NaturePAD™ absorbents are made entirely from plants, an annually renewable resource. Available in three absorbencies: 40 grams, 75 grams, 150 grams. Made from plants, a 100% annually renewable domestic resource. Maintains integrity and absorbency. Compostable in industrial compost facilities.

18000053 100471265 5" x 7", 75g, White 1000/cs.

Dri-Loc®

One-way valves and sealed edges keep product fresher, longer. Reduces costly rewraps and product downgrades. Keeps display cases cleaner. Greater customer satisfaction; packages stay drier and more attractive. Pads absorb juices only from the bottom of the pad and do not dry out the meat. Meat retains fresh, juicy appearance longer.

18005950 AC25WW 3 1/8" x 6", 25 - 30g Absorbency, White/White 2000/cs.

18000050 AC40BKW 4" x 7", 40 - 45g Absorbency, Black/White 2000/cs.

18005960 AC40RW 4" x 7", 40 - 45g Absorbency, Rose/White 2000/cs.

18000110 65816 4" x 7", 40 - 45g Absorbency, White/White 2000/cs.

18000111 AC40WW 4" x 7", 40 - 45g Absorbency, White/White, Compression Pack 2000/cs.

18005956 AC40YW 4" x 7", 40 - 45g Absorbency, Yellow/White 2000/cs.

18005964 AC50BKW 4 3/4" x 7", 50 - 55g Absorbency, Black/White 2000/cs.

18005966 65834 4 3/4" x 7", 50 - 55g Absorbency, Rose/White 2000/cs.

18000124 AC50WW 4 3/4" x 7", 50 - 55g Absorbency, White/White 2000/cs.

18000160 AC90WW 5" x 6", 90 - 95g Absorbency, White/White 1000/cs.

Premier Dri-Loc®

Specially designed for maximum retention, Premier Dri-Loc® absorbent pads are ideal for a variety of meat, fish, and poultry applications. Looks better, lasts longer in demanding retail applications. Innovative poly top masks purge, hiding visible juices in the pad. Utilize superabsorbent polymers for improved moisture retention. Improved moisture absorption even for packages displayed in the shingled position. Same exceptional seal strength found on all Dri-Loc® products. Contain the same industry-leading quality virgin pulp absorbent fluff. No reclaimed fiber materials.

18005901 100296607C 4" x 6", Black, Compression Pack 3000/cs.

18005900 100296598C 4" x 6", White, Compression Pack 3000/cs.

Product Index

Index	
2	Dryer Sheets
100	Dryer Carpet
100	Dust Mop Frames
75	Dust Mop Handles
102	Dust Mops
77	Dust Pans
2	Dusters
71	Dusters - Quilted
100	Dusting Brush
148	100
148	100
148	100
101	Electronic Organizer
100	Electronic Organizer
102-104	Exam Gloves
2	Extension Pole
2	Extension Pole - Change

A

Air Fresheners	.88 JS-95 JS
All Purpose Cleaners	.12 GS-25 GS, 41 JS-49 JS
Aluminum Foil	.357 FS-359 FS
Aluminum Food Containers	.323 FS-326 FS
Amenities, Hotel	.120 JS
Apparel	.165 JS-174 JS
Aprons	.171 JS, 172 JS
Automotive	
Brushes	.186 JS
Cleaners	.30 GS, 99 JS

B

Baby Wipes	.163 JS
Bag Dispenser Rack	.354 FS
Bags	
Caddy	.235 JS
Foil	.349 FS
Paper	.21 GS, 22 GS, 343 FS-349 FS
Piping	.365 FS
Plastic	.346 FS, 349 FS-356 FS
Baker's Circles	.363 FS, 364 FS
Bakery Boxes	.21 GS, 338 FS
Bakery Containers	.324 FS, 325 FS, 337 FS-342 FS
Bakery/Bread Bags	.347 FS-351 FS
Baking Cups	.366 FS
Bar Glass Sanitizers	.67 JS-69 JS
Bar Soaps	.101 JS
Barrel Sacks	.343 FS
Barrier Trays	.371 FS-373 FS
Basket Liners	.368 FS
Bath Mats	.163 JS
Batteries	.213 JS
Beard Guards	.171 JS
Beverage Napkins	.293 FS
Beverage/Drink Carriers	.334 FS
Blade Replacements	.292 FS
Bleach	.71 JS, 72 JS
Block Whiteners	.63 JS
Body/Hair Shampoo	.112 JS, 113 JS, 120 JS
Bonnets, Carpet	.242 JS, 243 JS
Bouffant Caps	.170 JS
Bowl Brushes/Mops	.186 JS
Bowl Cleaners	.27 GS, 82 JS-85 JS
Boxes	
Bakery	.21 GS, 338 FS
Bussing/Utility	.287 FS
Braces, Broom	.191 JS
Bread/Bakery Bags	.347 FS-351 FS
Broom	
Braces	.191 JS
Handles	.192 JS
Brooms	.187 JS-191 JS

Brushes	
Automotive	.186 JS
Bowl	.186 JS
Counter	.185 JS
Floor	.187 JS
Scrub	.185 JS
Bubble Wrap	.291 FS
Bucket/Wringer Mop Combos	.208 JS, 209 JS
Buckets	
Food	.329 FS
Mop	.37 GS, 207 JS, 208 JS
Utility	.212 JS
Bussing/Utility Box	.287 FS
Butcher Paper	.366 FS, 367 FS

C

Caddy Bags	.235 JS
Caddy, Maid	.235 JS
Cake	
Circles	.363 FS, 364 FS
Containers	.338 FS-340 FS
Decorating	.365 FS
Cake/Bakery Pads	.363 FS, 364 FS
Can Liners	.37 GS, 38 GS, 217 JS-224 JS
Caps/Hats	.171 JS
Carpet	
Bonnets	.242 JS, 243 JS
Cleaners	.29 GS, 129 JS
Stain Removers	.130 JS, 131 JS
Carry-Out Containers	.330 FS
Carton Sealing Tape	.290 FS
Carts	.214 JS, 215 JS
Case Liners	.370 FS, 371 FS
Cash Register	
Ribbon	.289 FS
Rolls	.290 FS
Caterware	.335 FS-337 FS
Caution Cone	.210 JS
Centerpull	
Towel Dispensers	.159 JS, 160 JS
Towels	.32 GS, 33 GS, 148 JS, 149 JS
C-Fold	
Towels	.33 GS, 34 GS, 151 JS, 152 JS
Towel Dispensers	.160 JS
Chafing Fuel	.285 FS
Chef Hats	.171 JS
Chemical Wipes	.179 JS, 180 JS
Cigarette Waste Collectors	.237 JS
Cleaners	
All Purpose	.12 GS-25 GS, 41 JS-49 JS
Automotive	.30 GS, 99 JS
Bowl	.27 GS, 82 JS-85 JS
Carpet	.129 JS
Concrete	.123 JS

Electronics	.58 JS
Floor	.27 GS, 28 GS, 121 JS-125 JS
Freezer	.53 JS
Fryer	.63 JS
Glass	.25 GS, 26 GS, 55 JS-58 JS
HVAC	.99 JS
Neutral	.124 JS, 125 JS
Oven & Grill	.62 JS, 63 JS
Restroom	.26 GS, 27 GS, 78 JS-80 JS
Tile	.80 JS-82 JS
Tile & Stone	.123 JS
Wood	.28 GS, 44 JS, 59 JS, 122 JS
Cleaning Carts	.214 JS
Cleaning/Maintenance Gloves	.174 JS
Cocktail Napkins	.293 FS
Coffee	.286 FS
Coffee/Tea Filters	.287 FS
Concrete Cleaners	.123 JS
Containers	
Food	.16 GS-21 GS, 301 FS-332 FS, .337 FS-342 FS
Recycling	.38 GS-40 GS, 232 JS-235 JS
Trash	.38 GS, 39 GS, 225 JS-232 JS
Corn Dog Sticks	.271 FS
Counter Brushes	.185 JS
Cube Trucks	.237 JS
Cup	
Buddy	.260 FS
Dispensers	.269 FS
Insert	.269 FS
Lids	.255 FS-268 FS
Cupcake/Muffin Containers	.341 FS, 342 FS
Cups	
Baking	.366 FS
Foam	.265 FS-268 FS
Hot Beverage	.12 GS, 257 FS-259 FS, 266 FS, 267 FS
Paper	.255 FS-259 FS, 268 FS, 269 FS
Plastic	.11 GS, 12 GS, 260 FS-264 FS
Portion/Souffle	.18 GS, 19 GS, 326 FS-328 FS
Specialty	.268 FS, 269 FS
Cut-End Mops	.202 JS-205 JS
Cutlery	.10 GS, 11 GS, 274 FS-285 FS
Cutlery Kits	.283 FS-285 FS
Cutters	.292 FS
D	
Deck & Yacht Mops	.205 JS
Defoamers	.131 JS
Degreasers	.25 GS, 49 JS-53 JS
Deli	
Bags	.347 FS-350 FS, 354 FS-356 FS
Paper	.368 FS
Wrap	.22 GS
Delimiters	.69 JS, 80 JS-82 JS
Deodorants	.27 GS, 88 JS-95 JS

Index	
2	Dye Sheets
126	Dye Carpet
128	Dye Mop Frames
76	Dye Mop Handles
53	Dye Mop Footmats
162	Dye Mop
116	Dye Pans
2	Dusters
129	Dusting Brushes
148	150
158	160
160	161
162	163
164	165
166	167
168	169
170	171
172	173
174	175
176	177
178	179
180	181
182	183
184	185
186	187
188	189
190	191
192	193
194	195
196	197
198	199
200	201
202	203
204	205
206	207
208	209
210	211
212	213
214	215
216	217
218	219
220	221
222	223
224	225
226	227
228	229
230	231
232	233
234	235
236	237
238	239
240	241
242	243
244	245
246	247
248	249
250	251
252	253
254	255
256	257
258	259
260	261
262	263
264	265
266	267
268	269
270	271
272	273
274	275
276	277
278	279
280	281
282	283
284	285
286	287
288	289
290	291
292	293
294	295
296	297
298	299
300	301
302	303
304	305
306	307
308	309
310	311
312	313
314	315
316	317
318	319
320	321
322	323
324	325
326	327
328	329
330	331
332	333
334	335
336	337
338	339
340	341
342	343
344	345
346	347
348	349
350	351
352	353
354	355
356	357
358	359
360	361
362	363
364	365
366	367
368	369
370	371
372	373
374	375
376	377
378	379
380	381
382	383
384	385
386	387
388	389
390	391
392	393
394	395
396	397
398	399
400	401
402	403
404	405
406	407
408	409
410	411
412	413
414	415
416	417
418	419
420	421
422	423
424	425
426	427
428	429
430	431
432	433
434	435
436	437
438	439
440	441
442	443
444	445
446	447
448	449
450	451
452	453
454	455
456	457
458	459
460	461
462	463
464	465
466	467
468	469
470	471
472	473
474	475
476	477
478	479
480	481
482	483
484	485
486	487
488	489
490	491
492	493
494	495
496	497
498	499
500	501
502	503
504	505
506	507
508	509
510	511
512	513
514	515
516	517
518	519
520	521
522	523
524	525
526	527
528	529
530	531
532	533
534	535
536	537
538	539
540	541
542	543
544	545
546	547
548	549
550	551
552	553
554	555
556	557
558	559
560	561
562	563
564	565
566	567
568	569
570	571
572	573
574	575
576	577
578	579
580	581
582	583
584	585
586	587
588	589
590	591
592	593
594	595
596	597
598	599
600	601
602	603
604	605
606	607
608	609
610	611
612	613
614	615
616	617
618	619
620	621
622	623
624	625
626	627
628	629
630	631
632	633
634	635
636	637
638	639
640	641
642	643
644	645
646	647
648	649
650	651
652	653
654	655
656	657
658	659
660	661
662	663
664	665
666	667
668	669
670	671
672	673
674	675
676	677
678	679
680	681
682	683
684	685
686	687
688	689
690	691
692	693
694	695
696	697
698	699
700	701
702	703
704	705
706	707
708	709
710	711
712	713
714	715
716	717
718	719
720	721
722	723
724	725
726	727
728	729
730	731
732	733
734	735
736	737
738	739
740	741
742	743
744	745
746	747
748	749
750	751
752	753
754	755
756	757
758	759
760	761
762	763
764	765
766	767
768	769
770	771
772	773
774	775
776	777
778	779
780	781
782	783
784	785
786	787
788	789
790	791
792	793
794	795
796	797
798	799
800	801
802	803
804	805
806	807
808	809
810	811
812	813
814	815
816	817
818	819
820	821
822	823
824	825
826	827
828	829
830	831
832	833
834	835
836	837
838	839
840	841
842	843
844	845
846	847
848	849
850	851
852	853
854	855
856	857
858	859
860	861
862	863
864	865
866	867
868	869
870	871
872	873
874	875
876	877
878	879
880	881
882	883
884	885
886	887
888	889
890	891
892	893
894	895
896	897
898	899
900	901
902	903
904	905
906	907
908	909
910	911
912	913
914	915
916	917
918	919
920	921
922	923
924	925
926	927
928	929
930	931
932	933
934	935
936	937
938	939
940	941
942	943
944	945
946	947
948	949
950	951
952	953
954	955
956	957
958	959
960	961
962	963
964	965
966	967
968	969
970	971
972	973
974	975
976	977
978	979
980	981
982	983
984	985
986	987
988	989
990	991
992	993
994	995
996	997
998	999
1000	1001

Product Index

Detergents

Dishwashing	.26 GS, 64 JS-67 JS, 68 JS
Laundry	.70 JS, 71 JS
Diaper Changing Station	.163 JS
Dinner Napkins	.15 GS, 16 GS, 296 FS-298 FS
Dinnerware	
Foam	.251 FS-254 FS
Paper	.7 GS-9 GS, 245 FS-249 FS
PLA	.10 GS, 251 FS
Plastic	.250 FS, 251 FS
Dishmachine Delimers	.69 JS
Dishwashing Detergents	.26 GS, 64 JS-67 JS, 68 JS
Disinfectants	.26 GS, 74 JS-78 JS
Dispenser Napkins	.13 GS-15 GS, 294 FS-296 FS
Dispenser Rack, Bag	.354 FS
Dispensers	
Blade	.292 FS
Centerpull Towel	.159 JS, 160 JS
C-Fold/Multifold Towel	.160 JS
Cup	.269 FS
Napkin	.298 FS, 299 FS
Pump	.212 JS
Roll Towel	.157 JS-159 JS
Singlefold Towel	.160 JS
Soap	.117 JS-120 JS
Toilet Seat Cover	.163 JS
Toilet Tissue	.139 JS-141 JS
Disposable Cutlery	.274 FS-285 FS
Dollies	.299 FS
Dollies	.236 JS
Drain Maintainers	.27 GS, 85 JS, 86 JS
Drink/Beverage Carriers	.334 FS
Drum Pump	.212 JS
Dust Mask	.171 JS
Dust Mopping	
Frames	.36 GS, 199 JS
Handle	.200 JS
Mops	.198 JS, 199 JS
Treatment	.122 JS
Dust Pans	.193 JS
Dusting Tools	.35 GS, 36 GS, 193 JS, 194 JS

E

Electronics Cleaners	.58 JS
Equipment Cart	.215 JS

F

Fabric Softeners	.73 JS
Facial Tissue	.31 GS, 141 JS-144 JS
Feminine Hygiene	.35 GS, 161 JS
Film Rolls	.360 FS-363 FS
Film Sheets	.359 FS, 360 FS
Filter Powder	.286 FS
Filters	
Coffee/Tea	.287 FS
Grease	.286 FS
Water	.287 FS

Floor

Brushes	.187 JS
Cleaners	.27 GS, 28 GS, 53 JS, 121 JS-125 JS
Finish	.29 GS, 126 JS, 127 JS
Finish Applicators	.209 JS
Matting	.40 GS, 244 JS
Pads	.241 JS, 242 JS
Signs	.210 JS
Squeegees	.211 JS
Strippers	.28 GS, 123 JS, 124 JS
Sweepers	.244 JS
Sweeps	.190 JS, 191 JS

Foam

Cups	.265 FS-268 FS
Dinnerware	.251 FS-254 FS
Food Containers	.320 FS-323 FS
Trays	.371 FS-373 FS

Foaming Soaps

	.107 JS-110 JS
--	----------------

Foil

Bags	.349 FS
Sheets/Rolls	.357 FS-359 FS

Folded Towels

	.33 GS-35 GS
--	--------------

Food Containers

Aluminum	.323 FS-326 FS
Foam	.320 FS-323 FS
Paper	.16 GS, GS 17, 301 FS-305 FS, .328 FS-332 FS, 337 FS, 338 FS
Plastic	.17 GS-19 GS, 305 FS-320 FS, .326 FS-239 FS, 338 FS-342 FS

Food Trays

	.19 GS-21, 331 FS-334 FS
--	--------------------------

Food/Utility Bags

	.351 FS-353 FS
--	----------------

Foodservice

Film	.359 FS-363 FS
Tissue	.366 FS
Towels	.175 JS-17

Product Index

Index	
2	Dye Sheets
100	Dye Carpet
100	Dye Mop Frames
75	Dye Mop Handles
102	Dye Mop Frames
102	Dye Mop
77	Dye Pad
2	Dyeers
71	Dyeers Quilts
100	Dyeing Brush
148	100
146	146
155	151
101	Electronics Cleaner
100	Electronic Mop
102	Exam Gloves
2	Exhaust Pad
2	Exhaust Cleaner

Liquid Wax	.285 FS
Liquor Bags	.344 FS
Looped-End Mops	.200 JS-202 JS
Lotion	.116 JS
Lotion Soaps	.105 JS-107 JS
Lubricants	.98 JS
Luncheon Napkins	.15 GS, 294 FS, 296, FS

M

Maid Caddy	.235 JS
Maintenance/Cleaning Gloves	.174 JS
Mask, Dust	.171 JS
Masking Tape	.291 FS
Mats, Bath	.163 JS
Matting	.40 GS, 244 JS
Measuring Cup	.287 FS
Meat Trays	.371 FS-373 FS
Medicated Soaps	.102 JS-105 JS
Merchandise Bags	.345 FS
Metal Polish	.61 JS
Microfiber Cleaning	.35 GS-37 GS, 194 JS-197 JS
Moist Towelettes	.299 FS
Mopping	
Bowl Mops	.186 JS
Bucket/Wringer Combos	.208 JS, 209 JS
Buckets	.37 GS, 207 JS, 208 JS
Cut-End Mops	.202 JS-205 JS
Deck & Yacht Mops	.205 JS
Dust Mops	.198 JS, 199 JS
Handles	.205 JS, 206 JS
Looped-End Mops	.200 JS-202 JS
Microfiber Mops	.36 GS, 37 GS
Sponge Mops	.206 JS, 207 JS
Wringers	.37 GS, 207 JS
Muffin/Cupcake Containers	.341 FS, 342 FS
Multifold	
Towels	.34 GS, 35, GS, 153 JS-155 JS
Towel Dispensers	.160 JS
Multi-Use Paper	.290 FS

N

Napkin	
Bands	.298 FS
Dispensers	.298 FS, 299 FS
Napkins	
Beverage	.13 GS, 293 FS
Dinner	.15 GS, 16 GS, 296 FS-298 FS
Dispenser	.13 GS-15 GS, 294 FS-296 FS
Luncheon	.15 GS, 294 FS, 296, FS
Sanitary	.161 JS
Neutral Floor Cleaners	.124 JS, 125 JS
Nitrile Gloves	.169 JS

O

Oven & Grill Cleaners	.62 JS, 63 JS
Oven Mitt	.173 JS

P

Pad Holders	.183 JS
Pads	
Cake/Bakery	.363 FS, 364 FS
Floor	.241 JS, 242 JS
Grill	.184 JS, 185 JS
Knee	.174 JS
Scouring	.182 JS, 183 JS
Soap	.184 JS
Steel Wool	.184 JS
Tray	.374 FS
Pallet Wrap	.291 FS, 292 FS
Pan Liners	.21 GS, 364 FS, 365 FS
Paper	
Bags	.21 GS, 22 GS, 343 FS-349 FS
Butcher	.366 FS, 367 FS
Cups	.255 FS-259 FS, 268 FS, 269 FS
Cutter	.292 FS
Deli	.368 FS
Dinnerware	.7 GS-9 GS, 245 FS-249 FS
Food Containers	.16 GS, 16 GS, 301 FS-305 FS, .328 FS-332 FS, 337 FS, 338 FS
Freezer	.367 FS, 368 FS
Multi-Use	.290 FS
Patty	.370 FS
Printer/Copy	.290 FS
Register	.290 FS
Steak	.366 FS, 367 FS
Waxed	.366 FS, 368 FS-370 FS
Patty Paper	.370 FS
Pie Containers	.340 FS, 341 FS
Piping Bags	.365 FS
Pizza Packaging	.331 FS
PLA Dinnerware	.10 GS, 251 FS
Placemats	.299 FS
Plant Sleeve	.354 FS
Plastic	
Bags	.346 FS, 349 FS-356 FS
Cups	.11 GS, 12 GS, 260 FS-264 FS
Dinnerware	.250 FS, 251 FS
Food Containers	.17 GS-19 GS, 305 FS-320 FS, .326 FS-239 FS, 338 FS-342 FS
Platform Trucks	.237 JS, 238 JS
Polish	
Furniture	.58 JS-60 JS
Metal	.61 JS
Poly Gloves	.167 JS, 168 JS
Popcorn	
Bags	.348 FS
Containers	.329 FS
Portion/Souffle Cups	.18 GS, 19 GS, 326 FS-328 FS
Pot Scrubbers	.184 JS
Powdered Soaps	.101 JS
Printer/Copy Paper	.290 FS
Processing Trays	.371 FS-373 FS
Produce Basket	.331 FS
Produce/Roll Bags	.353 FS, 354 FS
Protective Sleeves	.174 JS
Pumps	.212 JS

R

Rack Cover	.256 FS
Rags	.176 JS
Razor Blades	.292 FS
Receptacles, Sanitary Napkin	.162 JS
Reclosable Bags	.355 FS, 356 FS
Recycling Containers	.38 GS-40 GS, 232 JS-235 JS
Restroom Cleaners	.26 GS, 27 GS, 78 JS-80 JS
Rinse Additives	.69 JS
Rodent Killers	.98 JS
Roll Towel Dispensers	.157 JS-159 JS
Roll Towels	.31 GS, 32 GS, 144 JS-147 JS
Roll/Produce Bags	.353 FS, 354 FS
Rubber Bands	.290 FS

S

Safety Apparel	.173 JS, 174 JS, 292 FS
Sandwich	
Bags	.22 GS, 347 FS-350 FS, 355 FS
Wraps	.368 FS, 369 FS
Sanitary Napkin Receptacles/Liners	.161 JS, 162 JS
Sanitary Napkins	.161 JS
Sanitizers	
Bar Glass	.67 JS-69 JS
Hand	.23 GS, 113 JS-115 JS
Surface	.54 JS, 69 JS
Warewashing	.69 JS
Scale Labels	.371 FS
School Lunch Trays	.333 FS
Scoop	.287 FS
Scouring	
Gloves	.174 JS
Pads	.182 JS, 183 JS
Scrapers	.211 JS, 288 FS
Screens, Grill	.185 JS
Scrub Brushes	.185 JS
Scrubbers	.184 JS
Seasoning	.286 FS
Serving Utensils	.285 FS
Shampoo	
Body/Hair	.112 JS, 113 JS, 120 JS
Vehicle	.30 GS
Sheets	
Film	.359 FS, 360 FS
Interfolded	.22 GS, 366 FS, 368 FS-370 FS
Shop Towels	.176 JS
Shopping Bags	.21 GS, 345 FS
Signs	.210 JS
Singlefold	
Towel Dispensers	.160 JS
Towels	.156 JS

Product Index

Index	
2	Dye Sheets
136	Dye Carpet
129	Dye Mat
76	Dye Mat Stand
53	Dye Mat Stand
102	Dye Mat Stand
27	Dye Mat Stand
118	Dye Mat Stand
2	Dye Mat Stand
2	Dye Mat Stand
129	Dye Mat Stand
148	Dye Mat Stand
151	Dye Mat Stand
151	Dye Mat Stand
151	Dye Mat Stand
151	Dye Mat Stand
151	Dye Mat Stand
151	Dye Mat Stand
151	Dye Mat Stand
151	Dye Mat Stand

Skewers	271 FS
Sleeves	
Hot Cup	260 FS
Plant	354 FS
Protective	174 JS
Smocks	173 JS
Smoking Urns/Receptacles	236 JS, 237 JS
Soap	
Bar	101 JS
Dispensers	117 JS-120 JS
Foaming	107 JS-110 JS
Industrial	110 JS-112 JS
Lotion	105 JS-107 JS
Medicated	102 JS-105 JS
Pads	184 JS
Powdered	101 JS
Souffle/Portion Cups	18 GS, 19 GS, 326 FS-328 FS
Specialty Cups	268 FS, 269 FS
Spill Station	210 JS
Sponge Mops	206 JS, 207 JS
Sponges	181 JS
Spray Bottles	211 JS, 212 JS
Sprayers	211 JS, 212 JS
Square Edge Sticks	271 FS
Squeegees	211 JS
Stain Removers	
Carpet	29 GS, 130 JS, 131 JS
Laundry	73 JS
Stainless Steel Scrubbers	184 JS
Steak Paper	366 FS, 367 FS
Steamtable Pans	325 FS, 326 FS
Steel Wool Pads	184 JS
Step Stools	213 JS
Stirrers	271 FS, 272 FS
Straws	13 GS, 272 FS-274 FS
Stretch Film	291 FS
String Knit Gloves	173 JS
Strippers, Floor	123 JS, 124 JS
Sweepers, Floor	244 JS
Systems	
Chemical	96 JS
Deodorant	91 JS-95 JS
Dusting	194 JS
Floor Finish	209 JS
Hand Care	120 JS
Microfiber	195 JS-197 JS
T	
Table Covers	16 GS, 300 FS
Tampons	161 JS
Tank Sprayers	212 JS
Tape	290 FS, 291 FS
Tile & Stone Cleaners	123 JS
Tile Cleaners	80 JS-82 JS

Tilt Trucks	237 JS-239 JS
Tissue	
Facial	31 GS, 141 JS-144 JS
Foodservice	366 FS
Paper	366 FS
Toilet	30 GS, 31 GS, 133 JS-139 JS
Toilet	
Blocks	87 JS
Seat Cover Dispensers	163 JS
Seat Covers	35 GS, 162 JS, 163 JS
Tissue	30 GS, 31 GS, 133 JS-139 JS
Tissue Dispensers	139 JS-141 JS
Tongs	285 FS
Tool Holders	213 JS
Toothpicks	271 FS
Tote/T-Shirt Bags	346 FS, 347 FS
Towels	
Centerpull	32 GS, 33 GS, 148 JS, 149 JS
C-Fold	151 JS, 152 JS
Foodservice	175 JS-178 JS
Hand	176 JS
Kitchen	33 GS
Multifold	153 JS-155 JS
Roll	31 GS, 32 GS, 144 JS-147 JS
Shop	176 JS
Singlefold	156 JS
Windshield	156 JS, 157 JS, 175 JS
Trades Cart	215 JS
Trash Containers	38 GS, 39 GS, 225 JS-232 JS
Tray	
Covers	299 FS
Pads	374 FS
Trays	
Caterware	335 FS-337 FS
Foam	371 FS-373 FS
Food	19 GS-21 GS, 331 FS-334 FS
Pizza	20 GS, 331 FS
School Lunch	19 GS, 333 FS
Trigger Sprayers	211 JS, 212 JS
Trucks	237 JS-239 JS
T-Shirt/Tote Bags	22 GS, 346 FS, 347 FS
Tubs, Food	329 FS
Twine	292 FS
Twist Ties	354 FS
U	
Urinal	
Blocks	87 JS
Screens	87 JS, 88 JS
Utility	
Carts	214 JS, 215 JS
Food Bags	351 FS-353 FS
Trucks	238 JS

V	
Vacuum Cleaners	243 JS, 244 JS
Vandal Mark/Graffiti Removers	54 JS, 55 JS
Vehicle Shampoo	30 GS, JS 99
Vinyl Gloves	166 JS, 167 JS
W	
Wall Washer	200 JS
Warewashing Sanitizers	69 JS
Wastebaskets	224 JS, 225 JS
Water Filters	287 FS
Waxed Paper	366 FS, 368 FS-370 FS
Window Squeegees	211 JS
Windshield Towels	156 JS, 157 JS, 175 JS
Wipers	175 JS-178 JS
Wipes	
Baby	163 JS
Chemical	179 JS, 180 JS
Hand/Face	115 JS, 116 JS
Wood Cleaners	28 GS, 44 JS, 59 JS, 122 JS
Work Gloves	173 JS
Wraps, Foodservice	367 FS-370 FS
Wringers, Mop	207 JS
Y	
Yacht & Deck Mops	205 JS