



GRACO

Vac Motor Catalog

Tel: 800-872-4472

Fax: 888-872-4472

www.GRACOMFG.com

VOLTAGE

Graco #	Prior Graco #	Ametek Number	Graco A+ Version	Prior Graco A+ Version	VOLTAGE	Size	Stages	Discharge	Inlet Tube	Picture #
86601190	VM-1	116115-00	NA	NA	24	5.7"	2	Peripheral		# 5
86854670	VM-29	119436-13	86005440	VM29A+	24	5.7"	2	Tangential		# 6
98482060	VM-29B	116157-29	NA	NA	24	5.7"	2	Tangential	1.5"	# 14
98483190	VM-29-A	116157-32	NA	NA	24	5.7"	2	Tangential	1-7/8"	# 8
88083590	VM-43	116764-13	NA	NA	24	5.7"	3	Peripheral Low Noise		# 20
86634360	VM-45	116514-13	NA	NA	24	5.7"	3	Peripheral		# 26
86854550	VM-23	119433-13	86854560	VM23A+	24	5.7"	3	Tangential		# 27
86854780	VM-34	119433-29	86005460	VM34A+	24	5.7"	3	Tangential	1.5"	# 28
86724040	VM-47	117504-13	NA	NA	24	7.2"	2	Tangential		# 9
86854620	VM-27	116158-01	86012210	VM27A+	36	5.7"	2	Tangential		# 1
86854510	VM-2	116156-00	NA	NA	36	5.7"	2	Peripheral		# 16
86607400	VM-20	116158-00	NA	NA	36	5.7"	2	Tangential		# 11
86601200	VM-24	119431-13	NA	NA	36	5.7"	3	Peripheral		# 32
86854650	VM-280	119432-13	86258480	VM280A+	36	5.7"	3	Tangential		# 22
86854720	VM-30	119432-29	86005450	VM30A+	36	5.7"	3	Tangential	1.5"	# 31
86634340	VM-26	116513-32	NA	NA	36	5.7"	3	Tangential	1-7/8"	# 33
86854980	VM-56	117505-13	NA	NA	36	7.2"	2	Tangential		# 12
86623200	VM-42	115419	NA	NA	42	7.5"	3	Peripheral		# 34
86603040	WV-19	116378-00	NA	NA	120	4.2"	2	Thru-Flow		# 13



#88083590



#86854990



Check out photos of all our Vac Motors on pages 11-13

VOLTAGE



#86854820



#86855060



Graco #	Prior Graco #	Ametek Number	Graco A+ Version	Prior Graco A+ Version	VOLTAGE	Size	Stages	Discharge	Inlet Tube	Picture #
86026750	VM-46	116551-50	NA	NA	120	4.8"	2	Peripheral		# 7
86657610	VM-53	119322-00	NA	NA	120	5.1"	1	Thru-Flow		# 2
86855050	VM-8	116325-00	NA	NA	120	5.7"	1	Peripheral		# 4
86854820	VM-4	116883-00	86854910	VM4A+	120	5.7"	2	Thru-Flow		# 15
86634780	VM-51	116311-01	86854910	VM4A+	120	5.7"	2	Thru-Flow		# 10
86855020	VM-7	116336-00	86258410	VM7A+	120	5.7"	2	Peripheral		# 17
86854420	VM-13	116392-00	86202040	VM13A+	120	5.7"	2	Tangential		# 18
98481240	VM-13-A	116392-32	NA	NA	120	5.7"	2	Tangential	1-7/8"	# 19
98481640	VM-13B	116392-29	NA	NA	120	5.7"	2	Tangential	1.5"	# 29
86634760	VM-54	116758-13	NA	NA	120	5.7"	2	Peripheral Low Noise		# 21
86854580	VM-25	116565-13	86258420	VM25A+	120	5.7"	3	Tangential		# 36
86854740	VM-31	116565-29	86258430	VM31A+	120	5.7"	3	Tangential	1.5"	# 35
86854760	VM-33	116764-13	86258450	VM33A+	120	5.7"	3	Peripheral		# 38
86855060	VM-9	115330	NA	NA	120	7.2"	2	Peripheral		# 30
86724030	VM-17	115962	NA	NA	120	7.2"	2	Peripheral		# 23
86854400	VM-11	115334	NA	NA	120	7.2"	2	Tangential		# 24
86854410	VM-12	115937	NA	NA	120	7.2"	2	Tangential		# 25
86854970	VM-55	115923	NA	NA	120	5.7"	2	Thru-Flow		# 41
86854460	VM-14	116103	NA	NA	120	7.2"	3	Tangential		# 37
86620570	VM-28	116118-00	NA	NA	120	7.2"	3	Peripheral		# 39
86686220	VM-10	114787	NA	NA	120	7.5"	3	Peripheral		# 40

SIZE

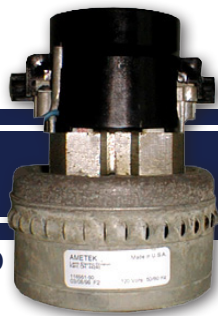

#86026750



#86601190



Check out photos of all our Vac Motors on pages 11-13

Graco Number	Prior	Ametek Number	Graco A+ Version	Prior	SIZE	Stages	Voltage	Discharge	Inlet Tube	Picture #
86603040	WV-19	116378-00	NA	NA	4.2"	2	120	Thru-Flow		# 13
86026750	VM-46	116551-50	NA	NA	4.8"	2	120	Peripheral		# 7
86657610	VM-53	119322-00	NA	NA	5.1"	1	120	Thru-Flow		# 2
86854990	VM-6	116881-50	86258550	VM6A+	5.7"	1	120	Thru-Flow		# 3
86855050	VM-8	116325-00	NA	NA	5.7"	1	120	Peripheral		# 4
86601190	VM-1	116115-00	NA	NA	5.7"	2	24	Peripheral		# 5
86854670	VM-29	119436-13	86005440	VM29A+	5.7"	2	24	Tangential		# 6
98482060	VM-29B	116157-29	NA	NA	5.7"	2	24	Tangential	1.5"	# 14
98483190	VM-29-A	116157-32	NA	NA	5.7"	2	24	Tangential	1-7/8"	# 8
86854620	VM-27	116158-01	86012210	VM27A+	5.7"	2	36	Tangential		# 1
86854510	VM-2	116156-00	NA	NA	5.7"	2	36	Peripheral		# 16
86607400	VM-20	116158-00	NA	NA	5.7"	2	36	Tangential		# 11
86854820	VM-4	116883-00	86854910	VM4A+	5.7"	2	120	Thru-Flow		# 15
86634780	VM-51	116311-01	86854910	VM4A+	5.7"	2	120	Thru-Flow		# 10
86855020	VM-7	116336-00	86258410	VM7A+	5.7"	2	120	Peripheral		# 17
86854420	VM-13	116392-00	86202040	VM13A+	5.7"	2	120	Tangential		# 18
98481240	VM-13-A	116392-32	NA	NA	5.7"	2	120	Tangential	1-7/8"	# 19
98481640	VM-13B	116392-29	NA	NA	5.7"	2	120	Tangential	1.5"	# 29
86854970	VM-55	115923	NA	NA	5.7"	2	120	Thru-Flow		# 41
86634760	VM-54	116758-13	NA	NA	5.7"	2	120	Peripheral Low Noise		# 21

SIZE

Graco Number	Prior	Ametek Number	Graco A+ Version	Prior	SIZE	Stages	Voltage	Discharge	Inlet Tube	Picture #
86634360	VM-45	116514-13	NA	NA	5.7"	3	24	Peripheral		# 26
86854550	VM-23	119433-13	86854560	VM23A+	5.7"	3	24	Tangential		# 27
86854780	VM-34	119433-29	86005460	VM34A+	5.7"	3	24	Tangential	1.5"	# 28
88083590	VM-43	116764-13	NA	NA	5.7"	3	24	Peripheral Low Noise		# 20
86854650	VM-280	119432-13	86258480	VM280A+	5.7"	3	36	Tangential		# 22
86854720	VM-30	119432-29	86005450	VM30A+	5.7"	3	36	Tangential	1.5"	# 31
86601200	VM-24	119431-13	NA	NA	5.7"	3	36	Peripheral		# 32
86634340	VM-26	116513-32	NA	NA	5.7"	3	36	Tangential	1-7/8"	# 33
86854580	VM-25	116565-13	86258420	VM25A+	5.7"	3	120	Tangential		# 36
86854740	VM-31	116565-29	86258430	VM31A+	5.7"	3	120	Tangential	1.5"	# 35
86854760	VM-33	116764-13	86258450	VM33A+	5.7"	3	120	Peripheral		# 38
86724040	VM-47	117504-13	NA	NA	7.2"	2	24	Tangential		# 9
86854980	VM-56	117505-13	NA	NA	7.2"	2	36	Tangential		# 12
86855060	VM-9	115330	NA	NA	7.2"	2	120	Peripheral		# 30
86724030	VM-17	115962	NA	NA	7.2"	2	120	Peripheral		# 23
86854400	VM-11	115334	NA	NA	7.2"	2	120	Tangential		# 24
86854410	VM-12	115937	NA	NA	7.2"	2	120	Tangential		# 25
86854460	VM-14	116103	NA	NA	7.2"	3	120	Tangential		# 37
86620570	VM-28	116118-00	NA	NA	7.2"	3	120	Peripheral		# 39
86623200	VM-42	115419	NA	NA	7.5"	3	42	Peripheral		# 34
86686220	VM-10	114787	NA	NA	7.5"	3	120	Peripheral		# 40



#86634360



#86686220



STAGES

Graco Number	Prior	Ametek Number	Graco A+ Version	Prior	STAGES	Voltage	Size	Discharge	Inlet Tube	Picture #
86657610	VM-53	119322-00	NA	NA	1	120	5.1"	Thru-Flow		# 2
86854990	VM-6	116881-50	86258550	VM6A+	1	120	5.7"	Thru-Flow		# 3
86855050	VM-8	116325-00	NA	NA	1	120	5.7"	Peripheral		# 4
86601190	VM-1	116115-00	NA	NA	2	24	5.7"	Peripheral		# 5
86854670	VM-29	119436-13	86005440	VM29A+	2	24	5.7"	Tangential		# 6
98482060	VM-29B	116157-29	NA	NA	2	24	5.7"	Tangential	1.5"	# 14
98483190	VM-29-A	116157-32	NA	NA	2	24	5.7"	Tangential	1-7/8"	# 8
86724040	VM-47	117504-13	NA	NA	2	24	7.2"	Tangential		# 9
86854620	VM-27	116158-01	86012210	VM27A+	2	36	5.7"	Tangential		# 1
86854510	VM-2	116156-00	NA	NA	2	36	5.7"	Peripheral		# 16
86607400	VM-20	116158-00	NA	NA	2	36	5.7"	Tangential		# 11
86854980	VM-56	117505-13	NA	NA	2	36	7.2"	Tangential		# 12
86603040	WV-19	116378-00	NA	NA	2	120	4.2"	Thru-Flow		# 13
86026750	VM-46	116551-50	NA	NA	2	120	4.8"	Peripheral		# 7
86854820	VM-4	116883-00	86854910	VM4A+	2	120	5.7"	Thru-Flow		# 15
86634780	VM-51	116311-01	86854910	VM4A+	2	120	5.7"	Thru-Flow		# 10
86855020	VM-7	116336-00	86258410	VM7A+	2	120	5.7"	Peripheral		# 17
86854420	VM-13	116392-00	86202040	VM13A+	2	120	5.7"	Tangential		# 18
86854970	VM-55	115923	NA	NA	2	120	5.7"	Thru-Flow		# 41
98481240	VM-13-A	116392-32	NA	NA	2	120	5.7"	Tangential	1-7/8"	# 19
98481640	VM-13B	116392-29	NA	NA	2	120	5.7"	Tangential	1.5"	# 29



#86854670



#86854510



Check out photos of all our Vac Motors on pages 11-13

STAGES



#86724030



#86854650



Graco Number	Prior	Ametek Number	Graco A+ Version	Prior	STAGES	Voltage	Size	Discharge	Inlet Tube	Picture #
86634760	VM-54	116758-13	NA	NA	2	120	5.7"	Peripheral Low Noise		# 21
86855060	VM-9	115330	NA	NA	2	120	7.2"	Peripheral		# 30
86724030	VM-17	115962	NA	NA	2	120	7.2"	Peripheral		# 23
86854400	VM-11	115334	NA	NA	2	120	7.2"	Tangential		# 24
86854410	VM-12	115937	NA	NA	2	120	7.2"	Tangential		# 25
86634360	VM-45	116514-13	NA	NA	3	24	5.7"	Peripheral		# 26
86854550	VM-23	119433-13	86854560	VM23A+	3	24	5.7"	Tangential		# 27
86854780	VM-34	119433-29	86005460	VM34A+	3	24	5.7"	Tangential	1.5"	# 28
88083590	VM-43	116764-13	NA	NA	3	24	5.7"	Peripheral Low Noise		# 20
86854650	VM-280	119432-13	86258480	VM280A+	3	36	5.7"	Tangential		# 22
86854720	VM-30	119432-29	86005450	VM30A+	3	36	5.7"	Tangential	1.5"	# 31
86601200	VM-24	119431-13	NA	NA	3	36	5.7"	Peripheral		# 32
86634340	VM-26	116513-32	NA	NA	3	36	5.7"	Tangential		# 33
86623200	VM-42	115419	NA	NA	3	42	7.5"	Peripheral		# 34
86854760	VM-33	116764-13	86258450	VM33A+	3	120	5.7"	Peripheral		# 38
86854580	VM-25	116565-13	86258420	VM25A+	3	120	5.7"	Tangential		# 36
86854740	VM-31	116565-29	86258430	VM31A+	3	120	5.7"	Tangential	1.5"	# 35
86854460	VM-14	116103	NA	NA	3	120	7.2"	Tangential		# 37
86620570	VM-28	116118-00	NA	NA	3	120	7.2"	Peripheral		# 39
86686220	VM-10	114787	NA	NA	3	120	7.5"	Peripheral		# 40

DISCHARGE



#86601200



#86854760



Check out photos of all our Vac Motors on pages 11-13

Graco Number	Prior	Ametek Number	Graco A+ Version	Prior	DISCHARGE	Size	Stages	Voltage	Inlet Tube	Picture #
86026750	VM-46	116551-50	NA	NA	Peripheral	4.8"	2	120		# 7
86855050	VM-8	116325-00	NA	NA	Peripheral	5.7"	1	120		# 4
86601190	VM-1	116115-00	NA	NA	Peripheral	5.7"	2	24		# 5
86854510	VM-2	116156-00	NA	NA	Peripheral	5.7"	2	36		# 16
86855020	VM-7	116336-00	86258410	VM7A+	Peripheral	5.7"	2	120		# 17
86634360	VM-45	116514-13	NA	NA	Peripheral	5.7"	3	24		# 26
86601200	VM-24	119431-13	NA	NA	Peripheral	5.7"	3	36		# 32
86854760	VM-33	116764-13	86258450	VM33A+	Peripheral	5.7"	3	120		# 38
86855060	VM-9	115330	NA	NA	Peripheral	7.2"	2	120		# 30
86724030	VM-17	115962	NA	NA	Peripheral	7.2"	2	120		# 23
86620570	VM-28	116118-00	NA	NA	Peripheral	7.2"	3	120		# 39
86623200	VM-42	115419	NA	NA	Peripheral	7.5"	3	42		# 34
86686220	VM-10	114787	NA	NA	Peripheral	7.5"	3	120		# 40
86634760	VM-54	116758-13	NA	NA	Peripheral Low Noise	5.7"	2	120		# 21
88083590	VM-43	116764-13	NA	NA	Peripheral Low Noise	5.7"	3	24		# 20
86854670	VM-29	119436-13	86005440	VM29A+	Tangential	5.7"	2	24		# 6
98482060	VM-29B	116157-29	NA	NA	Tangential	5.7"	2	24	1.5"	# 14
98483190	VM-29-A	116157-32	NA	NA	Tangential	5.7"	2	24	1-7/8"	# 8
86854620	VM-27	116158-01	86012210	VM27A+	Tangential	5.7"	2	36		# 1
86607400	VM-20	116158-00	NA	NA	Tangential	5.7"	2	36		# 11

DISCHARGE

Graco Number	Prior	Ametek Number	Graco A+ Version	Prior	DISCHARGE	Size	Stages	Voltage	Inlet Tube	Picture #
86854420	VM-13	116392-00	86202040	VM13A+	Tangential	5.7"	2	120		# 18
98481240	VM-13-A	116392-32	NA	NA	Tangential	5.7"	2	120	1-7/8"	# 19
98481640	VM-13B	116392-29	NA	NA	Tangential	5.7"	2	120	1.5"	# 29
86854550	VM-23	119433-13	86854560	VM23A+	Tangential	5.7"	3	24		# 27
86854780	VM-34	119433-29	86005460	VM34A+	Tangential	5.7"	3	24	1.5"	# 28
86854650	VM-280	119432-13	86258480	VM280A+	Tangential	5.7"	3	36		# 22
86854720	VM-30	119432-29	86005450	VM30A+	Tangential	5.7"	3	36	1.5"	# 31
86634340	VM-26	116513-32	NA	NA	Tangential	5.7"	3	36	1-7/8"	# 33
86854580	VM-25	116565-13	86258420	VM25A+	Tangential	5.7"	3	120		# 36
86854740	VM-31	116565-29	86258430	VM31A+	Tangential	5.7"	3	120	1.5"	# 35
86724040	VM-47	117504-13	NA	NA	Tangential	7.2"	2	24		# 9
86854980	VM-56	117505-13	NA	NA	Tangential	7.2"	2	36		# 12
86854400	VM-11	115334	NA	NA	Tangential	7.2"	2	120		# 24
86854410	VM-12	115937	NA	NA	Tangential	7.2"	2	120		# 25
86854460	VM-14	116103	NA	NA	Tangential	7.2"	3	120		# 37
86603040	WV-19	116378-00	NA	NA	Thru-Flow	4.2"	2	120		# 13
86657610	VM-53	119322-00	NA	NA	Thru-Flow	5.1"	1	120		# 2
86854990	VM-6	116881-50	86258550	VM6A+	Thru-Flow	5.7"	1	120		# 3
86854820	VM-4	116883-00	86854910	VM4A+	Thru-Flow	5.7"	2	120		# 15
86854970	VM-55	115923	NA	NA	Thru-Flow	5.7"	2	120		# 41
86634780	VM-51	116311-01	86854910	VM4A+	Thru-Flow	5.7"	2	120		# 10



#86854420



#86854550



INLET TUBE

Graco Number	Prior	Ametek Number	Graco A+ Version	Prior	INLET TUBE	Discharge	Size	Stages	Voltage	Picture #
98482060	VM-29B	116157-29	NA	NA	1.5"	Tangential	5.7"	2	24	# 14
98481640	VM-13B	116392-29	NA	NA	1.5"	Tangential	5.7"	2	120	# 29
86854780	VM-34	119433-29	86005460	VM34A+	1.5"	Tangential	5.7"	3	24	# 28
86854720	VM-30	119432-29	86005450	VM30A+	1.5"	Tangential	5.7"	3	36	# 31
86854740	VM-31	116565-29	86258430	VM31A+	1.5"	Tangential	5.7"	3	120	# 35
98483190	VM-29-A	116157-32	NA	NA	1-7/8"	Tangential	5.7"	2	24	# 8
98481240	VM-13-A	116392-32	NA	NA	1-7/8"	Tangential	5.7"	2	120	# 19
86634340	VM-26	116513-32	NA	NA	1-7/8"	Tangential	5.7"	3	36	# 33
86026750	VM-46	116551-50	NA	NA		Peripheral	4.8"	2	120	# 7
86855050	VM-8	116325-00	NA	NA		Peripheral	5.7"	1	120	# 4
86601190	VM-1	116115-00	NA	NA		Peripheral	5.7"	2	24	# 5
86854510	VM-2	116156-00	NA	NA		Peripheral	5.7"	2	36	# 16
86855020	VM-7	116336-00	86258410	VM7A+		Peripheral	5.7"	2	120	# 17
86634360	VM-45	116514-13	NA	NA		Peripheral	5.7"	3	24	# 26
86601200	VM-24	119431-13	NA	NA		Peripheral	5.7"	3	36	# 32
86854760	VM-33	116764-13	86258450	VM33A+		Peripheral	5.7"	3	120	# 38
86855060	VM-9	115330	NA	NA		Peripheral	7.2"	2	120	# 30
86724030	VM-17	115962	NA	NA		Peripheral	7.2"	2	120	# 23
86620570	VM-28	116118-00	NA	NA		Peripheral	7.2"	3	120	# 39
86854970	VM-55	115923	NA	NA		Thru-Flow	5.7"	2	120	# 41
86623200	VM-42	115419	NA	NA		Peripheral	7.5"	3	42	# 34



#98482060



#86854780



Check out photos of all our Vac Motors on pages 11-13

INLET TUBE



#86854620



#86854460

Graco Number	Prior	Ametek Number	Graco A+ Version	Prior	INLET TUBE	Discharge	Size	Stages	Voltage	Picture #
86686220	VM-10	114787	NA	NA		Peripheral	7.5"	3	120	# 40
86634760	VM-54	116758-13	NA	NA		Peripheral Low Noise	5.7"	2	120	# 21
88083590	VM-43	116764-13	NA	NA		Peripheral Low Noise	5.7"	3	24	# 20
86854670	VM-29	119436-13	86005440			Tangential	5.7"	2	24	# 6
86854620	VM-27	116158-01	86012210			Tangential	5.7"	2	36	# 1
86607400	VM-20	116158-00	NA	NA		Tangential	5.7"	2	36	# 11
86854420	VM-13	116392-00	86202040			Tangential	5.7"	2	120	# 18
86854550	VM-23	119433-13	86854560			Tangential	5.7"	3	24	# 27
86854650	VM-280	119432-13	86258480			Tangential	5.7"	3	36	# 22
86854580	VM-25	116565-13	86258420			Tangential	5.7"	3	120	# 36
86724040	VM-47	117504-13	NA	NA		Tangential	7.2"	2	24	# 9
86854980	VM-56	117505-13	NA	NA		Tangential	7.2"	2	36	# 12
86854400	VM-11	115334	NA	NA		Tangential	7.2"	2	120	# 24
86854410	VM-12	115937	NA	NA		Tangential	7.2"	2	120	# 25
86854460	VM-14	116103	NA	NA		Tangential	7.2"	3	120	# 37
86603040	WV-19	116378-00	NA	NA		Thru-Flow	4.2"	2	120	# 13
86657610	VM-53	119322-00	NA	NA		Thru-Flow	5.1"	1	120	# 2
86854990	VM-6	116881-50	86258550	VM6A+		Thru-Flow	5.7"	1	120	# 3
86854820	VM-4	116883-00	86854910	VM4A+		Thru-Flow	5.7"	2	120	# 15
86634780	VM-51	116311-01	86854910	VM4A+		Thru-Flow	5.7"	2	120	# 10

VAC MOTOR PHOTOS

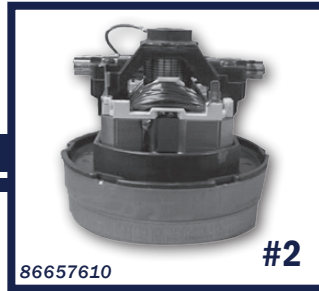

VAC MOTOR PHOTOS



VAC MOTOR PHOTOS





**PARTS AND ACCESSORIES
CATALOG**

Tel: 800-872-4472

Fax: 888-872-4472

www.gracomfg.com



For your convenience and quick reference, we have created the catalog in 2 sections.

The recommended usage of each section is outlined below.

OEM INTERCHANGE

The first section of the catalog is the OEM Interchange. In this section you will find OEM (Original Equipment Manufacturer) part numbers listed to the left, with our recommended Graco part number to the right. If you are familiar with the OEM number of the part needed, this is the quickest way of identifying our Graco number.

GRACO PARTS BY CATEGORY

The second section of the catalog contains a complete listing of Graco parts by product category. In this section you will find detailed descriptions, dimensions, recommended usages, and images of Graco items.

For your convenience there are three features in this section to enable you to find the correct part. First, we have classified the listings under certain categories according to OEM and OEM part number. Second, many categories contain OEM machine reference charts that let you search for parts based on a specific machine.

You will find this helpful in locating items such as batteries, battery chargers or vacuum motors. Finally, we have included alphabetical part listings with detailed descriptions and photo indexes.

At Graco, we're very excited about this new catalog and look forward to your comments and suggestions on how to better serve you!

Visit our website for the most current and complete OEM interchange



PAYMENT TERMS: Approved accounts - Net 30 days from date of invoice.

PAYMENT METHODS: Visa, MasterCard, AMEX, or Open Account with approved credit.

RETURNED CHECKS: There will be a service charge of \$25.00 on each returned check.

FREIGHT: All orders are F.O.B. Blackwood, NJ. Part orders exceeding \$1250.00 (\$500 OnLine) (Excluding batteries, engines) will be shipped freight-free within the continental U.S. or to port of export on foreign shipments. Carrier selection is at the discretion of Graco. (Blue label or red label charges are not included in free freight offer.) All other shipments, excluding back ordered parts, will incur the appropriate freight and handling charges.

Transportation companies are responsible for any shipment damages or discrepancies once shipment has left the Graco warehouse. Carefully inspect all packages before accepting from carrier. Truck shipments require a claim to be submitted directly to the carrier or the claim may not be honored. U.P.S. shipment damage requires inspection of the package by a U.P.S. Inspector. Any concealed damage must be claimed to the carrier within 10 days of receipt. Original shipping container must be kept until claim is reconciled. Please notify Graco of any shortages.

BACK ORDERS: Parts temporarily out of stock will be automatically shipped and invoiced when available unless order indicates "do not ship back order". Appropriate shipping charges will be added to the invoice excluding any additional handling charges.

PRICING: All prices are subject to availability, and may change without notice. Please verify at time of order.

WARRANTY: Graco parts are warranted for 90 days from date of purchase to be free of defects in materials and workmanship, excluding batteries, battery chargers, motors and pumps which carry their own 1 year manufacturer's warranty. Items damaged due to abuse, accidental damage, improper use or lack of care are not covered by warranty. Normal wear parts including cords, rubber items, hoses, and brushes are excluded from warranty. All warranties must have prior authorization by Graco to qualify for reimbursement. All warranty inquiries should be directed to your Customer Service Representative. The foregoing is in lieu of all other warranties, expressed or implied, and constitute Graco's only obligation with respect to parts. Graco assumes no liability for individual or consequential damages.

RETURNS: No return of parts will be accepted without prior approval by Graco. A complete Return Goods Authorization must accompany all returns and can be obtained by contacting your Customer Service Representative. All returned merchandise will be charged a 20% restocking fee unless covered by warranty or shipped in error. Merchandise for return must be filed within 30 days of receipt. Issued returns are only valid for 30 days. After 30 days return authorizations will be voided. Freight charges on all product(s) returned including warranted parts are the responsibility of the customer. All returned merchandise must be sent pre-paid by UPS or FEDEX Ground only. No COD shipments will be accepted.

Visit our website for the most current and complete OEM interchange



OEM	OEM Part #	Material Description	Graco Part # / Old Graco#
AMETEK-LAMB	31120	ROTATING FAN	86800990 / 31120
AMETEK-LAMB	31213	ROTATING FAN(8MM SHAFT)	86801010 / 31213
AMETEK-LAMB	31257	STATIONARY FAN	86801050 / 31257
AMETEK-LAMB	31279	Fan Rotating	86801080 / 31279
AMETEK-LAMB	31281	ROTATING FAN 3/07	86801090 / 31281
AMETEK-LAMB	31282	VAC FAN	86801100 / 31282
AMETEK-LAMB	31340	STATIONARY FAN	86801140 / 31340
AMETEK-LAMB	31360	STATIONARY FAN (115937)	86801180 / 31360
AMETEK-LAMB	31373	FAN	86801210 / 31373
AMETEK-LAMB	31417	FAN	86801220 / 31417
AMETEK-LAMB	33308	BRUSH MECH. EA. (33326-1 REPL 33308)	86801380 / 33308
AMETEK-LAMB	33357	CARBON BRUSH (OLD 33357) 33415-4	86801450 / 33357
AMETEK-LAMB	33384	BRUSH MECHANISM	86801420 / 33384
AMETEK-LAMB	33390	CARBON BRUSH	86801430 / 33390
AMETEK-LAMB	33392	CARBON BRUSH	86801430 / 33392
AMETEK-LAMB	33415	CARBON BRUSH (OLD 33357) 33415-4	86801450 / 33415
AMETEK-LAMB	33462	CARBON BRUSH W/HOLDER AMETEK	86801470 / 33462
AMETEK-LAMB	33494	CARBON BRUSH G2K 36V (SET/2)	86801500 / 33494
AMETEK-LAMB	35184	BRUSH & SPRING SPECIAL	86801530 / 35184
AMETEK-LAMB	35253	CARBON BRUSH (114787)	86801550 / 35253
AMETEK-LAMB	35277	CARBON BRUSH AMETEK 06/06	86801560 / 35277
AMETEK-LAMB	37926	HOUSING AMETEK	86802190 / 37926
AMETEK-LAMB	45957	ASSY. BRACKET AND SHELL AMETEK	86801770 / 45957
AMETEK-LAMB	114787	VACUUM MOTOR	86686220 / VM-10
AMETEK-LAMB	115330	VAC MOTOR, (QBA) 7.2",DB,2 STG, TYPE D P	86855060 / VM-9
AMETEK-LAMB	115334	120V,13.5AMP,2 STG (QBA) DUAL BALL VACUUM	86854400 / VM-11
AMETEK-LAMB	115419	VAC MOTOR	86623200 / VM-42
AMETEK-LAMB	115757	120 VOLT VAC MOTOR	86855020 / VM-7
AMETEK-LAMB	115923	VAC MOTOR(115923) (QBA) 120V 2STAGE	86854970 / VM-55
AMETEK-LAMB	115937	120V,12.7 AMP,2 STAGE VACUUM MTR. (QBA)	86854410 / VM-12
AMETEK-LAMB	115962	120V VAC MTR	86724030 / VM-17
AMETEK-LAMB	116125	SP. VAC MOTOR,220V.	86634840 / VM-21
AMETEK-LAMB	303744	FAN SHELL	86800910 / 303744
AMETEK-LAMB	303779	FAN SHELL	86800930 / 303779
AMETEK-LAMB	304068	FANSHELL	86800940 / 304068
AMETEK-LAMB	6037274	FAN SHELL	86800930 / 6037274
AMETEK-LAMB	116103-00	3 STAGE VAC MTR (QBA) (116103-00,117507-	86854460 / VM-14
AMETEK-LAMB	116118-00	3STAGE VACUUM MOTOR	86620570 / VM-28
AMETEK-LAMB	116155-00	24V VAC MOTOR (QBA) (116155-00)	86601190 / VM-1
AMETEK-LAMB	116156-00	36V 2 STAGE VAC MTR (QBA) (116156-00)	86854510 / VM-2
AMETEK-LAMB	116157-00	24 VOLT 2 STAGE VAC MOTOR	86854670 / VM-29
AMETEK-LAMB	116157-29	(k) VAC MOTOR (VM-29 w/ 1-1/2" TUBE) 458	98482060 / VM-29-B
AMETEK-LAMB	116157-32	(k) VAC MOTOR (VM-29w/1-7/8" TUBE)	98483190 / VM-29-A
AMETEK-LAMB	116158-00	36V DC VAC MTR (QBA) (116158-00)	86607400 / VM-20
AMETEK-LAMB	116158-01	VAC MOTOR 56395875	86854620 / VM-27
AMETEK-LAMB	116197-00	120 VOLT 3 STAGE VAC MOTOR	86854760 / VM-33
AMETEK-LAMB	116207-00	120 VOLT 2 STAGE VAC MOTOR (VM-13)	86854420 / VM-13
AMETEK-LAMB	116309-00	120 VOLT VAC MOTOR	86854990 / VM-6
AMETEK-LAMB	116309-01	120 VOLT VAC MOTOR (HARD FAN)	86855010 / VM-6-H
AMETEK-LAMB	116311-01	MOTOR 116311-01	86634780 / VM-51

OEM Interchange

Visit our website for the most current and complete OEM interchange



OEM	OEM Part #	Material Description	Graco Part # / Old Graco#
AMETEK-LAMB	116325-00	120V VACUUM MTR. (QBA) (116325)	86855050 / VM-8
AMETEK-LAMB	116336-00	120 VOLT VAC MOTOR	86855020 / VM-7
AMETEK-LAMB	116378-00	VAC MOTOR	86603040 / WV-19
AMETEK-LAMB	116392-00	120 VOLT 2 STAGE VAC MOTOR (VM-13)	86854420 / VM-13
AMETEK-LAMB	116455-50	120 VOLT VAC MOTOR	86854990 / VM-6
AMETEK-LAMB	116512-13	36V 3-STAGE VAC MOTOR (QBA) (119431-13)	86601200 / VM-24
AMETEK-LAMB	116513-13	36 VOLT 3 STAGE VAC MOTOR	86854650 / VM-280
AMETEK-LAMB	116513-29	36 VOLT 3 STAGE VAC MOTOR	86854720 / VM-30
AMETEK-LAMB	116513-32	VAC MOTOR (116513-32)	86634340 / VM-26
AMETEK-LAMB	116515-13	24 VOLT 3 STAGE VAC MOTOR	86854550 / VM-23
AMETEK-LAMB	116515-24	24 VOLT 3 STAGE VAC MOTOR	86854780 / VM-34
AMETEK-LAMB	116515-29	24 VOLT 3 STAGE VAC MOTOR	86854780 / VM-34
AMETEK-LAMB	116515-32	(K) VAC MOTOR 24V, 1-7/8" TUBE	98482100 / VM-34B
AMETEK-LAMB	116551-50	VAC MOTOR ASM, 115V 4.8 2ST PD	86026750 / VM-46
AMETEK-LAMB	116565-13	VAC MOTOR	86854580 / VM-25
AMETEK-LAMB	116565-29	120 VOLT 3 STAGE VAC MOTOR	86854740 / VM-31
AMETEK-LAMB	116566-00	120 VOLT 3 STAGE VAC MOTOR	86854760 / VM-33
AMETEK-LAMB	116566-13	120 VOLT 3 STAGE VAC MOTOR	86854760 / VM-33
AMETEK-LAMB	116598-13	Vacuum motor complete 24V C17/20 SVC	86005400 / VM-43
AMETEK-LAMB	116758-13	VAC MOTOR	86634760 / VM-54
AMETEK-LAMB	116764-13	120 VOLT 3 STAGE VAC MOTOR	86854760 / VM-33
AMETEK-LAMB	116881-50	120 VOLT VAC MOTOR	86854990 / VM-6
AMETEK-LAMB	116883-00	120 VOLT 2 STAGE VAC MOTOR	86854820 / VM-4
AMETEK-LAMB	116883-50	120 VOLT 2 STAGE VAC MOTOR	86854820 / VM-4
AMETEK-LAMB	117504-13	VAC MOTOR	86724040 / VM-47
AMETEK-LAMB	117505-13	MOTOR, VAC (QBA) (NSS CHAMP ZS 35) (LAMB	86854980 / VM-56
AMETEK-LAMB	117507-13	3 STAGE VAC MTR (QBA) (116103-00,117507-	86854460 / VM-14
AMETEK-LAMB	119322-00	FAN VACUUM	86657610 / VM-53
AMETEK-LAMB	119431-13	36V 3-STAGE VAC MOTOR (QBA) (119431-13)	86601200 / VM-24
AMETEK-LAMB	119432-13	36 VOLT 3 STAGE VAC MOTOR	86854650 / VM-280
AMETEK-LAMB	119432-29	36 VOLT 3 STAGE VAC MOTOR	86854720 / VM-30
AMETEK-LAMB	119433-13	24 VOLT 3 STAGE VAC MOTOR	86854550 / VM-23
AMETEK-LAMB	119433-29	24 VOLT 3 STAGE VAC MOTOR	86854780 / VM-34
AMETEK-LAMB	119434-13	36V DC VAC MTR (QBA) (116158-00)	86607400 / VM-20
AMETEK-LAMB	119436-13	24 VOLT 2 STAGE VAC MOTOR	86854670 / VM-29
AMETEK-LAMB	121118-00	MOTOR, INFIMATEK 120V. 121118-00	86896680
AMETEK-LAMB	30-3744	FAN SHELL	86800910 / 30-3744
AMETEK-LAMB	31278-1	FAN	86801070 / 31278-1
AMETEK-LAMB	33326-1	BRUSH MECH. EA. (33326-1 REP'L 33308)	86801380 / 33326-1
AMETEK-LAMB	33392-11	CARBON BRUSH	86801430 / 33392-11
AMETEK-LAMB	33392-5	BRUSH & BRUSH HOLDER (GREEN HOLDER) AMET	86801440 / 33392-5
AMETEK-LAMB	33415-1	CARBON BRUSH (OLD 33357) 33415-4	86801450 / 33415-1
AMETEK-LAMB	33415-4	CARBON BRUSH (OLD 33357) 33415-4	86801450 / 33415-4
AMETEK-LAMB	33423-19	CARBON BRUSH AMETEK	86801460 / 33423-19
AMETEK-LAMB	33490-1	CARBON BRUSH G2K 24V	86801490 / 33490-1
AMETEK-LAMB	45847-14	SHELL & TUBE 1 7/8"	86689930 / 45847-14
AMETEK-LAMB	45849-1	INTAKE TUBE W/SHELL	86801750 / 45849-1
AMETEK-LAMB	45899-14	FAN SHELL W/TUBE 1 1/2"	86689990 / 45899-14
AMETEK-LAMB	60-3727-14	FAN SHELL	86800930 / 60-3727-14
AMETEK-LAMB	80-3721-4	VENT FAN HOUSING G2K	86802570 / 80-3721-4

Visit our website for the most current and complete OEM interchange



OEM Interchange: Aztec/Betco/Eagle Power/Eagle Solutions

OEM Interchange

OEM	OEM Part #	Material Description	Graco Part # / Old Graco#
AZTEC	237-500HG	Gasket	88054270 / 237-500HG
BETCO	AS26/321230	DRAIN PLUG 1 1/2"621324	86601910 / VTN-1
BETCO	AS26/321353	CUFF, HOSE 1.5" BLK A 2161	86003010 / HC-7B
BETCO	AS26050	MOTOR ASM, 24VDC 200RPM GEAR	86005320 / MTC-5A+
BETCO	AS26050-1	VAC MOTOR,24V.3-STG	86854560 / VM23A+
BETCO	AS261230	DRAIN PLUG 1 1/2"621324	86601910 / VTN-1
BETCO	AS261269	REAR SQ. 260264	86639960 / MM-260-3A
BETCO	AS261270	REINFORCEMENT BLADE 260264	86639970 / MM-260-3B
BETCO	AS261273	FRONT SQ.260265	86639980 / MM-260-3C
BETCO	AS261274	GASKET 260294	86620350 / MM-G-1
BETCO	AS261370	BREAKER, 30A 50VDC CIRCUIT - VAC MOTOR	86001910 / EA-29
BETCO	AS261372	SWITCH	86652590 / ETN-1
BETCO	AS26321274	GASKET 260294	86620350 / MM-G-1
BETCO	AS26321370	BREAKER, 30A 50VDC CIRCUIT - VAC MOTOR	86001910 / EA-29
BETCO	AS26321371	CIRCUIT BREAKER-70 AMP	86608530 / EA-70
BETCO	AS26400	Connector 175 DCA RED W/O TERMS	88068240 / CHP-3-R
BETCO	AS26930	CHARGER 24V 12A AUTO (50A RED)	86600920 / CH-10
BETCO	AS32050-1	VAC MOTOR, 36V 5.7 3ST TD	86258480 / VM-280A+
BETCO	AS321230	DRAIN PLUG 1 1/2"621324	86601910 / VTN-1
BETCO	AS321269	SQUEEGEE, FRONT	86620590 / HMC-320-3A
BETCO	AS321270	REINFORCMENT BLADE 320195	86640060 / HMC-320-3B
BETCO	AS321273	SQUEEGEE,REAR	86620600 / HMC-320-3C
BETCO	AS321274	GASKET 260294	86620350 / MM-G-1
BETCO	AS321370	BREAKER, 30A 50VDC CIRCUIT - VAC MOTOR	86001910 / EA-29
BETCO	AS321372	SWITCH	86652590 / ETN-1
EAGLE POWER	MPVR45194	BLADE FRONT	86657260 / E-20-2B
EAGLE POWER	MPVR45195	BLADE REAR	86657270 / E-20-2A
EAGLE POWER	MTCG00019	Belt with Instruction Sheet	98486340
EAGLE POWER	SL02303J	Vacuum motor complete 24V C17/20 SVC	86005400 / VM-43
EAGLE POWER	SL02303-J	Vacuum motor complete 24V C17/20 SVC	86005400 / VM-43
EAGLE POWER	SL03517	BLADE FRONT	86657260 / E-20-2B
EAGLE POWER	SL03518	BLADE REAR	86657270 / E-20-2A
EAGLE POWER	SL03563	SQUEEGEE BLADES	86722690 / E-2832-2A
EAGLE POWER	SL03564	SQUEEGEE BLADES	86722700 / E-2832-2B
EAGLE SOLUTIONS	1015	THROTTLE CABLE (LEFT) UNIVERSAL	86847550 / PB-4L
EAGLE SOLUTIONS	1155	COUPLER FEMALE	86717420 / PB-13
EAGLE SOLUTIONS	1200	WHEEL 6", 3/8" BORE. GRAY RUBBER	88061520
EAGLE SOLUTIONS	1205	Wheel with Bracket 6.75" Overall Height	86637020
EAGLE SOLUTIONS	1235	IDLER, PULLEY 4"	86652140
EAGLE SOLUTIONS	1355	FLANGE	86642180
EAGLE SOLUTIONS	1410	CENTERLOCK-PAD HOLDER	86633860 / PH-7
EAGLE SOLUTIONS	1550	STARTER	86633430 / PB-3
EAGLE SOLUTIONS	3335	BELT	86643930
EAGLE SOLUTIONS	68177	PAD DRIVER FLEX 21" W/O DRIVE FLANGE	86704810
EAGLE SOLUTIONS	680116	BELT OPTIBELT	86830750
EAGLE SOLUTIONS	680157	21"FLEX PAD DRIVER ASSY. COMPLETE	98486070
EAGLE SOLUTIONS	680158	24"FLEX PAD DRIVER ASSY. COMPLETE	98486080
EAGLE SOLUTIONS	680159	27"FLEX PAD DRIVER ASSY. COMPLETE	98486090
EAGLE SOLUTIONS	680178	PAD DRIVER FLEX, 27"	86704820
EaGLE SOLUTIONS	680224	BONNET FILTER, SHORT 3.25" X 9.5"	86636780 / PB-162

Visit our website for the most current and complete OEM interchange



OEM	OEM Part #	Material Description	Graco Part # / Old Graco#
EaGLE SOLUTIONS	680226	SOLENOID -STARTER 12V	86635790
EAGLE SOLUTIONS	680238	24" FLEX PAD ASSY W/O DRIVE FLANGE	86694850
EAGLE SOLUTIONS	680355	27" METAL PAD DRIVER COMPLETE	86864250
EAGLE SOLUTIONS	680422	(K) MAINTENANCE KIT*FOR ONAN 20HP	98482220 / PM-O20
EAGLE SOLUTIONS	680426	K) MAINTENANCE KIT* FOR HONDA 13HP (GXV	98482230 / PM-H13
EAGLE SOLUTIONS	680428	(k) MAINTENANCE KIT* FOR KAWASAKI 17 (SH	98482210 / PM-K17
EAGLE SOLUTIONS	680678	27" PAD DRIVER FACING ONLY	86889060
ELECTROLUX	TYPE U	BAGS, PAPER 4-PLY, 12PK, (QBA) (ELECTROL	86848380 / PBE-4
EUREKA-SANITAIRE	12988	FAN, LEXAN	86711430 / FE-1
EUREKA-SANITAIRE	13684	GASKET	86647890 / VCP-39
EUREKA-SANITAIRE	13685	PEDAL, FOOT	86853120 / VCP-28
EUREKA-SANITAIRE	13686	FOOT PEDAL SPRING	86723930 / VCP-29
EUREKA-SANITAIRE	13879	WHEEL, FRONT	86853150 / VCP-30
EUREKA-SANITAIRE	26833	KNOB	86644520 / VCP-10
EUREKA-SANITAIRE	30478	CARBON BRUSH (EACH)	86853210 / VCP-36
EUREKA-SANITAIRE	30517	GASKET	86647890 / VCP-39
EUREKA-SANITAIRE	35293	HANDLE GRIP(GREY)	86853160 / VCP-31
EUREKA-SANITAIRE	36261	BRUSH ASSY.HEX END	86633530 / BRE-2
EUREKA-SANITAIRE	37034	ADAPTER RETAINER SPRING	86723960 / VCP-9
EUREKA-SANITAIRE	38495	SPRING,STRAIN RELIEF	86723950 / VCP-48
EUREKA-SANITAIRE	49017	WASHER, FAN (EA) (53148)	86853110 / VCP-27
EUREKA-SANITAIRE	52100	BELT (QBA)	86600880 / BLE-3
EUREKA-SANITAIRE	52264	BRUSHSTRIP (Blk)	86656820 / VCP-19
EUREKA-SANITAIRE	52282	BRISTLE STRIP (SET) (Blu/Org)	86641620 / VCP-18
EUREKA-SANITAIRE	52320	PAPER BAG (3 PACK) (QBA)	86848300 / PBC-300
EUREKA-SANITAIRE	53097	FOOT PEDAL SPRING	86723930 / VCP-29
EUREKA-SANITAIRE	53117	SPRING	86723940 / VCP-33
EUREKA-SANITAIRE	53121	PUSH NUT (EA)	86853270 / VCP-41
EUREKA-SANITAIRE	53122	BUSHING, STRAIN RELIEF EACH	86853380 / VCP-51
EUREKA-SANITAIRE	53143	SCREW, SHOULDER	86853330 / VCP-47
EUREKA-SANITAIRE	53148	WASHER, FAN (EA) (53148)	86853110 / VCP-27
EUREKA-SANITAIRE	53272	DISTRIBUTOR ASSEMBLY, FLAT 12"	86853070 / VCP-22
EUREKA-SANITAIRE	53273	DISTRIBUTOR ASSEMBLY 16"	86853090 / VCP-24
EUREKA-SANITAIRE	53474	BASE KIT	86641610 / VCP-14
EUREKA-SANITAIRE	53500	BASE ASSEMBLY, RED 16"	86853000 / VCP-15
EUREKA-SANITAIRE	53574	(k) CORD RETAINER HOOK SET	98482050 / VCP-23
EUREKA-SANITAIRE	54352	MOTOR ASSY	86649300 / VCP-37
EUREKA-SANITAIRE	56263	COVER, WHEEL	86853370 / VCP-50
EUREKA-SANITAIRE	56379	AIR INLET DUCT, RIGHT SIDE	86852970 / VCP-12
EUREKA-SANITAIRE	56380	AIR INLET DUCT, LEFT SIDE	86852960 / VCP-11
EUREKA-SANITAIRE	60285	FILTER, HEPA (EUREKA VICTORY/WHIRLWIND)	86839790 / FE-4
EUREKA-SANITAIRE	62112	BAG,PAPER 6QT.10/PK	86633130 / PBT-1
EUREKA-SANITAIRE	5237012	CORD,18-3/50' BEIGE	86633290 / VCP-6
EUREKA-SANITAIRE	12637-8	HANDLE TUBE, LOWER	86853190 / VCP-34
EUREKA-SANITAIRE	12988-1	FAN, LEXAN	86711430 / FE-1
EUREKA-SANITAIRE	12988-2	FAN, LEXAN	86711430 / FE-1
EUREKA-SANITAIRE	12988-3	FAN, LEXAN	86711430 / FE-1
EUREKA-SANITAIRE	13770-1	COVER, FAN CHAMBER, CLEAR	86853100 / VCP-26
EUREKA-SANITAIRE	24716C-7	RED TOP FILL CLOTH BAG	86633510 / FBE-84
EUREKA-SANITAIRE	24834A	PEDAL, FOOT	86853120 / VCP-28

Visit our website for the most current and complete OEM interchange



OEM	OEM Part #	Material Description	Graco Part # / Old Graco#
EUREKA-SANITAIRE	24834A-1	PEDAL, FOOT	86853120 / VCP-28
EUREKA-SANITAIRE	25329-20	HANDLE, UPPER ASSEMBLY W/GRIP	86853350 / VCP-49
EUREKA-SANITAIRE	25544-2	RED ZIPPER BAG W/SPRING	86717490 / FBE-84-Z
EUREKA-SANITAIRE	25672A	BOTTOM PLATE ASSMBLY, 16"	86723910
EUREKA-SANITAIRE	25922-1	BOTTOM PLATE	86659480 / VCP-16
EUREKA-SANITAIRE	26057A	CAP, DISTRIBUTOR END (METAL)	86853310 / VCP-45
EUREKA-SANITAIRE	26059A	CAP, DISTRIBUTOR (RUBBER) EA.	86853060 / VCP-20
EUREKA-SANITAIRE	26242-1	WHEEL, REAR	86853290 / VCP-43
EUREKA-SANITAIRE	26296-9	BUMPER, 12" (QBA)	86853250 / VCP-4
EUREKA-SANITAIRE	26833-1	KNOB	86644520 / VCP-10
EUREKA-SANITAIRE	27564-1	BUMPER, 12" (QBA)	86853250 / VCP-4
EUREKA-SANITAIRE	27564-2	BUMPER, 16" (QBA)	86853360 / VCP-5
EUREKA-SANITAIRE	28504-1	BUMPER, 12" (QBA)	86853250 / VCP-4
EUREKA-SANITAIRE	28729B	TOOL, 18" SQUEEGEE	86655860 / WWRHD
EUREKA-SANITAIRE	30563A	BELT (QBA)	86600880 / BLE-3
EUREKA-SANITAIRE	30563A	DRIVE BELT, ORIGINAL	86816370 / BLE-3M
EUREKA-SANITAIRE	35293-8	HANDLE GRIP(GREY)	86853160 / VCP-31
EUREKA-SANITAIRE	35859A-1	WHEEL, FRONT	86853150 / VCP-30
EUREKA-SANITAIRE	36409-13	SWITCH-PUSH	86641660 / VCP-2
EUREKA-SANITAIRE	36648A	HANDLE SOCKET ASSEMBLY W/ SPRING	86853170 / VCP-32
EUREKA-SANITAIRE	36648A-2	HANDLE SOCKET ASSEMBLY W/ SPRING	86853170 / VCP-32
EUREKA-SANITAIRE	36648A-2SV	HANDLE SOCKET ASSEMBLY W/ SPRING	86853170 / VCP-32
EUREKA-SANITAIRE	37012-2	PULLEY	86853260 / VCP-40
EUREKA-SANITAIRE	37234-1	REAR WHEEL/AXLE ASSEMBLY	86853300 / VCP-44
EUREKA-SANITAIRE	38183-1	HANDLE SOCKET ASSEMBLY W/ SPRING	86853170 / VCP-32
EUREKA-SANITAIRE	38183SV	HANDLE SOCKET ASSEMBLY W/ SPRING	86853170 / VCP-32
EUREKA-SANITAIRE	50681A	BRUSHSTRIP (Blk)	86656820 / VCP-19
EUREKA-SANITAIRE	52282-3	BRISTLE STRIP (SET) (Blu/Org)	86641620 / VCP-18
EUREKA-SANITAIRE	52282-4	BRISTLE STRIP (SET) (Blu/Org)	86641620 / VCP-18
EUREKA-SANITAIRE	52282-6	BRISTLE STRIP (SET) (Blu/Org)	86641620 / VCP-18
EUREKA-SANITAIRE	52370-12	CORD,18-3/50' BEIGE	86633290 / VCP-6
EUREKA-SANITAIRE	53198-1	SCREW W/NUT	86674170 / VCP-46
EUREKA-SANITAIRE	53474-3	BASE KIT	86641610 / VCP-14
EUREKA-SANITAIRE	53500-4	BASE ASSEMBLY, RED 16"	86853000 / VCP-15
EUREKA-SANITAIRE	53506-1	RED ZIPPER BAG W/SPRING	86717490 / FBE-84-Z
EUREKA-SANITAIRE	53574-1	(k) CORD RETAINER HOOK SET	98482050 / VCP-23
EUREKA-SANITAIRE	54097-2	HOOD	86641600 / VCP-35
EUREKA-SANITAIRE	54139-1	MOTOR BASE ASSEMBLY	86853230 / VCP-38
EUREKA-SANITAIRE	54352-2	MOTOR ASSY	86649300 / VCP-37
EUREKA-SANITAIRE	54352-3	MOTOR ASSY	86649300 / VCP-37
EUREKA-SANITAIRE	54582-1	RED TOP FILL CLOTH BAG	86633510 / FBE-84
EUREKA-SANITAIRE	54582-2	BLACK CLOTH BAG, TOP FILL	86720420 / FBE-84-B
EUREKA-SANITAIRE	54924A-10	PAPER BAG (3 PACK) (QBA)	86848300 / PBC-300
EUREKA-SANITAIRE	56379SV	AIR INLET DUCT, RIGHT SIDE	86852970 / VCP-12
EUREKA-SANITAIRE	56380SV	AIR INLET DUCT, LEFT SIDE	86852960 / VCP-11
EUREKA-SANITAIRE	82282-2	BRISTLE STRIP (SET) (Blu/Org)	86641620 / VCP-18
EUREKA-SANITAIRE	E12988R-1	FAN, LEXAN	86711430 / FE-1
EUREKA-SANITAIRE	E26063A	DISTRIBUTOR ASSEMBLY 16"	86853090 / VCP-24
EUREKA-SANITAIRE	E36261RM	BRUSH ASSY.HEX END	86633530 / BRE-2
EUREKA-SANITAIRE	E52282R	BRISTLE STRIP (SET) (Blu/Org)	86641620 / VCP-18

Visit our website for the most current and complete OEM interchange



OEM	OEM Part #	Material Description	Graco Part # / Old Graco#
EUREKA-SANITAIRE	F&G	PAPER BAG (3 PACK) (QBA)	86848300 / PBC-300
FACTORY CAT	22-754G	Squeegee Blade,Rear,Gum Fits 32" Sq. Assy.	88062400
FACTORY CAT	22-754GT	Squeegee Blade,Rear,Gum Thin,Fits 32" Sq. Assy.	88062410
FACTORY CAT	22-754L	Squeegee Blade,Rear, Red, Fits 32" Sq. Assy.	88062420
FACTORY CAT	22-755G	Squeegee Blade,Front,Gum Fits 32" Sq. Assy.	88062430
FACTORY CAT	22-755GT	Squeegee Blade,Front,Gum Thin,Fits 32" Sq. Assy.	88062440
FACTORY CAT	22-755L	Squeegee Blade,Front, Red Fits 32" Sq. Assy.	88062450
FACTORY CAT	253-1320	CURTAIN, JAW 13"	88062710
FACTORY CAT	253-1520	CURTAIN, JAW	88062720
FACTORY CAT	253-1720	CURTAIN, JAW 17"	88062730
FACTORY CAT	253-9010L	Wiper,Cylindrical	88062690
FACTORY CAT	25-754G	Squeegee Blade,Rear,Gum Fits 35" Sq. Assy.	88062470
FACTORY CAT	25-754GT	Squeegee Blade,Rear,Gum Thin,Fits 35" Sq. Assy.	88062480
FACTORY CAT	25-754L	Squeegee Blade,Rear,Red Fits 35" Sq. Assy.	88062490
FACTORY CAT	25-755G	Squeegee Blade,Front,Gum Fits 35" Sq. Assy.	88062530
FACTORY CAT	25-755GT	Squeegee Blade,Front,Gum Thin,Fits 35" Sq. Assy.	88062540
FACTORY CAT	25-755L	Squeegee Blade,Front,Red Fits 35" Sq. Assy.	88062550
FACTORY CAT	28-754G	Squeegee Blade,Rear,Gum Fits 38" Sq. Assy.	88062560
FACTORY CAT	28-754GT	Squeegee Blade,Rear,Gum Thin,Fits 38" Sq. Assy.	88062570
FACTORY CAT	28-754L	Squeegee Blade,Rear, Red Fits 38" Sq. Assy.	88062580
FACTORY CAT	28-755G	Squeegee Blade,Front,Gum Fits 38" Sq. Assy.	88062600
FACTORY CAT	28-755GT	Squeegee Blade,Front,Gum Fits 38" Sq. Assy.	88062610
FACTORY CAT	28-755L	Squeegee Blade,Front, Red Fits 38" Sq. Assy.	88062620
FACTORY CAT	290-756G	Squeegee Blade,Front,Gum Fits 45" Sq. Assy.	88062640
FACTORY CAT	290-756L	Squeegee Blade,Front, Red Fits 45" Sq. Assy.	88062650
FACTORY CAT	5-225	24V 3-STAGE VAC MOTOR	86634360 / VM-45
FACTORY CAT	5-708A	VACUUM MOTOR GASKET	86839430 / FB2496
FACTORY CAT	5-709A	Filter VAC MOTOR	86003510 / FA-1
FACTORY CAT	7-753G	Squeegee Blade,Rear,Gum Fits 45" Sq. Assy.	88062670
FACTORY CAT	7-753L	Squeegee Blade,Rear, Red Fits 45" Sq. Assy.	88062680
HILD	24870A	LEVER - SWITCH (TRIGGER) METEOR	86608620 / GS2000-17
HILD	B115267	BUMPER WHEEL	86618540 / WA-10
HILD	B200129	FILTER - MOTOR	86608590 / B200129
HONDA	11301-ZE9-000	GASKET	86639590 / PB-23
HONDA	11381-ZE9-000	GASKET	86639590 / PB-23
HONDA	12209-Z-E8-003	VALVE SEAT	86643820 / PB-154
HONDA	12251-ZE9-900	HEAD GASKET	86634530 / PB-18
HONDA	12251-ZF5-000	HEAD GASKET GXV390	86635700 / PB-147
HONDA	12391-ZE8-000	VALVE COVER GASKET	86637030 / PB-21
HONDA	15400-P0H-305PE	FILTER,OIL-GXV390	86636160 / PB-152
HONDA	15630-ZE8-000	OIL FILTER TUBE	86636280 / PB-24
HONDA	17210-ZE8-810	AIR CLEANER ELEMENT	86634440 / PB-20
HONDA	30500-ZE9-L32	MAG. COIL, HONDA	86635800 / PB-159
HONDA	30500-ZE9-L33	MAG. COIL, HONDA	86635800 / PB-159
HONDA	91201-ZE3-004	*OIL SEAL	86634450 / PB-22
HONDA	91301-ZE9-003	O-RING	86639550 / PB-25
HONDA	98079-55846	SPARK PLUG	86636500 / PB-19
HOOVER	49258	BELT-HOOVER (QBA)	86828920 / BLH-1
HOOVER	27149001	CHARGER 36V 20A AUTO.56395101	86738030 / CH-63
HOOVER	28452005	SOLENOID 36V.6POLE 788147	86607790 / EC-81

Visit our website for the most current and complete OEM interchange



OEM Interchange: Hoover/Kaivac/Kawasaki

OEM	OEM Part #	Material Description	Graco Part # / Old Graco#
HOOVER	39512003	SQUEEGEE FRONT-26	86841330 / HV-6075-3C
HOOVER	39512004	SQUEEGEE-REAR GUM-26	86841310 / HV-6075-3A
HOOVER	39512005	SQUEEGEE-REAR BACK UP-26	86841320 / HV-6075-3B
HOOVER	59187107	DRAIN VALVE	86634390 / VC-72
HOOVER	59187110	SPLASH GUARD	86841340 / HV-6075-S
HOOVER	59187115	BATTERY CABLE	86827870 / BCSN410
HOOVER	59187116	BATTERY CABLE (QBA)	86827880 / BCSN412
HOOVER	59187117	BATTERY CABLE	86827700 / BC421R
HOOVER	59187118	BATTERY CABLE	86827690 / BC421B
HOOVER	59187139	Filter VAC MOTOR	86003510 / FA-1
HOOVER	59187191	#35 LINK CONN.895101	86633930 / BLC-35
HOOVER	59187199	40 LINK,CONN.	86633920 / BLAL-9
HOOVER	591871177	SWITCH 56325758	86634370 / ETN-15
HOOVER	4010001A	PAPER BAG (PK) HOOVER,A	86633170 / PBH-1
HOOVER	4010324A	PAPER BAG (PK) HOOVER,A	86633170 / PBH-1
HOOVER	STYLEA	PAPER BAG (PK) HOOVER,A	86633170 / PBH-1
HOOVER	TYPEA	PAPER BAG (PK) HOOVER,A	86633170 / PBH-1
KAIVAC	CVS01A	120 VOLT 2 STAGE VAC MOTOR (VM-13)	86854420 / VM-13
KAIVAC	CVS01A	(K)VAC MOTOR, 120V, 2 STAGE, 1 1/2 TUBE	98481640 / VM-13B
KAIVAC	CVS01C	(K)VAC MOTOR, 120V, 2 STAGE, 1 1/2 TUBE	98481640 / VM-13B
KAIVAC	SUBGA	PRESSURE GUN ASSY, WHITE DOT, KAIVAC	98486300
KAIVAC	SUBGAKW	PRESSURE GUN ASSY, GREEN DOT, KAIVAC	98486330
KAWASAKI	211637012	STARTER KAWASAKI 110V.	86636930 / PB-164
KAWASAKI	11004-7001	HEAD GASKET	86635560 / PB-121
KAWASAKI	11004-7005	HEAD GASKET	86635560 / PB-121
KAWASAKI	11004-7010	HEAD GASKET	86742430
KAWASAKI	11004-7015	HEAD GASKET	86635560 / PB-121
KAWASAKI	11004-7016	HEAD GASKET	86742430
KAWASAKI	11013-7001	ELEMENT AIR FILTER	86635410 / PB-122
KAWASAKI	11013-7006	AIR FILTER KAWASAKI	86635210 / PB-123
KAWASAKI	11013-7033	ELEMENT AIR FILTER	86635410 / PB-122
KAWASAKI	11038-7001	CASE ASSY AIR FILTER	86635570 / PB-124
KAWASAKI	11038-7011	CASE ASSY AIR FILTER	86635570 / PB-124
KAWASAKI	11038-7013	CASE ASSY AIR FILTER	86635570 / PB-124
KAWASAKI	11060-7001	GASKET ROCKER C	86635600 / PB-125
KAWASAKI	11060-7003	CARB MTG GASKET	86635430 / PB-126
KAWASAKI	11060-7004	GASKET AIR FILTER	86635610 / PB-127
KAWASAKI	11060-7005	INTAKET MANIFOLD GASKET	86635900 / PB-128
KAWASAKI	11060-7006	EXHAUST GASKET	86635450 / PB-129
KAWASAKI	11060-7021	EXHAUST GASKET	86635450 / PB-129
KAWASAKI	130B0635	BOLT-FLANGED 6X	86636060 / PB-130
KAWASAKI	13116-2057	PUSH ROD	86636330 / PB-131
KAWASAKI	14075-7001	DIPSTICK OIL	86635440 / PB-148
KAWASAKI	21163-7001	STARTER 12V - kawasaki 17 hp.	86636390 / PB-156
KAWASAKI	21163-7010	STARTER 12V - kawasaki 17 hp.	86636390 / PB-156
KAWASAKI	21163-7012	STARTER KAWASAKI 110V.	86636930 / PB-164
KAWASAKI	21171-7001	IGNITION COIL ASSY	86635530 / PB-134
KAWASAKI	21171-7013	IGNITION COIL ASSY	86635530 / PB-134
KAWASAKI	311B0600	NUT 6MM	86635980 / PB-135
KAWASAKI	49065-2078	OIL FILTER	86636100 / PB-139

OEM Interchange

Visit our website for the most current and complete OEM interchange



OEM	OEM Part #	Material Description	Graco Part # / Old Graco#
KAWASAKI	49109-7002	ELEMENT	86742440
KAWASAKI	59231-7001	HOLDER DIPSTICK	86635640 / PB-149
KAWASAKI	670D2016	O-RING	86636080 / PB-140
KAWASAKI	92049-7001	OIL SEAL	86636270 / PB-142
KAWASAKI	92049-7002	MAIN OIL SEAL, UPPER	86751240
KAWASAKI	92049-7004	OIL SEAL	86716880 / PB-143
KAWASAKI	92049-7010	MAIN OIL SEAL, UPPER	86751240
KAWASAKI	92049-7011	OIL SEAL	86716880 / PB-143
KAWASAKI	92070-7001	SPARK PLUG	86637010 / PB-151
KAWASAKI	N1481025	REGULATOR,CENTURY G85-4012	86636690 / PB-153
KAWASAKI	11013-7021	ELEMENT AIR FILTER,KAWASAKI 13HP	86890920
KAWASAKI	11013-7034	ELEMENT AIR PREFILTER,KAWASAKI 13HP	86890930
KAWASAKI	11060-7007	GASKET, CRANK CASE KAWASAKI FH500V-AS03	86847120 / PB-63
KAWASAKI	11060-7008	GASKET, CRANK CASE KAWASAKI FH500V-AS03	86847120 / PB-63
KOHLER	1204104	HEAD GASKET,KOHLER	86634420 / PB-30
KOHLER	1204108	HEAD GASKET,KOHLER	86634420 / PB-30
KOHLER	1205002	FILTER, BONNET	86609520 / PB-36
KOHLER	1208305	AIR CLEANER	86617290 / PB-31
KOHLER	1208308	AIR CLEANER BAND	86636050 / PB-32
KOHLER	1209807	STARTER (KOHLER)	86636520 / PB-33
KOHLER	1209816	STARTER (KOHLER)	86636520 / PB-33
KOHLER	1209823	STARTER (KOHLER)	86636520 / PB-33
KOHLER	1213202	SPARK PLUG	86636510 / PB-37
KOHLER	5205002	OIL FILTER	86636290 / PB-34
MINUTEMAN	200345	WHEEL CASTER 56206725	86608720 / WA-3
MINUTEMAN	210230	DRAIN VALVE	86634390 / VC-72
MINUTEMAN	210352	REAR SQUEEGEE BLADE 36" (QBA)	86843860 / MM-200-2A
MINUTEMAN	210354	FRONT SQUEEGEE BLADE (QBA)	86843870 / MM-200-2B
MINUTEMAN	220444	FILTER BONNET HI TOP KAWA	86636770 / PB-161
MINUTEMAN	260109	BLADE, GUM 2"x3/16"x33" - 15 Holes	86841130 / HMC-26-3A
MINUTEMAN	260120	SQUEEGEE SET	98485810 / HMC-26-3
MINUTEMAN	260160	(k) RECOVERY HOSE ASY MM-260B	98481250 / VHM-1
MINUTEMAN	260178	3/8 TEE	86644030 / M-52-T
MINUTEMAN	260202	(K) HOSE, 1-1/2" DRAIN (36" WHITE WIRE,	98481920 / VHM-3
MINUTEMAN	260242	BLADE SQUEEGEE, GUM FRONT	88050000
MINUTEMAN	260243	BLADE SQUEEGEE, GUM REAR	88050010
MINUTEMAN	260263	REAR SQ. 260263	86639960 / MM-260-3A
MINUTEMAN	260264	REINFORCEMENT BLADE 260264	86639970 / MM-260-3B
MINUTEMAN	260265	FRONT SQ.260265	86639980 / MM-260-3C
MINUTEMAN	260294	GASKET 260294	86620350 / MM-G-1
MINUTEMAN	281613	SKIRT, GUM FOR 28-32" MM	86749660
MINUTEMAN	281785	SQ BLADE MM-ES260-2B	86732600
MINUTEMAN	281786	SQ BLADE,REAR MM-ES260-2A	86732610
MINUTEMAN	281789	SQUEEGEE SET, 32" GUM ES260 & ES320	98486010 / MM-ES260-2
MINUTEMAN	300195	FLAP	86848060 / PB-90-F
MINUTEMAN	300334	BACK-UP BLADE TSS-90	86848030 / PB-90-3B
MINUTEMAN	300553	FRONT SQUEEGEE BLADE TSS-90	86848040 / PB-90-3C
MINUTEMAN	320013	4X1 WHEEL	86855670 / WC-23
MINUTEMAN	320014	SQ BLADE FRONT	86696880 / MM-320HD-2B
MINUTEMAN	320015	SQ BLADE REAR	86696890 / MM-320HD-2A

Visit our website for the most current and complete OEM interchange



OEM	OEM Part #	Material Description	Graco Part # / Old Graco#
MINUTEMAN	320016	SQ. FRONT 320 RED	86620620 / MM-320R-2B
MINUTEMAN	320017	SQUEEGEE BLADE, (QBA) REAR LINATEX FOR 3	86843990 / MM-320R-2A
MINUTEMAN	320018	SQUEEGEE SET, (QBA) Linatex for 320* (New Style)	98485600 / MM-320R-2
MINUTEMAN	320019	SQUEEGEE SET, (QBA) GUM FOR 320* (New Style)	98485120 / MM-320HD-2
MINUTEMAN	320194	SQUEEGEE,REAR	86620600 / HMC-320-3C
MINUTEMAN	320195	REINFORCMENT BLADE 320195	86640060 / HMC-320-3B
MINUTEMAN	320196	SQUEEGEE, FRONT	86620590 / HMC-320-3A
MINUTEMAN	320261	FRONT BLADE	86672360 / HMC-320R-3C
MINUTEMAN	320262	REAR BLADE	86672370 / HMC-320R-3A
MINUTEMAN	320263	RED GUM SQUEEGEE SET	86672380 / HMC-320R-3
MINUTEMAN	320269	STRAP - TS-2	86622050 / TS-2
MINUTEMAN	320902	TIRE & RIM ASSY	86642750 / WTN-8
MINUTEMAN	320950	SQ BLADE	86843940 / MM-2832-2B
MINUTEMAN	320951	SQ BLADE REAR	86843930 / MM-2832-2A
MINUTEMAN	361006	BELT 3VX475	86687750 / BLM-2
MINUTEMAN	380002	SWITCH, TOGGLE	86606630 / EA-3
MINUTEMAN	380064	FOAM RING	86649510 / R-HK-1
MINUTEMAN	430077	SQUEEGEE BLADE- GUM	86634810
MINUTEMAN	430325	CASTER	86640260 / 86640260
MINUTEMAN	450090	(k) RECOVERY HOSE, NEW STYLE (MM 320 & A	98481420 / VHM-2
MINUTEMAN	602951	CIRCUIT BREAKER 35AMP (QBA)	86608910 / EA-35
MINUTEMAN	740029	SWITCH	86634620 / EA-32
MINUTEMAN	740063	24 VOLT 2 STAGE VAC MOTOR	86854670 / VM-29
MINUTEMAN	740097	50A.PLUG (RED)911185	86634110 / CHP-2-R
MINUTEMAN	740107	SWITCH	86652590 / ETN-1
MINUTEMAN	740127	SOLENOID 36V.56395452,	86606490 / EC-43
MINUTEMAN	740129	SWITCH EA-14	86616090 / EA-14
MINUTEMAN	740130	15A.CIRCUIT BRK.740130	86618740 / EA-34
MINUTEMAN	740131	CIRCUIT BREAKER-70 AMP	86608530 / EA-70
MINUTEMAN	740133	LIGHT INDICATOR - ADVANCE	86608630 / APL-1
MINUTEMAN	740135	AMMETER, DC	86608650 / EAM-4
MINUTEMAN	740136	METER-BATT.COND. 56448677	86608640 / EAM-3
MINUTEMAN	740147	Connector 175 DCA GRY W/O TERMS	88068250 / CHP-3
MINUTEMAN	740159	Connector 175 DCA RED W/O TERMS	88068240 / CHP-3-R
MINUTEMAN	740202	RECTIFIER 50A.	86637330 / EC-61
MINUTEMAN	740209	MOTOR/GEAR UNIT	86844120 / MTC-5
MINUTEMAN	740225	24 VOLT 3 STAGE VAC MOTOR	86854550 / VM-23
MINUTEMAN	740228	36 VOLT 3 STAGE VAC MOTOR	86854650 / VM-280
MINUTEMAN	740232	120 VOLT 2 STAGE VAC MOTOR (VM-13)	86854420 / VM-13
MINUTEMAN	740243	Relay 36VDC 100AMP HVY DUTY	86006370 / EA-80
MINUTEMAN	740247	BREAKER, 30A 50VDC CIRCUIT - VAC MOTOR	86001910 / EA-29
MINUTEMAN	741005	SWITCH,KEY 56441538	86612660 / EAL-1
MINUTEMAN	741135	SWITCH,KEY 56441538	86612660 / EAL-1
MINUTEMAN	741137	LIGHT PILOT	86606330 / CPL-1
MINUTEMAN	741502	GUIDE	86637410 / FM-1
MINUTEMAN	742002	BALL VALVE, 3/8", 1/4 TURN	86607880 / VC-60
MINUTEMAN	742201	SOLENOID -STARTER 12V	86891370 / PB-165
MINUTEMAN	742204	YELLOW 175 SB PLUGS	86634020 / CHP-3-Y
MINUTEMAN	742266	CIRCUIT BREAKER-60 AMP	86608900 / EA-71
MINUTEMAN	742709	PUMP 36V	86707290

OEM Interchange

Visit our website for the most current and complete OEM interchange



OEM	OEM Part #	Material Description	Graco Part # / Old Graco#
MINUTEMAN	742714	MOTOR 1 HP W/GEARBOX,45036B	86609160 / F755401
MINUTEMAN	762084	SPRING-HANDLE 56328790	86608680 / SPA-2000
MINUTEMAN	762100	SWITCH	86634620 / EA-32
MINUTEMAN	762332	8"x1 5/8" RUBBER WHEEL (QBA) W/3/4 BRGS(86608740 / WA-5
MINUTEMAN	762333	WHEEL CASTER 56206725	86608720 / WA-3
MINUTEMAN	808829	BUMPER WHEEL	86618540 / WA-10
MINUTEMAN	809282	GASKET-CLEANOUT DOOR	86620360 / HK-G-1
MINUTEMAN	809393	BLADE, TAN GUM 2"x1/4"x31" - 13 Holes	86843330 / MC-24-3C
MINUTEMAN	809395	BLADE, GUM 2"x1/4"x28-3/4" - 13 Holes	86843160 / MC-21-3A
MINUTEMAN	809397	BLADE, GUM 1-1/2"x1/8"x29"	86843170 / MC-21-3B
MINUTEMAN	809413	BALL VALVE, 3/8", 1/4 TURN	86607880 / VC-60
MINUTEMAN	809528	BLADE, TAN GUM 1-1/2"x1/8"x40" -15 Holes	86843480 / MC-32-3B
MINUTEMAN	809532	BLADE, TAN GUM 1-7/8"x3/16"x37-3/8" -14	86843470 / MC-32-3A
MINUTEMAN	809754	SWITCH	86652590 / ETN-1
MINUTEMAN	827060	SWITCH-TOGGLE,47384C, 827060	86605870 / EC-88
MINUTEMAN	827110	5" POLY SWIVEL CASTER(F) (QBA)	86606110 / WC-3
MINUTEMAN	829757	PUMP	86694440 / M-42
MINUTEMAN	830932	SWITCH - LIFT & LOWER MPW-40	86617090 / EA-21
MINUTEMAN	831472	BLADE, GUM 1-7/8"x3/16"x29-1/2" -12 Hls,	86841110 / HMC-24-3C
MINUTEMAN	831473	SQUEEGEE	86693600 / HMC-32-3C
MINUTEMAN	831524	3STAGE VACCUUM MOTOR	86620570 / VM-28
MINUTEMAN	832947	BEARING, BALL (6205-2RS)	86626370 / MC-1-B
MINUTEMAN	833067	SHURFLO PUMP	86717350 / M-104
MINUTEMAN	833299	PUMP.100PSI-24V	86621720 / M-107
MINUTEMAN	833316	DRAIN PLUG 1 1/4"	86006240 / VA-7
MINUTEMAN	833379	3/4 H.P. BRUSH MOTOR	86609140 / F732775
MINUTEMAN	833474	CARBON BRUSH 833474	86623310 / F732775-1
MINUTEMAN	833842	BLADE, NEO 2"x3/16"x39-3/4" -15 Holes (r	86841240 / HMC-32-3AN
MINUTEMAN	833843	BLADE, NEO 2"x3/16"x39-3/4" -15 Holes (r	86841240 / HMC-32-3AN
MINUTEMAN	833847	BLADE, NEO 1-7/8"x3/16"x37-1/2"-14 Hls,1	86841270 / HMC-32-3CN
MINUTEMAN	911460	SOLENOID 36V.56395452,	86606490 / EC-43
MINUTEMAN	911490	SOLENOID 36V.56395452,	86606490 / EC-43
MINUTEMAN	957710	CHARGER 12V	86717090 / CH-44
MINUTEMAN	957722	24V CHARGER	86719690 / CH-3650G
MINUTEMAN	957751	FUSE	86609530 / CPT-7996
MINUTEMAN	957904	AMMETER (2000S)	86637310 / CHP-10
MINUTEMAN	742718-1	SOLUTION VALVE	86702890 / VTN-7
MINUTEMAN	742772-1	36 VOLT 3 STAGE VAC MOTOR	86854650 / VM-280
MINUTEMAN	809413MCH	BALL VALVE, 3/8", 1/4 TURN	86607880 / VC-60
MINUTEMAN	94-071	BLADE, NEO 1-3/16"x1/8"x39-3/4" - 11 Hol	86841060 / HK-50-B
MINUTEMAN	94-072	BLADE, GUM 1-1/2"x1/8"x36-1/2" - 11 Hole	86841050 / HK-50-A
MINUTEMAN	94-073	BLADE, NEO 1-1/4"x1/8"x28-3/4" - 11 Hole	86841070 / HK-50-C
MINUTEMAN	94-074	BLADE, NEO 1-1/16"x1/16"x28-1/2" - 11 Hol	86841080 / HK-50-D
NILFISK - ADVANCE /AMERICAN LINCOLN / CLARKE / KENT	82312	Valve 36VDC SOL.1/2" HOSEBARB	86009710 / VVN-2
NILFISK - ADVANCE /AMERICAN LINCOLN / CLARKE / KENT	160613	(k)VAC HOSE 30" W/CUFFS	98481460 / VHN-1
NILFISK - ADVANCE /AMERICAN LINCOLN / CLARKE / KENT	168324	BRUSH SPRING (DU-8, SR-7)	86850680 / SC-8
NILFISK - ADVANCE /AMERICAN LINCOLN / CLARKE / KENT	180162	RECTIFIER	86637340 / EA-62
NILFISK - ADVANCE /AMERICAN LINCOLN / CLARKE / KENT	180163	RECTIFIER	86637340 / EA-62
NILFISK - ADVANCE /AMERICAN LINCOLN / CLARKE / KENT	198078	INLET FILTER	86652530 / FC-62
NILFISK - ADVANCE /AMERICAN LINCOLN / CLARKE / KENT	222467	5" POLY SWIVEL CASTER(F) (QBA)	86606110 / WC-3

Visit our website for the most current and complete OEM interchange



OEM	OEM Part #	Material Description	Graco Part # / Old Graco#
NILFISK - ADVANCE /AMERICAN LINCOLN / CLARKE / KENT	222515	5" POLY SWIVEL CASTER(F) (QBA)	86606110 / WC-3
NILFISK - ADVANCE /AMERICAN LINCOLN / CLARKE / KENT	311961	SWITCH BRUSH	86606590 / EA-8
NILFISK - ADVANCE /AMERICAN LINCOLN / CLARKE / KENT	414018	CIRCUIT BREAKER-60 AMP	86608900 / EA-71
NILFISK - ADVANCE /AMERICAN LINCOLN / CLARKE / KENT	419702	BUMPER WHEEL (F) 2 1/2 x 3/4	86603320 / WA-7
NILFISK - ADVANCE /AMERICAN LINCOLN / CLARKE / KENT	419752	4X1 WHEEL	86855670 / WC-23
NILFISK - ADVANCE /AMERICAN LINCOLN / CLARKE / KENT	442473	DRIVE COUPLER	86637400 / BLC-40
NILFISK - ADVANCE /AMERICAN LINCOLN / CLARKE / KENT	448507	SWITCH	86619930 / EA-60
NILFISK - ADVANCE /AMERICAN LINCOLN / CLARKE / KENT	466616	CLUTCH PLATE, METAL (QBA) (P3A) 8/07	86845480 / P-200
NILFISK - ADVANCE /AMERICAN LINCOLN / CLARKE / KENT	500342	ARM, ADJUSTING LINK	86637370 / FM-3
NILFISK - ADVANCE /AMERICAN LINCOLN / CLARKE / KENT	501346	BOLT (F)	86839840 / FM-4
NILFISK - ADVANCE /AMERICAN LINCOLN / CLARKE / KENT	501440	(k) CAM ASSY-FM (ASSEMBLED)	98480510 / FM-7
NILFISK - ADVANCE /AMERICAN LINCOLN / CLARKE / KENT	502404	COUPLING, FM SERIES	86637390 / BLC-30
NILFISK - ADVANCE /AMERICAN LINCOLN / CLARKE / KENT	502407	COUPLING, FM SERIES	86637390 / BLC-30
NILFISK - ADVANCE /AMERICAN LINCOLN / CLARKE / KENT	502460	DRIVE COUPLER	86637400 / BLC-40
NILFISK - ADVANCE /AMERICAN LINCOLN / CLARKE / KENT	503940	(k) CAM ASSY-FM (ASSEMBLED)	98480510 / FM-7
NILFISK - ADVANCE /AMERICAN LINCOLN / CLARKE / KENT	503942	HANDLE-CAM	86637420 / FM-6
NILFISK - ADVANCE /AMERICAN LINCOLN / CLARKE / KENT	505140	LEVER SWITCH (TRIGGER)	86637450 / FM-2
NILFISK - ADVANCE /AMERICAN LINCOLN / CLARKE / KENT	505169	(k) PUMP, 115v(Fan Cooled) (QBA) 100PSI	98480570 / M-43
NILFISK - ADVANCE /AMERICAN LINCOLN / CLARKE / KENT	508641	SOLUTION TANK, BUFFER	86000620 / MC-3500
NILFISK - ADVANCE /AMERICAN LINCOLN / CLARKE / KENT	600370	BULK GASKET 1/4 X 1/2 X 50 (PER FT)	86618530 / AG-3-B
NILFISK - ADVANCE /AMERICAN LINCOLN / CLARKE / KENT	607003	24V VAC MOTOR (QBA) (116155-00)	86601190 / VM-1
NILFISK - ADVANCE /AMERICAN LINCOLN / CLARKE / KENT	620972	BRUSH MECH. EA. (33326-1 REPL 33308)	86801380
NILFISK - ADVANCE /AMERICAN LINCOLN / CLARKE / KENT	623320	FILTER	86839670 / FC-25
NILFISK - ADVANCE /AMERICAN LINCOLN / CLARKE / KENT	623382	Filter VAC MOTOR	86003510 / FA-1
NILFISK - ADVANCE /AMERICAN LINCOLN / CLARKE / KENT	625242	120 VOLT VAC MOTOR	86854990 / VM-6
NILFISK - ADVANCE /AMERICAN LINCOLN / CLARKE / KENT	625273	120 VOLT VAC MOTOR	86854990 / VM-6
NILFISK - ADVANCE /AMERICAN LINCOLN / CLARKE / KENT	628520	SCREEN VAC.INTAKE	86606440 / FC-4
NILFISK - ADVANCE /AMERICAN LINCOLN / CLARKE / KENT	635225	VAC MOTOR, (QBA) 7.2",DB,2 STG, TYPE D P	86855060 / VM-9
NILFISK - ADVANCE /AMERICAN LINCOLN / CLARKE / KENT	643412	VACUUM MOTOR GASKET	86839430 / FB2496
NILFISK - ADVANCE /AMERICAN LINCOLN / CLARKE / KENT	643418	VACUUM MOTOR GASKET	86839430 / FB2496
NILFISK - ADVANCE /AMERICAN LINCOLN / CLARKE / KENT	655207	120 VOLT VAC MOTOR	86855020 / VM-7
NILFISK - ADVANCE /AMERICAN LINCOLN / CLARKE / KENT	655210	120 VOLT VAC MOTOR	86855020 / VM-7
NILFISK - ADVANCE /AMERICAN LINCOLN / CLARKE / KENT	660638	PAPER BAG (3 PACK) (QBA)	86848300 / PBC-300
NILFISK - ADVANCE /AMERICAN LINCOLN / CLARKE / KENT	662731	BRUSH ASSY.HEX END	86633530 / BRE-2
NILFISK - ADVANCE /AMERICAN LINCOLN / CLARKE / KENT	663032	FAN, LEXAN	86711430 / FE-1
NILFISK - ADVANCE /AMERICAN LINCOLN / CLARKE / KENT	663430	GASKET	86647890 / VCP-39
NILFISK - ADVANCE /AMERICAN LINCOLN / CLARKE / KENT	665291	120 VOLT VAC MOTOR	86855020 / VM-7
NILFISK - ADVANCE /AMERICAN LINCOLN / CLARKE / KENT	666635	BOTTOM PLATE	86659480 / VCP-16
NILFISK - ADVANCE /AMERICAN LINCOLN / CLARKE / KENT	673312	FILTER	86839680 / FC-35
NILFISK - ADVANCE /AMERICAN LINCOLN / CLARKE / KENT	674114	(k)1 1/2"X10"VAC. HOSE RED	98480780 / M130-10R
NILFISK - ADVANCE /AMERICAN LINCOLN / CLARKE / KENT	675216	120V,12.7 AMP,2 STAGE VACUUM MTR. (QBA)	86854410 / VM-12
NILFISK - ADVANCE /AMERICAN LINCOLN / CLARKE / KENT	675219	120V,12.7 AMP,2 STAGE VACUUM MTR. (QBA)	86854410 / VM-12
NILFISK - ADVANCE /AMERICAN LINCOLN / CLARKE / KENT	680724	SQUEEGEE SET	86830770 / C-14T-5
NILFISK - ADVANCE /AMERICAN LINCOLN / CLARKE / KENT	699402	DRAIN VALVE	86634390 / VC-72
NILFISK - ADVANCE /AMERICAN LINCOLN / CLARKE / KENT	703301	FILTER FOAM PAD	86606190 / FC-1
NILFISK - ADVANCE /AMERICAN LINCOLN / CLARKE / KENT	733441	GASKET (933) (QBA)	86831840 / C-G-33
NILFISK - ADVANCE /AMERICAN LINCOLN / CLARKE / KENT	733442	GASKET	86723890 / VC-72-G
NILFISK - ADVANCE /AMERICAN LINCOLN / CLARKE / KENT	737140	DISCONNECT(MALE 1/8" SHUT (QBA)	86849060 / PW-2
NILFISK - ADVANCE /AMERICAN LINCOLN / CLARKE / KENT	737141	DISCONNECT(FEMALE 1/8"SHU (QBA)	86849050 / PW-1
NILFISK - ADVANCE /AMERICAN LINCOLN / CLARKE / KENT	739444	DRAIN VALVE	86634390 / VC-72

Visit our website for the most current and complete OEM interchange



OEM	OEM Part #	Material Description	Graco Part # / Old Graco#
NILFISK - ADVANCE /AMERICAN LINCOLN / CLARKE / KENT	740705	CORD, (QBA) 50' ORANGE EXTENSION (16/3 S	86833140 / E-651
NILFISK - ADVANCE /AMERICAN LINCOLN / CLARKE / KENT	740801	SWITCH-BRUSH,47381A(1 1/2"L x 1"W)	86608080 / EA-36
NILFISK - ADVANCE /AMERICAN LINCOLN / CLARKE / KENT	741203	BATTERY CABLE	86827690 / BC421B
NILFISK - ADVANCE /AMERICAN LINCOLN / CLARKE / KENT	741204	BATTERY CABLE	86827700 / BC421R
NILFISK - ADVANCE /AMERICAN LINCOLN / CLARKE / KENT	741501	BOLT (F)	86839840 / FM-4
NILFISK - ADVANCE /AMERICAN LINCOLN / CLARKE / KENT	743850	GUIDE	86637410 / FM-1
NILFISK - ADVANCE /AMERICAN LINCOLN / CLARKE / KENT	769741	4"CASTER WHEEL W/STEM (QBA) (F)	86608480 / WC-4
NILFISK - ADVANCE /AMERICAN LINCOLN / CLARKE / KENT	769744	4"CASTER WHEEL W/STEM (QBA) (F)	86608480 / WC-4
NILFISK - ADVANCE /AMERICAN LINCOLN / CLARKE / KENT	800552	SIDE APRON (QBA)	86831860 / C-G-5
NILFISK - ADVANCE /AMERICAN LINCOLN / CLARKE / KENT	800750	BLADE, NEO (QBA) 2-1/4"x3/16"x30-5/8" -9	86831140 / C-24-3B
NILFISK - ADVANCE /AMERICAN LINCOLN / CLARKE / KENT	800751	BLADE, BLACK (QBA) C.I. 2-1/8"x1/8"x28"	86831150 / C-24-3C
NILFISK - ADVANCE /AMERICAN LINCOLN / CLARKE / KENT	800752	BLADE, TAN GUM (QBA) 30-3/4" Long - 9 Ho	86606070 / C-24-3A
NILFISK - ADVANCE /AMERICAN LINCOLN / CLARKE / KENT	800967	MOTOR BRUSH	86666440 / EC-30
NILFISK - ADVANCE /AMERICAN LINCOLN / CLARKE / KENT	802251	MOTOR-BRUSH 45037A	86606340 / MTC-2
NILFISK - ADVANCE /AMERICAN LINCOLN / CLARKE / KENT	802450	(k) CHAIN (#40 X 32-3/4")	98480200 / BLC-7
NILFISK - ADVANCE /AMERICAN LINCOLN / CLARKE / KENT	802456	36V CHARGER	86632210 / CH-7
NILFISK - ADVANCE /AMERICAN LINCOLN / CLARKE / KENT	802465	36V CHARGER	86632210 / CH-7
NILFISK - ADVANCE /AMERICAN LINCOLN / CLARKE / KENT	802953	END BELL (PEERLESS)	86843110 / MC-1-E
NILFISK - ADVANCE /AMERICAN LINCOLN / CLARKE / KENT	804545	4X1 WHEEL	86855670 / WC-23
NILFISK - ADVANCE /AMERICAN LINCOLN / CLARKE / KENT	805250	MOTOR-BRUSH 45037A	86606340 / MTC-2
NILFISK - ADVANCE /AMERICAN LINCOLN / CLARKE / KENT	805251	MOTOR-BRUSH 45037A	86606340 / MTC-2
NILFISK - ADVANCE /AMERICAN LINCOLN / CLARKE / KENT	805254	MOTOR, TRAVERSE 805254	86606360 / MTC-1
NILFISK - ADVANCE /AMERICAN LINCOLN / CLARKE / KENT	805263	MOTOR-BRUSH 45037A	86606340 / MTC-2
NILFISK - ADVANCE /AMERICAN LINCOLN / CLARKE / KENT	805264	MOTOR-BRUSH 45037A	86606340 / MTC-2
NILFISK - ADVANCE /AMERICAN LINCOLN / CLARKE / KENT	805266	MOTOR-BRUSH 45037A	86606340 / MTC-2
NILFISK - ADVANCE /AMERICAN LINCOLN / CLARKE / KENT	805267	MOTOR-BRUSH 45037A	86606340 / MTC-2
NILFISK - ADVANCE /AMERICAN LINCOLN / CLARKE / KENT	809059	TUBE ONLY	86606640 / WC-2
NILFISK - ADVANCE /AMERICAN LINCOLN / CLARKE / KENT	809256	STRAIN RELIEF	86832200 / CHP-15
NILFISK - ADVANCE /AMERICAN LINCOLN / CLARKE / KENT	809406	BALL VALVE, 3/8", 1/4 TURN	86607880 / VC-60
NILFISK - ADVANCE /AMERICAN LINCOLN / CLARKE / KENT	810780	BLADE, C.I. (QBA) NEO BACKUP 2-1/8"x1/8"	86830810 / C-16-3C
NILFISK - ADVANCE /AMERICAN LINCOLN / CLARKE / KENT	810781	BLADE, GUM (QBA) 2-1/2"x3/16"x19-5/8" -	86830790 / C-16-3A
NILFISK - ADVANCE /AMERICAN LINCOLN / CLARKE / KENT	810782	BLADE, NEO (QBA) 1-1/2"x3/16"x19-5/8" -5	86830800 / C-16-3B
NILFISK - ADVANCE /AMERICAN LINCOLN / CLARKE / KENT	820720	BLADE, NEO (QBA) 1-5/8"x1/4"x25" - 7 Hol	86830960 / C-21-3B
NILFISK - ADVANCE /AMERICAN LINCOLN / CLARKE / KENT	829404	BALL VALVE, 3/8", 1/4 TURN	86607880 / VC-60
NILFISK - ADVANCE /AMERICAN LINCOLN / CLARKE / KENT	830701	BLADE, TAN GUM (QBA) 30-1/2" Lo	86606750 / C-60-3A
NILFISK - ADVANCE /AMERICAN LINCOLN / CLARKE / KENT	830702	BLADE, NEO (QBA) 2-1/8"x3/16"x31" - 9 Ho	86606760 / C-60-3B
NILFISK - ADVANCE /AMERICAN LINCOLN / CLARKE / KENT	830703	BLADE, BLACK (QBA) C.I. 1-1/4"x1/8"x28"	86606770 / C-60-3C
NILFISK - ADVANCE /AMERICAN LINCOLN / CLARKE / KENT	830704	BLADE-SQUEEGEE BA	86639660 / C-80-3B
NILFISK - ADVANCE /AMERICAN LINCOLN / CLARKE / KENT	830705	BLADE SQ.FRONT (80-3200)	86606800 / C-80-3C
NILFISK - ADVANCE /AMERICAN LINCOLN / CLARKE / KENT	830706	BLADE, TAN GUM (QBA) 2-1/2"x1/4"x37"- 17	86606780 / C-80-3A
NILFISK - ADVANCE /AMERICAN LINCOLN / CLARKE / KENT	830707	BLADE, (QBA) RIDGED URETHANE 1-5/8"x1/8"	86831040 / C-2400-3C
NILFISK - ADVANCE /AMERICAN LINCOLN / CLARKE / KENT	830708	BLADE, (QBA) RIDGED URETHANE 1-5/8"x1/8"	86831310 / C-3200-3C
NILFISK - ADVANCE /AMERICAN LINCOLN / CLARKE / KENT	830846	MOTOR END	86606180 / MC-1-EI
NILFISK - ADVANCE /AMERICAN LINCOLN / CLARKE / KENT	830925	CARBON BRUSH 833474	86623310 / F732775-1
NILFISK - ADVANCE /AMERICAN LINCOLN / CLARKE / KENT	832402	(k) DRIVE CHAIN (#40 X 37")	98480180 / BLC-60
NILFISK - ADVANCE /AMERICAN LINCOLN / CLARKE / KENT	832408	BATTERY CABLE (QBA)	86827880 / BCSN412
NILFISK - ADVANCE /AMERICAN LINCOLN / CLARKE / KENT	832409	BATTERY CABLE	86827720 / BC425R
NILFISK - ADVANCE /AMERICAN LINCOLN / CLARKE / KENT	832410	HOSE-SOL.TANK 834102	86607220 / VHC-64
NILFISK - ADVANCE /AMERICAN LINCOLN / CLARKE / KENT	832416	(k) CHAIN DRIVE	98480080 / BLC-42
NILFISK - ADVANCE /AMERICAN LINCOLN / CLARKE / KENT	833201	FRAME SQUEEGEE LH	86606960 / MC-2400-FL

Visit our website for the most current and complete OEM interchange



OEM	OEM Part #	Material Description	Graco Part # / Old Graco#
NILFISK - ADVANCE /AMERICAN LINCOLN / CLARKE / KENT	833301	FLOAT-LEADER 833301	86607050 / FC-6
NILFISK - ADVANCE /AMERICAN LINCOLN / CLARKE / KENT	833308	FILTER-VAC 833308	86607020 / FC-60
NILFISK - ADVANCE /AMERICAN LINCOLN / CLARKE / KENT	833401	GASKET-DRAIN VALVE 833407	86607060 / C-G-63
NILFISK - ADVANCE /AMERICAN LINCOLN / CLARKE / KENT	833402	GASKET-FILTER 833402	86607070 / C-G-60
NILFISK - ADVANCE /AMERICAN LINCOLN / CLARKE / KENT	833403	GASKET - FLOAT,ROUND	86607080 / C-G-61
NILFISK - ADVANCE /AMERICAN LINCOLN / CLARKE / KENT	833407	GASKET-DRAIN VALVE 833407	86607060 / C-G-63
NILFISK - ADVANCE /AMERICAN LINCOLN / CLARKE / KENT	833408	GASKET-VAC.CHAMBER 34220B	86607100 / C-G-80
NILFISK - ADVANCE /AMERICAN LINCOLN / CLARKE / KENT	833802	GIMBAL-BRUSH	86607120 / SC-82
NILFISK - ADVANCE /AMERICAN LINCOLN / CLARKE / KENT	834102	HOSE-SOL.TANK 834102	86607220 / VHC-64
NILFISK - ADVANCE /AMERICAN LINCOLN / CLARKE / KENT	835201	MOTOR-BRUSH 45037A	86606340 / MTC-2
NILFISK - ADVANCE /AMERICAN LINCOLN / CLARKE / KENT	835202	MOTOR-BRUSH 45037A	86606340 / MTC-2
NILFISK - ADVANCE /AMERICAN LINCOLN / CLARKE / KENT	835203	MOTOR,TRAVERSE 805254	86606360 / MTC-1
NILFISK - ADVANCE /AMERICAN LINCOLN / CLARKE / KENT	835204	36V DC VAC MTR (QBA) (116158-00)	86607400 / VM-20
NILFISK - ADVANCE /AMERICAN LINCOLN / CLARKE / KENT	835206	MOTOR,TRAVERSE 805254	86606360 / MTC-1
NILFISK - ADVANCE /AMERICAN LINCOLN / CLARKE / KENT	835207	MOTOR-BRUSH 45037A	86606340 / MTC-2
NILFISK - ADVANCE /AMERICAN LINCOLN / CLARKE / KENT	835208	MOTOR-BRUSH 45037A	86606340 / MTC-2
NILFISK - ADVANCE /AMERICAN LINCOLN / CLARKE / KENT	835209	MOTOR,TRAVERSE 805254	86606360 / MTC-1
NILFISK - ADVANCE /AMERICAN LINCOLN / CLARKE / KENT	835215	MOTOR,TRAVERSE 805254	86606360 / MTC-1
NILFISK - ADVANCE /AMERICAN LINCOLN / CLARKE / KENT	838302	SPRING SQUEEGEE 838302	86607630 / SC-80
NILFISK - ADVANCE /AMERICAN LINCOLN / CLARKE / KENT	838517	INLET FILTER	86652530 / FC-62
NILFISK - ADVANCE /AMERICAN LINCOLN / CLARKE / KENT	839402	VALVE-EXHAUST	86607860 / VC-69
NILFISK - ADVANCE /AMERICAN LINCOLN / CLARKE / KENT	839403	BALL VALVE, 3/8", 1/4 TURN	86607880 / VC-60
NILFISK - ADVANCE /AMERICAN LINCOLN / CLARKE / KENT	839705	(k) COMPLETE-DRIVE WHEEL & AXLE	98481280 / WC-5-A
NILFISK - ADVANCE /AMERICAN LINCOLN / CLARKE / KENT	839706	5" POLY SWIVEL CASTER(F) (QBA)	86606110 / WC-3
NILFISK - ADVANCE /AMERICAN LINCOLN / CLARKE / KENT	842405	BATTERY CABLE	86827720 / BC425R
NILFISK - ADVANCE /AMERICAN LINCOLN / CLARKE / KENT	842406	BATTERY CABLE (QBA)	86827880 / BCSN412
NILFISK - ADVANCE /AMERICAN LINCOLN / CLARKE / KENT	848506	SOLENOID 36V.6POLE 788147	86607790 / EC-81
NILFISK - ADVANCE /AMERICAN LINCOLN / CLARKE / KENT	849401	BALL VALVE, 3/8", 1/4 TURN	86607880 / VC-60
NILFISK - ADVANCE /AMERICAN LINCOLN / CLARKE / KENT	850701	SQUEEGEE BLADE (NEO) (QBA)	86831670 / C-860-5C
NILFISK - ADVANCE /AMERICAN LINCOLN / CLARKE / KENT	850702	SQUEEGEE BLADE (GUM) (QBA)	86831650 / C-860-5A
NILFISK - ADVANCE /AMERICAN LINCOLN / CLARKE / KENT	850703	SQUEEGEE BLADE (C.I.) (QBA)	86831680 / C-860-5D
NILFISK - ADVANCE /AMERICAN LINCOLN / CLARKE / KENT	850741	BLADE, GUM (QBA) 3-1/4"x1/4"x49-1/2" - 1	86831530 / C-42-2A
NILFISK - ADVANCE /AMERICAN LINCOLN / CLARKE / KENT	850742	BLADE, C.I. (QBA) NEO 2-1/4"x1/8"x49-1/2	86831540 / C-42-2B
NILFISK - ADVANCE /AMERICAN LINCOLN / CLARKE / KENT	858502	SQUEEGEE BLADE (GUM) (QBA)	86831660 / C-860-5B
NILFISK - ADVANCE /AMERICAN LINCOLN / CLARKE / KENT	870760	BLADE, BLACK (QBA) C.I. BACKUP 2-3/8"x1/	86830970 / C-21-3C
NILFISK - ADVANCE /AMERICAN LINCOLN / CLARKE / KENT	870761	BLADE, TAN GUM (QBA) 2-3/4"x3/16"25" -7	86830950 / C-21-3A
NILFISK - ADVANCE /AMERICAN LINCOLN / CLARKE / KENT	870762	BLADE, NEO (QBA) 1-5/8"x1/4"x25" - 7 Hol	86830960 / C-21-3B
NILFISK - ADVANCE /AMERICAN LINCOLN / CLARKE / KENT	870962	MOTOR BRUSH	86666440 / EC-30
NILFISK - ADVANCE /AMERICAN LINCOLN / CLARKE / KENT	872461	(k) CHAIN (#35 X 20-3/4")	98480160 / BLC-4
NILFISK - ADVANCE /AMERICAN LINCOLN / CLARKE / KENT	872468	CHARGER 24V, 25A	86632050 / CH-8
NILFISK - ADVANCE /AMERICAN LINCOLN / CLARKE / KENT	873403	GASKET,VACUUM 873403	86606240 / C-G-1
NILFISK - ADVANCE /AMERICAN LINCOLN / CLARKE / KENT	875204	24V VAC MOTOR (QBA) (116155-00)	86601190 / VM-1
NILFISK - ADVANCE /AMERICAN LINCOLN / CLARKE / KENT	878514	SOLENOID 24 VOLT 878514,788147	86606480 / EC-1
NILFISK - ADVANCE /AMERICAN LINCOLN / CLARKE / KENT	878535	STRAINER, ROUND 5/8" OPENING	86606580 / FC-2
NILFISK - ADVANCE /AMERICAN LINCOLN / CLARKE / KENT	879216	TIMER 12 HR. W/O KNOB (KNOB PART# 02003)	86832190 / CHP-14
NILFISK - ADVANCE /AMERICAN LINCOLN / CLARKE / KENT	879264	TIMER 12 HR. W/O KNOB (KNOB PART# 02003)	86832190 / CHP-14
NILFISK - ADVANCE /AMERICAN LINCOLN / CLARKE / KENT	882406	(k) CHAIN	98480110 / BLC-13
NILFISK - ADVANCE /AMERICAN LINCOLN / CLARKE / KENT	882411	CHARGER 24V, 25A	86632050 / CH-8
NILFISK - ADVANCE /AMERICAN LINCOLN / CLARKE / KENT	882420	BATTERY CABLE (QBA)	86827880 / BCSN412
NILFISK - ADVANCE /AMERICAN LINCOLN / CLARKE / KENT	882423	BATTERY CABLE	86827700 / BC421R

Visit our website for the most current and complete OEM interchange



OEM	OEM Part #	Material Description	Graco Part # / Old Graco#
NILFISK - ADVANCE /AMERICAN LINCOLN / CLARKE / KENT	883351	GREASE FITTING(F)	86855870 / WC-5-Z
NILFISK - ADVANCE /AMERICAN LINCOLN / CLARKE / KENT	883408	GASKET-CLEAN OUT FLANGE 883408	86606250 / C-G-4
NILFISK - ADVANCE /AMERICAN LINCOLN / CLARKE / KENT	883410	GASKET-DRAIN DOOR 883410	86606220 / C-G-3
NILFISK - ADVANCE /AMERICAN LINCOLN / CLARKE / KENT	884106	(k) VACUUM HOSE ASSEMBLY (VHC-3)	98481110 / VHC-3
NILFISK - ADVANCE /AMERICAN LINCOLN / CLARKE / KENT	886602	PLASTIC PAD HOLDER	86607420 / PH-2-P
NILFISK - ADVANCE /AMERICAN LINCOLN / CLARKE / KENT	889406	VALVE 2 WAY	86620130 / VA-4
NILFISK - ADVANCE /AMERICAN LINCOLN / CLARKE / KENT	889706	4"CASTER WHEEL W/STEM (QBA) (F)	86608480 / WC-4
NILFISK - ADVANCE /AMERICAN LINCOLN / CLARKE / KENT	890554	AXLE FOR WA-1	86855330 / WA-1-A
NILFISK - ADVANCE /AMERICAN LINCOLN / CLARKE / KENT	890701	BLADE, C.I. (QBA) BLACK 2-1/4"x1/8"x35"	86831350 / C-32-3C
NILFISK - ADVANCE /AMERICAN LINCOLN / CLARKE / KENT	890702	BLADE, TAN GUM (QBA) 2"x3/16"x41-5/16" -	86831330 / C-32-3A
NILFISK - ADVANCE /AMERICAN LINCOLN / CLARKE / KENT	890950	CARBON BRUSH	86834270 / EC-31
NILFISK - ADVANCE /AMERICAN LINCOLN / CLARKE / KENT	890956	CARBON BRUSH (F)	86834280 / EC-33
NILFISK - ADVANCE /AMERICAN LINCOLN / CLARKE / KENT	890970	CARBON BRUSH	86623320 / EC-44
NILFISK - ADVANCE /AMERICAN LINCOLN / CLARKE / KENT	892411	BATTERY CABLE	86827690 / BC421B
NILFISK - ADVANCE /AMERICAN LINCOLN / CLARKE / KENT	892452	(k) CHAIN (#40 X 31-3/4")	98480100 / BLC-10
NILFISK - ADVANCE /AMERICAN LINCOLN / CLARKE / KENT	892453	BATTERY CABLE	86827700 / BC421R
NILFISK - ADVANCE /AMERICAN LINCOLN / CLARKE / KENT	893401	GASKET FLOAT CAGE	86606270 / C-G-2
NILFISK - ADVANCE /AMERICAN LINCOLN / CLARKE / KENT	893450	GASKET - TUBE INSPECTION	86606260 / C-G-8
NILFISK - ADVANCE /AMERICAN LINCOLN / CLARKE / KENT	893454	GASKET - TUBE INSPECTION	86606260 / C-G-8
NILFISK - ADVANCE /AMERICAN LINCOLN / CLARKE / KENT	895101	#35 LINK CONN.895101	86633930 / BLC-35
NILFISK - ADVANCE /AMERICAN LINCOLN / CLARKE / KENT	895158	40 LINK,CONN.	86633920 / BLAL-9
NILFISK - ADVANCE /AMERICAN LINCOLN / CLARKE / KENT	895250	MOTOR,TRAVERSE 805254	86606360 / MTC-1
NILFISK - ADVANCE /AMERICAN LINCOLN / CLARKE / KENT	895251	36V 2 STAGE VAC MTR (QBA) (116156-00)	86854510 / VM-2
NILFISK - ADVANCE /AMERICAN LINCOLN / CLARKE / KENT	897501	BLADE, NEO (QBA) 2-1/8"x3/16"x37" -11 Ho	86831340 / C-32-3B
NILFISK - ADVANCE /AMERICAN LINCOLN / CLARKE / KENT	898550	SPROCKET-DRIVE MOTOR 898550	86606570 / BLC-16
NILFISK - ADVANCE /AMERICAN LINCOLN / CLARKE / KENT	898572	SPROCKET-DRIVE MOTOR 898550	86606570 / BLC-16
NILFISK - ADVANCE /AMERICAN LINCOLN / CLARKE / KENT	899370	WHEEL FOR WC-3 (QBA)	86606120 / WC-3-W
NILFISK - ADVANCE /AMERICAN LINCOLN / CLARKE / KENT	899707	5" POLY SWIVEL CASTER(F) (QBA)	86606110 / WC-3
NILFISK - ADVANCE /AMERICAN LINCOLN / CLARKE / KENT	899713	5" POLY SWIVEL CASTER(F) (QBA)	86606110 / WC-3
NILFISK - ADVANCE /AMERICAN LINCOLN / CLARKE / KENT	899713	TUBE ONLY	86606640 / WC-2
NILFISK - ADVANCE /AMERICAN LINCOLN / CLARKE / KENT	899714	5" POLY SWIVEL CASTER(F) (QBA)	86606110 / WC-3
NILFISK - ADVANCE /AMERICAN LINCOLN / CLARKE / KENT	899716	5" POLY SWIVEL CASTER(F) (QBA)	86606110 / WC-3
NILFISK - ADVANCE /AMERICAN LINCOLN / CLARKE / KENT	899765	5" POLY SWIVEL CASTER(F) (QBA)	86606110 / WC-3
NILFISK - ADVANCE /AMERICAN LINCOLN / CLARKE / KENT	902051	BEARING	86626340 / MC-23
NILFISK - ADVANCE /AMERICAN LINCOLN / CLARKE / KENT	902298	BEARING	86626340 / MC-23
NILFISK - ADVANCE /AMERICAN LINCOLN / CLARKE / KENT	902512	BEARING	86831690 / CB-10
NILFISK - ADVANCE /AMERICAN LINCOLN / CLARKE / KENT	902550	BEARING	86626340 / MC-23
NILFISK - ADVANCE /AMERICAN LINCOLN / CLARKE / KENT	902561	BEARING	86626340 / MC-23
NILFISK - ADVANCE /AMERICAN LINCOLN / CLARKE / KENT	902567	BEARING	86831690 / CB-10
NILFISK - ADVANCE /AMERICAN LINCOLN / CLARKE / KENT	902603	BEARING, BALL (6205-2RS)	86626370 / MC-1-B
NILFISK - ADVANCE /AMERICAN LINCOLN / CLARKE / KENT	902636	BEARING	86626340 / MC-23
NILFISK - ADVANCE /AMERICAN LINCOLN / CLARKE / KENT	902646	BEARING/BALL	86608810 / AD-B-1
NILFISK - ADVANCE /AMERICAN LINCOLN / CLARKE / KENT	902648	BEARING/BALL	86608810 / AD-B-1
NILFISK - ADVANCE /AMERICAN LINCOLN / CLARKE / KENT	902653	BEARING	86831690 / CB-10
NILFISK - ADVANCE /AMERICAN LINCOLN / CLARKE / KENT	902654	BALL BEARING	86626360 / CB-11
NILFISK - ADVANCE /AMERICAN LINCOLN / CLARKE / KENT	902658	BEARING	86726540 / CB-14
NILFISK - ADVANCE /AMERICAN LINCOLN / CLARKE / KENT	902660	BEARING	86726540 / CB-14
NILFISK - ADVANCE /AMERICAN LINCOLN / CLARKE / KENT	902675	BEARING	86626340 / MC-23
NILFISK - ADVANCE /AMERICAN LINCOLN / CLARKE / KENT	902679	BEARING/BALL	86608810 / AD-B-1
NILFISK - ADVANCE /AMERICAN LINCOLN / CLARKE / KENT	902704	BEARING FOR WA-1	86855340 / WA-1-B

Visit our website for the most current and complete OEM interchange



OEM	OEM Part #	Material Description	Graco Part # / Old Graco#
NILFISK - ADVANCE /AMERICAN LINCOLN / CLARKE / KENT	902713	5/8 FLANGE BEARING ASSY F	86608160 / CFB-1
NILFISK - ADVANCE /AMERICAN LINCOLN / CLARKE / KENT	903015	BELT 45"	86828510 / BLC-21
NILFISK - ADVANCE /AMERICAN LINCOLN / CLARKE / KENT	903018	BELT (TO FIT TB-20-E)	86828570 / BLC-34
NILFISK - ADVANCE /AMERICAN LINCOLN / CLARKE / KENT	903042	DRIVE BELT (578)	86828720 / BLC-78
NILFISK - ADVANCE /AMERICAN LINCOLN / CLARKE / KENT	903340	BELT (QBA)	86600880 / BLE-3
NILFISK - ADVANCE /AMERICAN LINCOLN / CLARKE / KENT	903796	BELT - (QBA) EQUAL TO 903769-9	86828740 / BLC-80
NILFISK - ADVANCE /AMERICAN LINCOLN / CLARKE / KENT	907078	BUFFER CORD 50' 14/3 RED	86617190 / E-452R
NILFISK - ADVANCE /AMERICAN LINCOLN / CLARKE / KENT	907086	14/3 75' RED EXTENSION CORD	86633480 / E-4752R
NILFISK - ADVANCE /AMERICAN LINCOLN / CLARKE / KENT	908275	BUFFER CORD 50' 14/3 RED	86617190 / E-452R
NILFISK - ADVANCE /AMERICAN LINCOLN / CLARKE / KENT	908509	CORD,16/3-25'	86633270 / E-621
NILFISK - ADVANCE /AMERICAN LINCOLN / CLARKE / KENT	908543	CORD,16/3-25'	86633270 / E-621
NILFISK - ADVANCE /AMERICAN LINCOLN / CLARKE / KENT	908684	BUFFER CORD 50' 14/3 RED	86617190 / E-452R
NILFISK - ADVANCE /AMERICAN LINCOLN / CLARKE / KENT	908972	BUFFER CORD 50' 14/3 RED	86617190 / E-452R
NILFISK - ADVANCE /AMERICAN LINCOLN / CLARKE / KENT	911008	AMMETER (2000S)	86637310 / CHP-10
NILFISK - ADVANCE /AMERICAN LINCOLN / CLARKE / KENT	911134	DIODE (POSITIVE)	86637290 / EC-37
NILFISK - ADVANCE /AMERICAN LINCOLN / CLARKE / KENT	911185	S.B. PLUG 50A grey 911185	86634080 / CHP-2
NILFISK - ADVANCE /AMERICAN LINCOLN / CLARKE / KENT	911185	(k) CHARGER PLUG ASSM. W/INSERTS	98480260 / CHP-2-I
NILFISK - ADVANCE /AMERICAN LINCOLN / CLARKE / KENT	911249	SWITCH, TOGGLE	86620060 / EC-39
NILFISK - ADVANCE /AMERICAN LINCOLN / CLARKE / KENT	911287	SWITCH BRUSH	86606590 / EA-8
NILFISK - ADVANCE /AMERICAN LINCOLN / CLARKE / KENT	911388	SWITCH BRUSH	86606590 / EA-8
NILFISK - ADVANCE /AMERICAN LINCOLN / CLARKE / KENT	911456	SWITCH, TOGGLE	86620060 / EC-39
NILFISK - ADVANCE /AMERICAN LINCOLN / CLARKE / KENT	911470	PLUG HOUSING 50A-RED	86634000 / CHP-7-R
NILFISK - ADVANCE /AMERICAN LINCOLN / CLARKE / KENT	911501	BATTERY CABLE	86827760 / BC446R
NILFISK - ADVANCE /AMERICAN LINCOLN / CLARKE / KENT	911516	BATTERY CABLE	86827730 / BC436B
NILFISK - ADVANCE /AMERICAN LINCOLN / CLARKE / KENT	911518	BATTERY CABLE	86827890 / BCSN415
NILFISK - ADVANCE /AMERICAN LINCOLN / CLARKE / KENT	911527	CHERRY SWITCH	86606610 / FB24136
NILFISK - ADVANCE /AMERICAN LINCOLN / CLARKE / KENT	911562	SWITCH - LIFT & LOWER MPW-40	86617090 / EA-21
NILFISK - ADVANCE /AMERICAN LINCOLN / CLARKE / KENT	911602	LIGHT PILOT	86606330 / CPL-1
NILFISK - ADVANCE /AMERICAN LINCOLN / CLARKE / KENT	911606	LIGHT PILOT	86606330 / CPL-1
NILFISK - ADVANCE /AMERICAN LINCOLN / CLARKE / KENT	911630	TOGGLE SWITCH	86607820 / EC-65
NILFISK - ADVANCE /AMERICAN LINCOLN / CLARKE / KENT	911690	SWITCH	86637460 / EC-20
NILFISK - ADVANCE /AMERICAN LINCOLN / CLARKE / KENT	911869	BULB	86606080 / CPL-1B
NILFISK - ADVANCE /AMERICAN LINCOLN / CLARKE / KENT	912019	HEAT SINK ASSM.912212	86637320 / CHP-22
NILFISK - ADVANCE /AMERICAN LINCOLN / CLARKE / KENT	912020	HEAT SINK ASSM.912212	86637320 / CHP-22
NILFISK - ADVANCE /AMERICAN LINCOLN / CLARKE / KENT	912021	AMMETER (2000S)	86637310 / CHP-10
NILFISK - ADVANCE /AMERICAN LINCOLN / CLARKE / KENT	912025	S.B. PLUG 50A grey 911185	86634080 / CHP-2
NILFISK - ADVANCE /AMERICAN LINCOLN / CLARKE / KENT	912026	50 AMP GREY PLUG HOUSING	86634060 / CHP-7-R
NILFISK - ADVANCE /AMERICAN LINCOLN / CLARKE / KENT	912085	RECTIFIER 50A.	86637330 / EC-61
NILFISK - ADVANCE /AMERICAN LINCOLN / CLARKE / KENT	912132	CAPACITOR	86832310 / CHP-2390
NILFISK - ADVANCE /AMERICAN LINCOLN / CLARKE / KENT	912203	LIGHT PILOT	86606330 / CPL-1
NILFISK - ADVANCE /AMERICAN LINCOLN / CLARKE / KENT	912204	SWITCH, TOGGLE	86620060 / EC-39
NILFISK - ADVANCE /AMERICAN LINCOLN / CLARKE / KENT	912212	HEAT SINK ASSM.912212	86637320 / CHP-22
NILFISK - ADVANCE /AMERICAN LINCOLN / CLARKE / KENT	912226	HOUR METER - 12-60VDC ANALOG	86636010 / EC-93
NILFISK - ADVANCE /AMERICAN LINCOLN / CLARKE / KENT	912287	RECTIFIER 50A.	86637330 / EC-61
NILFISK - ADVANCE /AMERICAN LINCOLN / CLARKE / KENT	912300	RAVERSE RESIS obso when stk is gone	86607810 / EC-46
NILFISK - ADVANCE /AMERICAN LINCOLN / CLARKE / KENT	912302	TOGGLE SWITCH	86607830 / EC-64
NILFISK - ADVANCE /AMERICAN LINCOLN / CLARKE / KENT	912313	TOGGLE SWITCH	86607820 / EC-65
NILFISK - ADVANCE /AMERICAN LINCOLN / CLARKE / KENT	912330	BRAKE SWITCH-MICRO, PUSH BUTTON MOMENTAR	86607760 / EC-80
NILFISK - ADVANCE /AMERICAN LINCOLN / CLARKE / KENT	912357	SWITCH-PUSH	86641660 / VCP-2
NILFISK - ADVANCE /AMERICAN LINCOLN / CLARKE / KENT	912382	FUSE-LESTER,56373054	86637300 / CHP-8776

Visit our website for the most current and complete OEM interchange



OEM	OEM Part #	Material Description	Graco Part # / Old Graco#
NILFISK - ADVANCE /AMERICAN LINCOLN / CLARKE / KENT	957764	FUSE HOLDER FRONT	86609740 / CPT-1374
NILFISK - ADVANCE /AMERICAN LINCOLN / CLARKE / KENT	960986	SCREW, SHOULDER	86853330 / VCP-47
NILFISK - ADVANCE /AMERICAN LINCOLN / CLARKE / KENT	2795241	PAD HOLDER	86633830 / PH-3
NILFISK - ADVANCE /AMERICAN LINCOLN / CLARKE / KENT	5603664	BLADE, TAN GUM 4-3/4"x1/8"x29" - 5 Hls/1	86841410 / K-171-1
NILFISK - ADVANCE /AMERICAN LINCOLN / CLARKE / KENT	5604015	SQUEEGEE SET	98485970 / AD-32-4
NILFISK - ADVANCE /AMERICAN LINCOLN / CLARKE / KENT	08602463	SQ BLADE, GUM, FRONT	86619720 / AD-240-2B
NILFISK - ADVANCE /AMERICAN LINCOLN / CLARKE / KENT	08603830	FRONT BLADE	86638050 / 8.685-681.0
NILFISK - ADVANCE /AMERICAN LINCOLN / CLARKE / KENT	08603832	REAR BLADE	86638060 / 8.685-682.0
NILFISK - ADVANCE /AMERICAN LINCOLN / CLARKE / KENT	08603888	Vacuum motor 24VDC 2ST TD	86005440 / VM-29A+
NILFISK - ADVANCE /AMERICAN LINCOLN / CLARKE / KENT	08812930	(K) HOSE VAC 1.5" X 24" W/ CUFFS	98482180 / VHN-2
NILFISK - ADVANCE /AMERICAN LINCOLN / CLARKE / KENT	9022547	BEARING, BALL (6205-2RS)	86626370 / MC-1-B
NILFISK - ADVANCE /AMERICAN LINCOLN / CLARKE / KENT	33017255	BROOM, SIDE POLY	88055550
NILFISK - ADVANCE /AMERICAN LINCOLN / CLARKE / KENT	33018856	BROOM, MAIN NYLON SPIRAL	88055590
NILFISK - ADVANCE /AMERICAN LINCOLN / CLARKE / KENT	33018857	BROOM, MAIN POLY WHITE/NAVY	88055600
NILFISK - ADVANCE /AMERICAN LINCOLN / CLARKE / KENT	33018858	BROOM, MAIN POLY/STEEL	88055580
NILFISK - ADVANCE /AMERICAN LINCOLN / CLARKE / KENT	33018859	BROOM, MAIN UNION MIX SPIRAL	88055610
NILFISK - ADVANCE /AMERICAN LINCOLN / CLARKE / KENT	33018889	BROOM, SIDE POLY/STEEL	88055560
NILFISK - ADVANCE /AMERICAN LINCOLN / CLARKE / KENT	33018890	BROOM, SIDE NYLON	88055570
NILFISK - ADVANCE /AMERICAN LINCOLN / CLARKE / KENT	56003073	BOLT, 5/16-18X1	86895210
NILFISK - ADVANCE /AMERICAN LINCOLN / CLARKE / KENT	56003263	PUSH RIVET, 1/4 BLACK NYLON	86857610
NILFISK - ADVANCE /AMERICAN LINCOLN / CLARKE / KENT	56003268	RING	86703640 / SPA-2
NILFISK - ADVANCE /AMERICAN LINCOLN / CLARKE / KENT	56023371	120 VOLT 2 STAGE VAC MOTOR	86854820 / VM-4
NILFISK - ADVANCE /AMERICAN LINCOLN / CLARKE / KENT	56023867	120 VOLT VAC MOTOR	86855020 / VM-7
NILFISK - ADVANCE /AMERICAN LINCOLN / CLARKE / KENT	56023956	36V 2 STAGE VAC MTR (QBA) (116156-00)	86854510 / VM-2
NILFISK - ADVANCE /AMERICAN LINCOLN / CLARKE / KENT	56024223	VAC MOTOR, (QBA) 7.2",DB,2 STG, TYPE D P	86855060 / VM-9
NILFISK - ADVANCE /AMERICAN LINCOLN / CLARKE / KENT	56024228	MOTOR-BRUSH 45037A	86606340 / MTC-2
NILFISK - ADVANCE /AMERICAN LINCOLN / CLARKE / KENT	56024263	BLADE, TAN GUM 1-7/8"x1/4"x24-3/4"x - 9	86842250 / KM-20-3A
NILFISK - ADVANCE /AMERICAN LINCOLN / CLARKE / KENT	56024264	BLADE, TAN GUM 1-5/8"x1/4"x22" - 9 Holes	86842260 / KM-20-3B
NILFISK - ADVANCE /AMERICAN LINCOLN / CLARKE / KENT	56024265	BLADE, NEO 1-5/8"x1/4"x24-1/4" - 9 Holes	86842270 / KM-20-3C
NILFISK - ADVANCE /AMERICAN LINCOLN / CLARKE / KENT	56024279	120V VACUUM MTR. (QBA) (116325)	86855050 / VM-8
NILFISK - ADVANCE /AMERICAN LINCOLN / CLARKE / KENT	56024331	120 VOLT 3 STAGE VAC MOTOR	86854740 / VM-31
NILFISK - ADVANCE /AMERICAN LINCOLN / CLARKE / KENT	56024373	36V 3-STAGE VAC MOTOR (QBA) (119431-13)	86601200 / VM-24
NILFISK - ADVANCE /AMERICAN LINCOLN / CLARKE / KENT	56024393	SHURFLO 8000 (60 PSI)	86601060 / M-103
NILFISK - ADVANCE /AMERICAN LINCOLN / CLARKE / KENT	56024439	MOTOR/GEAR UNIT	86844120 / MTC-5
NILFISK - ADVANCE /AMERICAN LINCOLN / CLARKE / KENT	56025274	BATTERY CABLE	86827840 / BCS614
NILFISK - ADVANCE /AMERICAN LINCOLN / CLARKE / KENT	56025295	SWITCH,KEY 56441538	86612660 / EAL-1
NILFISK - ADVANCE /AMERICAN LINCOLN / CLARKE / KENT	56025715	CORD,18-3/50' BEIGE	86633290 / VCP-6
NILFISK - ADVANCE /AMERICAN LINCOLN / CLARKE / KENT	56026015	CORD SET,14/3 SJTW-A X 50' YLW	86234110
NILFISK - ADVANCE /AMERICAN LINCOLN / CLARKE / KENT	56026131	AMMETER, DC. 0-75A for 24v & 36V	86600850 / EKM-6
NILFISK - ADVANCE /AMERICAN LINCOLN / CLARKE / KENT	56026412	SWITCH	86601150 / EB-20
NILFISK - ADVANCE /AMERICAN LINCOLN / CLARKE / KENT	56026450	SOLENOID 24 VOLT 878514,788147	86606480 / EC-1
NILFISK - ADVANCE /AMERICAN LINCOLN / CLARKE / KENT	56026504	SOLENOID 36V.56395452,	86606490 / EC-43
NILFISK - ADVANCE /AMERICAN LINCOLN / CLARKE / KENT	56026504	SOLENOID 36V.56395452,	86606490 / EC-43
NILFISK - ADVANCE /AMERICAN LINCOLN / CLARKE / KENT	56026507	RED PIOLT LIGHT	86720770 / KPL-1
NILFISK - ADVANCE /AMERICAN LINCOLN / CLARKE / KENT	56026515	SWITCH	86634190 / EK-5
NILFISK - ADVANCE /AMERICAN LINCOLN / CLARKE / KENT	56026573	S.B. PLUG 50A grey 911185	86634080 / CHP-2
NILFISK - ADVANCE /AMERICAN LINCOLN / CLARKE / KENT	56026603	SWITCH N.C./N.O.(PRES.)	86652610 / EA-31
NILFISK - ADVANCE /AMERICAN LINCOLN / CLARKE / KENT	56026672	PLUG TWIST LOCK - MALE	86633250 / E-78
NILFISK - ADVANCE /AMERICAN LINCOLN / CLARKE / KENT	56026676	CONN. BODY TWIST LOCK	86633240 / E-79
NILFISK - ADVANCE /AMERICAN LINCOLN / CLARKE / KENT	56026699	CIRCUIT BREAKER 20 AMP (QBA)	86609750 / EA-33

Visit our website for the most current and complete OEM interchange



OEM	OEM Part #	Material Description	Graco Part # / Old Graco#
NILFISK - ADVANCE /AMERICAN LINCOLN / CLARKE / KENT	56026713	SOLENOID 36V.6POLE 788147	86607790 / EC-81
NILFISK - ADVANCE /AMERICAN LINCOLN / CLARKE / KENT	56026857	CARBON BRUSH (F) (QBA)	86834410 / EC-51
NILFISK - ADVANCE /AMERICAN LINCOLN / CLARKE / KENT	56027145	VALVE SOLENOID 24VDC	86601210 / VK-3
NILFISK - ADVANCE /AMERICAN LINCOLN / CLARKE / KENT	56035240	36 VOLT 3 STAGE VAC MOTOR	86854650 / VM-280
NILFISK - ADVANCE /AMERICAN LINCOLN / CLARKE / KENT	56035257	PUMP,SHURFLO 12V.56035257	86634170 / M-106
NILFISK - ADVANCE /AMERICAN LINCOLN / CLARKE / KENT	56038373	SWITCH,KEY 56441538	86612660 / EAL-1
NILFISK - ADVANCE /AMERICAN LINCOLN / CLARKE / KENT	56038423	SQUEEGEE SET	98485940 / K-320-5
NILFISK - ADVANCE /AMERICAN LINCOLN / CLARKE / KENT	56038784	RECTIFIER 50A.	86637330 / EC-61
NILFISK - ADVANCE /AMERICAN LINCOLN / CLARKE / KENT	56039065	SQUEEGEE SET	98484770 / K-266N-3
NILFISK - ADVANCE /AMERICAN LINCOLN / CLARKE / KENT	56039066	SQUEEGEE SET-NEW	98484790 / K-326N-3
NILFISK - ADVANCE /AMERICAN LINCOLN / CLARKE / KENT	56039139	SQUEEGEE BLADE SET	98484760 / K-201-3
NILFISK - ADVANCE /AMERICAN LINCOLN / CLARKE / KENT	56039204	SQUEEGEE SET	98485950 / K-381-3
NILFISK - ADVANCE /AMERICAN LINCOLN / CLARKE / KENT	56039566	SQUEEGEE SET	98484740 / K-33-3
NILFISK - ADVANCE /AMERICAN LINCOLN / CLARKE / KENT	56039567	SQUEEGEE SET	98485960 / K-39-3
NILFISK - ADVANCE /AMERICAN LINCOLN / CLARKE / KENT	56039590	SQUEEGEE SET	98484780 / K-27-3
NILFISK - ADVANCE /AMERICAN LINCOLN / CLARKE / KENT	56046834	BLADE, GUM 1-1/2"x1/4"x9-3/8" - 5 Holes	86841440 / K-18-4C
NILFISK - ADVANCE /AMERICAN LINCOLN / CLARKE / KENT	56046835	BLADE, GUM 2"x3/16"x24" -13 Holes	86841430 / K-18-4A
NILFISK - ADVANCE /AMERICAN LINCOLN / CLARKE / KENT	56046836	BLADE, GUM 1-1/2"x1/8"x4" - 2 Holes	86841450 / K-18-4D
NILFISK - ADVANCE /AMERICAN LINCOLN / CLARKE / KENT	56046980	GASKET	86842190 / K-G-5
NILFISK - ADVANCE /AMERICAN LINCOLN / CLARKE / KENT	56047599	BLADE, TAN GUM 2"x1/4"x10-1/2" - 5 Holes	86841520 / K-20-4C
NILFISK - ADVANCE /AMERICAN LINCOLN / CLARKE / KENT	56047601	BLADE, TAN GUM 2"x1/4"x3-1/2" - 2 Holes	86841530 / K-20-4D
NILFISK - ADVANCE /AMERICAN LINCOLN / CLARKE / KENT	56047602	BLADE, TAN GUM 2-1/8"x1/4"x25-1/2" - 13	86841510 / K-20-4A
NILFISK - ADVANCE /AMERICAN LINCOLN / CLARKE / KENT	56048140	WASHER	86657290 / K-G-6
NILFISK - ADVANCE /AMERICAN LINCOLN / CLARKE / KENT	56048165	SQUEEGEE BLADE (GUM)	86841650 / K-26-5D
NILFISK - ADVANCE /AMERICAN LINCOLN / CLARKE / KENT	56048168	SQUEEGEE BLADE (GUM)	86841800 / K-320-5A
NILFISK - ADVANCE /AMERICAN LINCOLN / CLARKE / KENT	56048247	#35 LINK CONN.895101	86633930 / BLC-35
NILFISK - ADVANCE /AMERICAN LINCOLN / CLARKE / KENT	56048257	INLET ELBOW GASKET	86842140 / K-G-1
NILFISK - ADVANCE /AMERICAN LINCOLN / CLARKE / KENT	56048525	BLADE, TAN GUM 2-1/8"x3/16"x32-3/4" - 16	86841570 / K-260-5A
NILFISK - ADVANCE /AMERICAN LINCOLN / CLARKE / KENT	56048525	BLADE, TAN GUM 2-1/8"x3/16"x32-3/4" - 16	86841630 / K-26-5A
NILFISK - ADVANCE /AMERICAN LINCOLN / CLARKE / KENT	56048527	BLADE, TAN GUM 2"x1/4"x-11" - 6 Holes	86841590 / K-260-5C
NILFISK - ADVANCE /AMERICAN LINCOLN / CLARKE / KENT	56048563	VAC POT GASKET	86842160 / K-G-2
NILFISK - ADVANCE /AMERICAN LINCOLN / CLARKE / KENT	56048652	SQUEEGEE GASKET	86842170 / K-G-3
NILFISK - ADVANCE /AMERICAN LINCOLN / CLARKE / KENT	56048697	Plug 1-3/4 DRAIN HOSE	86006340 / VAL-4
NILFISK - ADVANCE /AMERICAN LINCOLN / CLARKE / KENT	56048777	PIPE UNION GASKET	86842210 / K-G-7
NILFISK - ADVANCE /AMERICAN LINCOLN / CLARKE / KENT	56049261	BUMPER WHEEL	86618540 / WA-10
NILFISK - ADVANCE /AMERICAN LINCOLN / CLARKE / KENT	56049355	VACUUM MOTOR GASKET	86842220 / K-G-8
NILFISK - ADVANCE /AMERICAN LINCOLN / CLARKE / KENT	56049376	CASTER WHEEL *	86855920 / WK-6
NILFISK - ADVANCE /AMERICAN LINCOLN / CLARKE / KENT	56049909	BLADE, NEO 1-1/2"x1/4"x32-3/4" -16 Holes	86841580 / K-260-5B
NILFISK - ADVANCE /AMERICAN LINCOLN / CLARKE / KENT	56050504	VALVE	86709130 / VK-4
NILFISK - ADVANCE /AMERICAN LINCOLN / CLARKE / KENT	56051421	(k) CHAIN	98480220 / BLK-8
NILFISK - ADVANCE /AMERICAN LINCOLN / CLARKE / KENT	56052218	(k) WHEEL - 6" X 1"WIDTH 1/2"CH	98481310 / WK-4
NILFISK - ADVANCE /AMERICAN LINCOLN / CLARKE / KENT	56053777	BLADE, TAN GUM 2-1/8"x3/16"x41-1/2" - 10	86841910 / K-326-2B
NILFISK - ADVANCE /AMERICAN LINCOLN / CLARKE / KENT	56053778	BLADE, TAN GUM 2-1/8"x3/16"x43" - 22 Hol	86841900 / K-326-2A
NILFISK - ADVANCE /AMERICAN LINCOLN / CLARKE / KENT	56053807	BLADE, TAN GUM 1-3/4"x1/8"x32-3/4" -13 N	86841680 / K-266-2B
NILFISK - ADVANCE /AMERICAN LINCOLN / CLARKE / KENT	56053808	BLADE, TAN GUM 2-1/8"x3/16"x35-3/8" -18	86841670 / K-266-2A
NILFISK - ADVANCE /AMERICAN LINCOLN / CLARKE / KENT	56054085	RUBBER VIBRATION DAMPENING MOUNT (054085	86842150 / K-G-10
NILFISK - ADVANCE /AMERICAN LINCOLN / CLARKE / KENT	56054557	BLADE, TAN GUM 1-3/4"x1/8"x32-3/4" -13 Nt	86841740 / K-266N-3C
NILFISK - ADVANCE /AMERICAN LINCOLN / CLARKE / KENT	56054558	RUBBER SQUEEGEE	86656500 / K-266N-3A
NILFISK - ADVANCE /AMERICAN LINCOLN / CLARKE / KENT	56054559	BLADE, NEO BACKUP 1-3/4"x1/8"x34-5/15" -	86841730 / K-266N-3B
NILFISK - ADVANCE /AMERICAN LINCOLN / CLARKE / KENT	56054562	BLADE, TAN GUM BACKUP 1-3/4"x1/8"x40-3/8	86841940 / K-326N-3B

Visit our website for the most current and complete OEM interchange



OEM	OEM Part #	Material Description	Graco Part # / Old Graco#
NILFISK - ADVANCE /AMERICAN LINCOLN / CLARKE / KENT	56054563	BLADE, TAN GUM 2-3/4"x3/16"x40-3/8" - 8	86841930 / K-326N-3A
NILFISK - ADVANCE /AMERICAN LINCOLN / CLARKE / KENT	56054564	BLADE, NEO 1-3/4"x1"x41-3/4" - 8 Holes (86841950 / K-326N-3C
NILFISK - ADVANCE /AMERICAN LINCOLN / CLARKE / KENT	56054686	BLADE, NEO 1-3/4"x1/8"x49-1/2"-10 HOLES	86842050 / K-381-3B
NILFISK - ADVANCE /AMERICAN LINCOLN / CLARKE / KENT	56054687	BLADE, TAN GUM 2-3/4"x3/16"x50-1/2" - 10	86842040 / K-381-3A
NILFISK - ADVANCE /AMERICAN LINCOLN / CLARKE / KENT	56054688	BLADE, TAN GUM 1-3/4"x1/8"x47" -17 Slots	86842060 / K-381-3C
NILFISK - ADVANCE /AMERICAN LINCOLN / CLARKE / KENT	56054793	BLADE, TAN GUM 1-3/4"x1/8"x27-3/4" -8 Slo	86841490 / K-201-3C
NILFISK - ADVANCE /AMERICAN LINCOLN / CLARKE / KENT	56054794	BLADE, TAN GUM 2-3/4"x3/16"x30-1/8" -8 H	86841470 / K-201-3A
NILFISK - ADVANCE /AMERICAN LINCOLN / CLARKE / KENT	56054795	BLADE, NEO 1-3/4"x1/8"x28-3/4" - 8 Holes	86841480 / K-201-3B
NILFISK - ADVANCE /AMERICAN LINCOLN / CLARKE / KENT	56054857	RUBBER PAD (054857)	86842230 / K-G-9
NILFISK - ADVANCE /AMERICAN LINCOLN / CLARKE / KENT	56055070	VALVE	86709130 / VK-4
NILFISK - ADVANCE /AMERICAN LINCOLN / CLARKE / KENT	56055657	5" POLY SWIVEL CASTER(F) (QBA)	86606110 / WC-3
NILFISK - ADVANCE /AMERICAN LINCOLN / CLARKE / KENT	56055657	5" POLY SWIVEL CASTER(F) (QBA)	86606110 / WC-3
NILFISK - ADVANCE /AMERICAN LINCOLN / CLARKE / KENT	56055658	5" POLY SWIVEL CASTER(F) (QBA)	86606110 / WC-3
NILFISK - ADVANCE /AMERICAN LINCOLN / CLARKE / KENT	56056425	BLADE, NEO 2-3/16"x1/8"x35-7/8" - 8 Hls,9	86841780 / K-27-3C
NILFISK - ADVANCE /AMERICAN LINCOLN / CLARKE / KENT	56056426	BLADE, NEO BACKUP 1-3/4"x1/8"x36-13/16"	86841770 / K-27-3B
NILFISK - ADVANCE /AMERICAN LINCOLN / CLARKE / KENT	56056427	BLADE, TAN GUM 2-1/4"x3/16"x36-3/4" -8 H	86841760 / K-27-3A
NILFISK - ADVANCE /AMERICAN LINCOLN / CLARKE / KENT	56056428	BLADE, NEO BACKUP 2-3/16"x1/8"x42-7/32"	86841990 / K-33-3C
NILFISK - ADVANCE /AMERICAN LINCOLN / CLARKE / KENT	56056429	BLADE, TAN GUM 2-1/4"x3/16"x43-3/16" - 8	86841970 / K-33-3A
NILFISK - ADVANCE /AMERICAN LINCOLN / CLARKE / KENT	56056430	BLADE, NEO BACKUP 1-3/4"x1/8"x36-13/16"	86841980 / K-33-3B
NILFISK - ADVANCE /AMERICAN LINCOLN / CLARKE / KENT	56056632	BLADE, NEO 2-1/8"x1/8"x48-3/4"-10 Hls,11	86842100 / K-39-2B
NILFISK - ADVANCE /AMERICAN LINCOLN / CLARKE / KENT	56056633	BLADE, TAN GUM 50" Long - 10 Holes (rear	86842080 / K-39-3A
NILFISK - ADVANCE /AMERICAN LINCOLN / CLARKE / KENT	56056635	BLADE, NEO 1-3/4"x1/8"x49-1/2" 10 HOLES	86842090 / K-39-3B
NILFISK - ADVANCE /AMERICAN LINCOLN / CLARKE / KENT	56096773	24V VAC MOTOR (QBA) (116155-00)	86601190 / VM-1
NILFISK - ADVANCE /AMERICAN LINCOLN / CLARKE / KENT	56100622	CHARGER PLUG HOUSING (QBA)	86609730 / CHP-9
NILFISK - ADVANCE /AMERICAN LINCOLN / CLARKE / KENT	56102513	CENTERLOCK-PAD HOLDER	86633860 / PH-7
NILFISK - ADVANCE /AMERICAN LINCOLN / CLARKE / KENT	56102517	FLANGE	86642180
NILFISK - ADVANCE /AMERICAN LINCOLN / CLARKE / KENT	56102519	IDLER, PULLEY 4"	86652140
NILFISK - ADVANCE /AMERICAN LINCOLN / CLARKE / KENT	56102524	LP TANK (STEEL)	86262920 / PB-9
NILFISK - ADVANCE /AMERICAN LINCOLN / CLARKE / KENT	56102553	ELECTRIC FUEL LOCKOFF - PB-81	86635630
NILFISK - ADVANCE /AMERICAN LINCOLN / CLARKE / KENT	56102562	BONNET FILTER, SHORT 3.25" X 9.5"	86636780 / PB-162
NILFISK - ADVANCE /AMERICAN LINCOLN / CLARKE / KENT	56102566	SOLENOID -STARTER 12V	86635790
NILFISK - ADVANCE /AMERICAN LINCOLN / CLARKE / KENT	56105529	THROTTLE CABLE (LEFT) UNIVERSAL	86847550 / PB-4L
NILFISK - ADVANCE /AMERICAN LINCOLN / CLARKE / KENT	56107029	CORD SET,14/3 SJTW-A X 50' YLW	86234110
NILFISK - ADVANCE /AMERICAN LINCOLN / CLARKE / KENT	56110013	BRUSH 48" 180 MIDLITE	88056900
NILFISK - ADVANCE /AMERICAN LINCOLN / CLARKE / KENT	56111650	BLADE KIT, RED	98486690
NILFISK - ADVANCE /AMERICAN LINCOLN / CLARKE / KENT	56111652	BLADE KIT, TAN GUM	98486700
NILFISK - ADVANCE /AMERICAN LINCOLN / CLARKE / KENT	56112247	BLADE KIT- GUM 26-28	98486830
NILFISK - ADVANCE /AMERICAN LINCOLN / CLARKE / KENT	56112248	BLADE KIT- RED 26-28	98486850
NILFISK - ADVANCE /AMERICAN LINCOLN / CLARKE / KENT	56112250	BLADE KIT- GUM 32-34	98486840
NILFISK - ADVANCE /AMERICAN LINCOLN / CLARKE / KENT	56112251	BLADE KIT- RED 32-34	98486860
NILFISK - ADVANCE /AMERICAN LINCOLN / CLARKE / KENT	56154091	BEARING, BALL (6205-2RS)	86626370 / MC-1-B
NILFISK - ADVANCE /AMERICAN LINCOLN / CLARKE / KENT	56157562	(k) EA-3 SWITCH WITH HOLE	98484310 / EA-3-H
NILFISK - ADVANCE /AMERICAN LINCOLN / CLARKE / KENT	56158364	BELT FLEX O GEAR	86717610 / BLA-2
NILFISK - ADVANCE /AMERICAN LINCOLN / CLARKE / KENT	56158399	BELT	86618350 / BLA-9
NILFISK - ADVANCE /AMERICAN LINCOLN / CLARKE / KENT	56158402	BELT	86828110 / BLA-3
NILFISK - ADVANCE /AMERICAN LINCOLN / CLARKE / KENT	56161691	WHEEL	86620300 / WA-91
NILFISK - ADVANCE /AMERICAN LINCOLN / CLARKE / KENT	56168768	RECTIFIER	86637340 / EA-62
NILFISK - ADVANCE /AMERICAN LINCOLN / CLARKE / KENT	56171160	CAPACITOR	86620220 / EA-61
NILFISK - ADVANCE /AMERICAN LINCOLN / CLARKE / KENT	56171183	SWITCH EA-14	86616090 / EA-14
NILFISK - ADVANCE /AMERICAN LINCOLN / CLARKE / KENT	56171200	DRIVE BELT	86634540 / BLA-4

Visit our website for the most current and complete OEM interchange



OEM	OEM Part #	Material Description	Graco Part # / Old Graco#
NILFISK - ADVANCE /AMERICAN LINCOLN / CLARKE / KENT	56171225	SWITCH EA-14	86616090 / EA-14
NILFISK - ADVANCE /AMERICAN LINCOLN / CLARKE / KENT	56171228	SWITCH	86619930 / EA-60
NILFISK - ADVANCE /AMERICAN LINCOLN / CLARKE / KENT	56171472	MOTOR BRUSH (SET 2)	86623330 / EA-76
NILFISK - ADVANCE /AMERICAN LINCOLN / CLARKE / KENT	56171535	CIRCUIT BREAKER (17 AMP)	86608510 / EA-24
NILFISK - ADVANCE /AMERICAN LINCOLN / CLARKE / KENT	56171552	CAPACITOR	86634670 / EA-64
NILFISK - ADVANCE /AMERICAN LINCOLN / CLARKE / KENT	56171554	CIRCUIT BREAKER (17 AMP)	86608510 / EA-24
NILFISK - ADVANCE /AMERICAN LINCOLN / CLARKE / KENT	56180032	FILTER	86619200 / FA-10
NILFISK - ADVANCE /AMERICAN LINCOLN / CLARKE / KENT	56180146	SPRING-CARBON BRUSH (F)	86833460 / EA-2001
NILFISK - ADVANCE /AMERICAN LINCOLN / CLARKE / KENT	56182058	PAD HOLDER-CLIP 56182058	86633840 / PH-3-P
NILFISK - ADVANCE /AMERICAN LINCOLN / CLARKE / KENT	56183575	MOTOR 115V, 1.5 HP 1500 RPM	86844070 / MTA-5
NILFISK - ADVANCE /AMERICAN LINCOLN / CLARKE / KENT	56183581	((k) CARBON BRUSH SET (4)	98480360 / EA-77
NILFISK - ADVANCE /AMERICAN LINCOLN / CLARKE / KENT	56185158	WHEEL	86620200 / WA-12
NILFISK - ADVANCE /AMERICAN LINCOLN / CLARKE / KENT	56200298	GASKET	86804560 / AD-G-15
NILFISK - ADVANCE /AMERICAN LINCOLN / CLARKE / KENT	56200336	SWITCH, TOGGLE	86606630 / EA-3
NILFISK - ADVANCE /AMERICAN LINCOLN / CLARKE / KENT	56200340	SWITCH, TOGGLE	86606630 / EA-3
NILFISK - ADVANCE /AMERICAN LINCOLN / CLARKE / KENT	56200379	GASKET (933) (QBA)	86831840 / C-G-33
NILFISK - ADVANCE /AMERICAN LINCOLN / CLARKE / KENT	56200395	GASKET	86804710 / AD-G-4
NILFISK - ADVANCE /AMERICAN LINCOLN / CLARKE / KENT	56200573	GASKET	86804790 / AD-G-6
NILFISK - ADVANCE /AMERICAN LINCOLN / CLARKE / KENT	56200915	GASKET 1/4 X 7/8 X 30"	86804800 / AD-G-60
NILFISK - ADVANCE /AMERICAN LINCOLN / CLARKE / KENT	56200921	GASKET (1/4X7/8X24 IN)	86804620 / AD-G-20
NILFISK - ADVANCE /AMERICAN LINCOLN / CLARKE / KENT	56201034	SWITCH - LIFT & LOWER MPW-40	86617090 / EA-21
NILFISK - ADVANCE /AMERICAN LINCOLN / CLARKE / KENT	56201511	MOTOR 115V, 1.5 HP 1500 RPM	86844070 / MTA-5
NILFISK - ADVANCE /AMERICAN LINCOLN / CLARKE / KENT	56202304	24V VAC MOTOR (QBA) (116155-00)	86601190 / VM-1
NILFISK - ADVANCE /AMERICAN LINCOLN / CLARKE / KENT	56202320	36V 2 STAGE VAC MTR (QBA) (116156-00)	86854510 / VM-2
NILFISK - ADVANCE /AMERICAN LINCOLN / CLARKE / KENT	56202321	36V 2 STAGE VAC MTR (QBA) (116156-00)	86854510 / VM-2
NILFISK - ADVANCE /AMERICAN LINCOLN / CLARKE / KENT	56202322	36V 2 STAGE VAC MTR (QBA) (116156-00)	86854510 / VM-2
NILFISK - ADVANCE /AMERICAN LINCOLN / CLARKE / KENT	56202324	36V 2 STAGE VAC MTR (QBA) (116156-00)	86854510 / VM-2
NILFISK - ADVANCE /AMERICAN LINCOLN / CLARKE / KENT	56203394	STATIONARY FAN	86801050
NILFISK - ADVANCE /AMERICAN LINCOLN / CLARKE / KENT	56204001	SQUEEGEE SET (QBA)	86802780 / AD-17-4
NILFISK - ADVANCE /AMERICAN LINCOLN / CLARKE / KENT	56204006	SQUEEGEE SET (QBA)	98485870 / AD-20-4N
NILFISK - ADVANCE /AMERICAN LINCOLN / CLARKE / KENT	56204007	SQUEEGEE SET (QBA)	98485320 / AD-24-4
NILFISK - ADVANCE /AMERICAN LINCOLN / CLARKE / KENT	56204010	SQUEEGEE SET (QBA)	86804330 / AD-45-8
NILFISK - ADVANCE /AMERICAN LINCOLN / CLARKE / KENT	56204027	SQUEEGEE SET (NEO) (QBA)	86803320 / AD-24-4N
NILFISK - ADVANCE /AMERICAN LINCOLN / CLARKE / KENT	56204029	SQUEEGEE SET (NEO) (QBA)	86803090 / AD-20-4NN
NILFISK - ADVANCE /AMERICAN LINCOLN / CLARKE / KENT	56204031	SQUEEGEE SET (NEO) (QBA)	86803320 / AD-24-4N
NILFISK - ADVANCE /AMERICAN LINCOLN / CLARKE / KENT	56204033	SQUEEGEE SET (NEO) (QBA)	86803950 / AD-32-8N
NILFISK - ADVANCE /AMERICAN LINCOLN / CLARKE / KENT	56204153	GASKET	86804610 / AD-G-2
NILFISK - ADVANCE /AMERICAN LINCOLN / CLARKE / KENT	56204161	GASKET	86804700 / AD-G-3
NILFISK - ADVANCE /AMERICAN LINCOLN / CLARKE / KENT	56204295	SQUEEGEE SET (QBA)	86802770 / AD-14T-5
NILFISK - ADVANCE /AMERICAN LINCOLN / CLARKE / KENT	56205097	SQUEEGEE SET (QBA)	86803150 / AD-20T-5
NILFISK - ADVANCE /AMERICAN LINCOLN / CLARKE / KENT	56205983	CHARGER 24V 12A AUTO (50A RED)	86600920 / CH-10
NILFISK - ADVANCE /AMERICAN LINCOLN / CLARKE / KENT	56206107	SQUEEGEE BLADE (QBA)	86803350 / AD-24T-5
NILFISK - ADVANCE /AMERICAN LINCOLN / CLARKE / KENT	56206423	GASKET 1/4 X 1/2 X 93"	86804990 / AD-G-92
NILFISK - ADVANCE /AMERICAN LINCOLN / CLARKE / KENT	56206571	GASKET(1/16X1/2X37)	86804740 / AD-G-52
NILFISK - ADVANCE /AMERICAN LINCOLN / CLARKE / KENT	56206725	WHEEL CASTER 56206725	86608720 / WA-3
NILFISK - ADVANCE /AMERICAN LINCOLN / CLARKE / KENT	56206970	36V 20 AMPS. CHARGER W/50AMP GRAY	86719680 / CH-3650G
NILFISK - ADVANCE /AMERICAN LINCOLN / CLARKE / KENT	56206975	24V CHARGER	86719690 / CH-3650G
NILFISK - ADVANCE /AMERICAN LINCOLN / CLARKE / KENT	56206980	CHARGER 24V 12A AUTO (50A RED)	86600920 / CH-10
NILFISK - ADVANCE /AMERICAN LINCOLN / CLARKE / KENT	56206981	CHARGER 24V 12A AUTO (50A RED)	86600920 / CH-10
NILFISK - ADVANCE /AMERICAN LINCOLN / CLARKE / KENT	56207071	SWITCH, TOGGLE	86620060 / EC-39

Visit our website for the most current and complete OEM interchange



OEM	OEM Part #	Material Description	Graco Part # / Old Graco#
NILFISK - ADVANCE /AMERICAN LINCOLN / CLARKE / KENT	56207195	120 VOLT VAC MOTOR	86855020 / VM-7
NILFISK - ADVANCE /AMERICAN LINCOLN / CLARKE / KENT	56207802	120 VOLT VAC MOTOR	86855020 / VM-7
NILFISK - ADVANCE /AMERICAN LINCOLN / CLARKE / KENT	56208191	ROTATING FAN	86800990
NILFISK - ADVANCE /AMERICAN LINCOLN / CLARKE / KENT	56209095	120 VOLT 3 STAGE VAC MOTOR	86854760 / VM-33
NILFISK - ADVANCE /AMERICAN LINCOLN / CLARKE / KENT	56209307	120 VOLT VAC MOTOR	86855020 / VM-7
NILFISK - ADVANCE /AMERICAN LINCOLN / CLARKE / KENT	56209325	GASKET-VAC TOP 56209325	86619250 / AD-G-9
NILFISK - ADVANCE /AMERICAN LINCOLN / CLARKE / KENT	56209435	GASKET 1/8X1/2X95"	86804750 / AD-G-53
NILFISK - ADVANCE /AMERICAN LINCOLN / CLARKE / KENT	56209461	FILTER	86839200 / FA-61
NILFISK - ADVANCE /AMERICAN LINCOLN / CLARKE / KENT	56209509	GASKET 1/4 X 7/8 X 48"	86804820 / AD-G-63
NILFISK - ADVANCE /AMERICAN LINCOLN / CLARKE / KENT	56209617	GASKET 1/4 X 7/8 X 70"	86804830 / AD-G-64
NILFISK - ADVANCE /AMERICAN LINCOLN / CLARKE / KENT	56209619	GASKET 1/4 X 7/8 X 72"	86804840 / AD-G-27
NILFISK - ADVANCE /AMERICAN LINCOLN / CLARKE / KENT	56209763	GASKET	86619280 / AD-G-51
NILFISK - ADVANCE /AMERICAN LINCOLN / CLARKE / KENT	56209804	GASKET 3/16 X 1/2 X 72"	86804850 / AD-G-66
NILFISK - ADVANCE /AMERICAN LINCOLN / CLARKE / KENT	56209957	WIRE HOSE CUFF1-1/2,1-1/2W (QBA)	86609780 / HC-7
NILFISK - ADVANCE /AMERICAN LINCOLN / CLARKE / KENT	56209977	120 VOLT VAC MOTOR	86855020 / VM-7
NILFISK - ADVANCE /AMERICAN LINCOLN / CLARKE / KENT	56212081	36V 3-STAGE VAC MOTOR (QBA) (119431-13)	86601200 / VM-24
NILFISK - ADVANCE /AMERICAN LINCOLN / CLARKE / KENT	56212175	MOTOR 36V 320RPM MTC-1 W/PLUG	98486100
NILFISK - ADVANCE /AMERICAN LINCOLN / CLARKE / KENT	56212205	GASKET, MOLDED 55"	98484520
NILFISK - ADVANCE /AMERICAN LINCOLN / CLARKE / KENT	56217859	SWITCH	86634630 / EA-30
NILFISK - ADVANCE /AMERICAN LINCOLN / CLARKE / KENT	56220045	VAC MOTOR ASM, 115V 4.8 2ST PD	86026750 / VM-46
NILFISK - ADVANCE /AMERICAN LINCOLN / CLARKE / KENT	56228051	BEARING/BALL	86608810 / AD-B-1
NILFISK - ADVANCE /AMERICAN LINCOLN / CLARKE / KENT	56228102	WHEEL///graco wa-11	86717660 / WA-11
NILFISK - ADVANCE /AMERICAN LINCOLN / CLARKE / KENT	56228414	BREAKER, 3 AMP 1681-090-300	86002000 / EA-22
NILFISK - ADVANCE /AMERICAN LINCOLN / CLARKE / KENT	56244901	GASKET 1/8 X 3/8 X 13"	86804880 / AD-G-71
NILFISK - ADVANCE /AMERICAN LINCOLN / CLARKE / KENT	56245608	BELT	86828020 / BLA-17
NILFISK - ADVANCE /AMERICAN LINCOLN / CLARKE / KENT	56249525	120V VAC MTR	86724030 / VM-17
NILFISK - ADVANCE /AMERICAN LINCOLN / CLARKE / KENT	56249684	GASKET(1/2X7/8X42 IN.)	86804530 / AD-G-12
NILFISK - ADVANCE /AMERICAN LINCOLN / CLARKE / KENT	56249930	FLOJET PUMP(QBA)(2100-032A)115VOLT,60PSI	86842580 / M-40
NILFISK - ADVANCE /AMERICAN LINCOLN / CLARKE / KENT	56249943	CHECK VALVE	86842590 / M-40-CK
NILFISK - ADVANCE /AMERICAN LINCOLN / CLARKE / KENT	56260098	DRAIN PLUG 1" - VTN-3	86621230 / VTN-3
NILFISK - ADVANCE /AMERICAN LINCOLN / CLARKE / KENT	56261237	(k)CONNECTOR ASSY.-BATTERY	98484450 / CHP-19
NILFISK - ADVANCE /AMERICAN LINCOLN / CLARKE / KENT	56262195	FLOJET PUMP(QBA)(2100-032A)115VOLT,60PSI	86842580 / M-40
NILFISK - ADVANCE /AMERICAN LINCOLN / CLARKE / KENT	56262536	120 VOLT 3 STAGE VAC MOTOR	86854740 / VM-31
NILFISK - ADVANCE /AMERICAN LINCOLN / CLARKE / KENT	56262576	GASKET	86717860 / AD-G-82
NILFISK - ADVANCE /AMERICAN LINCOLN / CLARKE / KENT	56262584	120 VOLT 3 STAGE VAC MOTOR	86854740 / VM-31
NILFISK - ADVANCE /AMERICAN LINCOLN / CLARKE / KENT	56262626	BEARING	86726540 / CB-14
NILFISK - ADVANCE /AMERICAN LINCOLN / CLARKE / KENT	56263254	24 VOLT 3 STAGE VAC MOTOR	86854780 / VM-34
NILFISK - ADVANCE /AMERICAN LINCOLN / CLARKE / KENT	56264305	PUMP	86694440 / M-42
NILFISK - ADVANCE /AMERICAN LINCOLN / CLARKE / KENT	56265096	VAC MOTOR	86854580 / VM-25
NILFISK - ADVANCE /AMERICAN LINCOLN / CLARKE / KENT	56300096	GASKET 3/16 X 1/2 X 45"	86804890 / AD-G-74
NILFISK - ADVANCE /AMERICAN LINCOLN / CLARKE / KENT	56300381	120 VOLT 2 STAGE VAC MOTOR	86854820 / VM-4
NILFISK - ADVANCE /AMERICAN LINCOLN / CLARKE / KENT	56300853	(k) 1.5"X4' VAC HOSE W/CUFFS	98483940 / VHA-15
NILFISK - ADVANCE /AMERICAN LINCOLN / CLARKE / KENT	56301313	(k) 1.5"X4' VAC HOSE W/CUFFS	98483940 / VHA-15
NILFISK - ADVANCE /AMERICAN LINCOLN / CLARKE / KENT	56301636	SWITCH, TOGGLE	86620060 / EC-39
NILFISK - ADVANCE /AMERICAN LINCOLN / CLARKE / KENT	56303471	SQUEEGEE SET, RED	98486470
NILFISK - ADVANCE /AMERICAN LINCOLN / CLARKE / KENT	56303472	SQUEEGEE SET, RED	98486480
NILFISK - ADVANCE /AMERICAN LINCOLN / CLARKE / KENT	56305686	SQUEEGEE SET, RED 48	98486490
NILFISK - ADVANCE /AMERICAN LINCOLN / CLARKE / KENT	56305695	SQUEEGEE SET, RED 43	98486500
NILFISK - ADVANCE /AMERICAN LINCOLN / CLARKE / KENT	56305696	SQUEEGEE SET, RED 54	98486520
NILFISK - ADVANCE /AMERICAN LINCOLN / CLARKE / KENT	56305697	SIDE BLADE KIT-RED (CONTAINS 4 BLADES)	98486320

Visit our website for the most current and complete OEM interchange



OEM	OEM Part #	Material Description	Graco Part # / Old Graco#
NILFISK - ADVANCE /AMERICAN LINCOLN / CLARKE / KENT	56305697	SIDE BLADE KIT-RED (CONTAINS 4 BLADES)	98486320
NILFISK - ADVANCE /AMERICAN LINCOLN / CLARKE / KENT	56314029	FRONT BLADE	86697610 / AD-26V-2B
NILFISK - ADVANCE /AMERICAN LINCOLN / CLARKE / KENT	56314050	BLADE REAR (QBA) 26 & 28 ADVENGER	86803550 / AD-26V-2A
NILFISK - ADVANCE /AMERICAN LINCOLN / CLARKE / KENT	56314054	BLADE KIT 24 ADVENGER (QBA)	98485750 / AD-24V-2
NILFISK - ADVANCE /AMERICAN LINCOLN / CLARKE / KENT	56314060	BLADE KIT ADVENGER 32 (QBA)	98485900 / AD-32V-2
NILFISK - ADVANCE /AMERICAN LINCOLN / CLARKE / KENT	56314126	BLADE KIT, GUM, 28" DECK	98486370
NILFISK - ADVANCE /AMERICAN LINCOLN / CLARKE / KENT	56314126	BLADE KIT, GUM, 28" DECK	98486370
NILFISK - ADVANCE /AMERICAN LINCOLN / CLARKE / KENT	56314137	BLADE, REAR 3/16 GUM (28")	86859490
NILFISK - ADVANCE /AMERICAN LINCOLN / CLARKE / KENT	56314146	BLADE, FRONT 3/16 GUM (28")	86859540
NILFISK - ADVANCE /AMERICAN LINCOLN / CLARKE / KENT	56314303	Blade Kit (QBA) 26 & 28 Advenger, Warrior St 1red inside	98485730 / AD-26V-2
NILFISK - ADVANCE /AMERICAN LINCOLN / CLARKE / KENT	56314304	BLADE KIT 26,28 (QBA) LINATEX	98485880
NILFISK - ADVANCE /AMERICAN LINCOLN / CLARKE / KENT	56314314	BLADE REAR 24 ADVENGER (QBA)	86803380 / AD-24V-2B
NILFISK - ADVANCE /AMERICAN LINCOLN / CLARKE / KENT	56314315	BLADE REAR 24 ADVENGER (QBA)	86803370 / AD-24V-2A
NILFISK - ADVANCE /AMERICAN LINCOLN / CLARKE / KENT	56314340	BLADE, OUTER 1/4 GUM (EA)	86859480
NILFISK - ADVANCE /AMERICAN LINCOLN / CLARKE / KENT	56314343	BLADE, FRONT 3/16 GUM (32")	86859530
NILFISK - ADVANCE /AMERICAN LINCOLN / CLARKE / KENT	56314397	(k) SKIRTKIT, ADVENGER 28" GUM	98481960
NILFISK - ADVANCE /AMERICAN LINCOLN / CLARKE / KENT	56314530	SKIRT, CYLINDRICAL SCRUB HEAD, 1/4" LINA	86804490 / AD-CYLR-S
NILFISK - ADVANCE /AMERICAN LINCOLN / CLARKE / KENT	56314533	VAC HOSE ASSY. 1.5"	98484500
NILFISK - ADVANCE /AMERICAN LINCOLN / CLARKE / KENT	56314547	BLADE, OUTER 1/4 RED GUM (EA)	86859470
NILFISK - ADVANCE /AMERICAN LINCOLN / CLARKE / KENT	56314846	BLADE KIT, RED 35" DISK	98486530
NILFISK - ADVANCE /AMERICAN LINCOLN / CLARKE / KENT	56314848	BLADE KIT, RED 38" DISK	98486540
NILFISK - ADVANCE /AMERICAN LINCOLN / CLARKE / KENT	56314860	BLADE KIT, RED, CLY DECK	98486550
NILFISK - ADVANCE /AMERICAN LINCOLN / CLARKE / KENT	56314865	BLADE SET, RED AD-W2832-2R	98486160
NILFISK - ADVANCE /AMERICAN LINCOLN / CLARKE / KENT	56314883	BLADE, INNER 1/4 GUM (EA)	86859510
NILFISK - ADVANCE /AMERICAN LINCOLN / CLARKE / KENT	56314895	BLADE, INNER 1/4 RED GUM (EA)	86859500
NILFISK - ADVANCE /AMERICAN LINCOLN / CLARKE / KENT	56314913	(k) SKIRTKIT, ADVENGER 28" GUM	98481960
NILFISK - ADVANCE /AMERICAN LINCOLN / CLARKE / KENT	56314913	SKIRTKIT, ADVENGER 28"	98481960
NILFISK - ADVANCE /AMERICAN LINCOLN / CLARKE / KENT	56314914	BLADE KIT, TAN GUM 32" DISK	98486560
NILFISK - ADVANCE /AMERICAN LINCOLN / CLARKE / KENT	56314914	(k) SKIRT KIT, ADVENGER 32" GUM	98481950
NILFISK - ADVANCE /AMERICAN LINCOLN / CLARKE / KENT	56314917	(k) SKIRTKIT, ADVENGER 8" RED	98481970
NILFISK - ADVANCE /AMERICAN LINCOLN / CLARKE / KENT	56314917	Kit, Red Gum Rubber 28 Disk (Standard)	98481970
NILFISK - ADVANCE /AMERICAN LINCOLN / CLARKE / KENT	56314918	SKIRT KIT, ADVENGER 32" RED	98481940
NILFISK - ADVANCE /AMERICAN LINCOLN / CLARKE / KENT	56315051	TIRE ASSY,GRAY HD FOAM,410/3.5-6 3.5BC	98486050 / WTN-7
NILFISK - ADVANCE /AMERICAN LINCOLN / CLARKE / KENT	56315098	GASKET, 20/24 VAC MOTOR	86003870 / TN-G-6
NILFISK - ADVANCE /AMERICAN LINCOLN / CLARKE / KENT	56315220	GASKET COVER	86618920
NILFISK - ADVANCE /AMERICAN LINCOLN / CLARKE / KENT	56315220	GASKET, 3/8" X 46-1/2"	86857070
NILFISK - ADVANCE /AMERICAN LINCOLN / CLARKE / KENT	56315268	VAC HOSE - VHA-19	98482080
NILFISK - ADVANCE /AMERICAN LINCOLN / CLARKE / KENT	56315275	SKIRT RUBBER, CONVERTAMATIC 26D	86899060 / AD-26D-2
NILFISK - ADVANCE /AMERICAN LINCOLN / CLARKE / KENT	56315290	Squeegee Set, Red	98486220
NILFISK - ADVANCE /AMERICAN LINCOLN / CLARKE / KENT	56315347	BLADE SET GUM 24"	98486880
NILFISK - ADVANCE /AMERICAN LINCOLN / CLARKE / KENT	56315348	SQUEEGEE SET, (QBA) CONVERTAMATIC 26C-D,28C-D	98485850
NILFISK - ADVANCE /AMERICAN LINCOLN / CLARKE / KENT	56315352	Squeegee Set, Red	98486220
NILFISK - ADVANCE /AMERICAN LINCOLN / CLARKE / KENT	56315631	SQUEEGEE FRONT FOR WARRIOR 28/32, GUM	86805180 / AD-W2832-2B
NILFISK - ADVANCE /AMERICAN LINCOLN / CLARKE / KENT	56315673	SQUEEGEE REAR FOR WARRIOR 28/32, GUM	86805170 / AD-W2832-2A
NILFISK - ADVANCE /AMERICAN LINCOLN / CLARKE / KENT	56315674	SQUEEGEE SET FOR WARRIOR 28/32, GUM	98485250 / AD-W2832-2
NILFISK - ADVANCE /AMERICAN LINCOLN / CLARKE / KENT	56315720	BLADE KIT, RED	98486570
NILFISK - ADVANCE /AMERICAN LINCOLN / CLARKE / KENT	56315722	BLADE KIT, TAN GUM	98486580
NILFISK - ADVANCE /AMERICAN LINCOLN / CLARKE / KENT	56315742	CLAMP, SKIRT	86858720
NILFISK - ADVANCE /AMERICAN LINCOLN / CLARKE / KENT	56320986	GASKET 3/16 X1/2X18-1/2"	86804900 / AD-G-77
NILFISK - ADVANCE /AMERICAN LINCOLN / CLARKE / KENT	56321125	RING	86703640 / SPA-2

Visit our website for the most current and complete OEM interchange



OEM	OEM Part #	Material Description	Graco Part # / Old Graco#
NILFISK - ADVANCE /AMERICAN LINCOLN / CLARKE / KENT	56321281	SWITCH - LIFT & LOWER MPW-40	86617090 / EA-21
NILFISK - ADVANCE /AMERICAN LINCOLN / CLARKE / KENT	56323153	BAGS, FILTER (10 PACK) - CARPETWIN 16XP/	86848240
NILFISK - ADVANCE /AMERICAN LINCOLN / CLARKE / KENT	56323177	MOTOR 116311-01	86634780 / VM-51
NILFISK - ADVANCE /AMERICAN LINCOLN / CLARKE / KENT	56324022	BELT	86828180 / BLA-71
NILFISK - ADVANCE /AMERICAN LINCOLN / CLARKE / KENT	56324025	BLADE, TAN GUM (QBA) 3"x1/4"x26-15/16" -	86802980
NILFISK - ADVANCE /AMERICAN LINCOLN / CLARKE / KENT	56324026	BLADE, NEO (QBA) 3"x1/8"x25-7/16" -50 SI	86802970
NILFISK - ADVANCE /AMERICAN LINCOLN / CLARKE / KENT	56324028	BLUE LIGHT	86618450 / EA-91
NILFISK - ADVANCE /AMERICAN LINCOLN / CLARKE / KENT	56324036	(k) WIRE ROPE-SQUEEGEE-UPPER	98481430 / SA-3
NILFISK - ADVANCE /AMERICAN LINCOLN / CLARKE / KENT	56324189	24 VOLT 2 STAGE VAC MOTOR	86854670 / VM-29
NILFISK - ADVANCE /AMERICAN LINCOLN / CLARKE / KENT	56324247	VALVE ASSY,SOLENOID	86620160 / EA-82
NILFISK - ADVANCE /AMERICAN LINCOLN / CLARKE / KENT	56324254	SQUEEGEE SET (QBA)	98485030 / AD-200-2
NILFISK - ADVANCE /AMERICAN LINCOLN / CLARKE / KENT	56324272	SWITCH, ROCKER 56324272 ***SEE NOTE***	86620040 / EA-84
NILFISK - ADVANCE /AMERICAN LINCOLN / CLARKE / KENT	56324284	BATTERY CABLE	86827720 / BC425R
NILFISK - ADVANCE /AMERICAN LINCOLN / CLARKE / KENT	56324305	50A.PLUG (RED)911185	86634110 / CHP-2-R
NILFISK - ADVANCE /AMERICAN LINCOLN / CLARKE / KENT	56324322	BLADE	86646130 / AD-200N-2A
NILFISK - ADVANCE /AMERICAN LINCOLN / CLARKE / KENT	56324325	BLADE, NEO (QBA) 2-1/4"x1/8"x25-3/4" -6	86803020
NILFISK - ADVANCE /AMERICAN LINCOLN / CLARKE / KENT	56324350	BUMPER WHEEL (F) 2 1/2 x 3/4	86603320 / WA-7
NILFISK - ADVANCE /AMERICAN LINCOLN / CLARKE / KENT	56324362	SWITCH 56324362	86620020 / EA-89
NILFISK - ADVANCE /AMERICAN LINCOLN / CLARKE / KENT	56324385	SQUEEGEE SET (QBA) (after sn# 511035)	98485050 / AD-200N-2
NILFISK - ADVANCE /AMERICAN LINCOLN / CLARKE / KENT	56324489	24 VOLT 3 STAGE VAC MOTOR	86854780 / VM-34
NILFISK - ADVANCE /AMERICAN LINCOLN / CLARKE / KENT	56324499	BUMPER WHEEL	86618540 / WA-10
NILFISK - ADVANCE /AMERICAN LINCOLN / CLARKE / KENT	56325096	120 VOLT VAC MOTOR	86854990 / VM-6
NILFISK - ADVANCE /AMERICAN LINCOLN / CLARKE / KENT	56325140	SWITCH	86619950 / EA-15
NILFISK - ADVANCE /AMERICAN LINCOLN / CLARKE / KENT	56325324	GASKET (1/4X1/4X65 1/2)	86804630 / AD-G-21
NILFISK - ADVANCE /AMERICAN LINCOLN / CLARKE / KENT	56325324	GASKET (1/4X1/4X65.5)	86804780 / AD-G-57
NILFISK - ADVANCE /AMERICAN LINCOLN / CLARKE / KENT	56325328	GASKET (1/4X1/4X65.5)	86804780 / AD-G-57
NILFISK - ADVANCE /AMERICAN LINCOLN / CLARKE / KENT	56327450	SWITCH N.C./N.O.(PRES.)	86652610 / EA-31
NILFISK - ADVANCE /AMERICAN LINCOLN / CLARKE / KENT	56327476	BELT	86672600 / BLA-14
NILFISK - ADVANCE /AMERICAN LINCOLN / CLARKE / KENT	56327478	BELT	86672600 / BLA-14
NILFISK - ADVANCE /AMERICAN LINCOLN / CLARKE / KENT	56327530	WHEEL 4.00 X .968. bore=5/16	86609400 / WA-95
NILFISK - ADVANCE /AMERICAN LINCOLN / CLARKE / KENT	56328790	SPRING-HANDLE 56328790	86608680 / SPA-2000
NILFISK - ADVANCE /AMERICAN LINCOLN / CLARKE / KENT	56329177	BREAKER 6A.	86633680 / EA-23
NILFISK - ADVANCE /AMERICAN LINCOLN / CLARKE / KENT	56329193	BREAKER 6A.	86633680 / EA-23
NILFISK - ADVANCE /AMERICAN LINCOLN / CLARKE / KENT	56330690	3PK VAC BAG	86658580 / PBA-8
NILFISK - ADVANCE /AMERICAN LINCOLN / CLARKE / KENT	56330712	GASKET (280)	86804650 / AD-G-23
NILFISK - ADVANCE /AMERICAN LINCOLN / CLARKE / KENT	56331059	GASKET (3/16X3/8X50 IN)	86804660 / AD-G-24
NILFISK - ADVANCE /AMERICAN LINCOLN / CLARKE / KENT	56331098	WHEEL	86620300 / WA-91
NILFISK - ADVANCE /AMERICAN LINCOLN / CLARKE / KENT	56331100	BELT	86617860 / BLA-26
NILFISK - ADVANCE /AMERICAN LINCOLN / CLARKE / KENT	56331334	VACUUM MOTOR	86686220 / VM-10
NILFISK - ADVANCE /AMERICAN LINCOLN / CLARKE / KENT	56355933	GASKET 3/16 X 1/2 X 59"	86804910 / AD-G-78
NILFISK - ADVANCE /AMERICAN LINCOLN / CLARKE / KENT	56357355	GASKET	86619240 / AD-G-98
NILFISK - ADVANCE /AMERICAN LINCOLN / CLARKE / KENT	56361178	BLADE, NEO (QBA) 1-1/4"x1/16"x22" - 7 Ho	86802900 / AD-18-4B
NILFISK - ADVANCE /AMERICAN LINCOLN / CLARKE / KENT	56361186	BLADE, NEO (QBA) 1-18"x1/16"x22" - 7 Hole	86802910 / AD-18-4C
NILFISK - ADVANCE /AMERICAN LINCOLN / CLARKE / KENT	56361216	BLADE, TAN GUM (QBA) 1-3/8"x1/8"x22" - 7	86802890 / AD-18-4A
NILFISK - ADVANCE /AMERICAN LINCOLN / CLARKE / KENT	56361218	BLADE, NEO 1-1/4"x1/8"x24"-7 Holes	86803070
NILFISK - ADVANCE /AMERICAN LINCOLN / CLARKE / KENT	56361221	BLADE, NEO 1-1/8"x1/16"x24" -7 Holes	86803080
NILFISK - ADVANCE /AMERICAN LINCOLN / CLARKE / KENT	56361225	BLADE, NEO 1-3/8"x1/8"x24-1/4"-7 Holes	86803060
NILFISK - ADVANCE /AMERICAN LINCOLN / CLARKE / KENT	56361307	8"x1 5/8" RUBBER WHEEL (QBA) W/3/4 BRGS(86608740 / WA-5
NILFISK - ADVANCE /AMERICAN LINCOLN / CLARKE / KENT	56362336	8"x1 5/8" RUBBER WHEEL (QBA) W/3/4 BRGS	86608740 / WA-5
NILFISK - ADVANCE /AMERICAN LINCOLN / CLARKE / KENT	56362352	3/4 BEARING FOR WA-6	86618300 / WA-8

Visit our website for the most current and complete OEM interchange



OEM	OEM Part #	Material Description	Graco Part # / Old Graco#
NILFISK - ADVANCE /AMERICAN LINCOLN / CLARKE / KENT	56362892	SQUEEGEE CARTRIDGE-21	86618700 / AD-21-C
NILFISK - ADVANCE /AMERICAN LINCOLN / CLARKE / KENT	56363847	BLADE, NEO (QBA) 1-1/4"x1/8"x26" - 8 Hol	86803180 / AD-21-4B
NILFISK - ADVANCE /AMERICAN LINCOLN / CLARKE / KENT	56363855	BUMPER WHEEL (F) 2 1/2 x 3/4	86603320 / WA-7
NILFISK - ADVANCE /AMERICAN LINCOLN / CLARKE / KENT	56363882	SQUEEGEE CARTRIDGE (QBA) (24" CHANNEL, 2	86803220 / AD-21-C
NILFISK - ADVANCE /AMERICAN LINCOLN / CLARKE / KENT	56363892	SQUEEGEE CARTRIDGE (QBA) (24" CHANNEL, 2	86803220 / AD-21-C
NILFISK - ADVANCE /AMERICAN LINCOLN / CLARKE / KENT	56363928	BATTERY CABLE (QBA)	86827880 / BCSN412
NILFISK - ADVANCE /AMERICAN LINCOLN / CLARKE / KENT	56363936	BATTERY CABLE	86827890 / BCSN415
NILFISK - ADVANCE /AMERICAN LINCOLN / CLARKE / KENT	56363944	BATTERY CABLE	86827900 / BCSN420
NILFISK - ADVANCE /AMERICAN LINCOLN / CLARKE / KENT	56363979	BATTERY CABLE	86827700 / BC421R
NILFISK - ADVANCE /AMERICAN LINCOLN / CLARKE / KENT	56364186	(k) SQUEEGEE LIFT CABLE 28.2	98480920 / SA-6
NILFISK - ADVANCE /AMERICAN LINCOLN / CLARKE / KENT	56364187	(k) CABLE ASSY TO FIT 364187	98480880 / SA-11
NILFISK - ADVANCE /AMERICAN LINCOLN / CLARKE / KENT	56364194	(k) 175 AMP PLUG W/ CABLE	98483160 / CHP-3-A
NILFISK - ADVANCE /AMERICAN LINCOLN / CLARKE / KENT	56364210	METER, VOLT - DC (20-30) RECTANGULAR	86834000 / EAM-1
NILFISK - ADVANCE /AMERICAN LINCOLN / CLARKE / KENT	56364294	CIRCUIT BREAKER 45 AMP (QBA)	86609510 / EA-45
NILFISK - ADVANCE /AMERICAN LINCOLN / CLARKE / KENT	56365079	SWITCH	86619960 / EA-5
NILFISK - ADVANCE /AMERICAN LINCOLN / CLARKE / KENT	56365555	CASTER W/WHEEL (5-3/8) 56365555,630002	86618730 / WA-1
NILFISK - ADVANCE /AMERICAN LINCOLN / CLARKE / KENT	56365610	8"x1 5/8" RUBBER WHEEL (QBA) W/3/4 BRGS(86608740 / WA-5
NILFISK - ADVANCE /AMERICAN LINCOLN / CLARKE / KENT	56365645	AXLE FOR WA-1	86855330 / WA-1-A
NILFISK - ADVANCE /AMERICAN LINCOLN / CLARKE / KENT	56365661	SP CASTER RIG	86855350 / WA-1-F
NILFISK - ADVANCE /AMERICAN LINCOLN / CLARKE / KENT	56365718	BEARING FOR WA-1	86855340 / WA-1-B
NILFISK - ADVANCE /AMERICAN LINCOLN / CLARKE / KENT	56365742	4X2 POLY WHEEL W/BRG(F)	86616310 / WA-1-W
NILFISK - ADVANCE /AMERICAN LINCOLN / CLARKE / KENT	56368881	VALVE,3-WAY 56368881	86620150 / VA-3
NILFISK - ADVANCE /AMERICAN LINCOLN / CLARKE / KENT	56368903	VALVE 2 WAY	86620130 / VA-4
NILFISK - ADVANCE /AMERICAN LINCOLN / CLARKE / KENT	56370347	SWITCH BRUSH	86606590 / EA-8
NILFISK - ADVANCE /AMERICAN LINCOLN / CLARKE / KENT	56370711	KNOB, 5/16-18 4 PRONG	86004790 / SPA-3
NILFISK - ADVANCE /AMERICAN LINCOLN / CLARKE / KENT	56370932	BLADE, NEO (QBA) 1-1/8"x1/16"x26" - 8 Ho	86803190 / AD-21-4C
NILFISK - ADVANCE /AMERICAN LINCOLN / CLARKE / KENT	56370967	BLADE, TAN GUM (QBA) 1-3/8"x1/8"x26" - 8	86803170 / AD-21-4A
NILFISK - ADVANCE /AMERICAN LINCOLN / CLARKE / KENT	56371033	BLADE, NEO (QBA) 1-1/8"x1/16"x23" -10 Ho	86803310 / AD-24-4C
NILFISK - ADVANCE /AMERICAN LINCOLN / CLARKE / KENT	56371084	BLADE, TAN GUM (QBA) 1-3/8"x1/8"x28" - 1	86803280 / AD-24-4A
NILFISK - ADVANCE /AMERICAN LINCOLN / CLARKE / KENT	56371092	BLADE, NEO (QBA) 28-1/4" long - 10 Holes	86803290 / AD-24-4AN
NILFISK - ADVANCE /AMERICAN LINCOLN / CLARKE / KENT	56371106	BLADE, NEO (QBA) 1-1/4"x1/8" - 10 Holes	86803300 / AD-24-4B
NILFISK - ADVANCE /AMERICAN LINCOLN / CLARKE / KENT	56371408	Connector 175 DCA GRY W/O TERMS	88068250 / CHP-3
NILFISK - ADVANCE /AMERICAN LINCOLN / CLARKE / KENT	56371500	Connector 175 DCA RED W/O TERMS	88068240 / CHP-3-R
NILFISK - ADVANCE /AMERICAN LINCOLN / CLARKE / KENT	56372089	BATTERY FUEL GAUGE	86856840 / EAM-5
NILFISK - ADVANCE /AMERICAN LINCOLN / CLARKE / KENT	56372242	BELT	86617870 / BLA-1
NILFISK - ADVANCE /AMERICAN LINCOLN / CLARKE / KENT	56372505	24 VOLT 2 STAGE VAC MOTOR	86854670 / VM-29
NILFISK - ADVANCE /AMERICAN LINCOLN / CLARKE / KENT	56372524	BATTERY CABLE	86827700 / BC421R
NILFISK - ADVANCE /AMERICAN LINCOLN / CLARKE / KENT	56372588	ROTATING FAN	86800990
NILFISK - ADVANCE /AMERICAN LINCOLN / CLARKE / KENT	56372718	GASKET	86619220 / AD-G-11
NILFISK - ADVANCE /AMERICAN LINCOLN / CLARKE / KENT	56372764	BLADE, NEO (QBA) 1-3/8"x1/8"x31-3/4" -10	86803510 / AD-26HD-4B
NILFISK - ADVANCE /AMERICAN LINCOLN / CLARKE / KENT	56372766	BLADE, TAN GUM (QBA) 1-1/2"x1/8"x32-1/4"	86803500 / AD-26HD-4A
NILFISK - ADVANCE /AMERICAN LINCOLN / CLARKE / KENT	56372773	BEARING	86626340 / MC-23
NILFISK - ADVANCE /AMERICAN LINCOLN / CLARKE / KENT	56372786	SQUEEGEE SET-260BHD (QBA)	98485830 / AD-26HD-4
NILFISK - ADVANCE /AMERICAN LINCOLN / CLARKE / KENT	56372848	CHARGER 36V 20A AUTO.56395101	86738030 / CH-63
NILFISK - ADVANCE /AMERICAN LINCOLN / CLARKE / KENT	56372876	SKIRT,FRONT	86619670 / AD-260-FS
NILFISK - ADVANCE /AMERICAN LINCOLN / CLARKE / KENT	56372920	SKIRT,REAR	86619660 / AD-260-RS
NILFISK - ADVANCE /AMERICAN LINCOLN / CLARKE / KENT	56372946	CHARGER 36V 20A AUTO.56395101	86738030 / CH-63
NILFISK - ADVANCE /AMERICAN LINCOLN / CLARKE / KENT	56372947	CHARGER 24V. 20A.	86738010 / CH-31
NILFISK - ADVANCE /AMERICAN LINCOLN / CLARKE / KENT	56372955	CHARGER 36V 20A AUTO.56395101	86738030 / CH-63
NILFISK - ADVANCE /AMERICAN LINCOLN / CLARKE / KENT	56372966	CHARGER 36V 20A AUTO.56395101	86738030 / CH-63

Visit our website for the most current and complete OEM interchange



OEM	OEM Part #	Material Description	Graco Part # / Old Graco#
NILFISK - ADVANCE /AMERICAN LINCOLN / CLARKE / KENT	56372982	CARTRIDGE-SQ.26 56372982	86618660 / AD-26-C
NILFISK - ADVANCE /AMERICAN LINCOLN / CLARKE / KENT	56372992	CARTRIDGE-SQ.26 56372982	86618660 / AD-26-C
NILFISK - ADVANCE /AMERICAN LINCOLN / CLARKE / KENT	56373054	FUSE-LESTER,56373054	86637300 / CHP-8776
NILFISK - ADVANCE /AMERICAN LINCOLN / CLARKE / KENT	56373071	FUSE ASSY,40 AMP,DUAL LINK LESTER	86800120
NILFISK - ADVANCE /AMERICAN LINCOLN / CLARKE / KENT	56373454	(k) VA-3 WITH FITTINGS	98480720 / VA-3-A
NILFISK - ADVANCE /AMERICAN LINCOLN / CLARKE / KENT	56375358	GASKET	86804570 / AD-G-16
NILFISK - ADVANCE /AMERICAN LINCOLN / CLARKE / KENT	56376076	SKIRT 280(56376076)	86619630 / AD-280-S
NILFISK - ADVANCE /AMERICAN LINCOLN / CLARKE / KENT	56376288	SQUEEGEE CARTRIDGE (QBA)	86803650 / AD-280-C
NILFISK - ADVANCE /AMERICAN LINCOLN / CLARKE / KENT	56376348	SWITCH, ROCKER	86619990 / EA-37
NILFISK - ADVANCE /AMERICAN LINCOLN / CLARKE / KENT	56376365	24V VAC MOTOR (QBA) (116155-00)	86601190 / VM-1
NILFISK - ADVANCE /AMERICAN LINCOLN / CLARKE / KENT	56376435	SWITCH EA-14	86616090 / EA-14
NILFISK - ADVANCE /AMERICAN LINCOLN / CLARKE / KENT	56376485	(k) ROLLER ASSY (SQUEEGEE)	98480700 / SPA-5
NILFISK - ADVANCE /AMERICAN LINCOLN / CLARKE / KENT	56376548	SQUEEGEE SET 280-BHD (QBA)	98485890 / AD-280-3
NILFISK - ADVANCE /AMERICAN LINCOLN / CLARKE / KENT	56376566	SQUEEGEE-GUM (QBA)	86803620 / AD-280-3A
NILFISK - ADVANCE /AMERICAN LINCOLN / CLARKE / KENT	56376568	SQUEEGEE WEAR STRIP (QBA)	86803640 / AD-280-3C
NILFISK - ADVANCE /AMERICAN LINCOLN / CLARKE / KENT	56376948	DRAIN PLUG 1 1/2"621324	86601910 / VTN-1
NILFISK - ADVANCE /AMERICAN LINCOLN / CLARKE / KENT	56377003	SWITCH-BRUSH,47381A(1 1/2"L x 1"W)	86608080 / EA-36
NILFISK - ADVANCE /AMERICAN LINCOLN / CLARKE / KENT	56377313	(k)VAC HOSE ASSY, 27"	98481040
NILFISK - ADVANCE /AMERICAN LINCOLN / CLARKE / KENT	56377378	SQUEEGEE CART 40"	86658150 / AD-38-C
NILFISK - ADVANCE /AMERICAN LINCOLN / CLARKE / KENT	56377404	SQUEEGEE CARTRIDGE-380	86619760 / AD-380-C
NILFISK - ADVANCE /AMERICAN LINCOLN / CLARKE / KENT	56377470	36 VOLT 3 STAGE VAC MOTOR	86854650 / VM-280
NILFISK - ADVANCE /AMERICAN LINCOLN / CLARKE / KENT	56377477	36 VOLT 3 STAGE VAC MOTOR	86854650 / VM-280
NILFISK - ADVANCE /AMERICAN LINCOLN / CLARKE / KENT	56377718	SQUEEGEE SET 380BHD	86619870 / AD-380-4
NILFISK - ADVANCE /AMERICAN LINCOLN / CLARKE / KENT	56377872	SPLASHGUARD	86619800 / AD-24-S
NILFISK - ADVANCE /AMERICAN LINCOLN / CLARKE / KENT	56377945	(k)8X1-5/8 WHEEL W/GROOVES & 3/4 BEARING	98480900 / WA-6-C
NILFISK - ADVANCE /AMERICAN LINCOLN / CLARKE / KENT	56377961	(k)8X1-5/8 WHEEL W/GROOVES & 3/4 BEARING	98480900 / WA-6-C
NILFISK - ADVANCE /AMERICAN LINCOLN / CLARKE / KENT	56378259	BEARING RACES	86710160 / AD-B-4
NILFISK - ADVANCE /AMERICAN LINCOLN / CLARKE / KENT	56378267	BEARINGS	86710150 / AD-B-3
NILFISK - ADVANCE /AMERICAN LINCOLN / CLARKE / KENT	56378853	POLY BELT	86618900 / BLA-5
NILFISK - ADVANCE /AMERICAN LINCOLN / CLARKE / KENT	56379125	STRAINER, ROUND 1" OPENING	86619900 / FA-3
NILFISK - ADVANCE /AMERICAN LINCOLN / CLARKE / KENT	56379170	FLOAT SPRING	86850890 / SPA-1
NILFISK - ADVANCE /AMERICAN LINCOLN / CLARKE / KENT	56379196	(k) VACUUM HOSE ASSEMBLY	98481070 / VHA-5
NILFISK - ADVANCE /AMERICAN LINCOLN / CLARKE / KENT	56379208	(k) VACUUM HOSE ASSEMBLY	98480810 / VHA-7
NILFISK - ADVANCE /AMERICAN LINCOLN / CLARKE / KENT	56379584	SQ.CARTRIDGE 56377378	86609710 / AD-32-C
NILFISK - ADVANCE /AMERICAN LINCOLN / CLARKE / KENT	56379620	SQ.CARTRIDGE 56377378	86609710 / AD-32-C
NILFISK - ADVANCE /AMERICAN LINCOLN / CLARKE / KENT	56380235	ISOLATOR KIT 12 MOUNTS	98484350
NILFISK - ADVANCE /AMERICAN LINCOLN / CLARKE / KENT	56380236	ISOLATOR KIT 8 MOUNTS	98484360
NILFISK - ADVANCE /AMERICAN LINCOLN / CLARKE / KENT	56380364	GASKET(1/2X7/8X42 IN.)	86804530 / AD-G-12
NILFISK - ADVANCE /AMERICAN LINCOLN / CLARKE / KENT	56380763	GASKET	86804580 / AD-G-17
NILFISK - ADVANCE /AMERICAN LINCOLN / CLARKE / KENT	56380905	GASKET, VAC MTR	86003760 / AD-G-5
NILFISK - ADVANCE /AMERICAN LINCOLN / CLARKE / KENT	56380922	FILTER	86839170 / FA-4
NILFISK - ADVANCE /AMERICAN LINCOLN / CLARKE / KENT	56381349	SPLASHGUARD-32	86619820 / AD-32-S
NILFISK - ADVANCE /AMERICAN LINCOLN / CLARKE / KENT	56381416	CLAMP, CABLE KIT	86233360 / CHP-13
NILFISK - ADVANCE /AMERICAN LINCOLN / CLARKE / KENT	56381986	BLADE KIT, RED	98486660
NILFISK - ADVANCE /AMERICAN LINCOLN / CLARKE / KENT	56381986	BLADE KIT, RED	98486660
NILFISK - ADVANCE /AMERICAN LINCOLN / CLARKE / KENT	56382019	SPLASHGUARD	86718740 / AD-20-S
NILFISK - ADVANCE /AMERICAN LINCOLN / CLARKE / KENT	56382256	ALUMINUM CHANNEL (QBA) w/2x 23.5" RED-HA	86803110 / AD-20-C
NILFISK - ADVANCE /AMERICAN LINCOLN / CLARKE / KENT	56382356	SQUEEGEE BLADE CARTRIDGE 20"	86618650 / AD-20-CS
NILFISK - ADVANCE /AMERICAN LINCOLN / CLARKE / KENT	56382518	BLADE KIT, 28	98486670
NILFISK - ADVANCE /AMERICAN LINCOLN / CLARKE / KENT	56382519	BLADE KIT, TAN GUM 34"	98486680

Visit our website for the most current and complete OEM interchange



OEM	OEM Part #	Material Description	Graco Part # / Old Graco#
NILFISK - ADVANCE /AMERICAN LINCOLN / CLARKE / KENT	56382519	BLADE KIT, TAN GUM 34"	98486680
NILFISK - ADVANCE /AMERICAN LINCOLN / CLARKE / KENT	56382520	BLADE KIT, TAN GUM	98486590
NILFISK - ADVANCE /AMERICAN LINCOLN / CLARKE / KENT	56382795	GASKET	86804860 / AD-G-7
NILFISK - ADVANCE /AMERICAN LINCOLN / CLARKE / KENT	56382905	SPLASHGUARD, 200B	86619790 / AD-200-S
NILFISK - ADVANCE /AMERICAN LINCOLN / CLARKE / KENT	56384898	Filter VAC MOTOR	86003510 / FA-1
NILFISK - ADVANCE /AMERICAN LINCOLN / CLARKE / KENT	56384990	BLADE, GUM (QBA) 1-1/4"x1/8"/20-1/4" -6	86802790 / AD-17-4A
NILFISK - ADVANCE /AMERICAN LINCOLN / CLARKE / KENT	56384994	BLADE, NEO (QBA) 1-1/8"x1/16"20-1/4" -6	86802810 / AD-17-4C
NILFISK - ADVANCE /AMERICAN LINCOLN / CLARKE / KENT	56385032	SQ. CARTRIDGE	86700150 / AD-17-CS
NILFISK - ADVANCE /AMERICAN LINCOLN / CLARKE / KENT	56385055	GASKET SQUARE AD-G-8	86619210 / AD-G-8
NILFISK - ADVANCE /AMERICAN LINCOLN / CLARKE / KENT	56385168	(k) VAC. HOSE ASSEMBLY	98481010 / VHA-1
NILFISK - ADVANCE /AMERICAN LINCOLN / CLARKE / KENT	56385437	GASKET 56385437	86619270 / AD-G-10
NILFISK - ADVANCE /AMERICAN LINCOLN / CLARKE / KENT	56385615	(K)SWITCH EA-26 (SEE 29G010)	98480320 / EA-26
NILFISK - ADVANCE /AMERICAN LINCOLN / CLARKE / KENT	56386212	BATTERY CABLE-BCS618	86827850 / BCS618
NILFISK - ADVANCE /AMERICAN LINCOLN / CLARKE / KENT	56386215	BATTERY CABLE	86827860 / BCS624
NILFISK - ADVANCE /AMERICAN LINCOLN / CLARKE / KENT	56386386	GASKET(1/16X1/2X37)	86804740 / AD-G-52
NILFISK - ADVANCE /AMERICAN LINCOLN / CLARKE / KENT	56386450	(k) VALVE ASSY. W/ FITTINGS	98480960 / VA-17-B
NILFISK - ADVANCE /AMERICAN LINCOLN / CLARKE / KENT	56386725	CIRCUIT BREAKER 50 AMP (QBA)	86608520 / EA-50
NILFISK - ADVANCE /AMERICAN LINCOLN / CLARKE / KENT	56386963	Connector 175 DCA GRY W/O TERMS	88068250 / CHP-3
NILFISK - ADVANCE /AMERICAN LINCOLN / CLARKE / KENT	56386973	BATTERY CABLE	86827730 / BC436B
NILFISK - ADVANCE /AMERICAN LINCOLN / CLARKE / KENT	56386975	BATTERY CABLE	86827740 / BC436R
NILFISK - ADVANCE /AMERICAN LINCOLN / CLARKE / KENT	56387316	10 AMP BREAKER	86608930 / EA-72
NILFISK - ADVANCE /AMERICAN LINCOLN / CLARKE / KENT	56387328	CIRCUIT BREAKER 5A	86608220 / EA-51
NILFISK - ADVANCE /AMERICAN LINCOLN / CLARKE / KENT	56387376	(k) ROLLER ASSY (SQUEEGEE)	98480700 / SPA-5
NILFISK - ADVANCE /AMERICAN LINCOLN / CLARKE / KENT	56387526	SQUEEGEE CARTRIDGE-21	86618700 / AD-21-C
NILFISK - ADVANCE /AMERICAN LINCOLN / CLARKE / KENT	56388017	AMMETER, DC	86608650 / EAM-4
NILFISK - ADVANCE /AMERICAN LINCOLN / CLARKE / KENT	56388019	SWITCH EA-14	86616090 / EA-14
NILFISK - ADVANCE /AMERICAN LINCOLN / CLARKE / KENT	56388044	(k) BRUSH & SPRING KIT (MTO)	98480420 / EA-2000K
NILFISK - ADVANCE /AMERICAN LINCOLN / CLARKE / KENT	56388109	CHARGER 24V. 25A.40512A	86632150 / CH-32
NILFISK - ADVANCE /AMERICAN LINCOLN / CLARKE / KENT	56388402	BLADE RIGHT (QBA)	86803030 / AD-200-R
NILFISK - ADVANCE /AMERICAN LINCOLN / CLARKE / KENT	56388404	BLADE LEFT (QBA)	86802990
NILFISK - ADVANCE /AMERICAN LINCOLN / CLARKE / KENT	56388534	SOLENOID 36V.6POLE 788147	86607790 / EC-81
NILFISK - ADVANCE /AMERICAN LINCOLN / CLARKE / KENT	56388545	GRIP-HANDLE 290-1138	86608610 / GRA-2000
NILFISK - ADVANCE /AMERICAN LINCOLN / CLARKE / KENT	56388688	SPROCKET-DRIVE MOTOR 898550	86606570 / BLC-16
NILFISK - ADVANCE /AMERICAN LINCOLN / CLARKE / KENT	56389232	BATTERY CABLE (QBA)	86827880 / BCSN412
NILFISK - ADVANCE /AMERICAN LINCOLN / CLARKE / KENT	56389395	BRUSH SPRING SET/4	86844040 / MTA-3-2
NILFISK - ADVANCE /AMERICAN LINCOLN / CLARKE / KENT	56389420	PAD MOTOR - BURNISHER	86619520 / MTA-3
NILFISK - ADVANCE /AMERICAN LINCOLN / CLARKE / KENT	56389526	AMMETER, DC	86608650 / EAM-4
NILFISK - ADVANCE /AMERICAN LINCOLN / CLARKE / KENT	56389527	AMMETER, DC	86608650 / EAM-4
NILFISK - ADVANCE /AMERICAN LINCOLN / CLARKE / KENT	56390501	(k)VALVE 2-WAY W/FITTINGS	98480730 / VA-4-A
NILFISK - ADVANCE /AMERICAN LINCOLN / CLARKE / KENT	56390756	BLADE KIT, TAN GUM	98486590
NILFISK - ADVANCE /AMERICAN LINCOLN / CLARKE / KENT	56390788	BLADE KIT, TAN GUM	98486600
NILFISK - ADVANCE /AMERICAN LINCOLN / CLARKE / KENT	56390791	BLADE KIT, TAN GUM, CYL	98486610
NILFISK - ADVANCE /AMERICAN LINCOLN / CLARKE / KENT	56390796	BLADE KIT, TAN GUM	98486620
NILFISK - ADVANCE /AMERICAN LINCOLN / CLARKE / KENT	56391110	WHEEL 6", 3/8" BORE. GRAY RUBBER	88061520
NILFISK - ADVANCE /AMERICAN LINCOLN / CLARKE / KENT	56391161	(k) CONNECTOR ASSY	98480300 / CHP-18
NILFISK - ADVANCE /AMERICAN LINCOLN / CLARKE / KENT	56391185	BAG PK OF 6	86618220 / PBA-9
NILFISK - ADVANCE /AMERICAN LINCOLN / CLARKE / KENT	56391192	SQUEEGE BLADE, (QBA) ADVANCE, GUM	86803690 / AD-285-3A
NILFISK - ADVANCE /AMERICAN LINCOLN / CLARKE / KENT	56391250	SQUEEGEE SET (QBA)	98485070 / AD-285-3
NILFISK - ADVANCE /AMERICAN LINCOLN / CLARKE / KENT	56391261	SUEEGEE BLADE, (QBA) ADVANCE, NEO	86803700 / AD-285-3B
NILFISK - ADVANCE /AMERICAN LINCOLN / CLARKE / KENT	56391304	SPLASHGAURD, TRAC 280	86619780 / AD-320-S

Visit our website for the most current and complete OEM interchange



OEM	OEM Part #	Material Description	Graco Part # / Old Graco#
NILFISK - ADVANCE /AMERICAN LINCOLN / CLARKE / KENT	56391334	BLADE, GUM FRONT	86899070 / AD-285N-2A
NILFISK - ADVANCE /AMERICAN LINCOLN / CLARKE / KENT	56391340	BLADE KIT, STANDARD (QBA)	98485060 / AD-285N-2
NILFISK - ADVANCE /AMERICAN LINCOLN / CLARKE / KENT	56391697	HOSE ASSY. 48" GRAY	98486120
NILFISK - ADVANCE /AMERICAN LINCOLN / CLARKE / KENT	56391971	BLADE. R.H.	86618420 / AD-285-SR
NILFISK - ADVANCE /AMERICAN LINCOLN / CLARKE / KENT	56391972	SKIRT-L.H.	86618410 / AD-285-SL
NILFISK - ADVANCE /AMERICAN LINCOLN / CLARKE / KENT	56392097	SKIRT-L.H.56392097	86619650 / AD-325-SL
NILFISK - ADVANCE /AMERICAN LINCOLN / CLARKE / KENT	56392098	SKIRT,R.H.	86619640 / AD-325-SR
NILFISK - ADVANCE /AMERICAN LINCOLN / CLARKE / KENT	56392170	(k)VAC HOSE, 1.5"	98483280 / VHA-21
NILFISK - ADVANCE /AMERICAN LINCOLN / CLARKE / KENT	56392250	SQUEEGEE SET (QBA)	98485090 / AD-325-3
NILFISK - ADVANCE /AMERICAN LINCOLN / CLARKE / KENT	56392325	8X2 POLY WHEEL W/GRV	86626560 / WA-6-2
NILFISK - ADVANCE /AMERICAN LINCOLN / CLARKE / KENT	56392416	BLADE(LX) (QBA)	86803910 / AD-325-S
NILFISK - ADVANCE /AMERICAN LINCOLN / CLARKE / KENT	56392497	BELT 56392497	86618060 / BLA-70
NILFISK - ADVANCE /AMERICAN LINCOLN / CLARKE / KENT	56392721	BELT 392721	86618070 / BLA-72
NILFISK - ADVANCE /AMERICAN LINCOLN / CLARKE / KENT	56392739	BLADE, GUM (QBA) 2-1/2"x3/16"x46-1/8" -	86803880 / AD-325-3A
NILFISK - ADVANCE /AMERICAN LINCOLN / CLARKE / KENT	56392740	BLADE, NEO (QBA) 2-5/16"x1/8"x45-1/8" -1	86803890 / AD-325-3B
NILFISK - ADVANCE /AMERICAN LINCOLN / CLARKE / KENT	56392741	BLADE, NEO (QBA) 1-3/4"x18"x46" - 8 Hole	86803900 / AD-325-3C
NILFISK - ADVANCE /AMERICAN LINCOLN / CLARKE / KENT	56393172	(k)DRIVE CHAIN	98480060 / BLA-87
NILFISK - ADVANCE /AMERICAN LINCOLN / CLARKE / KENT	56393181	INLET FILTER	86652530 / FC-62
NILFISK - ADVANCE /AMERICAN LINCOLN / CLARKE / KENT	56393285	SQ BLADE, GUM, FRONT	86619720 / AD-240-2B
NILFISK - ADVANCE /AMERICAN LINCOLN / CLARKE / KENT	56393312	Switch DPDT 2-POSITION ROCKER	86007130 / EA-81
NILFISK - ADVANCE /AMERICAN LINCOLN / CLARKE / KENT	56393395	SQUEEGEE SET (QBA)	98485040 / AD-240-2
NILFISK - ADVANCE /AMERICAN LINCOLN / CLARKE / KENT	56393565	STRIP-SKIRT 56393565	86619880
NILFISK - ADVANCE /AMERICAN LINCOLN / CLARKE / KENT	56393567	CENTER PAD HOLDER L.H.56393567	86633810 / PH-6-L
NILFISK - ADVANCE /AMERICAN LINCOLN / CLARKE / KENT	56393568	Connector 175 DCA GRY W/O TERMS	88068250 / CHP-3
NILFISK - ADVANCE /AMERICAN LINCOLN / CLARKE / KENT	56393718	METER, HOUR	86619490 / EA-83
NILFISK - ADVANCE /AMERICAN LINCOLN / CLARKE / KENT	56395101	CHARGER 36V 20A AUTO.56395101	86738030 / CH-63
NILFISK - ADVANCE /AMERICAN LINCOLN / CLARKE / KENT	56395222	8X2 POLY WHEEL W/GRV	86626560 / WA-6-2
NILFISK - ADVANCE /AMERICAN LINCOLN / CLARKE / KENT	56395233	WHEEL 8 X 2 (1" BORE W/KEYWAY,2.5" HUB)	86620180 / WA-9-2
NILFISK - ADVANCE /AMERICAN LINCOLN / CLARKE / KENT	56395450	Relay 36VDC 100AMP HVY DUTY	86006370 / EA-80
NILFISK - ADVANCE /AMERICAN LINCOLN / CLARKE / KENT	56395452	SOLENOID 36V.56395452,	86606490 / EC-43
NILFISK - ADVANCE /AMERICAN LINCOLN / CLARKE / KENT	56395454	CIRCUIT BREAKER 20 AMP (QBA)	86609750 / EA-33
NILFISK - ADVANCE /AMERICAN LINCOLN / CLARKE / KENT	56395633	SPLASHGUARG (LEFT) (QBA)	86802940 / AD-18-SL
NILFISK - ADVANCE /AMERICAN LINCOLN / CLARKE / KENT	56395684	SPLASHGUARD (RIGHT) (QBA)	86802950 / AD-18-SR
NILFISK - ADVANCE /AMERICAN LINCOLN / CLARKE / KENT	56395755	Rod End	86728670
NILFISK - ADVANCE /AMERICAN LINCOLN / CLARKE / KENT	56395793	CARTRIDGE,32N	86618640 / AD-32N-C
NILFISK - ADVANCE /AMERICAN LINCOLN / CLARKE / KENT	56395799	CARTRIDGE HARD (QBA)	86804280 / AD-38N-C
NILFISK - ADVANCE /AMERICAN LINCOLN / CLARKE / KENT	56395871	(k) CHAIN	98480050 / BLA-86
NILFISK - ADVANCE /AMERICAN LINCOLN / CLARKE / KENT	56395875	VAC MOTOR 56395875	86854620 / VM-27
NILFISK - ADVANCE /AMERICAN LINCOLN / CLARKE / KENT	56395882	VAC MOTOR 56395875	86854620 / VM-27
NILFISK - ADVANCE /AMERICAN LINCOLN / CLARKE / KENT	56395970	BELT	86618340 / BLA-28
NILFISK - ADVANCE /AMERICAN LINCOLN / CLARKE / KENT	56396004	SKIRT BLADE RIGHT	86856980
NILFISK - ADVANCE /AMERICAN LINCOLN / CLARKE / KENT	56396005	SKIRT BLADE LEFT	86856970
NILFISK - ADVANCE /AMERICAN LINCOLN / CLARKE / KENT	56396172	SQUEEGEE BLADE KIT, (QBA) LINATEX	98486020 / AD-285R-2
NILFISK - ADVANCE /AMERICAN LINCOLN / CLARKE / KENT	56396287	(K) HOSE, DRAIN (68.5" WHT HOSE W/2 CUFF	98481780 / VHA-18
NILFISK - ADVANCE /AMERICAN LINCOLN / CLARKE / KENT	56397014	SKIRT RIGHT	86618570
NILFISK - ADVANCE /AMERICAN LINCOLN / CLARKE / KENT	56397016	WHEEL CASTER 56206725	86608720 / WA-3
NILFISK - ADVANCE /AMERICAN LINCOLN / CLARKE / KENT	56397016	SWIVEL CASTER (3.5" POLY WHEEL)	88054280
NILFISK - ADVANCE /AMERICAN LINCOLN / CLARKE / KENT	56397019	BLADES	86696760
NILFISK - ADVANCE /AMERICAN LINCOLN / CLARKE / KENT	56397041	24 VOLT 3 STAGE VAC MOTOR	86854780 / VM-34
NILFISK - ADVANCE /AMERICAN LINCOLN / CLARKE / KENT	56397042	24 VOLT 3 STAGE VAC MOTOR	86854780 / VM-34

Visit our website for the most current and complete OEM interchange



OEM	OEM Part #	Material Description	Graco Part # / Old Graco#
NILFISK - ADVANCE /AMERICAN LINCOLN / CLARKE / KENT	56397088	SOLENOID MAIN	86648780 / EC-97
NILFISK - ADVANCE /AMERICAN LINCOLN / CLARKE / KENT	56397091	BLADE, REAR LINATEX (QBA)	86804090 / AD-34R-2A
NILFISK - ADVANCE /AMERICAN LINCOLN / CLARKE / KENT	56397094	SQUEEGEE SET GUM(ADV) (QBA)	98485240 / AD-34-2
NILFISK - ADVANCE /AMERICAN LINCOLN / CLARKE / KENT	56397106	BLADE SET, LINATEX (QBA)	98485860 / AD-34R-2
NILFISK - ADVANCE /AMERICAN LINCOLN / CLARKE / KENT	56397142	(K) DRAIN HOSE ASSY.	98482090 / VHA-20
NILFISK - ADVANCE /AMERICAN LINCOLN / CLARKE / KENT	56397203	Valve 24VDC SOL.1/2"HOSEBARB	86010540 / VWN-1
NILFISK - ADVANCE /AMERICAN LINCOLN / CLARKE / KENT	56397228	VAC MOTOR ASM, 36VDC 3 STAGE	86005450 / VM-30A+
NILFISK - ADVANCE /AMERICAN LINCOLN / CLARKE / KENT	56397250	SOLENOID 36v 41802A - etn16	86620760 / ETN-16
NILFISK - ADVANCE /AMERICAN LINCOLN / CLARKE / KENT	56397307	GASKET,VACUUM 873403	86606240 / C-G-1
NILFISK - ADVANCE /AMERICAN LINCOLN / CLARKE / KENT	56397316	Motor 36VDC 200RPM 3/4HP GEAR	86005340 / F755400A+
NILFISK - ADVANCE /AMERICAN LINCOLN / CLARKE / KENT	56397362	BLADE, FRONT NOTCHED GUM (QBA)	86804070 / AD-34-2B
NILFISK - ADVANCE /AMERICAN LINCOLN / CLARKE / KENT	56397363	BLADE, REAR GUM(ADV) (QBA)	86804060 / AD-34-2A
NILFISK - ADVANCE /AMERICAN LINCOLN / CLARKE / KENT	56398090	BATTERY CABLE (QBA)	86827880 / BCSN412
NILFISK - ADVANCE /AMERICAN LINCOLN / CLARKE / KENT	56400289	SPLASHGUARD BLADE (QBA)	86804310 / AD-38-S
NILFISK - ADVANCE /AMERICAN LINCOLN / CLARKE / KENT	56400558	BLADE, TAN GUM (QBA) 1-3/8"x1/8"x42-15/1	86804200 / AD-38-4A
NILFISK - ADVANCE /AMERICAN LINCOLN / CLARKE / KENT	56400566	BLADE, NEO (QBA) 1-1/4"x1/8"x42-15/16" -	86804210 / AD-38-4B
NILFISK - ADVANCE /AMERICAN LINCOLN / CLARKE / KENT	56400574	BLADE, NEO (QBA) 11/8"x1/16"x42-15/16" -	86804220 / AD-38-4C
NILFISK - ADVANCE /AMERICAN LINCOLN / CLARKE / KENT	56400588	SQUEEGEE SET NEO	98485910 / AD-38-4N
NILFISK - ADVANCE /AMERICAN LINCOLN / CLARKE / KENT	56400612	SQUEEGEE CART 40"	86658150 / AD-38-C
NILFISK - ADVANCE /AMERICAN LINCOLN / CLARKE / KENT	56400613	GASKET SQ. WELDMENT	86619260 / AD-G-96
NILFISK - ADVANCE /AMERICAN LINCOLN / CLARKE / KENT	56400614	GASKET	86805050 / AD-G-99
NILFISK - ADVANCE /AMERICAN LINCOLN / CLARKE / KENT	56403172	(k)CHAIN	98480030 / BLA-84
NILFISK - ADVANCE /AMERICAN LINCOLN / CLARKE / KENT	56404095	SQUEEGEE SET-38BHD (QBA)	98485920 / AD-38HD-3
NILFISK - ADVANCE /AMERICAN LINCOLN / CLARKE / KENT	56407447	BLADE, SCRUB DECK SQUEEGEE	86697060 / AD-CYL-S
NILFISK - ADVANCE /AMERICAN LINCOLN / CLARKE / KENT	56407465	BELT	86617860 / BLA-26
NILFISK - ADVANCE /AMERICAN LINCOLN / CLARKE / KENT	56407589	BLADE KIT (QBA)	98486030 / AD-3800NG-2
NILFISK - ADVANCE /AMERICAN LINCOLN / CLARKE / KENT	56407602	BLADE KIT, NEO (QBA)	86858750 / AD-3800NN-2
NILFISK - ADVANCE /AMERICAN LINCOLN / CLARKE / KENT	56409103	SPLASHGUARD-3800	86619620 / AD-3800-S
NILFISK - ADVANCE /AMERICAN LINCOLN / CLARKE / KENT	56409413	SQ. BLADE REAR	86620000 / AD-3800-2B
NILFISK - ADVANCE /AMERICAN LINCOLN / CLARKE / KENT	56409429	SQUEEGEE SET (QBA) gum	98485080 / AD-3800-2
NILFISK - ADVANCE /AMERICAN LINCOLN / CLARKE / KENT	56409627	FRONT SQ BLADE	86713870 / AD-3800-2A
NILFISK - ADVANCE /AMERICAN LINCOLN / CLARKE / KENT	56409705	36 VOLT 3 STAGE VAC MOTOR	86854650 / VM-280
NILFISK - ADVANCE /AMERICAN LINCOLN / CLARKE / KENT	56410065	Vac motor assy	98486870
NILFISK - ADVANCE /AMERICAN LINCOLN / CLARKE / KENT	56410335	SKIRT, CYLINDRICAL SCRUB HEAD, 1/4" LINA	86804490 / AD-CYL-R-S
NILFISK - ADVANCE /AMERICAN LINCOLN / CLARKE / KENT	56411643	CHARGER 12V	86717090 / CH-44
NILFISK - ADVANCE /AMERICAN LINCOLN / CLARKE / KENT	56412029	FRONT BLADE, (QBA) HYDRO RETRIEVER 2800	86803600 / AD-2800-2B
NILFISK - ADVANCE /AMERICAN LINCOLN / CLARKE / KENT	56412030	REAR BLADE, (QBA) HYDRORETRIEVER 2800	86803590 / AD-2800-2A
NILFISK - ADVANCE /AMERICAN LINCOLN / CLARKE / KENT	56412089	FUSE 150AMP	86720340 / EA-93
NILFISK - ADVANCE /AMERICAN LINCOLN / CLARKE / KENT	56412124	SQ WHEEL W/HARDWARE	98486780
NILFISK - ADVANCE /AMERICAN LINCOLN / CLARKE / KENT	56412154	GASKET, 1/4" ROUND VACUUM DUCT	86857060
NILFISK - ADVANCE /AMERICAN LINCOLN / CLARKE / KENT	56412218	24 VOLT 3 STAGE VAC MOTOR	86854550 / VM-23
NILFISK - ADVANCE /AMERICAN LINCOLN / CLARKE / KENT	56412265	SQUEEGEE BLADE SET (QBA)	98485220 / AD-2800-2
NILFISK - ADVANCE /AMERICAN LINCOLN / CLARKE / KENT	56413056	BROOM, SIDE, 18" POLY W/ADAPTOR	88057030
NILFISK - ADVANCE /AMERICAN LINCOLN / CLARKE / KENT	56413113	BRUSH, SOFT NYLON 40"	88057200
NILFISK - ADVANCE /AMERICAN LINCOLN / CLARKE / KENT	56413114	BRUSH, HARD NYLON 40"	88057210
NILFISK - ADVANCE /AMERICAN LINCOLN / CLARKE / KENT	56413115	BRUSH 40" 180 GRIT	88056980
NILFISK - ADVANCE /AMERICAN LINCOLN / CLARKE / KENT	56413116	BRUSH, 80 GRIT 40"	88057220
NILFISK - ADVANCE /AMERICAN LINCOLN / CLARKE / KENT	56413118	BRUSH 40" PROLENE	88056970
NILFISK - ADVANCE /AMERICAN LINCOLN / CLARKE / KENT	56413352	BRUSH, SOFT NYLON 48"	88057260
NILFISK - ADVANCE /AMERICAN LINCOLN / CLARKE / KENT	56413353	BRUSH, HARD NYLON 48"	88057270

Visit our website for the most current and complete OEM interchange



OEM	OEM Part #	Material Description	Graco Part # / Old Graco#
NILFISK - ADVANCE /AMERICAN LINCOLN / CLARKE / KENT	56413354	BRUSH 48" 180 GRIT	88057020
NILFISK - ADVANCE /AMERICAN LINCOLN / CLARKE / KENT	56413355	BRUSH, 80 GRIT 48"	88057280
NILFISK - ADVANCE /AMERICAN LINCOLN / CLARKE / KENT	56413357	BRUSH 48" POLY	88057010
NILFISK - ADVANCE /AMERICAN LINCOLN / CLARKE / KENT	56413434	BRUSH, SOFT NYLON 45"	88057230
NILFISK - ADVANCE /AMERICAN LINCOLN / CLARKE / KENT	56413435	BRUSH, HARD NYLON 45"	88057240
NILFISK - ADVANCE /AMERICAN LINCOLN / CLARKE / KENT	56413436	BRUSH 45" 180 GRIT	88057000
NILFISK - ADVANCE /AMERICAN LINCOLN / CLARKE / KENT	56413437	BRUSH, 80 GRIT 45"	88057250
NILFISK - ADVANCE /AMERICAN LINCOLN / CLARKE / KENT	56413439	BRUSH 45" POLY	88056990
NILFISK - ADVANCE /AMERICAN LINCOLN / CLARKE / KENT	56420120	CENTERLOCK-PAD HOLDER	86633860 / PH-7
NILFISK - ADVANCE /AMERICAN LINCOLN / CLARKE / KENT	56440450	WHEEL 6 X 1-1/2	86634680 / WA-28
NILFISK - ADVANCE /AMERICAN LINCOLN / CLARKE / KENT	56441538	SWITCH,KEY 56441538	86612660 / EAL-1
NILFISK - ADVANCE /AMERICAN LINCOLN / CLARKE / KENT	56444308	PILLOW BLOCK BEARING	86602510 / NSS-B-1
NILFISK - ADVANCE /AMERICAN LINCOLN / CLARKE / KENT	56445096	40 LINK,CONN.	86633920 / BLAL-9
NILFISK - ADVANCE /AMERICAN LINCOLN / CLARKE / KENT	56448677	METER-BATT.COND. 56448677	86608640 / EAM-3
NILFISK - ADVANCE /AMERICAN LINCOLN / CLARKE / KENT	56448729	(k) CARBON BRUSHES(4 PER SET)	98480340 / EA-4
NILFISK - ADVANCE /AMERICAN LINCOLN / CLARKE / KENT	56454209	BLADE, TAN GUM (QBA) 2-1/2"x1/4"x62" -15	86804350 / AD-5000-4A
NILFISK - ADVANCE /AMERICAN LINCOLN / CLARKE / KENT	56454215	BLADE, NEO (QBA) 2"x1/8"x60-3/4" -15 Hol	86804360 / AD-5000-4B
NILFISK - ADVANCE /AMERICAN LINCOLN / CLARKE / KENT	56454218	BLADE, NEO (QBA) 2"x3/16"x52-3/8" -11 Ho	86804440 / AD-50-4C
NILFISK - ADVANCE /AMERICAN LINCOLN / CLARKE / KENT	56454335	VAC MOTOR	86623200 / VM-42
NILFISK - ADVANCE /AMERICAN LINCOLN / CLARKE / KENT	56454423	BREAKER, 30A 50VDC CIRCUIT - VAC MOTOR	86001910 / EA-29
NILFISK - ADVANCE /AMERICAN LINCOLN / CLARKE / KENT	56454429	CIRCUIT BREAKER-70 AMP	86608530 / EA-70
NILFISK - ADVANCE /AMERICAN LINCOLN / CLARKE / KENT	56454538	15A.CIRCUIT BRK.740130	86618740 / EA-34
NILFISK - ADVANCE /AMERICAN LINCOLN / CLARKE / KENT	56454740	POTENTIOMETER -	86643040 / EA-90
NILFISK - ADVANCE /AMERICAN LINCOLN / CLARKE / KENT	56455606	BLADE, URETHANE (QBA) 2"x1/4"x56-3/4" -13	86804380 / AD-5000-4D
NILFISK - ADVANCE /AMERICAN LINCOLN / CLARKE / KENT	56455608	BLADE, TAN GUM (QBA) 2-1/4"x3/16"x57-3/4	86804370 / AD-5000-4C
NILFISK - ADVANCE /AMERICAN LINCOLN / CLARKE / KENT	56456458	BATTERY CABLE	86827890 / BCSN415
NILFISK - ADVANCE /AMERICAN LINCOLN / CLARKE / KENT	56456460	BATTERY CABLE	86827890 / BCSN415
NILFISK - ADVANCE /AMERICAN LINCOLN / CLARKE / KENT	56459253	Plug 1-3/4 DRAIN HOSE	86006340 / VAL-4
NILFISK - ADVANCE /AMERICAN LINCOLN / CLARKE / KENT	56460217	VAC MOTOR	86623200 / VM-42
NILFISK - ADVANCE /AMERICAN LINCOLN / CLARKE / KENT	56462252	BROOM,SIDE POLY	88056270
NILFISK - ADVANCE /AMERICAN LINCOLN / CLARKE / KENT	56462362	VAC. SWITCH	86618030 / EA-86
NILFISK - ADVANCE /AMERICAN LINCOLN / CLARKE / KENT	56465430	BELT	86618340 / BLA-28
NILFISK - ADVANCE /AMERICAN LINCOLN / CLARKE / KENT	56467208	SKIRT	86805110 / AD-LV-6
NILFISK - ADVANCE /AMERICAN LINCOLN / CLARKE / KENT	56467306	SKIRT	86805140 / AD-LV-9
NILFISK - ADVANCE /AMERICAN LINCOLN / CLARKE / KENT	56467330	SKIRT	86805140 / AD-LV-9
NILFISK - ADVANCE /AMERICAN LINCOLN / CLARKE / KENT	56467410	LIGHT INDICATOR - ADVANCE	86608630 / APL-1
NILFISK - ADVANCE /AMERICAN LINCOLN / CLARKE / KENT	56468358	SOLENOID 24 VOLT 878514,788147	86606480 / EC-1
NILFISK - ADVANCE /AMERICAN LINCOLN / CLARKE / KENT	56468575	GASKET 3/16 X 1/2 X 130"	86804930 / AD-G-81
NILFISK - ADVANCE /AMERICAN LINCOLN / CLARKE / KENT	56468884	(k) CHAIN	98480000 / BLA-83
NILFISK - ADVANCE /AMERICAN LINCOLN / CLARKE / KENT	56469788	CIRCUIT BREAKER 25A (QBA) *	86608290 / ETN-4
NILFISK - ADVANCE /AMERICAN LINCOLN / CLARKE / KENT	56470582	WHEEL 6 X 1-1/2	86634680 / WA-28
NILFISK - ADVANCE /AMERICAN LINCOLN / CLARKE / KENT	56471194	LATCH ASSEMBLY	86619320
NILFISK - ADVANCE /AMERICAN LINCOLN / CLARKE / KENT	56471258	GASKET (1/4X7/8X24 IN)	86804620 / AD-G-20
NILFISK - ADVANCE /AMERICAN LINCOLN / CLARKE / KENT	56471354	GASKET (1/4X7/8X24 IN)	86804620 / AD-G-20
NILFISK - ADVANCE /AMERICAN LINCOLN / CLARKE / KENT	56471358	GASKET (1/4X7/8X24 IN)	86804620 / AD-G-20
NILFISK - ADVANCE /AMERICAN LINCOLN / CLARKE / KENT	56473266	1/4 X 1/2 X 72	86804970 / AD-G-90
NILFISK - ADVANCE /AMERICAN LINCOLN / CLARKE / KENT	56473435	GASKET 1/4 X 1/2 X 93"	86804980 / AD-G-91
NILFISK - ADVANCE /AMERICAN LINCOLN / CLARKE / KENT	56474645	BLADE, TAN GUM (QBA) 1-3/8"x1/8"x38-15/1	86803820 / AD-32-4A
NILFISK - ADVANCE /AMERICAN LINCOLN / CLARKE / KENT	56474647	BLADE, NEO (QBA) 1-1/4"x1/8"x38-15/16" -	86803830 / AD-32-4B
NILFISK - ADVANCE /AMERICAN LINCOLN / CLARKE / KENT	56474650	BLADE, NEO1-1/8"x1/16"x38-15/16"-12 Hole	86803840 / AD-32-4C

Visit our website for the most current and complete OEM interchange



OEM	OEM Part #	Material Description	Graco Part # / Old Graco#
NILFISK - ADVANCE /AMERICAN LINCOLN / CLARKE / KENT	56474688	GASKET 1/4 X 1/2 X 93"	86804990 / AD-G-92
NILFISK - ADVANCE /AMERICAN LINCOLN / CLARKE / KENT	56474690	GASKET 1/4 X 1/2 X 44"	86805000 / AD-G-93
NILFISK - ADVANCE /AMERICAN LINCOLN / CLARKE / KENT	56474692	GASKET 1/4 X 1/2 X 93"	86804990 / AD-G-92
NILFISK - ADVANCE /AMERICAN LINCOLN / CLARKE / KENT	56475334	SKIRT HOPPER	86805070 / AD-LV-2
NILFISK - ADVANCE /AMERICAN LINCOLN / CLARKE / KENT	56478980	GASKET 1/4 X 1/2 X 132"	86805010 / AD-G-95
NILFISK - ADVANCE /AMERICAN LINCOLN / CLARKE / KENT	56479430	BEARING, BALL (6205-2RS)	86626370 / MC-1-B
NILFISK - ADVANCE /AMERICAN LINCOLN / CLARKE / KENT	56483116	SWITCH, ROCKER 56324272 ***SEE NOTE***	86620040 / EA-84
NILFISK - ADVANCE /AMERICAN LINCOLN / CLARKE / KENT	56505195	Lock PAD CENTER SNAP,TWO STEP	86005070 / PH-8
NILFISK - ADVANCE /AMERICAN LINCOLN / CLARKE / KENT	56505455	PAD DRIVER 19"	86619530 / BRA-20-AG
NILFISK - ADVANCE /AMERICAN LINCOLN / CLARKE / KENT	56505780	PAD DRIVER ASSY-17" SHORT TRIM	88056410
NILFISK - ADVANCE /AMERICAN LINCOLN / CLARKE / KENT	56505781	BRUSH-17" MAGNA GRIT 46	88056430
NILFISK - ADVANCE /AMERICAN LINCOLN / CLARKE / KENT	56505782	BRUSH-17" DYNA GRIT 80	88056390
NILFISK - ADVANCE /AMERICAN LINCOLN / CLARKE / KENT	56505783	BRUSH-17" AGLITE GRIT 500	88056450
NILFISK - ADVANCE /AMERICAN LINCOLN / CLARKE / KENT	56505784	BRUSH-17" PROLENE	88056380
NILFISK - ADVANCE /AMERICAN LINCOLN / CLARKE / KENT	56505785	BRUSH-17"PROLITE	88056420
NILFISK - ADVANCE /AMERICAN LINCOLN / CLARKE / KENT	56505786	BRUSH-17" UNION MIX	88056370
NILFISK - ADVANCE /AMERICAN LINCOLN / CLARKE / KENT	56505787	BRUSH-17" MIDGRIT 240	88056400
NILFISK - ADVANCE /AMERICAN LINCOLN / CLARKE / KENT	56505788	BRUSH-17" MIDLITE GRIT 180	88056440
NILFISK - ADVANCE /AMERICAN LINCOLN / CLARKE / KENT	56505790	PAD HOLDER ASS'Y.	86829280 / BRA-21-L
NILFISK - ADVANCE /AMERICAN LINCOLN / CLARKE / KENT	56505790	PAD DRIVER ASSY-20" SHORT TRIM	88056910
NILFISK - ADVANCE /AMERICAN LINCOLN / CLARKE / KENT	56505791	DISC BRUSH-20" MAGNAGRIT	88057080
NILFISK - ADVANCE /AMERICAN LINCOLN / CLARKE / KENT	56505792	DISC BRUSH-20" DYNAGRIT	88057090
NILFISK - ADVANCE /AMERICAN LINCOLN / CLARKE / KENT	56505793	DISC BRUSH-20" AGLITE	88057100
NILFISK - ADVANCE /AMERICAN LINCOLN / CLARKE / KENT	56505794	DISC BRUSH-20" PROLENE	88056920
NILFISK - ADVANCE /AMERICAN LINCOLN / CLARKE / KENT	56505795	DISC BRUSH-20" PROLITE	88057110
NILFISK - ADVANCE /AMERICAN LINCOLN / CLARKE / KENT	56505796	DISC BRUSH-20" UNION MIX	88057120
NILFISK - ADVANCE /AMERICAN LINCOLN / CLARKE / KENT	56505797	DISC BRUSH-20" MIDGRIT	88056930
NILFISK - ADVANCE /AMERICAN LINCOLN / CLARKE / KENT	56505798	DISC BRUSH-20" MIDLITE GRIT	88057130
NILFISK - ADVANCE /AMERICAN LINCOLN / CLARKE / KENT	56505800	PAD DRIVER ASSY-14" SHORT TRIM	88056500
NILFISK - ADVANCE /AMERICAN LINCOLN / CLARKE / KENT	56505801	BRUSH-14" MAGNA GRIT 46	88056520
NILFISK - ADVANCE /AMERICAN LINCOLN / CLARKE / KENT	56505802	BRUSH-14" DYNA GRIT 80	88056480
NILFISK - ADVANCE /AMERICAN LINCOLN / CLARKE / KENT	56505803	BRUSH-14" AGLITE GRIT 500	88056540
NILFISK - ADVANCE /AMERICAN LINCOLN / CLARKE / KENT	56505804	BRUSH-14" PROLENE	88056470
NILFISK - ADVANCE /AMERICAN LINCOLN / CLARKE / KENT	56505805	BRUSH-14"PROLITE	88056510
NILFISK - ADVANCE /AMERICAN LINCOLN / CLARKE / KENT	56505806	BRUSH-14" UNION MIX	88056460
NILFISK - ADVANCE /AMERICAN LINCOLN / CLARKE / KENT	56505807	BRUSH-14" MIDGRIT 240	88056490
NILFISK - ADVANCE /AMERICAN LINCOLN / CLARKE / KENT	56505808	BRUSH-14" MIDLITE GRIT 180	88056530
NILFISK - ADVANCE /AMERICAN LINCOLN / CLARKE / KENT	56505830	PAD DRIVER 16"	88056940 / BRN-33-AG
NILFISK - ADVANCE /AMERICAN LINCOLN / CLARKE / KENT	56505831	DISC BRUSH-16" MAGNAGRIT	88057140
NILFISK - ADVANCE /AMERICAN LINCOLN / CLARKE / KENT	56505832	DISC BRUSH-16" DYNAGRIT	88057150
NILFISK - ADVANCE /AMERICAN LINCOLN / CLARKE / KENT	56505833	DISC BRUSH-16" AGLITE	88057160
NILFISK - ADVANCE /AMERICAN LINCOLN / CLARKE / KENT	56505834	DISC BRUSH-16" PROLENE	88056950
NILFISK - ADVANCE /AMERICAN LINCOLN / CLARKE / KENT	56505835	DISC BRUSH-16" PROLITE	88057170
NILFISK - ADVANCE /AMERICAN LINCOLN / CLARKE / KENT	56505836	DISC BRUSH-16" UNION MIX	88057180
NILFISK - ADVANCE /AMERICAN LINCOLN / CLARKE / KENT	56505837	DISC BRUSH-16" MIDGRIT	88056960
NILFISK - ADVANCE /AMERICAN LINCOLN / CLARKE / KENT	56505838	DISC BRUSH-16" MIDLITE GRIT	88057190
NILFISK - ADVANCE /AMERICAN LINCOLN / CLARKE / KENT	56505940	PAD DRIVER ASSY-15" SHORT TRIM	88056320
NILFISK - ADVANCE /AMERICAN LINCOLN / CLARKE / KENT	56505941	BRUSH-15" MAGNA GRIT 46	88056340
NILFISK - ADVANCE /AMERICAN LINCOLN / CLARKE / KENT	56505942	BRUSH-15" DYNA GRIT 80	88056300
NILFISK - ADVANCE /AMERICAN LINCOLN / CLARKE / KENT	56505943	BRUSH-15" AGLITE GRIT 500	88056360

Visit our website for the most current and complete OEM interchange



OEM	OEM Part #	Material Description	Graco Part # / Old Graco#
NILFISK - ADVANCE /AMERICAN LINCOLN / CLARKE / KENT	56505944	BRUSH-15" PROLENE	88056290
NILFISK - ADVANCE /AMERICAN LINCOLN / CLARKE / KENT	56505945	BRUSH-15" PROLITE	88056330
NILFISK - ADVANCE /AMERICAN LINCOLN / CLARKE / KENT	56505946	BRUSH-15" UNION MIX	88056280
NILFISK - ADVANCE /AMERICAN LINCOLN / CLARKE / KENT	56505947	BRUSH-15" MID GRIT 120	88056310
NILFISK - ADVANCE /AMERICAN LINCOLN / CLARKE / KENT	56505948	BRUSH-15" MIDLITE GRIT 180	88056350
NILFISK - ADVANCE /AMERICAN LINCOLN / CLARKE / KENT	56505951	BROOM,MAIN POLY/WIRE,8 DOUBLE ROWS	88056260
NILFISK - ADVANCE /AMERICAN LINCOLN / CLARKE / KENT	56505953	BROOM,MAIN NYLON,8 DOUBLE ROWS	88056230
NILFISK - ADVANCE /AMERICAN LINCOLN / CLARKE / KENT	56505954	BROOM,MAIN PROEX,8 DOUBLE ROWS	88056250
NILFISK - ADVANCE /AMERICAN LINCOLN / CLARKE / KENT	56505955	BROOM,MAIN PROEX/WIRE,8 DOUBLE ROWS	88056210
NILFISK - ADVANCE /AMERICAN LINCOLN / CLARKE / KENT	56505956	BROOM,MAIN PROLENE,8 DOUBLE ROWS	88056220
NILFISK - ADVANCE /AMERICAN LINCOLN / CLARKE / KENT	56507340	BROOM, MAIN PROEX-WIRE (CHEVRON)	88055850
NILFISK - ADVANCE /AMERICAN LINCOLN / CLARKE / KENT	56507341	BROOM, MAIN PROEX, 12 DOUBLE ROWS	88055880
NILFISK - ADVANCE /AMERICAN LINCOLN / CLARKE / KENT	56507342	BROOM,MAIN PROEX-WIRE,12 DOUBLE ROWS	88055860
NILFISK - ADVANCE /AMERICAN LINCOLN / CLARKE / KENT	56507343	BROOM, MAIN POLY,8 DOUBLE ROWS	88055910
NILFISK - ADVANCE /AMERICAN LINCOLN / CLARKE / KENT	56507344	BROOM, MAIN POLY/WIRE,12 DOUBLE ROWS	88055900
NILFISK - ADVANCE /AMERICAN LINCOLN / CLARKE / KENT	56507345	BROOM, MAIN NYLON,8 DOUBLE ROWS	88055870
NILFISK - ADVANCE /AMERICAN LINCOLN / CLARKE / KENT	56507346	BROOM, MAIN PROEX, 8 DOUBLE ROWS	88055890
NILFISK - ADVANCE /AMERICAN LINCOLN / CLARKE / KENT	56507350	BROOM, SIDE, POLY	88055920
NILFISK - ADVANCE /AMERICAN LINCOLN / CLARKE / KENT	56507351	BROOM, SIDE, NYLON 30DEG.	88055930
NILFISK - ADVANCE /AMERICAN LINCOLN / CLARKE / KENT	56507352	BROOM, SIDE, WIRE 30DEG.	88055940
NILFISK - ADVANCE /AMERICAN LINCOLN / CLARKE / KENT	56507424	BROOM, MAIN PROEX-WIRE	88055840
NILFISK - ADVANCE /AMERICAN LINCOLN / CLARKE / KENT	56508498	BROOM, SIDE, POLY 41 DEG.	88055950
NILFISK - ADVANCE /AMERICAN LINCOLN / CLARKE / KENT	56508499	BROOM, SIDE, NYLON 41 DEG.	88055960
NILFISK - ADVANCE /AMERICAN LINCOLN / CLARKE / KENT	56514859	SIDE BLADE KIT	98486710
NILFISK - ADVANCE /AMERICAN LINCOLN / CLARKE / KENT	56514860	BLADE KIT,RED,REAR SKIRT SQUEEGEE	98486630
NILFISK - ADVANCE /AMERICAN LINCOLN / CLARKE / KENT	56515817	BLADE KIT, SIDE	98486640
NILFISK - ADVANCE /AMERICAN LINCOLN / CLARKE / KENT	56515818	BLADE KIT, FRONT/REAR	98486650
NILFISK - ADVANCE /AMERICAN LINCOLN / CLARKE / KENT	56550823	BLADE, NEO1-1/4"x1/8"x31-15/16" - 9 Holes	86803440 / AD-26-4B
NILFISK - ADVANCE /AMERICAN LINCOLN / CLARKE / KENT	56550825	BLADE, NEO 1-1/8"x1/16"x31-15/16"- 9 Hol	86803450 / AD-26-4C
NILFISK - ADVANCE /AMERICAN LINCOLN / CLARKE / KENT	56550827	BLADE, GUM 1-3/8"x1/8"x31-15/16" - 9 Hol	86803420 / AD-26-4A
NILFISK - ADVANCE /AMERICAN LINCOLN / CLARKE / KENT	56550941	(k) VACUUM HOSE ASSEMBLY	98481080 / VHA-6
NILFISK - ADVANCE /AMERICAN LINCOLN / CLARKE / KENT	56550950	SQUEEGEE SET (QBA)	98485820 / AD-26-4
NILFISK - ADVANCE /AMERICAN LINCOLN / CLARKE / KENT	56550952	SQUEEGEE SET (NEO) (QBA)	86803460 / AD-26-4N
NILFISK - ADVANCE /AMERICAN LINCOLN / CLARKE / KENT	56551127	SPLASH GUARD 56551127	86619810 / AD-26-S
NILFISK - ADVANCE /AMERICAN LINCOLN / CLARKE / KENT	56600282	SQUEEGEE CARTRIDGE (QBA) (24" CHANNEL, 2	86803220 / AD-21-C
NILFISK - ADVANCE /AMERICAN LINCOLN / CLARKE / KENT	56600366	BULK GASKET PER FT. (ROLL = 50')	86634100 / AG-1-B
NILFISK - ADVANCE /AMERICAN LINCOLN / CLARKE / KENT	56601094	BLADE KIT, RED	98486660
NILFISK - ADVANCE /AMERICAN LINCOLN / CLARKE / KENT	56601531	BLADE KIT, 28	98486670
NILFISK - ADVANCE /AMERICAN LINCOLN / CLARKE / KENT	56601532	BLADE KIT, TAN GUM 34"	98486680
NILFISK - ADVANCE /AMERICAN LINCOLN / CLARKE / KENT	56601532	BLADE KIT, TAN GUM 34"	98486680
NILFISK - ADVANCE /AMERICAN LINCOLN / CLARKE / KENT	56630122	WHEEL	86634410 / PB-5
NILFISK - ADVANCE /AMERICAN LINCOLN / CLARKE / KENT	56630267	HANDLE, UPPER ASSEMBLY W/GRIP	86853350 / VCP-49
NILFISK - ADVANCE /AMERICAN LINCOLN / CLARKE / KENT	56630268	HANDLE TUBE, LOWER	86853190 / VCP-34
NILFISK - ADVANCE /AMERICAN LINCOLN / CLARKE / KENT	56630358	MOTOR ASSY	86649300 / VCP-37
NILFISK - ADVANCE /AMERICAN LINCOLN / CLARKE / KENT	56630387	BLACK CLOTH BAG, TOP FILL	86720420 / FBE-84-B
NILFISK - ADVANCE /AMERICAN LINCOLN / CLARKE / KENT	56630395	PEDAL, FOOT	86853120 / VCP-28
NILFISK - ADVANCE /AMERICAN LINCOLN / CLARKE / KENT	56630451	BOTTOM PLATE ASSMBLY, 16"	86723910
NILFISK - ADVANCE /AMERICAN LINCOLN / CLARKE / KENT	56630487	CAP, DISTRIBUTOR END (METAL)	86853310 / VCP-45
NILFISK - ADVANCE /AMERICAN LINCOLN / CLARKE / KENT	56630493	DISTRIBUTOR ASSEMBLY 16"	86853090 / VCP-24
NILFISK - ADVANCE /AMERICAN LINCOLN / CLARKE / KENT	56630500	WHEEL, REAR	86853290 / VCP-43

Visit our website for the most current and complete OEM interchange



OEM	OEM Part #	Material Description	Graco Part # / Old Graco#
NILFISK - ADVANCE /AMERICAN LINCOLN / CLARKE / KENT	56630507	BUMPER, 16" (QBA)	86853360 / VCP-5
NILFISK - ADVANCE /AMERICAN LINCOLN / CLARKE / KENT	56630508	BUMPER, 12" (QBA)	86853250 / VCP-4
NILFISK - ADVANCE /AMERICAN LINCOLN / CLARKE / KENT	56630562	GASKET	86647890 / VCP-39
NILFISK - ADVANCE /AMERICAN LINCOLN / CLARKE / KENT	56630563	BELT (QBA)	86600880 / BLE-3
NILFISK - ADVANCE /AMERICAN LINCOLN / CLARKE / KENT	56630567	MOTOR BASE ASSEMBLY	86853230 / VCP-38
NILFISK - ADVANCE /AMERICAN LINCOLN / CLARKE / KENT	56630606	COVER, WHEEL	86853370 / VCP-50
NILFISK - ADVANCE /AMERICAN LINCOLN / CLARKE / KENT	56630621	SWITCH-PUSH	86641660 / VCP-2
NILFISK - ADVANCE /AMERICAN LINCOLN / CLARKE / KENT	56630665	PULLEY	86853260 / VCP-40
NILFISK - ADVANCE /AMERICAN LINCOLN / CLARKE / KENT	56630668	ADAPTER RETAINER SPRING	86723960 / VCP-9
NILFISK - ADVANCE /AMERICAN LINCOLN / CLARKE / KENT	56630696	HANDLE SOCKET ASSEMBLY W/ SPRING	86853170 / VCP-32
NILFISK - ADVANCE /AMERICAN LINCOLN / CLARKE / KENT	56630765	SPRING	86723940 / VCP-33
NILFISK - ADVANCE /AMERICAN LINCOLN / CLARKE / KENT	56630767	PUSH NUT (EA)	86853270 / VCP-41
NILFISK - ADVANCE /AMERICAN LINCOLN / CLARKE / KENT	56630768	BUSHING, STRAIN RELIEF EACH	86853380 / VCP-51
NILFISK - ADVANCE /AMERICAN LINCOLN / CLARKE / KENT	56630799	WASHER, FAN (EA) (53148)	86853110 / VCP-27
NILFISK - ADVANCE /AMERICAN LINCOLN / CLARKE / KENT	56630919	SCREW W/NUT	86674170 / VCP-46
NILFISK - ADVANCE /AMERICAN LINCOLN / CLARKE / KENT	56635645	MOTOR .75 GEAR 36 VOLT	86838680 / F755400
NILFISK - ADVANCE /AMERICAN LINCOLN / CLARKE / KENT	56637610	CORD 75' 14/3 YELLOW ST 600V	86695500 / E-4752Y
NILFISK - ADVANCE /AMERICAN LINCOLN / CLARKE / KENT	56637876	24 VOLT 3 STAGE VAC MOTOR	86854550 / VM-23
NILFISK - ADVANCE /AMERICAN LINCOLN / CLARKE / KENT	56639470	PUMP,SHURFLO 12V.56035257	86634170 / M-106
NILFISK - ADVANCE /AMERICAN LINCOLN / CLARKE / KENT	56648423	BLACK CLOTH BAG, TOP FILL	86720420 / FBE-84-B
NILFISK - ADVANCE /AMERICAN LINCOLN / CLARKE / KENT	56649823	Wheel with Bracket 6.75" Overall Height	86637020
NILFISK - ADVANCE /AMERICAN LINCOLN / CLARKE / KENT	56703010	BELT-HOOVER (QBA)	86828920 / BLH-1
NILFISK - ADVANCE /AMERICAN LINCOLN / CLARKE / KENT	56703035	PAPER BAG (PK) HOOVER,A	86633170 / PBH-1
NILFISK - ADVANCE /AMERICAN LINCOLN / CLARKE / KENT	56703487	FAN, LEXAN	86711430 / FE-1
NILFISK - ADVANCE /AMERICAN LINCOLN / CLARKE / KENT	56703768	BAGS, FILTER (10 PACK) - 152B DURAVAC	86848200 / PBA-4
NILFISK - ADVANCE /AMERICAN LINCOLN / CLARKE / KENT	56703910	5 BAGS & 1 FILTER	86642360 / PBA-5
NILFISK - ADVANCE /AMERICAN LINCOLN / CLARKE / KENT	56704331	POWER CORD	86652930 / E-40Y
NILFISK - ADVANCE /AMERICAN LINCOLN / CLARKE / KENT	56741122	SPROCKET-DRIVE MOTOR 898550	86606570 / BLC-16
NILFISK - ADVANCE /AMERICAN LINCOLN / CLARKE / KENT	56761678	NOZZLE 1506	86652570 / PWA-60
NILFISK - ADVANCE /AMERICAN LINCOLN / CLARKE / KENT	140690502	BAGS, FILTER (10 PACK) - UZ934	86848460 / PBK-2
NILFISK - ADVANCE /AMERICAN LINCOLN / CLARKE / KENT	560202642	SQUEEGEE SET	98484750 / K-266-2
NILFISK - ADVANCE /AMERICAN LINCOLN / CLARKE / KENT	560556578	5" POLY SWIVEL CASTER(F) (QBA)	86606110 / WC-3
NILFISK - ADVANCE /AMERICAN LINCOLN / CLARKE / KENT	561000621	PLUG HOUSING 50A-RED	86634000 / CHP-7-R
NILFISK - ADVANCE /AMERICAN LINCOLN / CLARKE / KENT	1406905010	BAGS, FILTER (10 PACK) - UZ934	86848460 / PBK-2
NILFISK - ADVANCE /AMERICAN LINCOLN / CLARKE / KENT	1407015020	BAGS, FILTER (10 PACK) UZ930, MB39CV	86848440 / PBK-1
NILFISK - ADVANCE /AMERICAN LINCOLN / CLARKE / KENT	1407015040	BAGS, FILTER (10 PACK) UZ930, MB39CV	86848440 / PBK-1
NILFISK - ADVANCE /AMERICAN LINCOLN / CLARKE / KENT	1451899000	BROOM, SIDE POLY	88055700
NILFISK - ADVANCE /AMERICAN LINCOLN / CLARKE / KENT	1454879000	BROOM, MAIN STD	88055730
NILFISK - ADVANCE /AMERICAN LINCOLN / CLARKE / KENT	1454959000	BROOM, SIDE STEEL MIX	88055710
NILFISK - ADVANCE /AMERICAN LINCOLN / CLARKE / KENT	1454963000	BROOM, MAIN	88055800
NILFISK - ADVANCE /AMERICAN LINCOLN / CLARKE / KENT	1454976000	BROOM, SIDE NATURAL FIBER	88055720
NILFISK - ADVANCE /AMERICAN LINCOLN / CLARKE / KENT	1456080000	BROOM, MAIN NATURAL FIBRE	88055750
NILFISK - ADVANCE /AMERICAN LINCOLN / CLARKE / KENT	1456135000	BROOM, MAIN	88055790
NILFISK - ADVANCE /AMERICAN LINCOLN / CLARKE / KENT	1460678000	BROOM, SIDE NYLON STD.	88055690
NILFISK - ADVANCE /AMERICAN LINCOLN / CLARKE / KENT	1460748000	BROOM, MAIN POLY	88055660
NILFISK - ADVANCE /AMERICAN LINCOLN / CLARKE / KENT	1460749000	BROOM, MAIN NATURAL FIBER	88055680
NILFISK - ADVANCE /AMERICAN LINCOLN / CLARKE / KENT	1460750000	BROOM, MAIN STEEL MIX	88055670
NILFISK - ADVANCE /AMERICAN LINCOLN / CLARKE / KENT	1460751000	BROOM, MAIN POLY	88055640
NILFISK - ADVANCE /AMERICAN LINCOLN / CLARKE / KENT	1460752000	BROOM, MAIN NYLON STD.	88055620
NILFISK - ADVANCE /AMERICAN LINCOLN / CLARKE / KENT	1460753000	BROOM, MAIN NATURAL FIBER	88055630

Visit our website for the most current and complete OEM interchange



OEM	OEM Part #	Material Description	Graco Part # / Old Graco#
NILFISK - ADVANCE /AMERICAN LINCOLN / CLARKE / KENT	1460754000	BROOM, MAIN STEEL MIX	88055650
NILFISK - ADVANCE /AMERICAN LINCOLN / CLARKE / KENT	1461018000	BROOM, MAIN POLY	88055780
NILFISK - ADVANCE /AMERICAN LINCOLN / CLARKE / KENT	1461025000	BROOM, SIDE	88055810
NILFISK - ADVANCE /AMERICAN LINCOLN / CLARKE / KENT	1461148000	BROOM, SIDE	88055820
NILFISK - ADVANCE /AMERICAN LINCOLN / CLARKE / KENT	1461149000	BROOM, SIDE	88055830
NILFISK - ADVANCE /AMERICAN LINCOLN / CLARKE / KENT	1471058500	PAPER BAG10/PK 2 PREFILTER 1 EXH.FILTER	86889590
NILFISK - ADVANCE /AMERICAN LINCOLN / CLARKE / KENT	3037069000	VAC HOSE ASSY, SQUEEGEE	98486240
NILFISK - ADVANCE /AMERICAN LINCOLN / CLARKE / KENT	9095582000	(K) HOSE VAC 1.5" X 24" W/ CUFFS	98482180 / VHN-2
NILFISK - ADVANCE /AMERICAN LINCOLN / CLARKE / KENT	9095583000	VAC HOSE ASSY, SQUEEGEE	98486310
NILFISK - ADVANCE /AMERICAN LINCOLN / CLARKE / KENT	9095820000	Belt	86749330
NILFISK - ADVANCE /AMERICAN LINCOLN / CLARKE / KENT	9096483000	SQ. BLADE - FRONT -	86739860
NILFISK - ADVANCE /AMERICAN LINCOLN / CLARKE / KENT	9096484000	BLADE, REAR GUM	86860610
NILFISK - ADVANCE /AMERICAN LINCOLN / CLARKE / KENT	9096860000	SQUEEGEE BLADE KIT	98486750
NILFISK - ADVANCE /AMERICAN LINCOLN / CLARKE / KENT	9098062000	(k) VAC MOTOR (VM-29 w/ 1-1/2" TUBE) 458	98482060 / VM-29-B
NILFISK - ADVANCE /AMERICAN LINCOLN / CLARKE / KENT	9098762000	CHARGE PLUG 120A RED, W/ TERM. 2.5"x1.75	86781100
NILFISK - ADVANCE /AMERICAN LINCOLN / CLARKE / KENT	0765-256	BRUSH ASSY. BLACK NYLON 16"	88056160
NILFISK - ADVANCE /AMERICAN LINCOLN / CLARKE / KENT	0765-257	BRUSH ASSY. POLY 16" (AMERFIL)	88056170
NILFISK - ADVANCE /AMERICAN LINCOLN / CLARKE / KENT	0765-258	BRUSH ASSY. SUPER GRIT 16"	88056180
NILFISK - ADVANCE /AMERICAN LINCOLN / CLARKE / KENT	0765-265	BRUSH ASSY. CLEANGRIT 16"	88056190
NILFISK - ADVANCE /AMERICAN LINCOLN / CLARKE / KENT	0765-271	BRUSH ASSY. BLACK NYLON	88056110
NILFISK - ADVANCE /AMERICAN LINCOLN / CLARKE / KENT	0765-272	BRUSH ASSY-POLYPROPYLENE	88056120
NILFISK - ADVANCE /AMERICAN LINCOLN / CLARKE / KENT	0765-273	BRUSH ASSY-SUPERGRIT	88056130
NILFISK - ADVANCE /AMERICAN LINCOLN / CLARKE / KENT	0765-274	BRUSH ASSY-CLEANGRIT	88056140
NILFISK - ADVANCE /AMERICAN LINCOLN / CLARKE / KENT	0775-119	CHARGER 24V, 25A	86632050 / CH-8
NILFISK - ADVANCE /AMERICAN LINCOLN / CLARKE / KENT	0775-145	24V CHARGER SEMI-AUTOMATIC (20A)	86832110 / CH-4250G
NILFISK - ADVANCE /AMERICAN LINCOLN / CLARKE / KENT	0775-155-1	CHARGER 36V 25A AUTO (50A GRAY)	86738020 / CH-3850G
NILFISK - ADVANCE /AMERICAN LINCOLN / CLARKE / KENT	0775-213	CHARGER 36V 25A AUTO (50A GRAY)	86738020 / CH-3850G
NILFISK - ADVANCE /AMERICAN LINCOLN / CLARKE / KENT	0780-434	PAD DRIVER ASSY.16"	88056200
NILFISK - ADVANCE /AMERICAN LINCOLN / CLARKE / KENT	0780-497	PAD DRIVER ASSY. 20"	88056150
NILFISK - ADVANCE /AMERICAN LINCOLN / CLARKE / KENT	0782-117	36V 3-STAGE VAC MOTOR (QBA) (119431-13)	86601200 / VM-24
NILFISK - ADVANCE /AMERICAN LINCOLN / CLARKE / KENT	0782-1243	36 VOLT 3 STAGE VAC MOTOR	86854650 / VM-280
NILFISK - ADVANCE /AMERICAN LINCOLN / CLARKE / KENT	0875-124	24V CHARGER SEMI-AUTOMATIC (20A)	86832110 / CH-4250G
NILFISK - ADVANCE /AMERICAN LINCOLN / CLARKE / KENT	0880-439	BROOM,SIDE WIRE (W/HARDWARE)	88056050
NILFISK - ADVANCE /AMERICAN LINCOLN / CLARKE / KENT	09012A	FLOAT SCREEN CAGE ASSY	86199840 / FNB-1
NILFISK - ADVANCE /AMERICAN LINCOLN / CLARKE / KENT	11060B	GASKET, CRANK CASE KAWASAKI FH500V-AS03	86847120 / PB-63
NILFISK - ADVANCE /AMERICAN LINCOLN / CLARKE / KENT	11062A	ISOLATOR KIT 12 MOUNTS	98484350
NILFISK - ADVANCE /AMERICAN LINCOLN / CLARKE / KENT	11063A	ISOLATOR KIT 12 MOUNTS	98484350
NILFISK - ADVANCE /AMERICAN LINCOLN / CLARKE / KENT	11063B	ISOLATOR KIT 12 MOUNTS	98484350
NILFISK - ADVANCE /AMERICAN LINCOLN / CLARKE / KENT	11173A	ISOLATOR KIT 8 MOUNTS	98484360
NILFISK - ADVANCE /AMERICAN LINCOLN / CLARKE / KENT	11334A	SQUEEGEE SET GUM 41" SQ. TOOL	98486410
NILFISK - ADVANCE /AMERICAN LINCOLN / CLARKE / KENT	11335A	SQUEEGEE SET GUM 35" SQ. TOOL	98486430
NILFISK - ADVANCE /AMERICAN LINCOLN / CLARKE / KENT	11337A	SQUEEGEE SET RED 41" SQ. TOOL	98486400
NILFISK - ADVANCE /AMERICAN LINCOLN / CLARKE / KENT	11338A	SQUEEGEE SET RED 35" SQ. TOOL	98486420
NILFISK - ADVANCE /AMERICAN LINCOLN / CLARKE / KENT	11424A	SCRUB BR LIGHT W/ADAPTER	86830020 / BRL-32-LD
NILFISK - ADVANCE /AMERICAN LINCOLN / CLARKE / KENT	11424B	SCRUB BR LIGHT W/ADAPTER	86830020 / BRL-32-LD
NILFISK - ADVANCE /AMERICAN LINCOLN / CLARKE / KENT	11426B	GRIT BRUSH-26	86605170 / BRL-26-HD
NILFISK - ADVANCE /AMERICAN LINCOLN / CLARKE / KENT	11502A	PAD HOLDER	86633830 / PH-3
NILFISK - ADVANCE /AMERICAN LINCOLN / CLARKE / KENT	14092A	SWITCH-FLOAT,47364B	86605740 / EC-92
NILFISK - ADVANCE /AMERICAN LINCOLN / CLARKE / KENT	15808A	(k) CAM ASSY-FM (ASSEMBLED)	98480510 / FM-7
NILFISK - ADVANCE /AMERICAN LINCOLN / CLARKE / KENT	16052A	SHURFLO 8000 (60 PSI)	86601060 / M-103

Visit our website for the most current and complete OEM interchange



OEM	OEM Part #	Material Description	Graco Part # / Old Graco#
NILFISK - ADVANCE /AMERICAN LINCOLN / CLARKE / KENT	17521C	PAD DRIVER W/ ADAPTER,26	86605550 / BRL-26-AG
NILFISK - ADVANCE /AMERICAN LINCOLN / CLARKE / KENT	18106A	(k) CHAIN	98480000 / BLA-83
NILFISK - ADVANCE /AMERICAN LINCOLN / CLARKE / KENT	19601A	(k) COMPLETE-DRIVE WHEEL & AXLE	98481280 / WC-5-A
NILFISK - ADVANCE /AMERICAN LINCOLN / CLARKE / KENT	19601B	(k) COMPLETE-DRIVE WHEEL & AXLE	98481280 / WC-5-A
NILFISK - ADVANCE /AMERICAN LINCOLN / CLARKE / KENT	19601C	(k) COMPLETE-DRIVE WHEEL & AXLE	98481280 / WC-5-A
NILFISK - ADVANCE /AMERICAN LINCOLN / CLARKE / KENT	19603A	(k) COMPLETE-DRIVE WHEEL & AXLE	98481280 / WC-5-A
NILFISK - ADVANCE /AMERICAN LINCOLN / CLARKE / KENT	2-00-01005	SWITCH, TOGGLE	86606630 / EA-3
NILFISK - ADVANCE /AMERICAN LINCOLN / CLARKE / KENT	2-00-01046	BELT	86618340 / BLA-28
NILFISK - ADVANCE /AMERICAN LINCOLN / CLARKE / KENT	2-00-01062	BELT	86828300 / BLAL-15
NILFISK - ADVANCE /AMERICAN LINCOLN / CLARKE / KENT	2-00-01063	BELT	86711460 / BLAL-16
NILFISK - ADVANCE /AMERICAN LINCOLN / CLARKE / KENT	2-00-01139	BALL BEARING	86626360 / CB-11
NILFISK - ADVANCE /AMERICAN LINCOLN / CLARKE / KENT	2-00-01158	BEARING	86831690 / CB-10
NILFISK - ADVANCE /AMERICAN LINCOLN / CLARKE / KENT	2-00-01176	BEARING	86626340 / MC-23
NILFISK - ADVANCE /AMERICAN LINCOLN / CLARKE / KENT	2-00-01215	BEARING, BALL (6205-2RS)	86626370 / MC-1-B
NILFISK - ADVANCE /AMERICAN LINCOLN / CLARKE / KENT	2-00-03423	S.B. PLUG 50A grey 911185	86634080 / CHP-2
NILFISK - ADVANCE /AMERICAN LINCOLN / CLARKE / KENT	2-00-03499	SWITCH BRUSH	86606590 / EA-8
NILFISK - ADVANCE /AMERICAN LINCOLN / CLARKE / KENT	2-00-03536	V BELT	86828330 / BLAL-2
NILFISK - ADVANCE /AMERICAN LINCOLN / CLARKE / KENT	2-00-04071	SOLENOID 36V.56395452,	86606490 / EC-43
NILFISK - ADVANCE /AMERICAN LINCOLN / CLARKE / KENT	2-00-04073	BELT- 21-RPM	86828340 / BLAL-24
NILFISK - ADVANCE /AMERICAN LINCOLN / CLARKE / KENT	2-00-04439	SWITCH - LIFT & LOWER MPW-40	86617090 / EA-21
NILFISK - ADVANCE /AMERICAN LINCOLN / CLARKE / KENT	2-00-04825	SOLENOID 36V.56395452,	86606490 / EC-43
NILFISK - ADVANCE /AMERICAN LINCOLN / CLARKE / KENT	2-22-00013	FLOAT GASKET	86805860 / AL-G-3
NILFISK - ADVANCE /AMERICAN LINCOLN / CLARKE / KENT	2-22-01895	GASKET (1/4X7/8X51" W/ A)	86805880 / AL-G-6
NILFISK - ADVANCE /AMERICAN LINCOLN / CLARKE / KENT	2-22-02139	24V VAC MOTOR (QBA) (116155-00)	86601190 / VM-1
NILFISK - ADVANCE /AMERICAN LINCOLN / CLARKE / KENT	25201A	KNOB, 3/8-16 4 PRONG ALUM	86009200 / SC-10
NILFISK - ADVANCE /AMERICAN LINCOLN / CLARKE / KENT	25201B	KNOB, 3/8-16 4 PRONG ALUM	86009200 / SC-10
NILFISK - ADVANCE /AMERICAN LINCOLN / CLARKE / KENT	2-95-.3087	BEARING FOR WA-1	86855340 / WA-1-B
NILFISK - ADVANCE /AMERICAN LINCOLN / CLARKE / KENT	2-95-02248	SWITCH,KEY 56441538	86612660 / EAL-1
NILFISK - ADVANCE /AMERICAN LINCOLN / CLARKE / KENT	30049B	BUMPER WHEEL 2 x 7/8"	86602150 / WTN-6
NILFISK - ADVANCE /AMERICAN LINCOLN / CLARKE / KENT	30065A	(k)LID GASKET 14D010	98482280 / C-G-67
NILFISK - ADVANCE /AMERICAN LINCOLN / CLARKE / KENT	30065B	(k)LID GASKET 14D010	98482280 / C-G-67
NILFISK - ADVANCE /AMERICAN LINCOLN / CLARKE / KENT	30066A	32" Front Ribbed Blade (QBA) HARD SERRAT	86831070 / C-242632-2B
NILFISK - ADVANCE /AMERICAN LINCOLN / CLARKE / KENT	30067A	32" Gum Rear Blade (QBA)	86831060 / C-242632-2A
NILFISK - ADVANCE /AMERICAN LINCOLN / CLARKE / KENT	30067L	BLADE, OUTER- RED 35.12"	86872280
NILFISK - ADVANCE /AMERICAN LINCOLN / CLARKE / KENT	30069A	39" Gum Rubber (QBA) Rear Blade	86831090 / C-242639-2A
NILFISK - ADVANCE /AMERICAN LINCOLN / CLARKE / KENT	30091A	BLADE SQ	86671550 / C-242639-2B
NILFISK - ADVANCE /AMERICAN LINCOLN / CLARKE / KENT	30181A	4X1 WHEEL	86855670 / WC-23
NILFISK - ADVANCE /AMERICAN LINCOLN / CLARKE / KENT	30405A	HOSE,DRAIN 30405A - VHC87	86605520 / VHC-87
NILFISK - ADVANCE /AMERICAN LINCOLN / CLARKE / KENT	30409B	(k) HOSE,SQUEEGEE	98480860 / VHC-83
NILFISK - ADVANCE /AMERICAN LINCOLN / CLARKE / KENT	30412A	HOSE, SOLUTION	86638530 / VHC-88
NILFISK - ADVANCE /AMERICAN LINCOLN / CLARKE / KENT	30557L	REAR BLADE,(QBA)28/33 FOR 10803KL	86831250 / C-2833F-2A
NILFISK - ADVANCE /AMERICAN LINCOLN / CLARKE / KENT	30624A	BLADE, TAN GUM (QBA) 30-1/2" Lo	86606750 / C-60-3A
NILFISK - ADVANCE /AMERICAN LINCOLN / CLARKE / KENT	30717L1	FRONT BLADE,(QBA)28/33 FOR 10803K	86831260 / C-2833F-2B
NILFISK - ADVANCE /AMERICAN LINCOLN / CLARKE / KENT	30717L2	SQ BLADE	86671910 / C-33F-2A
NILFISK - ADVANCE /AMERICAN LINCOLN / CLARKE / KENT	30718L2	INNER BLADE, 38 FOCUS	86831480 / C-38F-2B
NILFISK - ADVANCE /AMERICAN LINCOLN / CLARKE / KENT	30764L1	BLADE, INNER, NOTCHED 1/8" RED	86872290 / C-2829F-2B
NILFISK - ADVANCE /AMERICAN LINCOLN / CLARKE / KENT	30814U	SQ. BLADE, REAR URETHANE 41" TOOL	88055490
NILFISK - ADVANCE /AMERICAN LINCOLN / CLARKE / KENT	30815U	SQ. BLADE, REAR URETHANE 35" TOOL	88055510
NILFISK - ADVANCE /AMERICAN LINCOLN / CLARKE / KENT	30818U	SQ. BLADE, FRONT URETHANE 35" TOOL	88055520
NILFISK - ADVANCE /AMERICAN LINCOLN / CLARKE / KENT	30819U	SQ. BLADE, FRONT URETHANE 41" TOOL	88055500

Visit our website for the most current and complete OEM interchange



OEM	OEM Part #	Material Description	Graco Part # / Old Graco#
NILFISK - ADVANCE /AMERICAN LINCOLN / CLARKE / KENT	30902A	BLADE, TAN GUM (QBA) 2-3/8"x1/8"x29" -9	86608200 / C-2000-2A
NILFISK - ADVANCE /AMERICAN LINCOLN / CLARKE / KENT	30903A	BLADE, TAN GUM (QBA) 2-5/16"x1/8"x29" -9	86608210 / C-2000-2B
NILFISK - ADVANCE /AMERICAN LINCOLN / CLARKE / KENT	30912A	BLADE, TAN GUM (QBA) 2"x3/16"x38-1/2" -N	86605430 / C-26V-2A
NILFISK - ADVANCE /AMERICAN LINCOLN / CLARKE / KENT	30912L	REAR BLADE, (QBA) , 28 FOCUS	86831280 / C-28F-2A
NILFISK - ADVANCE /AMERICAN LINCOLN / CLARKE / KENT	30913A	BLADE, TAN GUM (QBA) 2"x3/16"x41-5/16" -	86605450 / C-32V-2A
NILFISK - ADVANCE /AMERICAN LINCOLN / CLARKE / KENT	30913L	SQUEEGEE BLADE	86671930 / C-33F-2B
NILFISK - ADVANCE /AMERICAN LINCOLN / CLARKE / KENT	30914A	BLADE, NEO (QBA) 1-7/8"x1/8"x35-7/8"-8 No	86605440 / C-26V-2B
NILFISK - ADVANCE /AMERICAN LINCOLN / CLARKE / KENT	30915A	BLADE, NEO (QBA) 1-7/8"x1/8"x39-3/4"-12	86605460 / C-32V-2B
NILFISK - ADVANCE /AMERICAN LINCOLN / CLARKE / KENT	30922A	BLADE, TAN GUM (QBA) 30-3/4" Long - 9 Ho	86606070 / C-24-3A
NILFISK - ADVANCE /AMERICAN LINCOLN / CLARKE / KENT	30923A	BLADE, TAN GUM (QBA) 2-1/2"x1/4"x37"- 17	86606780 / C-80-3A
NILFISK - ADVANCE /AMERICAN LINCOLN / CLARKE / KENT	30930A	BLADE, NEO (QBA) 1-15/16"x1/8"x25-7/8" -	86831000 / C-21V-2B
NILFISK - ADVANCE /AMERICAN LINCOLN / CLARKE / KENT	30931A	BLADE, TAN GUM (QBA) 2"x3/16"x28" Strip	86830990 / C-21V-2A
NILFISK - ADVANCE /AMERICAN LINCOLN / CLARKE / KENT	30931L	REAR BLADE, (QBA) 28/29" FOCUS	86831220 / C-2829F-2A
NILFISK - ADVANCE /AMERICAN LINCOLN / CLARKE / KENT	30934A	BLADE, NEO (QBA) 1-7/8"x1/8"x45-1/2" -No	86605840 / C-38V-2B
NILFISK - ADVANCE /AMERICAN LINCOLN / CLARKE / KENT	30935A	BLADE, GUM (QBA) 2-1/8"x3/16"x48" - No H	86605850 / C-38V-2A
NILFISK - ADVANCE /AMERICAN LINCOLN / CLARKE / KENT	30935L	OUTER BLADE, 38 FOCUS	86831470 / C-38F-2A
NILFISK - ADVANCE /AMERICAN LINCOLN / CLARKE / KENT	30946A	BLADE, TAN GUM (QBA) 2"x3/16"x32-1/2"	86605810 / C-20EL-2A
NILFISK - ADVANCE /AMERICAN LINCOLN / CLARKE / KENT	30947A	BLADE, NEO (QBA) 1-7/8"x1/8"x35-7/8"-8 No	86605440 / C-26V-2B
NILFISK - ADVANCE /AMERICAN LINCOLN / CLARKE / KENT	30950A	BLADE, RIDGED URETHANE (QBA) 2"x1/8"x30"	86605830 / C-20EL-2B
NILFISK - ADVANCE /AMERICAN LINCOLN / CLARKE / KENT	30951A	BLADE, RIDGED URETHANE (QBA) 2"x1/8"x26"	86830890 / C-20E-2B
NILFISK - ADVANCE /AMERICAN LINCOLN / CLARKE / KENT	33519B	STARTER	86633430 / PB-3
NILFISK - ADVANCE /AMERICAN LINCOLN / CLARKE / KENT	34220B	GASKET-VAC.CHAMBER 34220B	86607100 / C-G-80
NILFISK - ADVANCE /AMERICAN LINCOLN / CLARKE / KENT	34260B	GASKET-SQ.34260B (C-G-64)	86605500 / C-G-64
NILFISK - ADVANCE /AMERICAN LINCOLN / CLARKE / KENT	34265A	(k)RECOVERY LID GASKET (QBA) 14D008	98480190 / C-G-65
NILFISK - ADVANCE /AMERICAN LINCOLN / CLARKE / KENT	34265B	(k)RECOVERY LID GASKET (QBA) 14D008	98480190 / C-G-65
NILFISK - ADVANCE /AMERICAN LINCOLN / CLARKE / KENT	34266A	(k) SOLUTION LID GASKET (QBA) 14D009	98482190 / C-G-66
NILFISK - ADVANCE /AMERICAN LINCOLN / CLARKE / KENT	34400A	(k)GIMBAL, MOTOR	98480690 / SC-84
NILFISK - ADVANCE /AMERICAN LINCOLN / CLARKE / KENT	34400B	(k)GIMBAL, MOTOR	98480690 / SC-84
NILFISK - ADVANCE /AMERICAN LINCOLN / CLARKE / KENT	34402A	(k)GIMBAL, MOTOR	98480690 / SC-84
NILFISK - ADVANCE /AMERICAN LINCOLN / CLARKE / KENT	35133A	(K)HOSE, WIRE REINFORCED DRAIN 1.5" - 1.	98480850 / VHC-76
NILFISK - ADVANCE /AMERICAN LINCOLN / CLARKE / KENT	35192A	(k) RECOVERY HOSE	98481170 / VHC-84
NILFISK - ADVANCE /AMERICAN LINCOLN / CLARKE / KENT	38222A	SKIRT-L.H.38222A	86605700 / C-26V-SL
NILFISK - ADVANCE /AMERICAN LINCOLN / CLARKE / KENT	38223A	SKIRT-R.H.38223A	86605710 / C-26V-SR
NILFISK - ADVANCE /AMERICAN LINCOLN / CLARKE / KENT	38224A	SKIRT-R.H.38224A	86605730 / C-32V-SR
NILFISK - ADVANCE /AMERICAN LINCOLN / CLARKE / KENT	38225A	SKIRT-L.H.38225A	86605720 / C-32V-SL
NILFISK - ADVANCE /AMERICAN LINCOLN / CLARKE / KENT	38235A	SKIRT,R.H.V21,38235A	86605650 / C-21V-SR
NILFISK - ADVANCE /AMERICAN LINCOLN / CLARKE / KENT	38236A	SKIRT,L.H.V21,38236A	86605660 / C-21V-SL
NILFISK - ADVANCE /AMERICAN LINCOLN / CLARKE / KENT	40002A	SWITCH-FLOAT,47364B	86605740 / EC-92
NILFISK - ADVANCE /AMERICAN LINCOLN / CLARKE / KENT	40168B	SWITCH, MOMENTARY ROCKER	86834130 / EC-18
NILFISK - ADVANCE /AMERICAN LINCOLN / CLARKE / KENT	40169A	SOLENOID, VACUUM	86890460
NILFISK - ADVANCE /AMERICAN LINCOLN / CLARKE / KENT	40191A	VAC MOTOR	86603040 / WV-19
NILFISK - ADVANCE /AMERICAN LINCOLN / CLARKE / KENT	40200A	AMMETER (2000S)	86637310 / CHP-10
NILFISK - ADVANCE /AMERICAN LINCOLN / CLARKE / KENT	40203A	METER - BRUSH PRESSURE	86607430 / ECM-3
NILFISK - ADVANCE /AMERICAN LINCOLN / CLARKE / KENT	40500A	CHARGER 36V 25A AUTO (50A GRAY)	86738020 / CH-3850G
NILFISK - ADVANCE /AMERICAN LINCOLN / CLARKE / KENT	40506A	CHARGER 36V 25A AUTO (50A GRAY)	86738020 / CH-3850G
NILFISK - ADVANCE /AMERICAN LINCOLN / CLARKE / KENT	40510A	CHARGER 24V 12A AUTO (50A RED)	86600920 / CH-10
NILFISK - ADVANCE /AMERICAN LINCOLN / CLARKE / KENT	40512A	CHARGER 24V, 25A	86632050 / CH-8
NILFISK - ADVANCE /AMERICAN LINCOLN / CLARKE / KENT	40512B	CHARGER 24V. 25A.40512A	86632150 / CH-32
NILFISK - ADVANCE /AMERICAN LINCOLN / CLARKE / KENT	40671A	PUMP, 110/120 60HZ FLOJET	86201110 / M-108
NILFISK - ADVANCE /AMERICAN LINCOLN / CLARKE / KENT	40724A	24 VOLT 3 STAGE VAC MOTOR	86854780 / VM-34

Visit our website for the most current and complete OEM interchange



OEM	OEM Part #	Material Description	Graco Part # / Old Graco#
NILFISK - ADVANCE /AMERICAN LINCOLN / CLARKE / KENT	40749A	SWITCH, MOMENTARY ROCKER	86834120 / EC-17
NILFISK - ADVANCE /AMERICAN LINCOLN / CLARKE / KENT	40786A	SWITCH, KEY	86834190 / EC-23
NILFISK - ADVANCE /AMERICAN LINCOLN / CLARKE / KENT	40807A	CARBON BRUSH 833474	86623310 / F732775-1
NILFISK - ADVANCE /AMERICAN LINCOLN / CLARKE / KENT	40830A	BRUSH & BRUSH HOLDER (GREEN HOLDER) AMET	86801440
NILFISK - ADVANCE /AMERICAN LINCOLN / CLARKE / KENT	41102A	TIMER	86800110
NILFISK - ADVANCE /AMERICAN LINCOLN / CLARKE / KENT	41122A	(k) CABLE ASSY-CONSOLE	98480370 / CHP-4-A
NILFISK - ADVANCE /AMERICAN LINCOLN / CLARKE / KENT	41140A	(k) CONSOLE CABLE ASSY.	98481130 / CHP-26-A
NILFISK - ADVANCE /AMERICAN LINCOLN / CLARKE / KENT	41146A	(k) CONSOLE CABLE ASSY.	98481470 / CHP-25-A
NILFISK - ADVANCE /AMERICAN LINCOLN / CLARKE / KENT	41201A	(k) CABLE ASSY-BATTERY	98483170 / CHP-5-A
NILFISK - ADVANCE /AMERICAN LINCOLN / CLARKE / KENT	41206A	(k) BATTERY CABLE, SERIES	98481160 / CHP-29-A
NILFISK - ADVANCE /AMERICAN LINCOLN / CLARKE / KENT	41208A	(k) BATTERY CABLE ASSY.	98481150 / CHP-28-A
NILFISK - ADVANCE /AMERICAN LINCOLN / CLARKE / KENT	41211A	(k) BATTERY CABLE ASSY.	98481490 / CHP-27-A
NILFISK - ADVANCE /AMERICAN LINCOLN / CLARKE / KENT	41401B	CIRCUIT BREAKER 50 AMP (QBA)	86608520 / EA-50
NILFISK - ADVANCE /AMERICAN LINCOLN / CLARKE / KENT	41402B	CIRCUIT BREAKER-70 AMP	86608530 / EA-70
NILFISK - ADVANCE /AMERICAN LINCOLN / CLARKE / KENT	41409A	10 AMP BREAKER	86608930 / EA-72
NILFISK - ADVANCE /AMERICAN LINCOLN / CLARKE / KENT	41410A	CIRCUIT BREAKER 18 AMP	86608280 / EA-18
NILFISK - ADVANCE /AMERICAN LINCOLN / CLARKE / KENT	41412A	CIRCUIT BREAKER-70 AMP	86608530 / EA-70
NILFISK - ADVANCE /AMERICAN LINCOLN / CLARKE / KENT	41416A	CIRCUIT BREAKER 45 AMP (QBA)	86609510 / EA-45
NILFISK - ADVANCE /AMERICAN LINCOLN / CLARKE / KENT	41419A	15A.CIRCUIT BRK.740130	86618740 / EA-34
NILFISK - ADVANCE /AMERICAN LINCOLN / CLARKE / KENT	41420A	CIRCUIT BREAKER 20 AMP (QBA)	86609750 / EA-33
NILFISK - ADVANCE /AMERICAN LINCOLN / CLARKE / KENT	41422A	CIRCUIT BREAKER 25A (QBA) *	86608290 / ETN-4
NILFISK - ADVANCE /AMERICAN LINCOLN / CLARKE / KENT	41422B	CIRCUIT BREAKER, 25A	86834220 / EC-26
NILFISK - ADVANCE /AMERICAN LINCOLN / CLARKE / KENT	41423A	CIRCUIT BREAKER 5A	86608220 / EA-51
NILFISK - ADVANCE /AMERICAN LINCOLN / CLARKE / KENT	41423B	CIRCUIT BREAKER, 5A	86834230 / EC-27
NILFISK - ADVANCE /AMERICAN LINCOLN / CLARKE / KENT	41428A	CIRCUIT BREAKER 35AMP (QBA)	86608910 / EA-35
NILFISK - ADVANCE /AMERICAN LINCOLN / CLARKE / KENT	41430A	CIRCUIT BREAKER 1.5 (QBA)	86608270 / EA-16
NILFISK - ADVANCE /AMERICAN LINCOLN / CLARKE / KENT	41431A	CIRCUIT BREAKER 35AMP (QBA)	86608910 / EA-35
NILFISK - ADVANCE /AMERICAN LINCOLN / CLARKE / KENT	41431B	CIRCUIT BREAKER, 35A	86834240 / EC-28
NILFISK - ADVANCE /AMERICAN LINCOLN / CLARKE / KENT	41439A	CIRCUIT BREAKER 25A (QBA) *	86608290 / ETN-4
NILFISK - ADVANCE /AMERICAN LINCOLN / CLARKE / KENT	41444A	BREAKER, 30A 50VDC CIRCUIT - VAC MOTOR	86001910 / EA-29
NILFISK - ADVANCE /AMERICAN LINCOLN / CLARKE / KENT	41446A	BREAKER, 30A 50VDC CIRCUIT - VAC MOTOR	86001910 / EA-29
NILFISK - ADVANCE /AMERICAN LINCOLN / CLARKE / KENT	41448B	CIRCUIT BREAKER, 30A	86834250 / EC-29
NILFISK - ADVANCE /AMERICAN LINCOLN / CLARKE / KENT	41600A	CONNECTOR 60A, BLUE HOUSING W/TERMINAL	98486130 / E-82
NILFISK - ADVANCE /AMERICAN LINCOLN / CLARKE / KENT	41601A	TERMINAL, 6GA (CHARGER PLUG)	86634010 / E-84
NILFISK - ADVANCE /AMERICAN LINCOLN / CLARKE / KENT	41602A	CONNECTOR, BLUE HOUSING	86606880 / E-83
NILFISK - ADVANCE /AMERICAN LINCOLN / CLARKE / KENT	41801A	Relay 36VDC 100AMP HVY DUTY	86006370 / EA-80
NILFISK - ADVANCE /AMERICAN LINCOLN / CLARKE / KENT	41802A	SOLENOID 36v 41802A - etn16	86620760 / ETN-16
NILFISK - ADVANCE /AMERICAN LINCOLN / CLARKE / KENT	41804A	Relay 36VDC 100AMP HVY DUTY	86006370 / EA-80
NILFISK - ADVANCE /AMERICAN LINCOLN / CLARKE / KENT	41811A	SOLENOID MAIN	86648780 / EC-97
NILFISK - ADVANCE /AMERICAN LINCOLN / CLARKE / KENT	42022A	14/3 75' RED EXTENSION CORD	86633480 / E-4752R
NILFISK - ADVANCE /AMERICAN LINCOLN / CLARKE / KENT	42089A	CORD SET, 14/3 ST X 50' YLW	86234150 / E-452Y
NILFISK - ADVANCE /AMERICAN LINCOLN / CLARKE / KENT	42210A	BUFFER CORD 50' 14/3 RED	86617190 / E-452R
NILFISK - ADVANCE /AMERICAN LINCOLN / CLARKE / KENT	43401A	HOUSING,CONNECTOR-BLK	86833310 / E-86
NILFISK - ADVANCE /AMERICAN LINCOLN / CLARKE / KENT	43402A	HOUSING, CONNECTOR-BLUE	86833300 / E-85
NILFISK - ADVANCE /AMERICAN LINCOLN / CLARKE / KENT	44200A	LIGHT PILOT	86606330 / CPL-1
NILFISK - ADVANCE /AMERICAN LINCOLN / CLARKE / KENT	44809A	MOTOR/GEAR UNIT	86844120 / MTC-5
NILFISK - ADVANCE /AMERICAN LINCOLN / CLARKE / KENT	44809B	MOTOR/GEAR UNIT	86844120 / MTC-5
NILFISK - ADVANCE /AMERICAN LINCOLN / CLARKE / KENT	44900A	120 VOLT VAC MOTOR	86854990 / VM-6
NILFISK - ADVANCE /AMERICAN LINCOLN / CLARKE / KENT	44903A	120 VOLT VAC MOTOR	86855020 / VM-7
NILFISK - ADVANCE /AMERICAN LINCOLN / CLARKE / KENT	44904A	120 VOLT 2 STAGE VAC MOTOR	86854820 / VM-4

Visit our website for the most current and complete OEM interchange



OEM	OEM Part #	Material Description	Graco Part # / Old Graco#
NILFISK - ADVANCE /AMERICAN LINCOLN / CLARKE / KENT	44905A	SP. VAC MOTOR,220V.	86634840 / VM-21
NILFISK - ADVANCE /AMERICAN LINCOLN / CLARKE / KENT	44906A	120 VOLT 2 STAGE VAC MOTOR (VM-13)	86854420 / VM-13
NILFISK - ADVANCE /AMERICAN LINCOLN / CLARKE / KENT	44911A	VAC MOTOR	86854580 / VM-25
NILFISK - ADVANCE /AMERICAN LINCOLN / CLARKE / KENT	44917A	24 VOLT 3 STAGE VAC MOTOR	86854550 / VM-23
NILFISK - ADVANCE /AMERICAN LINCOLN / CLARKE / KENT	45007A	3¼ H.P. BRUSH MOTOR	86609140 / F732775
NILFISK - ADVANCE /AMERICAN LINCOLN / CLARKE / KENT	45019A	36 VOLT 3 STAGE VAC MOTOR	86854650 / VM-280
NILFISK - ADVANCE /AMERICAN LINCOLN / CLARKE / KENT	45033B	MOTOR .75 GEAR 36 VOLT	86838680 / F755400
NILFISK - ADVANCE /AMERICAN LINCOLN / CLARKE / KENT	45036A	MOTOR 1 HP W/GEARBOX,45036B	86609160 / F755401
NILFISK - ADVANCE /AMERICAN LINCOLN / CLARKE / KENT	45036B	MOTOR 1 HP W/GEARBOX,45036B	86609160 / F755401
NILFISK - ADVANCE /AMERICAN LINCOLN / CLARKE / KENT	45200A	(k)VAC MOTOR (VM-29w/1-7/8" TUBE)	98483190 / VM-29-A
NILFISK - ADVANCE /AMERICAN LINCOLN / CLARKE / KENT	45900A	SHURFLO 8000 (60 PSI)	86601060 / M-103
NILFISK - ADVANCE /AMERICAN LINCOLN / CLARKE / KENT	46106A	RECTIFIER	86889770
NILFISK - ADVANCE /AMERICAN LINCOLN / CLARKE / KENT	46507A	RAVERSE RESIS obso when stk is gone	86607810 / EC-46
NILFISK - ADVANCE /AMERICAN LINCOLN / CLARKE / KENT	46690A	VAC MOTOR	86623200 / VM-42
NILFISK - ADVANCE /AMERICAN LINCOLN / CLARKE / KENT	47303A	SWITCH 3 POS.	86607780 / EC-86
NILFISK - ADVANCE /AMERICAN LINCOLN / CLARKE / KENT	47317A	BRAKE SWITCH-MICRO, PUSH BUTTON MOMENTAR	86607760 / EC-80
NILFISK - ADVANCE /AMERICAN LINCOLN / CLARKE / KENT	47318A	SWITCH 47318A	86634570 / ETN-12
NILFISK - ADVANCE /AMERICAN LINCOLN / CLARKE / KENT	47320A	SWITCH BRUSH	86606590 / EA-8
NILFISK - ADVANCE /AMERICAN LINCOLN / CLARKE / KENT	47364A	SWITCH-FLOAT,47364B	86605740 / EC-92
NILFISK - ADVANCE /AMERICAN LINCOLN / CLARKE / KENT	47364C	SWITCH-FLOAT,47364B	86605740 / EC-92
NILFISK - ADVANCE /AMERICAN LINCOLN / CLARKE / KENT	47374A	SWITCH LIMIT	86616030 / EAL-5
NILFISK - ADVANCE /AMERICAN LINCOLN / CLARKE / KENT	47380A	SWITCH, KEY 47380A	86605860 / EC-90
NILFISK - ADVANCE /AMERICAN LINCOLN / CLARKE / KENT	47381B	SWITCH-BRUSH,47381A(1 1/2"L x 1"W)	86608080 / EA-36
NILFISK - ADVANCE /AMERICAN LINCOLN / CLARKE / KENT	47384A	SWITCH-TOGGLE,47384C, 827060	86605870 / EC-88
NILFISK - ADVANCE /AMERICAN LINCOLN / CLARKE / KENT	47384B	SWITCH-TOGGLE,47384C, 827060	86605870 / EC-88
NILFISK - ADVANCE /AMERICAN LINCOLN / CLARKE / KENT	47384C	SWITCH-TOGGLE,47384C, 827060	86605870 / EC-88
NILFISK - ADVANCE /AMERICAN LINCOLN / CLARKE / KENT	47389A	SWITCH,BRUSH-47389A	86605930 / EC-91
NILFISK - ADVANCE /AMERICAN LINCOLN / CLARKE / KENT	48703A	36V Solenoid Valve	86605980
NILFISK - ADVANCE /AMERICAN LINCOLN / CLARKE / KENT	50004A	SPARK PLUG	86637010 / PB-151
NILFISK - ADVANCE /AMERICAN LINCOLN / CLARKE / KENT	50005A	AIR FILTER KAWASAKI	86635210 / PB-123
NILFISK - ADVANCE /AMERICAN LINCOLN / CLARKE / KENT	50019A	STARTER 12V - kawasaki 17 hp.	86636390 / PB-156
NILFISK - ADVANCE /AMERICAN LINCOLN / CLARKE / KENT	50021A	ELEMENT AIR FILTER	86635410 / PB-122
NILFISK - ADVANCE /AMERICAN LINCOLN / CLARKE / KENT	50027a	OIL FILTER	86636100 / PB-139
NILFISK - ADVANCE /AMERICAN LINCOLN / CLARKE / KENT	50028A	BONNET FILTER, KAWA(CLARKE) 2.25"x12"	86859010 / PB-167
NILFISK - ADVANCE /AMERICAN LINCOLN / CLARKE / KENT	50125A	CONTACTOR, VAC	86834180 / EC-22
NILFISK - ADVANCE /AMERICAN LINCOLN / CLARKE / KENT	502404-7	COUPLING, FM SERIES	86637390 / BLC-30
NILFISK - ADVANCE /AMERICAN LINCOLN / CLARKE / KENT	502407-0	COUPLING, FM SERIES	86637390 / BLC-30
NILFISK - ADVANCE /AMERICAN LINCOLN / CLARKE / KENT	50299A	L.P. HOSE 16" (1/4"MPT FITTINGS)	86857080 / PB-166
NILFISK - ADVANCE /AMERICAN LINCOLN / CLARKE / KENT	50397A	WHEEL,6" A.L.COOKE	86637130 / WAC-1
NILFISK - ADVANCE /AMERICAN LINCOLN / CLARKE / KENT	50441A	PUSH NUT (EA)	86853270 / VCP-41
NILFISK - ADVANCE /AMERICAN LINCOLN / CLARKE / KENT	50610A	ASSY. BRACKET AND SHELL AMETEK	86801770
NILFISK - ADVANCE /AMERICAN LINCOLN / CLARKE / KENT	50700A	RED TOP FILL CLOTH BAG	86633510 / FBE-84
NILFISK - ADVANCE /AMERICAN LINCOLN / CLARKE / KENT	50704A	BAGS, FILTER (10 PACK) (QBA) - COMBIVAC,	86848320 / PBC-5140
NILFISK - ADVANCE /AMERICAN LINCOLN / CLARKE / KENT	50721A	BAGS, FILTER (10 PACK) (QBA) - COMBIVAC,	86848320 / PBC-5140
NILFISK - ADVANCE /AMERICAN LINCOLN / CLARKE / KENT	50721B	BAGS, FILTER (10 PACK) (QBA) - COMBIVAC,	86848320 / PBC-5140
NILFISK - ADVANCE /AMERICAN LINCOLN / CLARKE / KENT	508545-1	GUIDE	86637410 / FM-1
NILFISK - ADVANCE /AMERICAN LINCOLN / CLARKE / KENT	508641-8	SOLUTION TANK, BUFFER	86634800 / MC-3500
NILFISK - ADVANCE /AMERICAN LINCOLN / CLARKE / KENT	50968A	CASTER, DUAL WHEEL	86887490
NILFISK - ADVANCE /AMERICAN LINCOLN / CLARKE / KENT	51049A	VAC MOTOR,24V.3-STG	86854560 / VM23A+
NILFISK - ADVANCE /AMERICAN LINCOLN / CLARKE / KENT	51050A	Vacuum motor 24VDC 2ST TD	86005440 / VM-29A+

Visit our website for the most current and complete OEM interchange



OEM	OEM Part #	Material Description	Graco Part # / Old Graco#
NILFISK - ADVANCE /AMERICAN LINCOLN / CLARKE / KENT	51419A	BRUSH MECH. EA. (33326-1 REPL 33308)	86801380
NILFISK - ADVANCE /AMERICAN LINCOLN / CLARKE / KENT	51903A	CORD,18-3/50' BEIGE	86633290 / VCP-6
NILFISK - ADVANCE /AMERICAN LINCOLN / CLARKE / KENT	52104A	4"CASTER WHEEL W/STEM (QBA) (F)	86608480 / WC-4
NILFISK - ADVANCE /AMERICAN LINCOLN / CLARKE / KENT	52108A	4"CASTER WHEEL W/STEM (QBA) (F)	86608480 / WC-4
NILFISK - ADVANCE /AMERICAN LINCOLN / CLARKE / KENT	52201A	(k)CHAIN W/LINK	98484470 / BLC-61
NILFISK - ADVANCE /AMERICAN LINCOLN / CLARKE / KENT	52202A	(k)DRIVE CHAIN	98480130 / BLC-81
NILFISK - ADVANCE /AMERICAN LINCOLN / CLARKE / KENT	52207A	(k) CHAIN, #35	98481650 / BLC-82
NILFISK - ADVANCE /AMERICAN LINCOLN / CLARKE / KENT	52320A	PAPER BAG (3 PACK) (QBA)	86848300 / PBC-300
NILFISK - ADVANCE /AMERICAN LINCOLN / CLARKE / KENT	52899A	PUMP, 110/120 60HZ FLOJET	86201110 / M-108
NILFISK - ADVANCE /AMERICAN LINCOLN / CLARKE / KENT	53115A	AIR INLET DUCT, LEFT SIDE	86852960 / VCP-11
NILFISK - ADVANCE /AMERICAN LINCOLN / CLARKE / KENT	53116A	AIR INLET DUCT, RIGHT SIDE	86852970 / VCP-12
NILFISK - ADVANCE /AMERICAN LINCOLN / CLARKE / KENT	53118A	DISTRIBUTOR ASSEMBLY 16"	86853090 / VCP-24
NILFISK - ADVANCE /AMERICAN LINCOLN / CLARKE / KENT	53399A	5/8 FLANGE BEARING ASSY F	86608160 / CFB-1
NILFISK - ADVANCE /AMERICAN LINCOLN / CLARKE / KENT	53908A	STATIONARY FAN	86801140
NILFISK - ADVANCE /AMERICAN LINCOLN / CLARKE / KENT	53914A	ROTATING FAN	86800990
NILFISK - ADVANCE /AMERICAN LINCOLN / CLARKE / KENT	53996A	FAN	86801210
NILFISK - ADVANCE /AMERICAN LINCOLN / CLARKE / KENT	54025A	BAGS, FILTER (10 PACK) (QBA) - COMBIVAC,	86848320 / PBC-5140
NILFISK - ADVANCE /AMERICAN LINCOLN / CLARKE / KENT	54238A	GEAR BOX 54238A	86609030 / BLC-24
NILFISK - ADVANCE /AMERICAN LINCOLN / CLARKE / KENT	54240A	BUMPER, 12" (QBA)	86853250 / VCP-4
NILFISK - ADVANCE /AMERICAN LINCOLN / CLARKE / KENT	54445A	ISOLATOR KIT 8 MOUNTS	98484360
NILFISK - ADVANCE /AMERICAN LINCOLN / CLARKE / KENT	54500A	HANDLE GRIP(GREY)	86853160 / VCP-31
NILFISK - ADVANCE /AMERICAN LINCOLN / CLARKE / KENT	54900A	HANDLE, UPPER ASSEMBLY W/GRIP	86853350 / VCP-49
NILFISK - ADVANCE /AMERICAN LINCOLN / CLARKE / KENT	54918A	HANDLE TUBE, LOWER	86853190 / VCP-34
NILFISK - ADVANCE /AMERICAN LINCOLN / CLARKE / KENT	55525A	KNOB, 3/8-16 4 PRONG ALUM	86009200 / SC-10
NILFISK - ADVANCE /AMERICAN LINCOLN / CLARKE / KENT	55529A	KNOB	86644520 / VCP-10
NILFISK - ADVANCE /AMERICAN LINCOLN / CLARKE / KENT	56014A	VAC MOTOR	86603040 / WV-19
NILFISK - ADVANCE /AMERICAN LINCOLN / CLARKE / KENT	56026047-1	24 VOLT 3 STAGE VAC MOTOR	86854780 / VM-34
NILFISK - ADVANCE /AMERICAN LINCOLN / CLARKE / KENT	56040A	MOTOR ASSY	86649300 / VCP-37
NILFISK - ADVANCE /AMERICAN LINCOLN / CLARKE / KENT	56476A	VAC STRAINER,VISION 56476A	86605490 / FC-63
NILFISK - ADVANCE /AMERICAN LINCOLN / CLARKE / KENT	56497A	HANDLE SOCKET ASSEMBLY W/ SPRING	86853170 / VCP-32
NILFISK - ADVANCE /AMERICAN LINCOLN / CLARKE / KENT	56800A	PEDAL, FOOT	86853120 / VCP-28
NILFISK - ADVANCE /AMERICAN LINCOLN / CLARKE / KENT	56868A	BOTTOM PLATE ASSMBLY, 16"	86723910
NILFISK - ADVANCE /AMERICAN LINCOLN / CLARKE / KENT	56905A	PAD HOLDER-CLIP 56182058	86633840 / PH-3-P
NILFISK - ADVANCE /AMERICAN LINCOLN / CLARKE / KENT	56941A	Lock PAD CENTER SNAP,TWO STEP	86005070 / PH-8
NILFISK - ADVANCE /AMERICAN LINCOLN / CLARKE / KENT	57249A	PULLEY	86853260 / VCP-40
NILFISK - ADVANCE /AMERICAN LINCOLN / CLARKE / KENT	57300A	RETAINER	86641640 / VCP-2
NILFISK - ADVANCE /AMERICAN LINCOLN / CLARKE / KENT	57301A	HOOK,CORD LOWER SANITAIRE (QBA)	86853140 / VCP-3
NILFISK - ADVANCE /AMERICAN LINCOLN / CLARKE / KENT	57332A	PAD HOLDER-CLIP 56182058	86633840 / PH-3-P
NILFISK - ADVANCE /AMERICAN LINCOLN / CLARKE / KENT	57371A	(k) CORD RETAINER HOOK SET	98482050 / VCP-23
NILFISK - ADVANCE /AMERICAN LINCOLN / CLARKE / KENT	57902A	SCREW W/NUT	86674170 / VCP-46
NILFISK - ADVANCE /AMERICAN LINCOLN / CLARKE / KENT	58069A	VAC SCREEN 58069A	86605390 / FC-64
NILFISK - ADVANCE /AMERICAN LINCOLN / CLARKE / KENT	58662A	SPRING	86723940 / VCP-33
NILFISK - ADVANCE /AMERICAN LINCOLN / CLARKE / KENT	59721A	DRAIN VALVE	86634390 / VC-72
NILFISK - ADVANCE /AMERICAN LINCOLN / CLARKE / KENT	59731A	DRAIN VALVE	86634390 / VC-72
NILFISK - ADVANCE /AMERICAN LINCOLN / CLARKE / KENT	59900A	WHEEL, FRONT	86853150 / VCP-30
NILFISK - ADVANCE /AMERICAN LINCOLN / CLARKE / KENT	59941A	WHEEL, REAR	86853290 / VCP-43
NILFISK - ADVANCE /AMERICAN LINCOLN / CLARKE / KENT	59944R	(k) DRIVE WHEEL (BLACK NON MARKING TIRE)	98483220 / WC-5-V
NILFISK - ADVANCE /AMERICAN LINCOLN / CLARKE / KENT	59950A	WHEEL,GUIDE 59950A	86605990 / WC-6
NILFISK - ADVANCE /AMERICAN LINCOLN / CLARKE / KENT	59955A	TIRE ASSY,GRAY HD FOAM,410/3.5-6 3.5BC	98486050 / WTN-7
NILFISK - ADVANCE /AMERICAN LINCOLN / CLARKE / KENT	59969A	TIRE & RIM ASSY	86642750 / WTN-8

Visit our website for the most current and complete OEM interchange



OEM	OEM Part #	Material Description	Graco Part # / Old Graco#
NILFISK - ADVANCE /AMERICAN LINCOLN / CLARKE / KENT	59971A	WHEEL,GUIDE 59950A	86605990 / WC-6
NILFISK - ADVANCE /AMERICAN LINCOLN / CLARKE / KENT	60154A	SHAFT, WHEEL, ROUND ENDS	86603310 / MC-29
NILFISK - ADVANCE /AMERICAN LINCOLN / CLARKE / KENT	603776-4	HOUSING AMETEK	86802190
NILFISK - ADVANCE /AMERICAN LINCOLN / CLARKE / KENT	61460A	WHEEL CASTER 56206725	86608720 / WA-3
NILFISK - ADVANCE /AMERICAN LINCOLN / CLARKE / KENT	61653A	CABLE,SQUEEGE LIFT	86605780 / SC-15
NILFISK - ADVANCE /AMERICAN LINCOLN / CLARKE / KENT	61912A	HANDLE-CAM	86637420 / FM-6
NILFISK - ADVANCE /AMERICAN LINCOLN / CLARKE / KENT	69195A	DRIVE COUPLER	86637400 / BLC-40
NILFISK - ADVANCE /AMERICAN LINCOLN / CLARKE / KENT	7-08-03170-1	DISC BRUSH ASSY. BLACK NYLON	88057050
NILFISK - ADVANCE /AMERICAN LINCOLN / CLARKE / KENT	7-08-03172-1	DISC BRUSH ASSY. POLY	88056880
NILFISK - ADVANCE /AMERICAN LINCOLN / CLARKE / KENT	7-08-03205-1	DISC BRUSH ASSY. SUPER GRIT	88056890
NILFISK - ADVANCE /AMERICAN LINCOLN / CLARKE / KENT	7-08-03262-1	DISC BRUSH ASSY. SOFT NYLON	88057070
NILFISK - ADVANCE /AMERICAN LINCOLN / CLARKE / KENT	7-08-03269	DISC BRUSH ASSY. CLEAN GRIT	88057060
NILFISK - ADVANCE /AMERICAN LINCOLN / CLARKE / KENT	7-08-03313	BROOM,MAIN FIBRE/WIRE	88056090
NILFISK - ADVANCE /AMERICAN LINCOLN / CLARKE / KENT	7-13-05061	(k) CHAIN	98480070 / BLAL-17
NILFISK - ADVANCE /AMERICAN LINCOLN / CLARKE / KENT	7-25-02030	Plug 1-3/4 DRAIN HOSE	86006340 / VAL-4
NILFISK - ADVANCE /AMERICAN LINCOLN / CLARKE / KENT	7-25-08016	SPLASHGUARD BLADE (QBA)	86805650 / AL-750-S
NILFISK - ADVANCE /AMERICAN LINCOLN / CLARKE / KENT	7-25-08044	BLADE, TAN GUM (QBA) 4-3/16"x3/8"x26" -	86805530 / AL-62-4C
NILFISK - ADVANCE /AMERICAN LINCOLN / CLARKE / KENT	7-25-08062	SKIRT INNER (QBA)	86831440 / C-34V-IE
NILFISK - ADVANCE /AMERICAN LINCOLN / CLARKE / KENT	7-29-00015	CLEANOUT DOOR GASKET	86805810 / AL-G-1
NILFISK - ADVANCE /AMERICAN LINCOLN / CLARKE / KENT	7-29-00016	CLEANOUT FLANGE GASKET	86805910 / AL-G-9
NILFISK - ADVANCE /AMERICAN LINCOLN / CLARKE / KENT	7-29-00042	FLOAT GASKET	86805860 / AL-G-3
NILFISK - ADVANCE /AMERICAN LINCOLN / CLARKE / KENT	7-29-00063	VACUUM MOTOR GASKET	86805870 / AL-G-4
NILFISK - ADVANCE /AMERICAN LINCOLN / CLARKE / KENT	7-29-00103	GASKET	86805820 / AL-G-10
NILFISK - ADVANCE /AMERICAN LINCOLN / CLARKE / KENT	7-29-00109	GASKET	86805830 / AL-G-11
NILFISK - ADVANCE /AMERICAN LINCOLN / CLARKE / KENT	7-29-00110	GASKET	86805840 / AL-G-12
NILFISK - ADVANCE /AMERICAN LINCOLN / CLARKE / KENT	7-29-00134	GASKET	86805820 / AL-G-10
NILFISK - ADVANCE /AMERICAN LINCOLN / CLARKE / KENT	7-29-00135	GASKET	86805830 / AL-G-11
NILFISK - ADVANCE /AMERICAN LINCOLN / CLARKE / KENT	7-29-00136	GASKET	86805840 / AL-G-12
NILFISK - ADVANCE /AMERICAN LINCOLN / CLARKE / KENT	7-33-02129	VACUUM HOSE	86853720 / VHAL-7
NILFISK - ADVANCE /AMERICAN LINCOLN / CLARKE / KENT	7-42-05015	#40 LINK OFFSET	86633940 / BLC-35
NILFISK - ADVANCE /AMERICAN LINCOLN / CLARKE / KENT	7-42-05016	40 LINK,CONN.	86633920 / BLAL-9
NILFISK - ADVANCE /AMERICAN LINCOLN / CLARKE / KENT	7-64-00020	CIRCUIT BREAKER 45 AMP (QBA)	86609510 / EA-45
NILFISK - ADVANCE /AMERICAN LINCOLN / CLARKE / KENT	7-77-00026	BLADE, BLACK (QBA) C.I. 2-1/2"x1/8"x25-1	86805300 / AL-21-2B
NILFISK - ADVANCE /AMERICAN LINCOLN / CLARKE / KENT	7-77-00027	BLADE, TAN GUM (QBA) 2-1/2"x1/4"x27" - 6	86805280 / AL-21-2A
NILFISK - ADVANCE /AMERICAN LINCOLN / CLARKE / KENT	7-77-00030	BLADE, C.I. NEO (QBA) 2-1/2"x1/8"x21-1/4	86805240 / AL-19-2A
NILFISK - ADVANCE /AMERICAN LINCOLN / CLARKE / KENT	7-77-00031	BLADE, C.I. NEO (QBA) 2-1/2"x1/8"x21-1/4	86805250 / AL-19-2B
NILFISK - ADVANCE /AMERICAN LINCOLN / CLARKE / KENT	7-77-00033	BLADE, NEO (QBA) 2-1/2x1/4x34 - 8 Holes	86805450 / AL-560-2AN
NILFISK - ADVANCE /AMERICAN LINCOLN / CLARKE / KENT	7-77-00035	BLADE, TAN GUM(QBA) 2-1/2"x1/4"x46-1/2"	86805680 / AL-772-2B
NILFISK - ADVANCE /AMERICAN LINCOLN / CLARKE / KENT	7-77-00036	BLADE, TAN GUM (QBA) 2-1/2"x1/4"x46-1/2"-	86805670 / AL-772-2A
NILFISK - ADVANCE /AMERICAN LINCOLN / CLARKE / KENT	7-77-00037	BLADE, TAN GUM (QBA) 2-1/2"x1/4"x30-1/2"	86805600 / AL-726-2A
NILFISK - ADVANCE /AMERICAN LINCOLN / CLARKE / KENT	7-77-00039	BLADE, C.I.(QBA) NEO 2-1/2x1/8x32-1/4 -	86805490 / AL-560-2SB
NILFISK - ADVANCE /AMERICAN LINCOLN / CLARKE / KENT	7-77-00043	BLADE, NEO (QBA) 2-1/2"x1/4"x30-1/2" - 8	86805610 / AL-726-2AN
NILFISK - ADVANCE /AMERICAN LINCOLN / CLARKE / KENT	7-77-00055	BLADE, NEO (QBA) 2-1/2"x1/8"x30-1/4" -8	86805800 / AL-950-C
NILFISK - ADVANCE /AMERICAN LINCOLN / CLARKE / KENT	7-77-00056	BLADE, BLACK (QBA) C.I. 2-1/2"x1/8"x26-1	86805640 / AL-750-2B
NILFISK - ADVANCE /AMERICAN LINCOLN / CLARKE / KENT	7-77-00057	BLADE, TAN GUM (QBA) 3-1/4x1/4x65 - Stri	86805550 / AL-70-5A
NILFISK - ADVANCE /AMERICAN LINCOLN / CLARKE / KENT	7-77-00060	BLADE, TAN GUM (QBA) 3-1/2x8x22 - 7 Hol	86805570 / AL-70-5C
NILFISK - ADVANCE /AMERICAN LINCOLN / CLARKE / KENT	7-77-00064	BLADE, TAN GUM (QBA) 2"x3/16"x38-1/2" -N	86805740 / AL-930-2A
NILFISK - ADVANCE /AMERICAN LINCOLN / CLARKE / KENT	7-77-00065	BLADE, NEOPRENE (QBA) 1-5/15"x1/8"x38-3/	86805750 / AL-930-2B
NILFISK - ADVANCE /AMERICAN LINCOLN / CLARKE / KENT	7-77-00069	BLADE, TAN GUM (QBA) 4"x3/8"x33" -8 Hole	86805720 / AL-77-8D
NILFISK - ADVANCE /AMERICAN LINCOLN / CLARKE / KENT	7-77-00070	BLADE, URETHANE (QBA) BACKUP 3-3/4"x1/8"	86805730 / AL-77-8E

Visit our website for the most current and complete OEM interchange



OEM	OEM Part #	Material Description	Graco Part # / Old Graco#
NILFISK - ADVANCE /AMERICAN LINCOLN / CLARKE / KENT	7-77-00076	BLADE, TAN GUM (QBA) 2-1/4X1/4X54-1/4 -	86805510 / AL-62-4A
NILFISK - ADVANCE /AMERICAN LINCOLN / CLARKE / KENT	7-77-00077	BLADE, URETHANE (QBA) 2-1/8x1/8x51-1/2-1	86805520 / AL-62-4B
NILFISK - ADVANCE /AMERICAN LINCOLN / CLARKE / KENT	7-77-00081	BLADE, TAN GUM (QBA) 2"x3/16"x38-1/2" -N	86805770 / AL-934-2A
NILFISK - ADVANCE /AMERICAN LINCOLN / CLARKE / KENT	7-77-00082	SQUEEGEE BLADE	86686320 / AL-934-2B
NILFISK - ADVANCE /AMERICAN LINCOLN / CLARKE / KENT	7-77-00107	BLADE,NEO 1/8"x3-1/16"x81-1/4" 48 SLT	88059960
NILFISK - ADVANCE /AMERICAN LINCOLN / CLARKE / KENT	7-82-00008	SWITCH LIMIT	86616030 / EAL-5
NILFISK - ADVANCE /AMERICAN LINCOLN / CLARKE / KENT	7-89-08023	BUMPER WHEEL	86618540 / WA-10
NILFISK - ADVANCE /AMERICAN LINCOLN / CLARKE / KENT	7-89-08033	CASTER ASSY	86692970 / WAL-7
NILFISK - ADVANCE /AMERICAN LINCOLN / CLARKE / KENT	7-89-08039	BUMPER WHEEL (F) 2 1/2 x 3/4	86603320 / WA-7
NILFISK - ADVANCE /AMERICAN LINCOLN / CLARKE / KENT	7-89-08073	CASTER ASSY	86692970 / WAL-7
NILFISK - ADVANCE /AMERICAN LINCOLN / CLARKE / KENT	7-90-07095	BATTERY CABLE	86827830 / BCS610
NILFISK - ADVANCE /AMERICAN LINCOLN / CLARKE / KENT	7-90-07106	BATTERY CABLE-BCS618	86827850 / BCS618
NILFISK - ADVANCE /AMERICAN LINCOLN / CLARKE / KENT	8-08-03107	BROOM, SIDE POLY	88056600
NILFISK - ADVANCE /AMERICAN LINCOLN / CLARKE / KENT	8-08-03137	BROOM,MAIN PROEX,6 DOUBLE ROWS	88056060
NILFISK - ADVANCE /AMERICAN LINCOLN / CLARKE / KENT	8-08-03141	BROOM,MAIN PROEX/WIRE,6 DOUBLE ROWS	88056070
NILFISK - ADVANCE /AMERICAN LINCOLN / CLARKE / KENT	8-08-03142	BROOM,MAIN NYLON,6 DOUBLE ROWS	88056080
NILFISK - ADVANCE /AMERICAN LINCOLN / CLARKE / KENT	8-08-03177	BROOM, SIDE NYLON	88056610
NILFISK - ADVANCE /AMERICAN LINCOLN / CLARKE / KENT	8-08-03180	BROOM, MAIN PROEX/WIRE 8 DOUBLE ROWS	88056550
NILFISK - ADVANCE /AMERICAN LINCOLN / CLARKE / KENT	8-08-03190	BROOM, MAIN PROEX 8 DOUBLE ROWS	88056570
NILFISK - ADVANCE /AMERICAN LINCOLN / CLARKE / KENT	8-08-03193	BROOM, NYLON 8 DOUBLE ROWS	88056560
NILFISK - ADVANCE /AMERICAN LINCOLN / CLARKE / KENT	8-08-03198	BROOM, MAIN HIGH DENSITY FIBRE/WIRE	88056580
NILFISK - ADVANCE /AMERICAN LINCOLN / CLARKE / KENT	8-08-03200	BROOM, MAIN POLY 8 DOUBLE ROWS	88056590
NILFISK - ADVANCE /AMERICAN LINCOLN / CLARKE / KENT	8-08-03202	BROOM,MAIN PROEX-WIRE,8 DOUBLE ROWS	88055970
NILFISK - ADVANCE /AMERICAN LINCOLN / CLARKE / KENT	8-08-03204	BROOM,MAIN PROEX,8 DOUBLE ROWS	88055990
NILFISK - ADVANCE /AMERICAN LINCOLN / CLARKE / KENT	8-08-03207	BROOM,MAIN NYLON,8 DOUBLE ROWS	88055980
NILFISK - ADVANCE /AMERICAN LINCOLN / CLARKE / KENT	8-08-03209	BROOM,MAIN POLY,8 DOUBLE ROWS	88056020
NILFISK - ADVANCE /AMERICAN LINCOLN / CLARKE / KENT	8-08-03210	BROOM,FIBER-WIRE,HIGH DENSITY	88056000
NILFISK - ADVANCE /AMERICAN LINCOLN / CLARKE / KENT	8-08-03211	BROOM,SIDE NYLON	88056030
NILFISK - ADVANCE /AMERICAN LINCOLN / CLARKE / KENT	8-08-03212	BROOM,SIDE POLY	88056040
NILFISK - ADVANCE /AMERICAN LINCOLN / CLARKE / KENT	8-08-03214	BROOM,POLY/WIRE,8 DOUBLE ROWS	88056010
NILFISK - ADVANCE /AMERICAN LINCOLN / CLARKE / KENT	8-08-03215	BROOM, SIDE POLY	88056100
NILFISK - ADVANCE /AMERICAN LINCOLN / CLARKE / KENT	8-25-08076	FLAP	86805260 / AL-1-SP
NILFISK - ADVANCE /AMERICAN LINCOLN / CLARKE / KENT	8-25-08081	FLAP	86805370 / AL-2-SP
NILFISK - ADVANCE /AMERICAN LINCOLN / CLARKE / KENT	8-25-08086	FLAP	86805380 / AL-3-SP
NILFISK - ADVANCE /AMERICAN LINCOLN / CLARKE / KENT	903USP	DRAIN VALVE	86634390 / VC-72
NILFISK - ADVANCE /AMERICAN LINCOLN / CLARKE / KENT	911690-6	SWITCH	86637460 / EC-20
NILFISK - ADVANCE /AMERICAN LINCOLN / CLARKE / KENT	912019-7	HEAT SINK ASSM.912212	86637320 / CHP-22
NILFISK - ADVANCE /AMERICAN LINCOLN / CLARKE / KENT	94821B	ALUMINUM TANK W/GAUGE	86722010 / PB-9A
NILFISK - ADVANCE /AMERICAN LINCOLN / CLARKE / KENT	98422A	LP TANK (STEEL)	86262920 / PB-9
NILFISK - ADVANCE /AMERICAN LINCOLN / CLARKE / KENT	98629A	WHEEL,6" A.L.COOKE	86637130 / WAC-1
NILFISK - ADVANCE /AMERICAN LINCOLN / CLARKE / KENT	98858A	COUPLER FEMALE	86717420 / PB-13
NILFISK - ADVANCE /AMERICAN LINCOLN / CLARKE / KENT	98978A	VELCRO SNAP TAB(F) (QBA)	86609700 / PB-12
NILFISK - ADVANCE /AMERICAN LINCOLN / CLARKE / KENT	98992A	BELT	86635260 / BLE-11
NILFISK - ADVANCE /AMERICAN LINCOLN / CLARKE / KENT	989USP	PUMP, 110/120 60HZ FLOJET	86201110 / M-108
NILFISK - ADVANCE /AMERICAN LINCOLN / CLARKE / KENT	L08602463	SQ BLADE, GUM, FRONT	86619720 / AD-240-2B
NILFISK - ADVANCE /AMERICAN LINCOLN / CLARKE / KENT	L08603665	BUMPER WHEEL 2 x 7/8"	86602150 / WTN-6
NILFISK - ADVANCE /AMERICAN LINCOLN / CLARKE / KENT	L08603832	REAR BLADE	86638060 / 8.685-682.0
NSS	86601870	CASTER WHEEL	0290491 / WNS-1
NSS	86839430	VACUUM MOTOR GASKET	0294331 / FB2496
NSS	86633440	CARBON BRUSHES	1094691 / ENS-4

Visit our website for the most current and complete OEM interchange



OEM	OEM Part #	Material Description	Graco Part # / Old Graco#
NSS	86626320	BALL BEARING	1099921 / MC-9
NSS	98481820	(K) VAC MOTOR WIH TUBE 1.5" (QBA)	1393201 / VM-7-A
NSS	86854670	24 VOLT 2 STAGE VAC MOTOR	2391051 / VM-29
NSS	98482160	SQUEEGEE SET, URETHANE STRAIGHT	2391261 / NSS-20-2
NSS	86832000	CHARGER 24V. 20AMP	2391341 / CH-2450G
NSS	86602130	FLOAT	2391541 / FNS-1
NSS	86634000	PLUG HOUSING 50A-RED	2391901 / CHP-7-R
NSS	86608740	8"x1 5/8" RUBBER WHEEL (QBA) W/3/4 BRGS(2391931 / WA-5
NSS	86634110	50A.PLUG (RED)911185	2392091 / CHP-2-R
NSS	86844120	MOTOR/GEAR UNIT	2393001 / MTC-5
NSS	86608740	8"x1 5/8" RUBBER WHEEL (QBA) W/3/4 BRGS(2393781 / WA-5
NSS	86854550	24 VOLT 3 STAGE VAC MOTOR	2395571 / VM-23
NSS	86632150	CHARGER 24V. 25A.40512A	2396081 / CH-32
NSS	86801470	CARBON BRUSH W/HOLDER AMETEK	2397571
NSS	86714740	BLADE SQUEEGEE	2492401 / NSS-26V-2A
NSS	86713970	FRONT BLADE	2492521 / NSS-26V-2B
NSS	86714740	BLADE SQUEEGEE	2492531 / NSS-26V-2A
NSS	86845210	SQUEEGEE BLADE, 33" (QBA) CURVED FRONT	2493861 / NSS-26-2A
NSS	86845220	SQUEEGEE BLADE, NEOPRENE (QBA)	2493871 / NSS-26-2B
NSS	86854550	24 VOLT 3 STAGE VAC MOTOR	2499059 / VM-23
NSS	86609780	WIRE HOSE CUFF1-1/2,1-1/2W (QBA)	2599231 / HC-7
NSS	86634400	POTENTIOMETER 740804	2690361 / DSC-2
NSS	86609730	CHARGER PLUG HOUSING (QBA)	2690471 / CHP-9
NSS	86854650	36 VOLT 3 STAGE VAC MOTOR	2690551 / VM-280
NSS	98483150	(k) SQUEEGEE VAC HOSE	2690591 / VHNS-3
NSS	86602390	MASTER SWITCH	2690691 / ENS-6
NSS	86670310	REAR SQUEEGEE	2691001 / NSS-33L-2A
NSS	86710110	MUFFLER FILTER	2691091 / NSS-F1
NSS	86601780	BELT (CHAIN)-NSS	2691211 / BLNS-6
NSS	86602510	PILLOW BLOCK BEARING	2691241 / NSS-B-1
NSS	86609750	CIRCUIT BREAKER 20 AMP (QBA)	2691281 / EA-33
NSS	86608290	CIRCUIT BREAKER 25A (QBA) *	2691291 / ETN-4
NSS	86608610	GRIP-HANDLE 290-1138	2691881 / GRA-2000
NSS	86602220	INDICATOR LIGHT-NSS, GREEN	2691981
NSS	86845020	INDICATOR - LIGHT AMBER	2691991 / NPL-2
NSS	86618730	CASTER W/WHEEL (5-3/8) 56365555,630002	2692581 / WA-1
NSS	86709730	SQUEEGEE FRONT NEO 40.75	2692821
NSS	86859820	BLADE, 3/16 GUM 2-1/8 x 43-1/4	2692831
NSS	86603110	WIPER, SIDE-33	2693141 / NSS-33-WS
NSS	86603120	SPLASHGUARD-33	2693151 / NSS-33-S
NSS	86845370	BLADE-FRONT, CURVED 43" (QBA) (NEO)	2693681 / NSS-33C-2B
NSS	86845360	BLADE-REAR, CURVED (QBA) 43" (TAN GUM)	2693691 / NSS-33C-2A
NSS	86897850	BLADE FRONT 33 CURVED	2693821 / NSS-33L-2B
NSS	86670310	REAR SQUEEGEE	2693831 / NSS-33L-2A
NSS	98484530	(k) CHAIN, ROLLER 40#	2694061 / BLNS-7
NSS	86606570	SPROCKET-DRIVE MOTOR 898550	2695011 / BLC-16
NSS	86854650	36 VOLT 3 STAGE VAC MOTOR	2699154 / VM-280
NSS	86854650	36 VOLT 3 STAGE VAC MOTOR	2699159 / VM-280
NSS	86838680	MOTOR .75 GEAR 36 VOLT	2699179 / F755400
NSS	86609140	3/4 H.P. BRUSH MOTOR	2790081 / F732775

Visit our website for the most current and complete OEM interchange



OEM	OEM Part #	Material Description	Graco Part # / Old Graco#
NSS	86601200	36V 3-STAGE VAC MOTOR (QBA) (119431-13)	2790091 / VM-24
NSS	86606360	MOTOR, TRAVERSE 805254	2790101 / MTC-1
NSS	98480870	(k) VAC HOSE	2790299 / VHNS-1
NSS	86626370	BEARING, BALL (6205-2RS)	2790311 / MC-1-B
NSS	98480230	(k) CHAIN	2790341 / BLNS-4
NSS	86602700	SIDE WIPER-NSS	2790671 / NSS-27-S
NSS	98481050	(k) Squeegee Set-27 (QBA) (STRAIGHT),	2791061 / NSS-27-2
NSS	86609670	SOLUTION VALVE - VNS-1	2791401 / VNS-1
NSS	86602330	GASKET	2791621 / NSS-G-1
NSS	86602340	GASKET	2791641 / NSS-G-2
NSS	86606490	SOLENOID 36V.56395452,	2792021 / EC-43
NSS	86607790	SOLENOID 36V.6POLE 788147	2792031 / EC-81
NSS	86607830	TOGGLE SWITCH	2792041 / EC-64
NSS	86634590	SWITCH-F & R	2792051 / ENS-3
NSS	98484460	(k)CHARGER PLUG W/WIRES	2792091 / CHP-2-ANS
NSS	86634400	POTENTIOMETER 740804	2792661 / DSC-2
NSS	98481050	(k) Squeegee Set-27 (QBA) (STRAIGHT)	2793009 / NSS-27-2
NSS	86633920	40 LINK, CONN.	2795211 / BLAL-9
NSS	86633840	PAD HOLDER-CLIP 56182058	2795231 / PH-3-P
NSS	86601910	DRAIN PLUG 1 1/2"621324	2795621 / VTN-1
NSS	86623310	CARBON BRUSH 833474	2797561 / F732775-1
NSS	86845030	SQUEEGEE SET	3092199 / NSS-14T-5
NSS	86845120	SQUEEGEE SET (QBA)	3092259 / NSS-18T-5
NSS	86602150	BUMPER WHEEL 2 x 7/8"	3096741 / WTN-6
NSS	98481060	(k)SQUEEGEE SET-33(QBA) (STRAIGHT)38"	3390261 / NSS-33-2
NSS	98480240	(k) CHAIN 31"	3390401 / BLNS-5
NSS	86838680	MOTOR .75 GEAR 36 VOLT	3390771 / F755400
NSS	88056940	PAD DRIVER 16"	3390891 / BRN-33-AG
NSS	86609030	GEAR BOX 54238A	3391181 / BLC-24
NSS	86608610	GRIP-HANDLE 290-1138	3392101 / GRA-2000
NSS	86858730	WIPER (QBA)	3392431 / NSS-3330-S
NSS	98483250	(K) CHAIN, #40(63 LINKS+CONN.LINK)	3392949 / BLNS-8
NSS	86602510	PILLOW BLOCK BEARING	3393121 / NSS-B-1
NSS	86258480	VAC MOTOR, 36V 5.7 3ST TD	3393361 / VM-280A+
NSS	98481060	(k)SQUEEGEE SET-33(QBA) (STRAIGHT)38"	3394109 / NSS-33-2
NSS	86601910	DRAIN PLUG 1 1/2"621324	3790641 / VTN-1
NSS	86634080	S.B. PLUG 50A grey 911185	3795001 / CHP-2
NSS	86829020	BELT(EQ. TO NSS#42-094-1)	4290941 / BLNS-1
NSS	86616310	4X2 POLY WHEEL W/BRG(F)	4490391 / WA-1-W
NSS	86618730	CASTER W/WHEEL (5-3/8) 56365555, 630002	4490501 / WA-1
NSS	86608740	8"x1 5/8" RUBBER WHEEL (QBA) W/3/4 BRGS(4490511 / WA-5
NSS	86608530	CIRCUIT BREAKER-70 AMP	4490701 / EA-70
NSS	86719680	36V 20 AMPS. CHARGER W/50AMP GRAY	4490991 / CH-3650G
NSS	86006370	Relay 36VDC 100AMP HVY DUTY	4491011 / EA-80
NSS	86608650	AMMETER, DC	4491041 / EAM-4
NSS	86608640	METER-BATT.COND. 56448677	4491051 / EAM-3
NSS	86608900	CIRCUIT BREAKER-60 AMP	4491081 / EA-71
NSS	86606590	SWITCH BRUSH	4491101 / EA-8
NSS	86827890	BATTERY CABLE	4491111 / BCSN415
NSS	86608530	CIRCUIT BREAKER-70 AMP	4491131 / EA-70

Visit our website for the most current and complete OEM interchange



OEM	OEM Part #	Material Description	Graco Part # / Old Graco#
NSS	86719680	36V 20 AMPS. CHARGER W/50AMP GRAY	4491771 / CH-3650G
NSS	86634080	S.B. PLUG 50A grey 911185	4491901 / CHP-2
NSS	86619250	GASKET-VAC TOP 56209325	4690101 / AD-G-9
NSS	86854760	120 VOLT 3 STAGE VAC MOTOR	4890399 / VM-33
NSS	86602940	SWITCH,VAC-NSS	4890751 / ENS-5
NSS	86854740	120 VOLT 3 STAGE VAC MOTOR	4894641 / VM-31
NSS	86834410	CARBON BRUSH (F) (QBA)	5293651 / EC-51
NSS	86695500	CORD 75' 14/3 YELLOW ST 600V	5293791 / E-4752Y
NSS	98480350	(k) CARBON BRUSH (SET 4)	5294051 / EA-75
NSS	86634620	SWITCH	5390211 / EA-32
NSS	86246740	LOCK, PAD DRIVER BLUE	5990601 / PH-6
NSS	86005070	Lock PAD CENTER SNAP,TWO STEP	5990721 / PH-8
NSS	86005070	Lock PAD CENTER SNAP,TWO STEP	5990731 / PH-8
NSS	86635230	CLUTCH ELEC. 12 VOLT	6190201 / PB-155
NSS	86636780	BONNET FILTER, SHORT 3.25" X 9.5"	6191041 / PB-162
NSS	86891370	SOLENOID -STARTER 12V	6191061 / PB-165
NSS	86618730	CASTER W/WHEEL (5-3/8) 56365555,630002	6492061 / WA-1
NSS	86608730	WHEEL 6 X 1-1/2 3/4"BRGS	6591111 / WA-2
NSS	86636690	REGULATOR,CENTURY G85-4012	6591481 / PB-153
NSS	86633130	BAG,PAPER 6QT.10/PK	6790091 / PBT-1
NSS	86840200	BLADE, TAN GUM (QBA) 2"x1/8"x40" - 11 Ho	6890161 / FNS-2
NSS	86839920	FILTER, SAFETY - NSS MARSHALL	6890161 / FNS-2
NSS	86848550	BAGS, FILTER (10 PACK) - MARSHALL 14/18	6890241 / PBNS-1
NSS	86652930	POWER CORD	7292941 / E-40Y
NSS	88052250	Squeegee Blade, Red, 1/4 x 2 - 1/8 x 39 NSS	7693371 /
NSS	88052270	SQUEEGEE BLADE, RED 1/4X2-1/8X46-5/8 NSS	7693381
NSS	86854980	MOTOR, VAC (QBA) (NSS CHAMP ZS 35) (LAMB	7693851 / VM-56
NUMATIC	NVM1C	BAGS, FILTER (10 PACK) NUMATIC HENRY, HO	86848530 / PBN-1
NUMATIC	NVM2B	SP VAC BAGS (NVM 2B) 10PK NORTH AMERICAN	86857900
ONAN	311931	SWITCH,KEY	86636760 / PB-92
ONAN	1403009	AIR FILTER P248	86635180 / PB-110
ONAN	140225501	FILTER WRAPPER P248	86636860 / PB-111
ONAN	102-1462	VALVE COVER GASKET E124	86647690 / PB-100
ONAN	110-3181	HEAD GASKET	86636240 / PB-115
ONAN	110-3591	HEADGASKET	86635470 / PB-99
ONAN	110-3709	GASKET,VALVE GASKET	86642090 / PB-116
ONAN	122-0645	OIL FILTER	86636360 / PB-109
ONAN	122-0737	OIL FILTER -E124	86636920 / PB-93
ONAN	123-0954	BREATHER VALVE	86635710 / PB-118
ONAN	140-2255-01	FILTER WRAPPER P248	86636860 / PB-111
ONAN	140-2255-1	FILTER WRAPPER P248	86636860 / PB-111
ONAN	140-2335-01	PRE FILTER (WRAPPER) *ONAN*	86636180 / PB-75
ONAN	140-2748-01	FOAM WRAPPER	86636840 / PB-95
ONAN	140-2761	AIR CLEANER KNOB E124	86848120 / PB-96
ONAN	140-2825-01	FILTER PRE CLEANER	86636830 / PB-73
ONAN	140-3009	AIR FILTER P248	86635180 / PB-110
ONAN	140-3010	AIR CLEANER 124	86635190 / PB-94
ONAN	140-3023	AIR INTAKE BONNET P248	86636850 / PB-112
ONAN	140-3111	AIR FILTER (ONAN)	86636230 / PB-74
ONAN	148-1025	REGULATOR,CENTURY G85-4012	86636690 / PB-153

Visit our website for the most current and complete OEM interchange



OEM	OEM Part #	Material Description	Graco Part # / Old Graco#
ONAN	154-2495	GASKET,INTAKE	86635520 / PB-117
ONAN	154-2746	GASKET,EXHAUST P248	86635510 / PB-105
ONAN	155-2378	GASKET	86635540 / PB-90
ONAN	155-2429-02	SPARK ARRESTOR P248V	86635720 / PB-107
ONAN	167-0272	SPARK PLUG RS17YX	86636440 / PB-106
ONAN	167-1602	IGNITION LEADS	86635680 / PB-114
ONAN	308-0385	SWITCH,KEY	86636760 / PB-92
ONAN	308-0490	KEY P248	86636210 / PB-108
ONAN	31-1931	SWITCH,KEY	86636760 / PB-92
ONAN	504-0186	OIL DRAIN VALVE	86635760 / PB-97
PACIFIC STEAMEX	3703	SWITCH	86634180 / ES-1
PACIFIC STEAMEX	S122R	FLOJET (100PSI FAN COOL) 9" (QBA)	86842630 / M-41
PACIFIC STEAMEX	S400P	DRAIN VALVE	86634390 / VC-72
PACIFIC STEAMEX	S400P5	NUT,DRAIN VALVE	86634690 / VC-72-N
PACIFIC STEAMEX	S400P6	GASKET	86723890 / VC-72-G
PACIFIC STEAMEX	S400PB	DRAIN VALVE	86634390 / VC-72
PACIFIC STEAMEX	S400PB4	ELBOW 2" VALVE (1019-2)	86852900 / VC-72-E
PACIFIC STEAMEX	S446P	SEAL(GASKET)2PCS. 3/8"GUM*OD=5&1/8"XID=3	86850740 / S-G-1
PACIFIC STEAMEX	S519P	SWITCH, ROCKER-NSS	86634200 / ES-2
PACIFIC STEAMEX	S590P	PUMP-LITTLE GIANT (QBA)	86842540 / M-20
PACIFIC STEAMEX	S591P	120 VOLT 2 STAGE VAC MOTOR (VM-13)	86854420 / VM-13
PACIFIC STEAMEX	S591P1	BRUSH MECH. EA. (33326-1 REP'L 33308)	86801380
PACIFIC STEAMEX	S611P	3 STAGE VAC MTR (QBA) (116103-00,117507-	86854460 / VM-14
PERFECT	15-1803	BAG,PAPER 10QT.10/PK	86633140 / PBT-2
PERFECT	PP1	HOOD	86641600 / VCP-35
PERFECT	PP10	SPRING	86723940 / VCP-33
PERFECT	PP11	BASE KIT	86641610 / VCP-14
PERFECT	PP11A	BASE ASSEMBLY, RED 16"	86853000 / VCP-15
PERFECT	PP12	COVER, WHEEL	86853370 / VCP-50
PERFECT	PP13	SWITCH-PUSH	86641660 / VCP-2
PERFECT	PP14	GASKET	86647890 / VCP-39
PERFECT	PP15	AIR INLET DUCT, LEFT SIDE	86852960 / VCP-11
PERFECT	PP16	ADAPTER RETAINER SPRING	86723960 / VCP-9
PERFECT	PP17	COVER, FAN CHAMBER, CLEAR	86853100 / VCP-26
PERFECT	PP19	BUMPER, 12" (QBA)	86853250 / VCP-4
PERFECT	PP19A	BUMPER, 16" (QBA)	86853360 / VCP-5
PERFECT	PP2	BUSHING, STRAIN RELIEF EACH	86853380 / VCP-51
PERFECT	PP20	REAR WHEEL/AXLE ASSEMBLY	86853300 / VCP-44
PERFECT	PP21	PUSH NUT (EA)	86853270 / VCP-41
PERFECT	PP22	WHEEL, REAR	86853290 / VCP-43
PERFECT	PP23A	DRIVE BELT, F/COMM UPRIGHT VACS SM12-SM1	86816370 / BLE-3
PERFECT	PP24	WHEEL, FRONT	86853150 / VCP-30
PERFECT	PP25	CARBON BRUSH (EACH)	86853210 / VCP-36
PERFECT	PP26	MOTOR BASE ASSEMBLY	86853230 / VCP-38
PERFECT	PP27	WASHER, FAN (EA) (53148)	86853110 / VCP-27
PERFECT	PP29	PULLEY	86853260 / VCP-40
PERFECT	PP3	SCREW, SHOULDER	86853330 / VCP-47
PERFECT	PP30	HANDLE GRIP(GREY)	86853160 / VCP-31
PERFECT	PP31	(k) CORD RETAINER HOOK SET	98482050 / VCP-23
PERFECT	PP32	HANDLE, UPPER ASSEMBLY W/GRIP	86853350 / VCP-49

Visit our website for the most current and complete OEM interchange



OEM	OEM Part #	Material Description	Graco Part # / Old Graco#
PERFECT	PP33	SCREW W/NUT	86674170 / VCP-46
PERFECT	PP34	HANDLE TUBE, LOWER	86853190 / VCP-34
PERFECT	PP35	SPRING, STRAIN RELIEF	86723950 / VCP-48
PERFECT	PP36	CORD, 18-3/50' BEIGE	86633290 / VCP-6
PERFECT	PP38A	DISTRIBUTOR ASSEMBLY 16"	86853090 / VCP-24
PERFECT	PP38A	DISTRIBUTOR ASSEMBLY, FLAT 12"	86853070 / VCP-22
PERFECT	PP39	CAP, DISTRIBUTOR (RUBBER) EA.	86853060 / VCP-20
PERFECT	PP4	KNOB	86644520 / VCP-10
PERFECT	PP40	BRISTLE STRIP (SET) (Blu/Org)	86641620 / VCP-18
PERFECT	PP40A	BRUSHSTRIP (Blk)	86656820 / VCP-19
PERFECT	PP41	CAP, DISTRIBUTOR END (METAL)	86853310 / VCP-45
PERFECT	PP42	BOTTOM PLATE	86659480 / VCP-16
PERFECT	PP42A	BOTTOM PLATE ASSMBLY, 16"	86723910
PERFECT	PP43	BLACK CLOTH BAG, TOP FILL	86720420 / FBE-84-B
PERFECT	PP6	AIR INLET DUCT, RIGHT SIDE	86852970 / VCP-12
PERFECT	PP7	MOTOR ASSY	86649300 / VCP-37
PERFECT	PP8	FOOT PEDAL SPRING	86723930 / VCP-29
PERFECT	PP9	PEDAL, FOOT	86853120 / VCP-28
PIONEER	IN-2489	VELCRO SKIRT	86635550 / PB-46
PIONEER	MP105900	LP TANK (STEEL)	86262920 / PB-9
PIONEER	MP106000	LP TANK (STEEL)	86262920 / PB-9
PIONEER	MP109700	BONNET FILTER, SHORT 3.25" X 9.5"	86636780 / PB-162
PIONEER	MP2310	STARTER	86633430 / PB-3
PIONEER	MP3220	FUEL FILTER PRO	86634470 / PB-14
PIONEER	MP3600	REGULATOR	86636640 / PB-1
PIONEER	MP4200	LP TANK (STEEL)	86262920 / PB-9
PIONEER	MP4500	COUPLER FEMALE	86717420 / PB-13
PIONEER	MP4755	BELT TENSIONER	86717780 / PB-8
PIONEER	MP4787	CLUTCH ELEC. 12 VOLT	86635230 / PB-155
PIONEER	MP6300	GRIP-HANDLE 290-1138	86608610 / GRA-2000
PIONEER	MP7950	BELT	86724930 / BLE-2
PIONEER	MP7975	BELT	86634640 / BLE-4
PIONEER	MP8050	BELT	86828800 / BLE-1
PIONEER	MP8051	BELT	86711460 / BLAL-16
PIONEER	MP8075	BELT	86635310 / BLE-6
PIONEER	MP8080	BELT	86635260 / BLE-11
PIONEER	MP8083	BELT	86635330 / BLE-5
PIONEER	MP8150	BELT, 49"	86635320 / BLE-10
PIONEER	MP8310	VELCRO SNAP TAB(F) (QBA)	86609700 / PB-12
PIONEER	MP9420	WHEEL	86634410 / PB-5
PIONEER	MP9450	WHEEL 5IN. H.D.	86847790 / PB-6-W
PIONEER	MP9475	CASTER 3 SWIVEL	86609480 / PB-39
PIONEER	MP9600	2 IN. DUST FILTER	86634550 / PB-15
PIONEER	PA2900	CO DETECTOR	86721980 / PB-157
PIONEER	TB2090	BELT	86635370 / BLE-9
POWERFLITE	ER127	ADAPTER RETAINER SPRING	86723960 / VCP-9
POWERFLITE	ER138	BRUSHSTRIP (Blk)	86656820 / VCP-19
POWERFLITE	ER17	FAN, LEXAN	86711430 / FE-1
POWERFLITE	ER17A	WASHER, FAN (EA) (53148)	86853110 / VCP-27
POWERFLITE	ER195	CORD, 18-3/50' BEIGE	86633290 / VCP-6

Visit our website for the most current and complete OEM interchange



OEM	OEM Part #	Material Description	Graco Part # / Old Graco#
POWERFLITE	ER196A	(k) CORD RETAINER HOOK SET	98482050 / VCP-23
POWERFLITE	ER199	HANDLE, UPPER ASSEMBLY W/GRIP	86853350 / VCP-49
POWERFLITE	ER2	PEDAL, FOOT	86853120 / VCP-28
POWERFLITE	ER20	SCREW W/NUT	86674170 / VCP-46
POWERFLITE	ER2000	HANDLE TUBE, LOWER	86853190 / VCP-34
POWERFLITE	ER205	SCREW, SHOULDER	86853330 / VCP-47
POWERFLITE	ER214	BOTTOM PLATE	86659480 / VCP-16
POWERFLITE	ER217	BRISTLE STRIP (SET) (Blu/Org)	86641620 / VCP-18
POWERFLITE	ER3	FOOT PEDAL SPRING	86723930 / VCP-29
POWERFLITE	ER306	HANDLE GRIP(GREY)	86853160 / VCP-31
POWERFLITE	ER331	BUSHING, STRAIN RELIEF EACH	86853380 / VCP-51
POWERFLITE	ER333	COVER, WHEEL	86853370 / VCP-50
POWERFLITE	ER35	GASKET	86647890 / VCP-39
POWERFLITE	ER37	WHEEL, FRONT	86853150 / VCP-30
POWERFLITE	ER392	CAP, DISTRIBUTOR END (METAL)	86853310 / VCP-45
POWERFLITE	ER393	DISTRIBUTOR ASSEMBLY, FLAT 12"	86853070 / VCP-22
POWERFLITE	ER394	DISTRIBUTOR ASSEMBLY 16"	86853090 / VCP-24
POWERFLITE	ER4	SPRING	86723940 / VCP-33
POWERFLITE	ER400	PAPER BAG (3 PACK) (QBA)	86848300 / PBC-300
POWERFLITE	ER41	MOTOR BASE ASSEMBLY	86853230 / VCP-38
POWERFLITE	ER42	CARBON BRUSH (EACH)	86853210 / VCP-36
POWERFLITE	ER514	KNOB	86644520 / VCP-10
POWERFLITE	ER54	RED ZIPPER BAG W/SPRING	86717490 / FBE-84-Z
POWERFLITE	ER557	BASE KIT	86641610 / VCP-14
POWERFLITE	ER559	BASE ASSEMBLY, RED 16"	86853000 / VCP-15
POWERFLITE	ER561	BUMPER, 12" (QBA)	86853250 / VCP-4
POWERFLITE	ER562	BUMPER, 16" (QBA)	86853360 / VCP-5
POWERFLITE	ER565	WHEEL, REAR	86853290 / VCP-43
POWERFLITE	ER568	PUSH NUT (EA)	86853270 / VCP-41
POWERFLITE	ER60	BLACK CLOTH BAG, TOP FILL	86720420 / FBE-84-B
POWERFLITE	ER600	KNOB	86644520 / VCP-10
POWERFLITE	ER603	SWITCH-PUSH	86641660 / VCP-2
POWERFLITE	ER605	HOOD	86641600 / VCP-35
POWERFLITE	ER611	BOTTOM PLATE ASSMBLY, 16"	86723910
POWERFLITE	ER617	HANDLE SOCKET ASSEMBLY W/ SPRING	86853170 / VCP-32
POWERFLITE	ER620	AIR INLET DUCT, RIGHT SIDE	86852970 / VCP-12
POWERFLITE	ER622	AIR INLET DUCT, LEFT SIDE	86852960 / VCP-11
POWERFLITE	ER632	MOTOR ASSY	86649300 / VCP-37
POWERFLITE	ER633	PULLEY	86853260 / VCP-40
POWERFLITE	ER644	COVER, FAN CHAMBER, CLEAR	86853100 / VCP-26
POWERFLITE	ER66	FAN, LEXAN	86711430 / FE-1
POWERFLITE	ER7B	DRIVE BELT, F/COMM UPRIGHT VACS SM12-SM1	86816370 / BLE-3
POWERFLITE	M1376	CORD,18-3/50' BEIGE	86633290 / VCP-6
POWERFLITE	M1377	CORD,50 '18-3 BLACK	86633280 / VCP-7
POWERFLITE	M1400	CORD 75' 14/3 YELLOW ST 600V	86695500 / E-4752Y
PROTEAM	68019	SWITCH, VP6/10	86199120 / SPT-1
PROTEAM	100024	FILTER BAG	86677560 / PBT-4
PROTEAM	100030	FILTER ASSY	86647750 / FPT-1
PROTEAM	100327	VAC MOTOR(115923) (QBA) 120V 2STAGE	86854970 / VM-55
PROTEAM	100331	BAG,PAPER 10QT.10/PK	86633140 / PBT-2

Visit our website for the most current and complete OEM interchange



OEM Interchange

OEM	OEM Part #	Material Description	Graco Part # / Old Graco#
PROTEAM	100422	VAC MOTOR(115923) (QBA) 120V 2STAGE	86854970 / VM-55
PROTEAM	100431	BAG,PAPER 6QT.10/PK	86633130 / PBT-1
PROTEAM	100564	FILTER BAG	86677560 / PBT-4
PROTEAM	100565	BAG, CLOTH (10 qt)COACHVAC, SUPER COACH,	86848640 / PBT-5
PROTEAM	100636	HOSE CUFF SWIVEL (F)	86609570 / HC-2-S
PROTEAM	102784	FILTER ASSY	86647750 / FPT-1
PROTEAM	103191	FILTER,PAPER BAG,EVEREST,MICRO LINED 10	86806220
PROTEAM	101610PT	SWITCH	86644830
PULLMAN HOLT	B000479	120 VOLT 2 STAGE VAC MOTOR	86854820 / VM-4
PULLMAN HOLT	B100182	SWITCH BRUSH	86606590 / EA-8
PULLMAN HOLT	B200180	CIRCUIT BREAKER-60 AMP	86608900 / EA-71
PULLMAN HOLT	B200185	8"x1 5/8" RUBBER WHEEL (QBA) W/3/4 BRGS(86608740 / WA-5
PULLMAN HOLT	B200191	BATTERY CABLE	86827720 / BC425R
PULLMAN HOLT	B701385	GASKET, 20/24 VAC MOTOR	86003870 / TN-G-6
PULLMAN HOLT	B7529-1	SQUEEGEE BLADE (GUM)	86849020 / PUL-80-3A
PULLMAN HOLT	B7529P-2	SQUEEGEE BLADE (GUM)	86849030 / PUL-80-3B
PULLMAN HOLT	B7529P-3	SQUEEGEE BLADE (GUM)	86849040 / PUL-80-3C
PULLMAN HOLT	B931614	SQUEEGEE BLADE (NEO)	86849000 / PUL-2000-3C
PULLMAN HOLT	B931692	SQUEEGEE BLADE (GUM)	86848980 / PUL-2000-3A
Robin Subaru	010-50802-90	STUD	86893960
Robin Subaru	021-31800-10	GASKET, DIPSTICK	86893760
Robin Subaru	044-04200-30	OIL SEAL	86893740
Robin Subaru	132-07AA0-50	SEAL-INTAKE VALVEE	86893970
Robin Subaru	132-11AA0-50	SEAL-EXHAUST VALVE	86893980
Robin Subaru	210-35501-11	GASKET, EXHAUST	86893730
Robin Subaru	248-65801-00	OIL FILTER	86893780
Robin Subaru	261-65902-A0	OIL FILTER	86636100 / PB-139
Robin Subaru	263-13201-02	CYLINDER HEAD 1	86893930
Robin Subaru	263-13201-A1	CYLINDER HEAD 1	86893930
Robin Subaru	263-13301-02	CYLINDER HEAD 2	86893940
Robin Subaru	263-13301-A1	CYLINDER HEAD 2	86893940
Robin Subaru	263-14201-03	VALVE GUIDE	86893950
Robin Subaru	263-14211-03	VALVE GUIDE	86893950
Robin Subaru	263-15021-01	HEAD GASKET 1	86894600
Robin Subaru	263-15121-01	HEAD GASKET 2	86894610
Robin Subaru	263-16006-03	GASKET-BREATHER PLATE	86894000
Robin Subaru	263-16011-A3	GASKET-MAIN BEARING COVER	86893990
Robin Subaru	263-16101-A3	GASKET, ROCKER COVER	86774160
Robin Subaru	263-32610-A1	AIR FILTER -- ROBIN	86778000
Robin Subaru	263-35201-A1	GASKET, EXHAUST	86893730
Robin Subaru	263-35503-A3	GASKET, INTAKE MANIFOLD	86774190
Robin Subaru	263-63611-01	DIPSTICK, OIL	86893750
Robin Subaru	263-65101-A2	TUBE, OIL FILL	86893770
Robin Subaru	263-70502-A0	STARTER	86893790
Robin Subaru	263-71901-01	REGULATOR, VOLTAGE	86893820
Robin Subaru	263-71903-A1	REGULATOR, VOLTAGE	86893820
Robin Subaru	263-78201-01	IGNITION COIL	86893810
Robin Subaru	263-79411-A1	CHARGE COIL	86894010
Robin Subaru	270-35201-01	GASKET, EXHAUST	86893730
Robin Subaru	X65-01403-00	SPARK PLUG N9YC	86893800

Visit our website for the most current and complete OEM interchange



OEM	OEM Part #	Material Description	Graco Part # / Old Graco#
SANDIA	10-0006	BAG,PAPER 10QT.10/PK	86633140 / PBT-2
SANDIA	10-0197	BAG,PAPER 6QT.10/PK	86633130 / PBT-1
STAR	105003	BLADE, GUM	86851440 / STR-58-4A
STAR	105005	BLADE, GUM 2-1/2"x3/8"x17-1/4" - 17 Hole	86851450 / STR-58-4B
STAR	105007	BLADE, GUM 2-3/4"x1/4"x39-1/2" - 16 Hole	86851460 / STR-58-4C
STAR	105029	BLADE, GUM 3"x3/8"x16" - 8 Holes	86851510 / STR-58-6D
STAR	105054	BLADE, TAN GUM 4"x3/8"x84" -36 Holes	86851650 / STR-75-10A
STAR	105056	BLADE, NEO 3-1/2"x3/8"x84" -36 Holes	86851660 / STR-75-10B
STAR	105059	BLADE, TAN GUM 4"x3/8"x16" -8 Holes	86851670 / STR-75-10C
STAR	105061	BLADE, NEO 3-1/2"x3/8"x16" -8 Holes	86851680 / STR-75-10D
STAR	105062	BLADE, TAN GUM 4"x3/8"x18-1/2" -8 Holes	86851690 / STR-75-10E
STAR	105064	BLADE, NEO 3-1/2"x3/8"x18-1/2" -8 Holes	86851700 / STR-75-10F
STAR	105091	SQUEEGEE BLADE (NEO)	86851200 / STR-33S-4A
STAR	105092	SQUEEGEE BLADE (GUM)	86851170 / STR-33R-4C
STAR	105093	SQUEEGEE BLADE (GUM)	86851150 / STR-33R-4A
STAR	105138	SQUEEGEE BLADE 9GUM)	86851210 / STR-33S-4B
STAR	105139	SQUEEGEE BLADE	86851220 / STR-33S-4C
STAR	105263	SQUEEGEE BLADE (GUM)	86851330 / STR-46R-7A
STAR	105264	SQUEEGEE BLADE (GUM)	86851340 / STR-46R-7B
STAR	105328	BLADE, GUM 2-1/2"x1/4"x35-3/4" -17 Holes	86851600 / STR-60S-10B
STAR	105329	BLADE, GUM 2-3/4"x1/4"x39-1/2" -17 Holes	86851590 / STR-60S-10A
STAR	105330	BLADE, GUM 2-7/8"x1/4"x23" - 10 Holes	86851540 / STR-60R-10B
STAR	105331	BLADE, GUM 2-3/4"x1/4"x11" - 4 Holes	86851550 / STR-60R-10C
STAR	105332	BLADE, NEO 2"x14"x32"-15 Holes	86851630 / STR-60S-10E
STAR	105338	SQUEEGEE BLADE (GUM)	86851390 / STR-46S-7A
STAR	105339	SQUEEGEE BLADE (GUM)	86851400 / STR-46S-7B
STAR	105340	SQUEEGEE BLADE (NEO)	86851410 / STR-46S-7C
STAR	105461	SQUEEGEE -GUM	86851290 / STR-460N-3A
STAR	105462	SQUEEGEE-GUM	86851310 / STR-460N-3C
STAR	105711	SQUEEGEE BLADE 9GUM)	86851210 / STR-33S-4B
STAR	105717	SQUEEGEE BLADE (NEO)	86851270 / STR-460-3C
TENNANT - CASTEX / NOBLES	3426	24V VAC MOTOR (QBA) (116155-00)	86601190 / VM-1
TENNANT - CASTEX / NOBLES	05724	BRUSH ASSY, DISK, 16" NYLON	88055150
TENNANT - CASTEX / NOBLES	05725	BRUSH ASSY, DISK,16"STIFF POLY	88055160
TENNANT - CASTEX / NOBLES	05726	BRUSH ASSY, DISK, 16" GRIT	88055170
TENNANT - CASTEX / NOBLES	10204	AMMETER (2000S)	86637310 / CHP-10
TENNANT - CASTEX / NOBLES	10207	RECTIFIER (QBA)	86832520 / CHP-40
TENNANT - CASTEX / NOBLES	10914	36V 3-STAGE VAC MOTOR (QBA) (119431-13)	86601200 / VM-24
TENNANT - CASTEX / NOBLES	10925	Connector,Fem.2CAV,MP360 Sealed	86882570
TENNANT - CASTEX / NOBLES	10926	Terminal,Fem.MP630,14GA (Each)	86882580
TENNANT - CASTEX / NOBLES	11233	120 VOLT VAC MOTOR	86855020 / VM-7
TENNANT - CASTEX / NOBLES	11586	120V,12.7 AMP,2 STAGE VACUUM MTR. (QBA)	86854410 / VM-12
TENNANT - CASTEX / NOBLES	11756	BRUSH & BRUSH HOLDER (GREEN HOLDER) AMET	86801440
TENNANT - CASTEX / NOBLES	11771	BRUSH ASSY, DISK,18" POLY	88054630
TENNANT - CASTEX / NOBLES	11772	BRUSH ASSY, DISK,18" GRIT	88054640
TENNANT - CASTEX / NOBLES	11773	BRUSH ASSY, DISK,18" NYLON	88054650
TENNANT - CASTEX / NOBLES	12964	CIRCUIT BREAKER (17 AMP)	86608510 / EA-24
TENNANT - CASTEX / NOBLES	14301	VACUUM MOTOR	86686220 / VM-10
TENNANT - CASTEX / NOBLES	14571	SQUEEGEE ASSY, REAR	88060790
TENNANT - CASTEX / NOBLES	14575	Squeegee Assy., front	88060780

Visit our website for the most current and complete OEM interchange



OEM	OEM Part #	Material Description	Graco Part # / Old Graco#
TENNANT - CASTEX / NOBLES	14699	120 VOLT 2 STAGE VAC MOTOR	86854820 / VM-4
TENNANT - CASTEX / NOBLES	14800	120 VOLT VAC MOTOR	86855020 / VM-7
TENNANT - CASTEX / NOBLES	14838	Spring, Wire-Brush Retaining	88055210
TENNANT - CASTEX / NOBLES	14838	SPRING,WIRE 0.16D,BRUSH RETAINING	88055210
TENNANT - CASTEX / NOBLES	14953	BRUSH ASSY, DISK 20"POLY	88057840
TENNANT - CASTEX / NOBLES	14967	BRUSH ASSY, DISK 20" NYLON	88057850
TENNANT - CASTEX / NOBLES	15539	HUB, DRIVE,BRUSH, 3HOLE 5.8BC[6T	88055220
TENNANT - CASTEX / NOBLES	15539	HUB, DRIVE,BRUSH, 3HOLE 5.8BC[6T	88055220
TENNANT - CASTEX / NOBLES	16272	36V 3-STAGE VAC MOTOR (QBA) (119431-13)	86601200 / VM-24
TENNANT - CASTEX / NOBLES	16277	36V 3-STAGE VAC MOTOR (QBA) (119431-13)	86601200 / VM-24
TENNANT - CASTEX / NOBLES	16278	36V 2 STAGE VAC MTR (QBA) (116156-00)	86854510 / VM-2
TENNANT - CASTEX / NOBLES	17305	ADAPTER RETAINER SPRING	86723960 / VCP-9
TENNANT - CASTEX / NOBLES	17363	36 VOLT 3 STAGE VAC MOTOR	86854650 / VM-280
TENNANT - CASTEX / NOBLES	18645	5" POLY SWIVEL CASTER(F) (QBA)	86606110 / WC-3
TENNANT - CASTEX / NOBLES	19417	SWITCH	86652590 / ETN-1
TENNANT - CASTEX / NOBLES	20361	15A.CIRCUIT BRK.740130	86618740 / EA-34
TENNANT - CASTEX / NOBLES	20759	FAN, LEXAN	86711430 / FE-1
TENNANT - CASTEX / NOBLES	20762	SPRING,STRAIN RELIEF	86723950 / VCP-48
TENNANT - CASTEX / NOBLES	20764	HANDLE, UPPER ASSEMBLY W/GRIP	86853350 / VCP-49
TENNANT - CASTEX / NOBLES	20767	HANDLE TUBE, LOWER	86853190 / VCP-34
TENNANT - CASTEX / NOBLES	20768	CORD,18-3/50' BEIGE	86633290 / VCP-6
TENNANT - CASTEX / NOBLES	20769	HANDLE SOCKET ASSEMBLY W/ SPRING	86853170 / VCP-32
TENNANT - CASTEX / NOBLES	21637	BOTTOM PLATE	86659480 / VCP-16
TENNANT - CASTEX / NOBLES	22117	CARBON BRUSH (F) (QBA)	86834410 / EC-51
TENNANT - CASTEX / NOBLES	23371	120 VOLT 2 STAGE VAC MOTOR	86854820 / VM-4
TENNANT - CASTEX / NOBLES	23867	120 VOLT VAC MOTOR	86855020 / VM-7
TENNANT - CASTEX / NOBLES	23867	120 VOLT VAC MOTOR	86855020 / VM-7
TENNANT - CASTEX / NOBLES	23953	SP. VAC MOTOR,220V.	86634840 / VM-21
TENNANT - CASTEX / NOBLES	24248	120 VOLT 2 STAGE VAC MOTOR (VM-13)	86854420 / VM-13
TENNANT - CASTEX / NOBLES	24299	BRACKET, RETAINER SPRING	88055200
TENNANT - CASTEX / NOBLES	24304	SQUEEGEE KIT,REAR RED BLADE ASSY W/SEALS	98486440
TENNANT - CASTEX / NOBLES	24373	36V 3-STAGE VAC MOTOR (QBA) (119431-13)	86601200 / VM-24
TENNANT - CASTEX / NOBLES	24373	36V 3-STAGE VAC MOTOR (QBA) (119431-13)	86601200 / VM-24
TENNANT - CASTEX / NOBLES	24881	S.B. PLUG 50A grey 911185	86634080 / CHP-2
TENNANT - CASTEX / NOBLES	25151	120 VOLT 2 STAGE VAC MOTOR (VM-13)	86854420 / VM-13
TENNANT - CASTEX / NOBLES	27249	24 VOLT 2 STAGE VAC MOTOR	86854670 / VM-29
TENNANT - CASTEX / NOBLES	27257	KNOB, 5/16-18 4 PRONG	86004790 / SPA-3
TENNANT - CASTEX / NOBLES	27260	BLADE,URE.1-3/8"x3/32"x24-8 Holes/45NOTC	86844440 / N-20-4A
TENNANT - CASTEX / NOBLES	27261	BLADE, URETHANE SERRATED (QBA) 1-3/8"x3/	86844450 / N-20-4B
TENNANT - CASTEX / NOBLES	27859	36V 2 STAGE VAC MTR (QBA) (116156-00)	86854510 / VM-2
TENNANT - CASTEX / NOBLES	28386	VAC MOTOR	86623200 / VM-42
TENNANT - CASTEX / NOBLES	28657	SWITCH N.C./N.O.(PRES.)	86652610 / EA-31
TENNANT - CASTEX / NOBLES	30241	BRUSH ASSY, DISK,16"POLY	88054660
TENNANT - CASTEX / NOBLES	32506	LOCK, PAD DRIVER BLUE	86246740 / PH-6
TENNANT - CASTEX / NOBLES	32710	CHARGER 24V. 20AMP	86832000 / CH-2450G
TENNANT - CASTEX / NOBLES	32710	CHARGER 24V. 20AMP	86832000 / CH-2450G
TENNANT - CASTEX / NOBLES	33370	VAC MOTOR, (QBA) 7.2",DB,2 STG, TYPE D P	86855060 / VM-9
TENNANT - CASTEX / NOBLES	33370	VAC MOTOR, (QBA) 7.2",DB,2 STG, TYPE D P	86855060 / VM-9
TENNANT - CASTEX / NOBLES	35240	36 VOLT 3 STAGE VAC MOTOR	86854650 / VM-280
TENNANT - CASTEX / NOBLES	35240	36 VOLT 3 STAGE VAC MOTOR	86854650 / VM-280

Visit our website for the most current and complete OEM interchange



OEM	OEM Part #	Material Description	Graco Part # / Old Graco#
TENNANT - CASTEX / NOBLES	35323	BRUSH, SWP,50"24SR, NYLON SPIRAL	88054670
TENNANT - CASTEX / NOBLES	35324	BRUSH, SWP,50" DR, POLY/WIRE SPIRAL	88054680
TENNANT - CASTEX / NOBLES	35325	BRUSH, SWP, 50L, 8DR, POLY SPIRAL	88054690
TENNANT - CASTEX / NOBLES	35326	BRUSH,SWEEP,50",8DR, POLYP SPIRAL	88057860
TENNANT - CASTEX / NOBLES	35327	BRUSH, SWP, 50L, 8DR, WIRE SPIRAL	88054700
TENNANT - CASTEX / NOBLES	38002	SWITCH, TOGGLE	86606630 / EA-3
TENNANT - CASTEX / NOBLES	38373	SWITCH,KEY 56441538	86612660 / EAL-1
TENNANT - CASTEX / NOBLES	44296	SOLENOID 36V.56395452,	86606490 / EC-43
TENNANT - CASTEX / NOBLES	44847	SWITCH N.C./N.O.(PRES.)	86652610 / EA-31
TENNANT - CASTEX / NOBLES	45076	VAC MOTOR	86623200 / VM-42
TENNANT - CASTEX / NOBLES	45405	Relay 36VDC 100AMP HVY DUTY	86006370 / EA-80
TENNANT - CASTEX / NOBLES	47153	Vacuum motor complete 24V C17/20 SVC	86005400 / VM-43
TENNANT - CASTEX / NOBLES	49800	LATCH, BRUSH COVER 56462316	86609100 / N-L-2
TENNANT - CASTEX / NOBLES	51542	Brush,Side Swp 26" Dia.Flatwire	88054710
TENNANT - CASTEX / NOBLES	53020	120V,12.7 AMP,2 STAGE VACUUM MTR. (QBA)	86854410 / VM-12
TENNANT - CASTEX / NOBLES	53021	3 STAGE VAC MTR (QBA) (116103-00,117507-	86854460 / VM-14
TENNANT - CASTEX / NOBLES	53042	120V,12.7 AMP,2 STAGE VACUUM MTR. (QBA)	86854410 / VM-12
TENNANT - CASTEX / NOBLES	53130	VAC MOTOR	86854580 / VM-25
TENNANT - CASTEX / NOBLES	53142	120 VOLT 3 STAGE VAC MOTOR	86854760 / VM-33
TENNANT - CASTEX / NOBLES	53152	24 VOLT 2 STAGE VAC MOTOR	86854670 / VM-29
TENNANT - CASTEX / NOBLES	53198	Vacuum motor complete 24V C17/20 SVC	86005400 / VM-43
TENNANT - CASTEX / NOBLES	53230	VAC MOTOR ASM, 115V 4.8 2ST PD	86026750 / VM-46
TENNANT - CASTEX / NOBLES	53614	120 VOLT VAC MOTOR	86854990 / VM-6
TENNANT - CASTEX / NOBLES	53704	120 VOLT 3 STAGE VAC MOTOR	86854760 / VM-33
TENNANT - CASTEX / NOBLES	53707	120 VOLT 3 STAGE VAC MOTOR	86854740 / VM-31
TENNANT - CASTEX / NOBLES	53755	Vacuum motor complete 24V C17/20 SVC	86005400 / VM-43
TENNANT - CASTEX / NOBLES	53772	24 VOLT 3 STAGE VAC MOTOR	86854550 / VM-23
TENNANT - CASTEX / NOBLES	54922	BRUSH,SWEEP 45"-24SR,NYLON	88054720
TENNANT - CASTEX / NOBLES	54923	BRUSH,SWEEP 45"-8DR,NYLON	88054730
TENNANT - CASTEX / NOBLES	54925	BRUSH,SWP 45"8DR, POLY/WIRE, SPIRAL	88054740
TENNANT - CASTEX / NOBLES	54927	BRUSH,SWEEP 45"24SR FIBER/WIRE	88054750
TENNANT - CASTEX / NOBLES	56367	BLADE, NEO (QBA) 2-7/8"x1/8"x47-1/4" -15	86851880 / T-525-7C
TENNANT - CASTEX / NOBLES	59431	BRUSH, SIDE SWEEP,23"DIA,POLY	88054760
TENNANT - CASTEX / NOBLES	59432	BRUSH, SIDE SWEEP,23"DIA, FLATWIRE	88054770
TENNANT - CASTEX / NOBLES	59440	BRUSH,SWEEP, 45"8DR WIRE, SPIRAL	88054780
TENNANT - CASTEX / NOBLES	59610	BLADE, NEO (QBA) 2"x1/4"x27-1/2" -4 Hole	86851900 / T-525-7E
TENNANT - CASTEX / NOBLES	59617	BLADE, PLASTIC 2-1/2"x4" (QBA) - 2 Holes	86852050 / T-550-6D
TENNANT - CASTEX / NOBLES	59775	BLADE, NEO (QBA) 2-1/2"x1/8"x49-1/4" -18	86851940 / T-527-4C
TENNANT - CASTEX / NOBLES	59776	BLADE, GUM (QBA) 5"x3/8"x48-5/8" -9 Hole	86851920 / T-527-4A
TENNANT - CASTEX / NOBLES	60015	BLADE, SIDE RED 35.75" LONG	88058700
TENNANT - CASTEX / NOBLES	60016	BLADE, RED REAR 68.30" LONG	88058710
TENNANT - CASTEX / NOBLES	60018	BLADE, RED FRONT 64" LONG	88058720
TENNANT - CASTEX / NOBLES	61297	FAN	86801210
TENNANT - CASTEX / NOBLES	61300	STATIONARY FAN	86801140
TENNANT - CASTEX / NOBLES	61594	INNER TUBE -4.10-3.50X5	86601010 / WTN-2
TENNANT - CASTEX / NOBLES	61596	TIRE-NON-MARKING	86720400
TENNANT - CASTEX / NOBLES	61597	TIRE & RIM ASSY	86642750 / WTN-8
TENNANT - CASTEX / NOBLES	61598	TIRE ASSY,GRAY HD FOAM,410/3.5-6 3.5BC	98486050 / WTN-7
TENNANT - CASTEX / NOBLES	63035	BLADE, GUM (QBA) 3-1/2"x1/4"x40-3/8" -9	86851820 / T-432-3A
TENNANT - CASTEX / NOBLES	63036	BLADE, NEO (QBA) 2"x1/8"x39-1/2" -9 Hls	86851840 / T-432-3C

Visit our website for the most current and complete OEM interchange



OEM	OEM Part #	Material Description	Graco Part # / Old Graco#
TENNANT - CASTEX / NOBLES	63037	BLADE, GUM (QBA) 2-1/4"x1/8"x39-1/4" -8	86851830 / T-432-3B
TENNANT - CASTEX / NOBLES	63223	SWITCH 47318A	86634570 / ETN-12
TENNANT - CASTEX / NOBLES	63224	SWITCH 47318A	86634570 / ETN-12
TENNANT - CASTEX / NOBLES	63230	36V 2 STAGE VAC MTR (QBA) (116156-00)	86854510 / VM-2
TENNANT - CASTEX / NOBLES	63266	SWITCH **DISCONTINUED**	86622070 / ETN-9
TENNANT - CASTEX / NOBLES	63291	SOLENOID 36v 41802A - etn16	86620760 / ETN-16
TENNANT - CASTEX / NOBLES	63312	5" POLY SWIVEL CASTER(F) (QBA)	86606110 / WC-3
TENNANT - CASTEX / NOBLES	63735	BATTERY CABLE	86827840 / BCS614
TENNANT - CASTEX / NOBLES	63740	BATTERY CABLE	86827840 / BCS614
TENNANT - CASTEX / NOBLES	63967	BLADE, GUM (QBA) 2-1/4"x1/8"x39-1/4" -8	86851830 / T-432-3B
TENNANT - CASTEX / NOBLES	64818	BLADE, GUM (QBA) 3"x1/4"x46-1/2" -8 Hole	86851930 / T-527-4B
TENNANT - CASTEX / NOBLES	65548	5" POLY SWIVEL CASTER(F) (QBA)	86606110 / WC-3
TENNANT - CASTEX / NOBLES	65690	5" POLY SWIVEL CASTER(F) (QBA)	86606110 / WC-3
TENNANT - CASTEX / NOBLES	66019	BRUSH,SWEEP 45"-8DR,POLY SPIRAL	88054790
TENNANT - CASTEX / NOBLES	70538	BRUSH, SIDE SWEEP, 26"POLY	88054800
TENNANT - CASTEX / NOBLES	71170	BRUSH,SCRUB,45" 24SR,POLY,SPIRAL	88054810
TENNANT - CASTEX / NOBLES	71171	BRUSH, SCRUB,45" 24SR,NYLON,SPIRAL	88054820
TENNANT - CASTEX / NOBLES	71200	SKIRT,CI NEO.10.6" LONG	88058730
TENNANT - CASTEX / NOBLES	71255	BLADE, RED FRONT 59" LONG	88058740
TENNANT - CASTEX / NOBLES	71256	BLADE, RED REAR 62.30" LONG	88058750
TENNANT - CASTEX / NOBLES	71612	BRUSH, SCRUB,45" 24SR,GRIT,SPIRAL	88054830
TENNANT - CASTEX / NOBLES	72934	BLADE ASSY, SQGE, SIDE	88060800
TENNANT - CASTEX / NOBLES	75799	STRIP, BACK-UP, 35" LONG	88058770
TENNANT - CASTEX / NOBLES	76065	50A.PLUG (RED)911185	86634110 / CHP-2-R
TENNANT - CASTEX / NOBLES	76932	BLADE, TAN GUM (QBA) 5"x3/8"x68-1/8" -12	86852020 / T-550-6A
TENNANT - CASTEX / NOBLES	76933	BLADE, TAN GUM (QBA) 3"x-1/4"63-3/4" -10	86852030 / T-550-6B
TENNANT - CASTEX / NOBLES	76937	STRIP, BACK-UP, 3.5" WIDE	88058780
TENNANT - CASTEX / NOBLES	78572	TIRE & RIM ASSY	86642750 / WTN-8
TENNANT - CASTEX / NOBLES	80042	BRUSH, SIDE SWEEP,16.5" POLY	88054840
TENNANT - CASTEX / NOBLES	81888	BRUSH, SWEEP,22" POLY SPIRAL	88054850
TENNANT - CASTEX / NOBLES	83030	BRUSH, SWEEP,22" WEDGE, POLY SPIRAL	88054860
TENNANT - CASTEX / NOBLES	83031	BRUSH, SWEEP,22" 8SR,UNION MIX SPIRAL	88054870
TENNANT - CASTEX / NOBLES	83809	BLADE, RED FRONT 68.82" LONG	88058790
TENNANT - CASTEX / NOBLES	83810	BLADE, RED REAR 72.75" LONG	88058800
TENNANT - CASTEX / NOBLES	86812	GASKET, SQUEEGEE	88058810
TENNANT - CASTEX / NOBLES	86859	SQUEEGEE ASSY, SIDE RED	88060810
TENNANT - CASTEX / NOBLES	87097	BRUSH,SWEEP,36" POLY/WIRE	88054880
TENNANT - CASTEX / NOBLES	87099	BRUSH,SWEEP,36" POLY	88054890
TENNANT - CASTEX / NOBLES	87419	BRUSH, DISK, SWEEP, 19",POLY	88057870
TENNANT - CASTEX / NOBLES	89031	BLADE, TAN GUM (QBA) 4"x3/16"x40" -10 Ho	86851760 / T-426-6A
TENNANT - CASTEX / NOBLES	89034	BLADE, TAN GUM (QBA)2-3/4"x1/8"x36-7/8"	86851770 / T-426-6B
TENNANT - CASTEX / NOBLES	89035	BLADE, NEO BACKUP (QBA) 3"x1/8"x39"-10 H	86851780 / T-426-6C
TENNANT - CASTEX / NOBLES	89077	STRAINER, ROUND 5/8" OPENING	86606580 / FC-2
TENNANT - CASTEX / NOBLES	100001	GASKET,VAC MOTOR	86602290 / TN-G-7
TENNANT - CASTEX / NOBLES	100038	GASKET, 20/24 VAC MOTOR	86003870 / TN-G-6
TENNANT - CASTEX / NOBLES	100042	GASKET	86658510 / CX-G-3
TENNANT - CASTEX / NOBLES	100101	LOCK, PAD DRIVER BLUE	86246740 / PH-6
TENNANT - CASTEX / NOBLES	100105	LID-VAC (S-2001)100105	86602300 / N-L-1
TENNANT - CASTEX / NOBLES	100107	PAD HOLDER-CLIP 56182058	86633840 / PH-3-P
TENNANT - CASTEX / NOBLES	100117	GASKET	86602230 / CX-G-1

Visit our website for the most current and complete OEM interchange



OEM	OEM Part #	Material Description	Graco Part # / Old Graco#
TENNANT - CASTEX / NOBLES	100118	GASKET	86602610 / CX-G-2
TENNANT - CASTEX / NOBLES	100122	GASKET VAC MOTOR	86832880 / CX-G-4
TENNANT - CASTEX / NOBLES	100150	GASKET, SQG .13 THK X 8.00 LG	86003980 / N-G-4
TENNANT - CASTEX / NOBLES	100151	GASKET / N-G-2	86602170 / N-G-2
TENNANT - CASTEX / NOBLES	100180	CIRCUIT BREAKER-60 AMP	86608900 / EA-71
TENNANT - CASTEX / NOBLES	101714	VAC GASKET	86602200 / N-G-3
TENNANT - CASTEX / NOBLES	102550	FOAM FILTER OEM # 102550	86839890 / FNB-2
TENNANT - CASTEX / NOBLES	102556	GASKET	86602420
TENNANT - CASTEX / NOBLES	103001	3" CASTER ASSY.	86601880 / WN-2
TENNANT - CASTEX / NOBLES	103002	CASTER, 4DIA X 2 W X 3.56 R	86002310 / WN-1
TENNANT - CASTEX / NOBLES	103035	5" POLY SWIVEL CASTER(F) (QBA)	86606110 / WC-3
TENNANT - CASTEX / NOBLES	103051	4"CASTER WHEEL W/STEM (QBA) (F)	86608480 / WC-4
TENNANT - CASTEX / NOBLES	103055	WHEEL	86726670 / WN-3
TENNANT - CASTEX / NOBLES	103058	WHEEL, 8" DRIVE SCRUBBER	86724960
TENNANT - CASTEX / NOBLES	130015	METER 24V.	86602500 / ENM-1
TENNANT - CASTEX / NOBLES	130130	TERMINAL 100/PK	86835070 / EW-17
TENNANT - CASTEX / NOBLES	130155	S.B. PLUG 50A grey 911185	86634080 / CHP-2
TENNANT - CASTEX / NOBLES	130214	CORD 75' 14/3 YELLOW ST 600V	86695500 / E-4752Y
TENNANT - CASTEX / NOBLES	130217	SOLENOID 36V.6POLE 788147	86607790 / EC-81
TENNANT - CASTEX / NOBLES	130218	SOLENOID 24 VOLT 878514,788147	86606480 / EC-1
TENNANT - CASTEX / NOBLES	130229	CORD 75' 14/3 YELLOW ST 600V	86695500 / E-4752Y
TENNANT - CASTEX / NOBLES	130252	POWER CORD	86652930 / E-40Y
TENNANT - CASTEX / NOBLES	130304	RECTIFIER, 15A	86602840 / EN-3
TENNANT - CASTEX / NOBLES	130367	BATTERY CABLE	86827890 / BCSN415
TENNANT - CASTEX / NOBLES	130369	BATTERY CABLE	86827730 / BC436B
TENNANT - CASTEX / NOBLES	130370	BATTERY CABLE	86827720 / BC425R
TENNANT - CASTEX / NOBLES	130397	Vacuum motor complete 24V C17/20 SVC	86005400 / VM-43
TENNANT - CASTEX / NOBLES	130400	120V,12.7 AMP,2 STAGE VACUUM MTR. (QBA)	86854410 / VM-12
TENNANT - CASTEX / NOBLES	130402	120 VOLT 2 STAGE VAC MOTOR (VM-13)	86854420 / VM-13
TENNANT - CASTEX / NOBLES	130404	3 STAGE VAC MTR (QBA) (116103-00,117507-	86854460 / VM-14
TENNANT - CASTEX / NOBLES	130406	VAC MOTOR	86634760 / VM-54
TENNANT - CASTEX / NOBLES	130415	120 VOLT 2 STAGE VAC MOTOR (VM-13)	86854420 / VM-13
TENNANT - CASTEX / NOBLES	130416	VAC MOTOR	86854580 / VM-25
TENNANT - CASTEX / NOBLES	130417	VAC MOTOR, 120V 5.7 3ST LP	86258450 / VM-33A+
TENNANT - CASTEX / NOBLES	130418	120 VOLT 2 STAGE VAC MOTOR	86854820 / VM-4
TENNANT - CASTEX / NOBLES	130457	VAC MOTOR ASM, 115V 4.8 2ST PD	86026750 / VM-46
TENNANT - CASTEX / NOBLES	130464	MOTOR, DRIVE 1/2 HP 1500RPM 24V *	86844140 / MTN-1
TENNANT - CASTEX / NOBLES	130465	DRIVE COUPLER	86637400 / BLC-40
TENNANT - CASTEX / NOBLES	130477	24 VOLT 3 STAGE VAC MOTOR	86854550 / VM-23
TENNANT - CASTEX / NOBLES	130491	MOTOR/GEAR UNIT	86844120 / MTC-5
TENNANT - CASTEX / NOBLES	130647	SWITCH	86619960 / EA-5
TENNANT - CASTEX / NOBLES	130677	SWITCH, ROCKER	86619990 / EA-37
TENNANT - CASTEX / NOBLES	130684	SWITCH, TOGGLE	86603130 / EN-2
TENNANT - CASTEX / NOBLES	130701	SWITCH, TOGGLE	86606630 / EA-3
TENNANT - CASTEX / NOBLES	130717	SWITCH EMERGENCY - ECX-1	86616050 / ECX-1
TENNANT - CASTEX / NOBLES	130726	SWITCH	86634650 / EN-1
TENNANT - CASTEX / NOBLES	130729	SWITCH EA-14	86616090 / EA-14
TENNANT - CASTEX / NOBLES	130733	SOLENOID 36V.56395452,	86606490 / EC-43
TENNANT - CASTEX / NOBLES	130737	10 AMP BREAKER	86608930 / EA-72
TENNANT - CASTEX / NOBLES	130740	POTENTIOMETER 740804	86634400 / DSC-2

Visit our website for the most current and complete OEM interchange



OEM	OEM Part #	Material Description	Graco Part # / Old Graco#
TENNANT - CASTEX / NOBLES	130743	CIRCUIT BREAKER 1.5 (QBA)	86608270 / EA-16
TENNANT - CASTEX / NOBLES	130755	10 AMP BREAKER	86608930 / EA-72
TENNANT - CASTEX / NOBLES	130756	CIRCUIT BREAKER 35AMP (QBA)	86608910 / EA-35
TENNANT - CASTEX / NOBLES	130760	CIRCUIT BREAKER 1.5 (QBA)	86608270 / EA-16
TENNANT - CASTEX / NOBLES	130764	SWITCH,ROCKER W/CAP	86602950 / EN-4
TENNANT - CASTEX / NOBLES	130787	SWITCH,ROCKER,SPST-MOM	86899400
TENNANT - CASTEX / NOBLES	130816	SWITCH,ILLUM.ROCKER	86602960 / EN-5
TENNANT - CASTEX / NOBLES	130948	CHARGER 24V. 20AMP	86832000 / CH-2450G
TENNANT - CASTEX / NOBLES	130956	FUSE HOLDER FRONT	86609740 / CPT-1374
TENNANT - CASTEX / NOBLES	130957	FUSE	86609530 / CPT-7996
TENNANT - CASTEX / NOBLES	130983	RECTIFIER 50A.	86637330 / EC-61
TENNANT - CASTEX / NOBLES	130987	CHARGER 24V. 20AMP	86832000 / CH-2450G
TENNANT - CASTEX / NOBLES	130988	120 VOLT VAC MOTOR	86854990 / VM-6
TENNANT - CASTEX / NOBLES	130995	24V VAC MOTOR (QBA) (116155-00)	86601190 / VM-1
TENNANT - CASTEX / NOBLES	130996	VAC MOTOR	86854580 / VM-25
TENNANT - CASTEX / NOBLES	140015	WASHER, LOCK, SPLT, 5/16	86860940
TENNANT - CASTEX / NOBLES	140124	BEARING, BALL (6205-2RS)	86626370 / MC-1-B
TENNANT - CASTEX / NOBLES	140125	BEARING/BALL	86608810 / AD-B-1
TENNANT - CASTEX / NOBLES	140932	LATCH, BRUSH COVER 56462316	86609100 / N-L-2
TENNANT - CASTEX / NOBLES	160406	(k) HOSE VAC 2x20.5 W/CUFF	98481630 / VHN-3
TENNANT - CASTEX / NOBLES	160430	WIRE HOSE CUFF1-1/2,1-1/2W (QBA)	86609780 / HC-7
TENNANT - CASTEX / NOBLES	160617	(K) HOSE VAC 1.5" X 24" W/ CUFFS	98482180 / VHN-2
TENNANT - CASTEX / NOBLES	180103	SHURFLO PUMP	86717350 / M-104
TENNANT - CASTEX / NOBLES	180120	PUMP-LITTLE GIANT (QBA)	86842540 / M-20
TENNANT - CASTEX / NOBLES	180121	PUMP-LITTLE GIANT (QBA)	86842540 / M-20
TENNANT - CASTEX / NOBLES	180124	PUMP-LITTLE GIANT (QBA)	86842540 / M-20
TENNANT - CASTEX / NOBLES	180134	PUMP-LITTLE GIANT (QBA)	86842540 / M-20
TENNANT - CASTEX / NOBLES	180613	FLOAT SCREEN CAGE ASSY	86199840 / FNB-1
TENNANT - CASTEX / NOBLES	180626	Filter VAC MOTOR	86003510 / FA-1
TENNANT - CASTEX / NOBLES	180628	STRAINER, ROUND 5/8" OPENING	86606580 / FC-2
TENNANT - CASTEX / NOBLES	180641	STRAINER, ROUND 5/8" OPENING	86606580 / FC-2
TENNANT - CASTEX / NOBLES	190129	PRESSURE SWITCH KIT	86842380 / M-104-PS
TENNANT - CASTEX / NOBLES	190753	RECTIFIER 60A/600V *EN-6*	86666760 / EN-6
TENNANT - CASTEX / NOBLES	200823	GRIP-HANDLE 290-1138	86608610 / GRA-2000
TENNANT - CASTEX / NOBLES	210231	DRAIN VALVE	86634390 / VC-72
TENNANT - CASTEX / NOBLES	210232	ELBOW 2" VALVE (1019-2)	86852900 / VC-72-E
TENNANT - CASTEX / NOBLES	210242	DRAIN VALVE	86634390 / VC-72
TENNANT - CASTEX / NOBLES	210259	SOLUTION VALVE - VNS-1	86609670 / VNS-1
TENNANT - CASTEX / NOBLES	210261	SOLUTION VALVE - VNS-1	86609670 / VNS-1
TENNANT - CASTEX / NOBLES	220200	KNOB	86644520 / VCP-10
TENNANT - CASTEX / NOBLES	222066	BUMPER WHEEL	86618540 / WA-10
TENNANT - CASTEX / NOBLES	222113	(k) VALVE, SOLENOID 36V 5700	98481230 / VTN-4
TENNANT - CASTEX / NOBLES	222114	METER, HOUR	86619490 / EA-83
TENNANT - CASTEX / NOBLES	222116	SWITCH	86622060 / ETN-20
TENNANT - CASTEX / NOBLES	222120	GASKET-TANK,FRONT	86621340 / TN-G-5
TENNANT - CASTEX / NOBLES	222121	GASKET TANK REAR	86852480 / TN-G-8
TENNANT - CASTEX / NOBLES	222128	GASKET, 20/24 VAC MOTOR	86003870 / TN-G-6
TENNANT - CASTEX / NOBLES	222216	METER-BATT.COND. 56448677	86608640 / EAM-3
TENNANT - CASTEX / NOBLES	222217	CABLE ASSY, W/50A GRAY PLUG	98486190
TENNANT - CASTEX / NOBLES	222241	BLADE, RED 2"x1/8"x43" -15 Hls/Ntchs	86897890 / T-5732-2B

Visit our website for the most current and complete OEM interchange



OEM	OEM Part #	Material Description	Graco Part # / Old Graco#
TENNANT - CASTEX / NOBLES	222242	BLADE, RED 2"x-1/4"x45-1/2" -15 Holes	86897880 / T-5732-2A
TENNANT - CASTEX / NOBLES	222255	MOTOR 1 HP W/GEARBOX,45036B	86609160 / F755401
TENNANT - CASTEX / NOBLES	222304	BRUSH, SCRUB, 28"18SR, POLY SPIRAL	88054900
TENNANT - CASTEX / NOBLES	222305	BRUSH, SCRUB, 28"18SR, NYLON SPIRAL	88054910
TENNANT - CASTEX / NOBLES	222306	BRUSH, SCRUB, 28"18SR, GRIT SPIRAL	88054920
TENNANT - CASTEX / NOBLES	222307	BRUSH, SCRUB,32"18SR,STIFF POLY SPIRAL	88054930
TENNANT - CASTEX / NOBLES	222308	BRUSH, SCRUB,32"18SR,NYLON SPIRAL	88054940
TENNANT - CASTEX / NOBLES	222309	BRUSH, SCRUB,32"18SR,GRIT SPIRAL	88054950
TENNANT - CASTEX / NOBLES	222310	BRUSH, SCRUB,36"18SR, POLY SPIRAL	88054960
TENNANT - CASTEX / NOBLES	222311	BRUSH, SCRUB,36"18SR,NYLON SPIRAL	88054970
TENNANT - CASTEX / NOBLES	222312	BRUSH, SCRUB,36"18SR,GRIT SPIRAL	88054980
TENNANT - CASTEX / NOBLES	222320	BRUSH ASSY, DISK,14" POLY	88054990
TENNANT - CASTEX / NOBLES	222321	BRUSH ASSY, DISK,14" NYLON	88055000
TENNANT - CASTEX / NOBLES	222322	BRUSH ASSY, DISK,14".060 GRIT	88055010
TENNANT - CASTEX / NOBLES	222323	PAD DRIVER ASSY. 14"	88055080
TENNANT - CASTEX / NOBLES	222379	DRAIN HOSE ASSY W/CAP	86621470 / VHTN-8
TENNANT - CASTEX / NOBLES	222381	BLADE, RED 2"x1/8"x38-3/4" -13 Hls/5 Ntc	86897870 / T-5728-2B
TENNANT - CASTEX / NOBLES	222382	BLADE, RED 2"x1/4"x41"-13 Holes (rear)	86897860 / T-5728-2A
TENNANT - CASTEX / NOBLES	222383	STRAP - TS-2	86622050 / TS-2
TENNANT - CASTEX / NOBLES	222384	BLADE SQUEEGEE, GUM 32" FRONT	86898050
TENNANT - CASTEX / NOBLES	222385	BLADE SQUEEGEE, GUM 28" FRONT	88051380 / T-5732-2GA
TENNANT - CASTEX / NOBLES	222386	BLADE SQUEEGEE, GUM 32" FRONT	86898030
TENNANT - CASTEX / NOBLES	222387	BLADE SQUEEGEE, GUM 28" REAR	86898020
TENNANT - CASTEX / NOBLES	222403	BUMPER WHEEL 2 x 7/8"	86602150 / WTN-6
TENNANT - CASTEX / NOBLES	222413	SQUEEGEE 36 FRONT	86622000 / T-5736-2B
TENNANT - CASTEX / NOBLES	222414	BLADE SQUEEGEE, GUM 36" FRONT	86898040
TENNANT - CASTEX / NOBLES	222415	BLADE, SQGE, REAR, 49.37L RED (900MM)	86622010 / T-5736-2A
TENNANT - CASTEX / NOBLES	222416	BLADE, SQGE, REAR, 49.37L GUM [36"]	86683370
TENNANT - CASTEX / NOBLES	222423	SQUEEGEE BLADE SET, GUM 32" (800 SERIES)	98486770
TENNANT - CASTEX / NOBLES	222424	SQUEEGEE SET 36" (QBA)	98485170 / T-5736-2
TENNANT - CASTEX / NOBLES	222458	5" POLY SWIVEL CASTER(F) (QBA)	86606110 / WC-3
TENNANT - CASTEX / NOBLES	222517	STRAP - TS-4	86622040 / TS-4
TENNANT - CASTEX / NOBLES	222648	GRIP-HANDLE 290-1138	86608610 / GRA-2000
TENNANT - CASTEX / NOBLES	222788	HOSE SOLUTION DRAIN W/DRAIN CAP	86621490 / VHTN-7
TENNANT - CASTEX / NOBLES	222806	MOTOR-BRUSH 45037A	86606340 / MTC-2
TENNANT - CASTEX / NOBLES	222822	FLOAT ASSM 222822	86665960 / FTN-3
TENNANT - CASTEX / NOBLES	222831	DRAIN PLUG 1 1/2"621324	86601910 / VTN-1
TENNANT - CASTEX / NOBLES	222832	DRAIN PLUG 1" - VTN-3	86621230 / VTN-3
TENNANT - CASTEX / NOBLES	223264	GASKET, 20/24 VAC MOTOR	86003870 / TN-G-6
TENNANT - CASTEX / NOBLES	223606	Blade, SQ, Front, 3/16 Red, 47.41L (900MM)	88053690
TENNANT - CASTEX / NOBLES	230205	SHAFT, DRIVE WHEEL	86669090
TENNANT - CASTEX / NOBLES	230794	SCREEN	86603090 / FNB-3
TENNANT - CASTEX / NOBLES	240021	40 LINK,CONN.	86633920 / BLAL-9
TENNANT - CASTEX / NOBLES	240070	Sprocket,40A39 x 1.75" Bore	86885050
TENNANT - CASTEX / NOBLES	240071	SPROCKET,1/4" KEYWAY, 3/4"10 tooth	86857110 / BLT-3
TENNANT - CASTEX / NOBLES	240217	KNOB	86669480
TENNANT - CASTEX / NOBLES	240221	BLADE, NEO (QBA) 1-1/4"x1/16"x32-1/2" -1	86844550 / N-2700-2B
TENNANT - CASTEX / NOBLES	240223	BLADE, GUM (QBA) 1-1/2"x3/16"x35" -12 Ho	86844540 / N-2700-2A
TENNANT - CASTEX / NOBLES	240233	PAD DRIVER 16"	88056940 / BRN-33-AG
TENNANT - CASTEX / NOBLES	240238	BRUSH LOCK STUD	86618480 / L-800

Visit our website for the most current and complete OEM interchange



OEM	OEM Part #	Material Description	Graco Part # / Old Graco#
TENNANT - CASTEX / NOBLES	240271	SPLASH GUARD	86685910 / N-2400-S
TENNANT - CASTEX / NOBLES	240276	SPLASHGUARD	86602970 / N-3301-S
TENNANT - CASTEX / NOBLES	240277	SPLASH GUARD	86602990 / N-2701-S
TENNANT - CASTEX / NOBLES	240292	BLADE, URETHANE (QBA) 1-5/16"x1/8"x40-3/	86844750 / N-33-4A
TENNANT - CASTEX / NOBLES	240293	BLADE, URETHANE SERRATED 1-3/8"x1/8"x40-3	86844760 / N-33-4B
TENNANT - CASTEX / NOBLES	240294	BLADE, URETHANE (QBA) W-3/8"x1/8"x34-3/4	86844620 / N-27-4A
TENNANT - CASTEX / NOBLES	240295	BLADE, URETHANE SERRATED 1-3/8"x1/8"x34-3	86844630 / N-27-4B
TENNANT - CASTEX / NOBLES	240296	BLADE, URETHANE (QBA) 1-1/2"x1/8"x25" -	86844300 / N-1701-4A
TENNANT - CASTEX / NOBLES	240297	BLADE, URETHANE SERRATED (QBA) 1-1/2"x1/	86844310 / N-1701-4B
TENNANT - CASTEX / NOBLES	240298	BLADE, URETHANE (QBA) 1-7/16"x3/32"x27-3	86844380 / N-2001-4A
TENNANT - CASTEX / NOBLES	240299	BLADE,URETHANE SERRATED(QBA)1-3/8"x3/32"	86844390 / N-2001-4B
TENNANT - CASTEX / NOBLES	240301	BLADE, NEO (QBA) 1-1/8"x1/16"x25-1/2" -9	86844280 / N-1700-2B
TENNANT - CASTEX / NOBLES	240302	BLADE, NEO (QBA) 1-1/4"x1/16"x22-1/4" -	86844360 / N-2000-2B
TENNANT - CASTEX / NOBLES	240303	BLADE, GUM 1-3/8"x3/16"x28" (QBA) - 9 Ho	86844270 / N-1700-2A
TENNANT - CASTEX / NOBLES	240304	BLADE, GUM (QBA) 1-5/8"x3/16"x25" - 9 Ho	86844350 / N-2000-2A
TENNANT - CASTEX / NOBLES	363123	BLADE ASSY, SQGE, SIDE	88060820
TENNANT - CASTEX / NOBLES	365322	BLADE, RED FRONT 56.68" LONG	88058850
TENNANT - CASTEX / NOBLES	365323	BLADE, RED REAR 64.13" LONG	88058860
TENNANT - CASTEX / NOBLES	370008	BRUSH, SWEEP,45", WEDGE, POLY SPIRAL	88055020
TENNANT - CASTEX / NOBLES	370095	Lock PAD CENTER SNAP,TWO STEP	86005070 / PH-8
TENNANT - CASTEX / NOBLES	370100	KNOB	86856920 / SNT-1
TENNANT - CASTEX / NOBLES	370113	FILTER VAC 5700/5680	86665940 / FTN-4
TENNANT - CASTEX / NOBLES	374002	MOTOR-BRUSH 45037A	86606340 / MTC-2
TENNANT - CASTEX / NOBLES	374005	GEAR BOX 54238A	86609030 / BLC-24
TENNANT - CASTEX / NOBLES	374014	CHARGER 36V 20A (50A GRAY)	98483530 / CH-6350G
TENNANT - CASTEX / NOBLES	374042	BRUSH, SCRUB,32"18SR, MED.POLY SPIRAL	88055030
TENNANT - CASTEX / NOBLES	374043	BRUSH, SCRUB,36"18SR, POLY SPIRAL	88055040
TENNANT - CASTEX / NOBLES	374044	TIRE ASSY,GRAY HD FOAM,410/3.5-6 3.5BC	98486050 / WTN-7
TENNANT - CASTEX / NOBLES	374059	DRAIN HOSE ASSY W/CAP	86621470 / WHTN-8
TENNANT - CASTEX / NOBLES	374111	DRAIN PLUG 1" - VTN-3	86621230 / VTN-3
TENNANT - CASTEX / NOBLES	374752	(k) VALVE, WATER SOL 36VDC (QBA)	98481410 / VTN-5
TENNANT - CASTEX / NOBLES	377433	HOUR METER - 12-60VDC ANALOG	86636010 / EC-93
TENNANT - CASTEX / NOBLES	377440	MOTOR-BRUSH 45037A	86606340 / MTC-2
TENNANT - CASTEX / NOBLES	381918	TIRE ASSY,GRAY HD FOAM,410/3.5-6 3.5BC	98486050 / WTN-7
TENNANT - CASTEX / NOBLES	383487	BRUSH,SWEEP, POLY SPIRAL	88055050
TENNANT - CASTEX / NOBLES	383993	BRUSH,SWEEP, NATURAL FIBER	88055060
TENNANT - CASTEX / NOBLES	386260	BLADE ASSY, SQGE, 28.6L	88060840
TENNANT - CASTEX / NOBLES	386283	BLADE, RED FRONT 49" LONG	88058880
TENNANT - CASTEX / NOBLES	386284	BLADE, RED REAR 51.38" LONG	88058890
TENNANT - CASTEX / NOBLES	386326	FILTER, VAC FAN	86785820
TENNANT - CASTEX / NOBLES	386387	SKIRT,CI NEO.47.19" LONG	88058900
TENNANT - CASTEX / NOBLES	386388	SKIRT,CI NEO.15.66" LONG	88058910
TENNANT - CASTEX / NOBLES	390734	BLADE SQUEEGEE,GUM REAR 32"(44"L)	88050840
TENNANT - CASTEX / NOBLES	390922	BLADE SQUEEGEE,RED REAR 32"(44"L)	88050020
TENNANT - CASTEX / NOBLES	390923	BLADE SQUEEGEE, RED FRONT 32" (41.5"L)	88050030
TENNANT - CASTEX / NOBLES	390936	BLADE, REAR GUM (QBA) (OPTIONAL)	86852180 / T-7128-2C
TENNANT - CASTEX / NOBLES	390942	REAR BLADE	86688740 / T-7128-2A
TENNANT - CASTEX / NOBLES	390943	SQUEEGEE BLADE	86688750 / T-7128-2B
TENNANT - CASTEX / NOBLES	391296	36 VOLT 3 STAGE VAC MOTOR	86854650 / VM-280
TENNANT - CASTEX / NOBLES	392842	BLADE, LH SIDE 21.41"LONG	88058920

Visit our website for the most current and complete OEM interchange



OEM	OEM Part #	Material Description	Graco Part # / Old Graco#
TENNANT - CASTEX / NOBLES	397776	SCREW - PLUG	86601960
TENNANT - CASTEX / NOBLES	397779	Washer, Splash Skirt (.28 1.00db .06t Steel Black Zinc)	86601970
TENNANT - CASTEX / NOBLES	397780	SCREW - PLUG	86601960
TENNANT - CASTEX / NOBLES	397815	MOTOR .75 GEAR 36 VOLT	86838680 / F755400
TENNANT - CASTEX / NOBLES	397832	SKIRT, HEAD, DISK, 32.0/800MM	86602810
TENNANT - CASTEX / NOBLES	397889	SWITCH	86694870 / ETN-22
TENNANT - CASTEX / NOBLES	397916	PAD DRIVER ASSY. 16"	88055320
TENNANT - CASTEX / NOBLES	397918	PAD DRIVER ASSY. 18"	88055330
TENNANT - CASTEX / NOBLES	397976	PAD DRIVER 16"	88055320 / BRT-5732-AG
TENNANT - CASTEX / NOBLES	398205	DRAIN PLUG 1 1/2"621324	86601910 / VTN-1
TENNANT - CASTEX / NOBLES	398520	VAC MOTOR, 36V 3STG (W FEM TERM)	98484280
TENNANT - CASTEX / NOBLES	398850	DRAIN PLUG 1 1/2"621324	86601910 / VTN-1
TENNANT - CASTEX / NOBLES	573082	CORD ASM, 14/3 SJT X 75' YLW	86217150
TENNANT - CASTEX / NOBLES	578064	VALVE	86642210 / VE-1
TENNANT - CASTEX / NOBLES	578441	STRAP	86648970 / TS-3
TENNANT - CASTEX / NOBLES	600157	GASKET, ROUND 1/2 (TYPHOON)	86859550 / TNG10
TENNANT - CASTEX / NOBLES	600158	GASKET, FLOAT 1/4 (TYPHOON)	86859560 / TNG11
TENNANT - CASTEX / NOBLES	600160	GASKET, FLOAT 1/8 (TYPHOON)	86859570 / TNG12
TENNANT - CASTEX / NOBLES	600207	SQUEEGEE BLADE FRT	86701720
TENNANT - CASTEX / NOBLES	600258	24V VAC MOTOR (QBA) (116155-00)	86601190 / VM-1
TENNANT - CASTEX / NOBLES	600294	SPLASHGUARD	86603100 / N-2601-S
TENNANT - CASTEX / NOBLES	600295	SPLASHGUARD (QBA)	86844490 / N-2401-S
TENNANT - CASTEX / NOBLES	600332	WHEEL 4.00 X .968. bore=5/16	86609400 / WA-95
TENNANT - CASTEX / NOBLES	600344	4X2 POLY WHEEL W/BRG(F)	86616310 / WA-1-W
TENNANT - CASTEX / NOBLES	600476	STRAP	86648970 / TS-3
TENNANT - CASTEX / NOBLES	601454	SQUEEGEE	86660820 / N-5100-2B
TENNANT - CASTEX / NOBLES	601455	SQUEEGEE	86660800 / N-5100-2A
TENNANT - CASTEX / NOBLES	601468	(k) VAC MOTOR (VM-29 w/ 1-1/2" TUBE) 458	98482060 / VM-29-B
TENNANT - CASTEX / NOBLES	601485	BLADE, SQGE, (QBA) FRONT 26.38"L RED LIN	86844820 / N-5100R-2B
TENNANT - CASTEX / NOBLES	601486	BLADE, SQGE, (QBA) REAR 26.88"L RED LINA	86844810 / N-5100R-2A
TENNANT - CASTEX / NOBLES	602656	VAC MOTOR	86724040 / VM-47
TENNANT - CASTEX / NOBLES	602748	CORD 75' 14/3 YELLOW ST 600V	86695500 / E-4752Y
TENNANT - CASTEX / NOBLES	603031	PUMP.100PSI-24V	86621720 / M-107
TENNANT - CASTEX / NOBLES	603235	CHARGER 24V. 20A.	86738010 / CH-31
TENNANT - CASTEX / NOBLES	603260	GASKET, SQG .13 THK X 8.00 LG	86003980 / N-G-4
TENNANT - CASTEX / NOBLES	603310	VALVE 24V.	86694410 / VTN-6
TENNANT - CASTEX / NOBLES	603398	MOTOR	86701960 / MTN-2
TENNANT - CASTEX / NOBLES	603487	15A.CIRCUIT BRK.740130	86618740 / EA-34
TENNANT - CASTEX / NOBLES	603538	CENTER PAD HOLDER L.H.56393567	86633810 / PH-6-L
TENNANT - CASTEX / NOBLES	603547	HOSE ASSY. 46" BLACK	98486110
TENNANT - CASTEX / NOBLES	603553	CHARGER 24V 12A AUTO (50A RED)	86600920 / CH-10
TENNANT - CASTEX / NOBLES	603653	PUMP, 110/120 60HZ FLOJET	86201110 / M-108
TENNANT - CASTEX / NOBLES	603659	BLADE SQUEEGEE, 27" 2001 (QBA)	86602870 / N-2001N-2A
TENNANT - CASTEX / NOBLES	603660	SQ. BLADE 2401, 31"	86622020 / N-2401N-2A
TENNANT - CASTEX / NOBLES	603661	BLADE, SQUEEGEE 34" 2701 (QBA)	86603010 / N-2701N-2A
TENNANT - CASTEX / NOBLES	603662	BLADE	86648660 / N-3301N-2A
TENNANT - CASTEX / NOBLES	604390	BLADE, SQUEEGEE 24" 1701 (QBA)	86602580
TENNANT - CASTEX / NOBLES	604815	FAN VACUUM	86657610 / VM-53
TENNANT - CASTEX / NOBLES	604838	BAGS, FILTER (10 PACK) LITE TRAC, VIPER,	86848340 / PBCX-1
TENNANT - CASTEX / NOBLES	605027	SQGE, REAR 36"L GUMRBR (QBA) [5400]	86844910 / N-5400G-2A

Visit our website for the most current and complete OEM interchange



OEM	OEM Part #	Material Description	Graco Part # / Old Graco#
TENNANT - CASTEX / NOBLES	605028	SQGE, FRONT 34"L GUMRBR (QBA) [5400]	86844920 / N-5400G-2B
TENNANT - CASTEX / NOBLES	605029	SQGE, REAR 36"L LINATEX (QBA) [5400]	86844880 / N-5400-2A
TENNANT - CASTEX / NOBLES	605030	SQGE, FRONT 34"L LINATEX (QBA) [5400]	86844890 / N-5400-2B
TENNANT - CASTEX / NOBLES	605197	15A.CIRCUIT BRK.740130	86618740 / EA-34
TENNANT - CASTEX / NOBLES	605357	24 VOLT 2 STAGE VAC MOTOR	86854670 / VM-29
TENNANT - CASTEX / NOBLES	605387	PLUG HOUSING 50A-RED	86634000 / CHP-7-R
TENNANT - CASTEX / NOBLES	605905	SOLENOID 24 VOLT 878514,788147	86606480 / EC-1
TENNANT - CASTEX / NOBLES	605958	SPLASH GUARD	86693190 / N-2001-S
TENNANT - CASTEX / NOBLES	606292	SWITCH	86634620 / EA-32
TENNANT - CASTEX / NOBLES	606426	(k) DRIVE CHAIN BLN-1	98481220 / BLN-1
TENNANT - CASTEX / NOBLES	606682	SQUEEGEE BLADE EACH, (QBA) 40"L, 1/8" GU	86844640 / N-3301-2A
TENNANT - CASTEX / NOBLES	606752	SQGE, SET LINATEX [5400](QBA)	98485180 / N-5400-2
TENNANT - CASTEX / NOBLES	606757	SQGE, SET GUMRBR (QBA) [5400]	98485580 / N-5400G-2
TENNANT - CASTEX / NOBLES	606758	SQGE, SET LINATEX [5400](QBA)	98485180 / N-5400-2
TENNANT - CASTEX / NOBLES	606780	BREAKER, 30A 50VDC CIRCUIT - VAC MOTOR	86001910 / EA-29
TENNANT - CASTEX / NOBLES	606986	3" CASTER ASSY.	86601880 / WN-2
TENNANT - CASTEX / NOBLES	607473	VALVE SOLENOID 24VDC	86601210 / VK-3
TENNANT - CASTEX / NOBLES	608605	SWITCH - VAC WHITE	86622410 / EB-42
TENNANT - CASTEX / NOBLES	609012	(k) HOSE VAC 2x20.5 W/CUFF	98481630 / VHN-3
TENNANT - CASTEX / NOBLES	609055	BLADE, SQGE, (QBA) REAR 40.92"L RED LINA	86844590 / N-2701R-2A
TENNANT - CASTEX / NOBLES	609056	BLADE,SQGE,REAR 40.92"L GUM X-WIDE 3/16"	86859660 / N-2701G-2A
TENNANT - CASTEX / NOBLES	609115	SQUEEGEE SET NOBLES 2701 (QBA)	98485540 / N-2701R-2
TENNANT - CASTEX / NOBLES	609116	SQUEEGEE SET, RIDGED URETHANE, 2701 (QBA)	98484800 / N-2701N-2
TENNANT - CASTEX / NOBLES	610150	SQUEEGEE BLADE-REAR RED 31.8 LONG	88058570
TENNANT - CASTEX / NOBLES	610974	CORD 75' 14/3 YELLOW ST 600V	86695500 / E-4752Y
TENNANT - CASTEX / NOBLES	611005	SWITCH, SNAP, 10A, .25HP	86860730
TENNANT - CASTEX / NOBLES	611006	SWITCH KIT ASSY.	98486210
TENNANT - CASTEX / NOBLES	611402	BLADE, REAR, RED LINATEX (QBA) 45.6" (XR	86844720 / N-3301R-2A
TENNANT - CASTEX / NOBLES	611405	BLADE, REAR, GUM 45.6" (QBA)	86844650 / N-3301G-2A
TENNANT - CASTEX / NOBLES	611780	BAGS, FILTER (10 PACK) PORTAPAC, STRAP-A	86848610 / PBT-3
TENNANT - CASTEX / NOBLES	611783	BAGS, FILTER (10 PACK) LITE TRAC, VIPER,	86848340 / PBCX-1
TENNANT - CASTEX / NOBLES	611784	BAG, FILTER (10 PACK) MAGNA TWIN, S-VAC,	86848360 / PBCX-2
TENNANT - CASTEX / NOBLES	611787	BAGS, FILTER (10 PACK) LITE TRAC, VIPER,	86848340 / PBCX-1
TENNANT - CASTEX / NOBLES	611847	(k) VAC. HOSE ASSY.	98480840 / VHC-60
TENNANT - CASTEX / NOBLES	612056	CASTER WHEEL	86709770 / WN-6
TENNANT - CASTEX / NOBLES	612059	BAG, FILTER (10 PACK) MAGNA TWIN, S-VAC,	86848360 / PBCX-2
TENNANT - CASTEX / NOBLES	612084	BAG,PAPER 6QT.10/PK	86633130 / PBT-1
TENNANT - CASTEX / NOBLES	612299	FILTER BAG	86677560 / PBT-4
TENNANT - CASTEX / NOBLES	612485	CIRCUIT BREAKER 25A (QBA) *	86608290 / ETN-4
TENNANT - CASTEX / NOBLES	612498	VALVE 24V.	86694410 / VTN-6
TENNANT - CASTEX / NOBLES	612792	BLADE	86702620 / T-2001XR-2A
TENNANT - CASTEX / NOBLES	612980	BLADE, SQUEEGEE FRONT LINATEX (QBA)	86851740 / T-2001XR-2B
TENNANT - CASTEX / NOBLES	613325	BAGS, FILTER (10 PACK) PORTAPAC, STRAP-A	86848610 / PBT-3
TENNANT - CASTEX / NOBLES	613422	MOTOR, DRIVE 1/2 HP 1500RPM 24V *	86844140 / MTN-1
TENNANT - CASTEX / NOBLES	613759	HOSE ASSY. VACUUM	98486170
TENNANT - CASTEX / NOBLES	621324	DRAIN PLUG 1 1/2"621324	86601910 / VTN-1
TENNANT - CASTEX / NOBLES	621445	MOTOR,BURNISHER-NOBLES 2250 56389422	86602460 / MTA-4
TENNANT - CASTEX / NOBLES	621478	CARBON BRUSH	86623320 / EC-44
TENNANT - CASTEX / NOBLES	626092	GASKET, 20/24 VAC MOTOR	86003870 / TN-G-6
TENNANT - CASTEX / NOBLES	626100	SOLUTION VALVE	86702890 / VTN-7

Visit our website for the most current and complete OEM interchange



OEM Interchange: Tennant-Castex/Nobles

OEM	OEM Part #	Material Description	Graco Part # / Old Graco#
TENNANT - CASTEX / NOBLES	626200	VAC MOTOR (116513-32)	86634340 / VM-26
TENNANT - CASTEX / NOBLES	630002	CASTER WHEEL	86709770 / WN-6
TENNANT - CASTEX / NOBLES	630010	GASKET, URE (.5 x 1.7ID x 3.5OD)	86657400
TENNANT - CASTEX / NOBLES	630052	FLOAT, 2701/3301	86621310
TENNANT - CASTEX / NOBLES	630288	SQUEEGEE BLADE- FRONT RED 30"LONG	88058580
TENNANT - CASTEX / NOBLES	630291	SQUEEGEE	86657360 / N-5300-3C
TENNANT - CASTEX / NOBLES	630309	GEAR BOX 54238A	86609030 / BLC-24
TENNANT - CASTEX / NOBLES	630340	BACK UP SQUEEGEE	86657370 / N-5300-3B
TENNANT - CASTEX / NOBLES	630344	SQUEEGEE BLADE	86658080 / N-5300-3A
TENNANT - CASTEX / NOBLES	630393	THUMB SCREW	86657700
TENNANT - CASTEX / NOBLES	630409	MOTOR/GEAR UNIT	86844120 / MTC-5
TENNANT - CASTEX / NOBLES	630450	Wheel 3" DIA CUSHION RUBBER	86011020 / WN-4
TENNANT - CASTEX / NOBLES	630477	WHEEL 2"x7/8", 3/8" BORE	86661470
TENNANT - CASTEX / NOBLES	700844	(k) ROLLER ASSY (SQUEEGEE)	98480700 / SPA-5
TENNANT - CASTEX / NOBLES	701061	DRAIN PLUG 1 1/4"	86006240 / VA-7
TENNANT - CASTEX / NOBLES	834108	(k) VAC. HOSE ASSY.	98480840 / VHC-60
TENNANT - CASTEX / NOBLES	834121	(k) VAC. HOSE ASSY.	98480840 / VHC-60
TENNANT - CASTEX / NOBLES	900000	BAGS, FILTER (10 PACK) LITE TRAC, VIPER,	86848340 / PBCX-1
TENNANT - CASTEX / NOBLES	900005	BAGS, FILTER (10 PACK) PORTAPAC, STRAP-A	86848610 / PBT-3
TENNANT - CASTEX / NOBLES	900035	BAGS, FILTER (10 PACK) LITE TRAC, VIPER,	86848340 / PBCX-1
TENNANT - CASTEX / NOBLES	900036	BAG, FILTER (10 PACK) MAGNA TWIN, S-VAC,	86848360 / PBCX-2
TENNANT - CASTEX / NOBLES	1001290	BLADE, RH SIDE 23.01"LONG	88058930
TENNANT - CASTEX / NOBLES	1006343	CASTER, SWIVEL, 50MMD, M10 X 30 STEM	86731190
TENNANT - CASTEX / NOBLES	1007072	MOLDED HOSE W/DRAIN CAP ASSY. 22"	86895230
TENNANT - CASTEX / NOBLES	1008639	CAP ASSY	86646480
TENNANT - CASTEX / NOBLES	1010143	MOLDED HOSE W/DRAIN CAP ASSY. 32"	86601850
TENNANT - CASTEX / NOBLES	1011167	HOSE SOLUTION DRAIN W/DRAIN CAP	86621490 / VHTN-7
TENNANT - CASTEX / NOBLES	1011168	DRAIN HOSE ASSY W/CAP	86621470 / VHTN-8
TENNANT - CASTEX / NOBLES	1011208	Switch, Snap, 10A	86870150
TENNANT - CASTEX / NOBLES	1011232	SQUEEGEE BLADE FRONT	86646510 / T-T3R-2B
TENNANT - CASTEX / NOBLES	1011376	SKIRT,CI NEO.33.51" LONG	88058940
TENNANT - CASTEX / NOBLES	1011402	SWITCH, KEY	86646520
TENNANT - CASTEX / NOBLES	1011456	SQUEEGEE BLADE REAR	86646530 / T-T3R-2A
TENNANT - CASTEX / NOBLES	1012022	8"x1 5/8" RUBBER WHEEL (QBA) W/3/4 BRGS(86608740 / WA-5
TENNANT - CASTEX / NOBLES	1012568	Switch, Snap, 10A, Short	88050750
TENNANT - CASTEX / NOBLES	1013132	(k) SWITCH	98480390 / ETN-17
TENNANT - CASTEX / NOBLES	1013432	^(k) VAC MOTOR 24V 3 STAGE w/ 1-1/2" TU	98481720 / VM-43B
TENNANT - CASTEX / NOBLES	1013531	SKIRT,CI NEO.27.27" LONG	88058950
TENNANT - CASTEX / NOBLES	1013763	Switch, Rocker, SPST, Paddle	86886890
TENNANT - CASTEX / NOBLES	1014026	(k) VACUUM HOSE 57" BLK W/CUFFS	98482070 / VHTN-9
TENNANT - CASTEX / NOBLES	1014091	SQUEEGEE BLADE FRONT 32" 1/8" GUM TN/T3	86852640 / T-T3-2B
TENNANT - CASTEX / NOBLES	1014093	SQUEEGEE BLADE,REAR 3/16" GUM TN T3	86852630 / T-T3-2A
TENNANT - CASTEX / NOBLES	1014268	DRAIN HOSE, STRETCH 1.5"x30" W/DRAIN CAP	86646630 / VHTN-10
TENNANT - CASTEX / NOBLES	1014274	HOSE ASSY,DRAIN 28" MOLDED W/2"CUFF	88050430
TENNANT - CASTEX / NOBLES	1015911	KNOB	86856920 / SNT-1
TENNANT - CASTEX / NOBLES	1015921	HOSE,VACUUM 1.5"x43" 2 CUFFS BLACK	98486200
TENNANT - CASTEX / NOBLES	1016275	Belt with Instruction Sheet	98486340
TENNANT - CASTEX / NOBLES	1016595	SOLUTION VALVE, SOLENOID 24V .25-20	86646620
TENNANT - CASTEX / NOBLES	1017380	DRAIN HOSE, STRETCH 1.5"x30" W/DRAIN CAP	86646630 / VHTN-10
TENNANT - CASTEX / NOBLES	1017696	KEY SET (2), REPLACEMENT	86737030

OEM Interchange

Visit our website for the most current and complete OEM interchange

Phone 1-800-872-4472

www.GracoMfg.com

Fax 1-888-872-4472



OEM	OEM Part #	Material Description	Graco Part # / Old Graco#
TENNANT - CASTEX / NOBLES	1017757	Vacuum motor 24VDC 2ST TD	86005440 / VM-29A+
TENNANT - CASTEX / NOBLES	1017757	24 VOLT 2 STAGE VAC MOTOR	86854670 / VM-29
TENNANT - CASTEX / NOBLES	1017868	SQUEEGEE BLADE, FRONT RED	88054320
TENNANT - CASTEX / NOBLES	1017868	SQUEEGEE BLADE, FRONT RED	88054320
TENNANT - CASTEX / NOBLES	1019295	SIDE SKIRT, NEO	88054330
TENNANT - CASTEX / NOBLES	1019295	SIDE SKIRT, NEO	88054330
TENNANT - CASTEX / NOBLES	1021333	SQ BLADE RED	86772770
TENNANT - CASTEX / NOBLES	1021804	SQ BLADE RED	86772760
TENNANT - CASTEX / NOBLES	1022013	SKIRT, HEAD, DISK, 32.0/800MM	86602810
TENNANT - CASTEX / NOBLES	1023271	24 VOLT 2 STAGE VAC MOTOR	86854670 / VM-29
TENNANT - CASTEX / NOBLES	1023327	Sq. Blade - 26/28" RED	86731280
TENNANT - CASTEX / NOBLES	1023329	Sq. Blade - 26/28 " RED	86731290
TENNANT - CASTEX / NOBLES	1023398	SQUEEGEE / 32" RED FRONT	86731300
TENNANT - CASTEX / NOBLES	1023399	BLADE / 32" RED REAR	86731310
TENNANT - CASTEX / NOBLES	1024586	SIDE SKIRT, NEO	88054340
TENNANT - CASTEX / NOBLES	1024586	SIDE SKIRT, NEO	88054340
TENNANT - CASTEX / NOBLES	1025106	VAC MOTOR,24V.3-STG	86854560 / VM23A+
TENNANT - CASTEX / NOBLES	1025109	24 VOLT 3 STAGE VAC MOTOR	86854550 / VM-23
TENNANT - CASTEX / NOBLES	1025333	BLADE, SQ, FRONT-GUM 24	86891310
TENNANT - CASTEX / NOBLES	1025335	SQUEEGEE, GUM 42-7/8X2 13 HOLES	86892950
TENNANT - CASTEX / NOBLES	1025337	SQ, GUM 43-1/2X1-15/16 13HOLES 20 NOTCH	86892940
TENNANT - CASTEX / NOBLES	1025340	SQUEEGEE, GUM 45-1/2X2" 13 HOLES	86892930
TENNANT - CASTEX / NOBLES	1025342	SQ, GUM 48 1/2X1-15/16 13 HOLES 17NOTCH	86892920
TENNANT - CASTEX / NOBLES	1025344	SQUEEGEE GUM 50-5/8X2 13 HOLES	86892910
TENNANT - CASTEX / NOBLES	1026222	BRUSH,SWEEP/SCRUB, 40" SUPER ABRASIVE	88055090
TENNANT - CASTEX / NOBLES	1026223	BRUSH,SWEEP/SCRUB, 40" POLY	88055100
TENNANT - CASTEX / NOBLES	1026292	SKIRT, CYLINDRICAL	86864190
TENNANT - CASTEX / NOBLES	1027688	BRUSH, SIDE POLY 24"	88057370
TENNANT - CASTEX / NOBLES	1029256	CHARGER 24V. 20A.	86738010 / CH-31
TENNANT - CASTEX / NOBLES	1029695	CASTER WHEEL	86709770 / WN-6
TENNANT - CASTEX / NOBLES	1031011	SQUEEGEE BLADE,SIDE RED	88054360
TENNANT - CASTEX / NOBLES	1031011	SQUEEGEE BLADE,SIDE RED	88054360
TENNANT - CASTEX / NOBLES	1031331	SQUEEGEE BLADE, REAR RED	88054370
TENNANT - CASTEX / NOBLES	1031331	SQUEEGEE BLADE, REAR RED	88054370
TENNANT - CASTEX / NOBLES	1033246	BRUSH,SWEEP/SCRUB, 48" 24SR POLYESTER	88055110
TENNANT - CASTEX / NOBLES	1033372	BRUSH,SWEEP/SCRUB, 48"SUPER ABRASIVE	88055120
TENNANT - CASTEX / NOBLES	1033374	BRUSH,SWEEP/SCRUB, 48" 24SR HD POLY	88055130
TENNANT - CASTEX / NOBLES	1033375	BRUSH,SWEEP/SCRUB, 48" 24SR POLY	88055140
TENNANT - CASTEX / NOBLES	1035052	SQUEEGEE BLADE, REAR RED M30	88054380
TENNANT - CASTEX / NOBLES	1035052	SQUEEGEE BLADE, REAR RED M30	88054380
TENNANT - CASTEX / NOBLES	1035067	SQUEEGEE BLADE, FRONT RED M30	88054390
TENNANT - CASTEX / NOBLES	1035067	SQUEEGEE BLADE, FRONT RED M30	88054390
TENNANT - CASTEX / NOBLES	1037821	FILTER VAC 5700/5680	86665940 / FTN-4
TENNANT - CASTEX / NOBLES	1037822	FILTER, VAC FAN	86785820
TENNANT - CASTEX / NOBLES	1038080	SQUEEGEE BLADE	86678180 / WR-26-3C
TENNANT - CASTEX / NOBLES	1039617	36 VOLT 3 STAGE VAC MOTOR	86854650 / VM-280
TENNANT - CASTEX / NOBLES	1039763	Vac Motor Assembly, 24V	98486280
TENNANT - CASTEX / NOBLES	1042499	BRUSH ASSY, DISC 16" NYLON	88057390
TENNANT - CASTEX / NOBLES	1043530	(k)DRAIN HOSE ASSY	98483200
TENNANT - CASTEX / NOBLES	1043538	DRAIN HOSE, STRETCH 1.5"X30" W/DRAIN CAP	86646630 / VHTN-10

Visit our website for the most current and complete OEM interchange



OEM	OEM Part #	Material Description	Graco Part # / Old Graco#
TENNANT - CASTEX / NOBLES	1044393	SWITCH, ROCKER SPDT	86899410
TENNANT - CASTEX / NOBLES	1044804	SWITCH,ROCKER W/CAP	86602950 / EN-4
TENNANT - CASTEX / NOBLES	1049046	5" POLY SWIVEL CASTER(F) (QBA)	86606110 / WC-3
TENNANT - CASTEX / NOBLES	1049048	CASTER WHEEL	86709770 / WN-6
TENNANT - CASTEX / NOBLES	1049049	5" POLY SWIVEL CASTER(F) (QBA)	86606110 / WC-3
TENNANT - CASTEX / NOBLES	1052672	TIRE ASSY,GRAY HD FOAM,410/3.5-6 3.5BC	98486050 / WTN-7
TENNANT - CASTEX / NOBLES	1052673	TIRE & RIM ASSY	86642750 / WTN-8
TENNANT - CASTEX / NOBLES	1062393	(k) VALVE, WATER SOL 36VDC (QBA)	98481410 / VTN-5
TENNANT - CASTEX / NOBLES	2089670	VALVE COVER GASKET	86637030 / PB-21
TENNANT - CASTEX / NOBLES	2089977	OIL FILTER TUBE	86636280 / PB-24
TENNANT - CASTEX / NOBLES	2280006	O-RING	86639550 / PB-25
TENNANT - CASTEX / NOBLES	2485068	OIL DIP STICK	86636300 / PB-40
TENNANT - CASTEX / NOBLES	2690911	LID-VAC (S-2001)100105	86602300 / N-L-1
TENNANT - CASTEX / NOBLES	2910727	AIR CLEANER ELEMENT	86634440 / PB-20
TENNANT - CASTEX / NOBLES	3096773	24V VAC MOTOR (QBA) (116155-00)	86601190 / VM-1
TENNANT - CASTEX / NOBLES	3112299	HEAD GASKET	86634530 / PB-18
TENNANT - CASTEX / NOBLES	4145660	GASKET	86639590 / PB-23
TENNANT - CASTEX / NOBLES	9002562	VAC MOTOR,24V.3-STG	86854560 / VM23A+
TENNANT - CASTEX / NOBLES	9003644	(k) WHEEL, 8"OD X 2"	98481000 / WTN-4
TENNANT - CASTEX / NOBLES	9004054	VAC MOTOR KIT, W/PLUG, GASKET	98486180
TENNANT - CASTEX / NOBLES	9004055	VAC MOTOR, 36V 3STG (W FEM TERM)	98484280
TENNANT - CASTEX / NOBLES	9007744	BAG, VACUUM (10 BAGS, 2 FILTERS)	88024800
TENNANT - CASTEX / NOBLES	039705012	SWITCH	86652590 / ETN-1
TENNANT - CASTEX / NOBLES	039705081	SWITCH	86652590 / ETN-1
TENNANT - CASTEX / NOBLES	067760601	SQUEEGEE BLADE	86678170 / WR-26-3A
TENNANT - CASTEX / NOBLES	067760602	SQUEEGEE BLADE	86678180 / WR-26-3C
TENNANT - CASTEX / NOBLES	067760603	SQUEEGEE BLADE, GUM REAR, 36" T-5736-2GA	86683370 / WR-26-3B
TENNANT - CASTEX / NOBLES	067760603	BLADE BACKUP	86684870 / WR-26-3B
TENNANT - CASTEX / NOBLES	067760688	FILTER,VAC	86839960 / FTN-1
TENNANT - CASTEX / NOBLES	067761601	BLADE, TAN GUM 3-3/4"x3/16"x49-1/4" -10	86856100 / WR-32-3A
TENNANT - CASTEX / NOBLES	067761602	BLADE, TAN GUM 2-3/4"x1/8"x46-3/8" -10 H	86856120 / WR-32-3C
TENNANT - CASTEX / NOBLES	067761603	BLADE, NEO 3"x1/8"x48-3/4" -10 Holes	86856110 / WR-32-3B
TENNANT - CASTEX / NOBLES	069760030	5" POLY SWIVEL CASTER(F) (QBA)	86606110 / WC-3
TENNANT - CASTEX / NOBLES	069760038	STRAINER, ROUND 5/8" OPENING	86606580 / FC-2
TENNANT - CASTEX / NOBLES	069760241	GASKET FOAM	86717460 / TN-G-2
TENNANT - CASTEX / NOBLES	069760242	GASKET,ADAPTOR	86852400 / TN-G-1
TENNANT - CASTEX / NOBLES	069760440	SOLENOID 36v 41802A - etn16	86620760 / ETN-16
TENNANT - CASTEX / NOBLES	069760441	Relay 36VDC 100AMP HVY DUTY	86006370 / EA-80
TENNANT - CASTEX / NOBLES	069760456	SWITCH	86634620 / EA-32
TENNANT - CASTEX / NOBLES	069760577	SWITCH 56325758	86634370 / ETN-15
TENNANT - CASTEX / NOBLES	069760631	VALVE WATER 1/2"	86711450 / VTN-2
TENNANT - CASTEX / NOBLES	069760642	SWITCH,ROCKER	86622080 / ETN-20
TENNANT - CASTEX / NOBLES	069762039	CIRCUIT BREAKER 25A (QBA) *	86608290 / ETN-4
TENNANT - CASTEX / NOBLES	069762222	CIRCUIT BREAKER 22A	86620770 / ETN-5
TENNANT - CASTEX / NOBLES	069762242	CIRCUIT BREAKER (17 AMP)	86608510 / EA-24
TENNANT - CASTEX / NOBLES	069762333	CENTERLOCK RING-ORANGE	86620740 / PH-4
TENNANT - CASTEX / NOBLES	069762379	S.B. PLUG 50A grey 911185	86634080 / CHP-2
TENNANT - CASTEX / NOBLES	069762407	TIRE	86601170 / WTN-1
TENNANT - CASTEX / NOBLES	069762408	INNER TUBE -4.10-3.50X5	86601010 / WTN-2
TENNANT - CASTEX / NOBLES	069762427	MOTOR-BRUSH 45037A	86606340 / MTC-2

Visit our website for the most current and complete OEM interchange



OEM	OEM Part #	Material Description	Graco Part # / Old Graco#
TENNANT - CASTEX / NOBLES	069762432	3/4 H.P. BRUSH MOTOR	86609140 / F732775
TENNANT - CASTEX / NOBLES	069764009	(k) SWITCH	98480390 / ETN-17
TENNANT - CASTEX / NOBLES	069764608	Connector 175 DCA GRY W/O TERMS	88068250 / CHP-3
TENNANT - CASTEX / NOBLES	069767082	(k) WHEEL, 8"OD X 2"	98481000 / WTN-4
TENNANT - CASTEX / NOBLES	069767101	(k) 175 AMP PLUG W/ CABLE	98483160 / CHP-3-A
TENNANT - CASTEX / NOBLES	199201001	SQUEEGEE SET	86852330 / TN-16T-4
TENNANT - CASTEX / NOBLES	199201002	SQUEEGEE SET	98486000 / TN-17-6
TENNANT - CASTEX / NOBLES	199201017	SQUEEGEE SET	98485130 / WR-26-3
TENNANT - CASTEX / NOBLES	199201018	SQUEEGEE SET	98485140 / WR-32-3
TENNANT - CASTEX / NOBLES	205004002	BEARING	86626350 / CB-9
TENNANT - CASTEX / NOBLES	469760860	36V 2 STAGE VAC MTR (QBA) (116156-00)	86854510 / VM-2
TENNANT - CASTEX / NOBLES	469760861	VAC MOTOR	86623200 / VM-42
TENNANT - CASTEX / NOBLES	469760868	CHARGER 36V 25A AUTO (50A GRAY)	86738020 / CH-3850G
TENNANT - CASTEX / NOBLES	469764962	CHARGER 36V 25A AUTO (50A GRAY)	86738020 / CH-3850G
TENNANT - CASTEX / NOBLES	577637800	VAC MOTOR	86603040 / WV-19
TENNANT - CASTEX / NOBLES	601102000	CHARGER,36V- 40A	86632130 / CH-40
TENNANT - CASTEX / NOBLES	602002000	CHARGER,36V- 40A	86632130 / CH-40
TENNANT - CASTEX / NOBLES	611248000	VAC MOTOR (116513-32)	86634340 / VM-26
TENNANT - CASTEX / NOBLES	611266000	SWITCH 56325758	86634370 / ETN-15
TENNANT - CASTEX / NOBLES	611286000	MOTOR END	86606180 / MC-1-EI
TENNANT - CASTEX / NOBLES	611333000	DRIVE WHEEL	86622170 / WTN-3
TENNANT - CASTEX / NOBLES	621237000	CENTER PAD HOLDER L.H.56393567	86633810 / PH-6-L
TENNANT - CASTEX / NOBLES	621267000	36V 2 STAGE VAC MTR (QBA) (116156-00)	86854510 / VM-2
TENNANT - CASTEX / NOBLES	621324000	DRAIN PLUG 1 1/2"621324	86601910 / VTN-1
TENNANT - CASTEX / NOBLES	0174..34	BLADE, GUM (QBA) 2-1/4"x1/4"x25-1/2" -12	86844510 / N-24-2A
TENNANT - CASTEX / NOBLES	069760440AM	SOLENOID 36v 41802A - etn16	86620760 / ETN-16
TENNANT - CASTEX / NOBLES	08013N	BRUSH,SIDE SWEEP, 23"NYLON	88055180
TENNANT - CASTEX / NOBLES	1014918AM	WHEEL	86726670 / WN-3
TENNANT - CASTEX / NOBLES	130415AM	120 VOLT 2 STAGE VAC MOTOR (VM-13)	86854420 / VM-13
TENNANT - CASTEX / NOBLES	130477AM	VAC MOTOR,24V.3-STG	86854560 / VM23A+
TENNANT - CASTEX / NOBLES	130737AM	10 AMP BREAKER	86608930 / EA-72
TENNANT - CASTEX / NOBLES	25707AM	LOCK, PAD DRIVER BLUE	86246740 / PH-6
TENNANT - CASTEX / NOBLES	28007P	BRUSH, SWEEP, 26" 6DR, POLY	88057880
TENNANT - CASTEX / NOBLES	51021N	BRUSH,SIDE SWEEP, 26"NYLON	88055190
TENNANT - CASTEX / NOBLES	601468AM	(k) VAC MOTOR (VM-29 w/ 1-1/2" TUBE) 458	98482060 / VM-29-B
TENNANT - CASTEX / NOBLES	603487AM	15A.CIRCUIT BRK.740130	86618740 / EA-34
TENNANT - CASTEX / NOBLES	611333000AM	DRIVE WHEEL	86622170 / WTN-3
TENNANT - CASTEX / NOBLES	612498AM	VALVE 24V.	86694410 / VTN-6
TENNANT - CASTEX / NOBLES	63268-1	TIRE	86601170 / WTN-1
TENNANT - CASTEX / NOBLES	63268-2	INNER TUBE -4.10-3.50X5	86601010 / WTN-2
TORNADO	3008	FILTER EQUAL TO 3008	86839230 / FB-1
TORNADO	3398	GASKET EQUAL TO 3398	86827930 / B-G-2
TORNADO	3481	BLADE, NEO (QBA) 2-5/8"x3/16"x19" -6 Hls	86827380 / B-3500-2B
TORNADO	3482	BLADE, NEO (QBA) 3"x3/16"x20-3/4" -6 Hol	86827370 / B-3500-2A
TORNADO	3492	GASKET DRAIN DOOR	86622300 / B-G-1
TORNADO	3821	GASKET, FOAM 4" OD, 3" ID	86827950 / B-G-4
TORNADO	3838	BLADE, TAN GUM (QBA) 2-5/8x1/4"x30" - 10	86827470 / B-9300-2B
TORNADO	3839	BLADE, TAN GUM (QBA) 1-3/4"x1/4"x25" -8	86827460 / B-9300-2A
TORNADO	5422	BLADE, NEO (QBA) 2"x1/4"x19" -6 Hls,3 V N	86827410 / B-3500M-2B
TORNADO	5423	BLADE, NEO (QBA) 2-5/8"x1/4"x21" -6 Holes	86827400 / B-3500M-2A

Visit our website for the most current and complete OEM interchange



OEM	OEM Part #	Material Description	Graco Part # / Old Graco#
TORNADO	6503	SWITCH	86634210 / EB-13
TORNADO	6685	SWITCH	86601150 / EB-20
TORNADO	6889	SWITCH ASY	86717280 / ET-5
TORNADO	10203	TIMER 12 HR. W/O KNOB (KNOB PART# 02003)	86832190 / CHP-14
TORNADO	10333	SOLENOID 36V.56395452,	86606490 / EC-43
TORNADO	10365	INLET FILTER	86652530 / FC-62
TORNADO	10445	BEARING AS. EQUAL TO10445	86842970 / MB-7
TORNADO	10470	BLADE, TAN GUM (QBA) 1-3/4"x1/4"x34" - 1	86827560 / B-9400-2B
TORNADO	10471	BLADE, TAN GUM (QBA) 2-5/8"x1/4"x39" - 1	86827550 / B-9400-2A
TORNADO	10490	WHEEL(10")EQUAL TO 13757(I10020A4A-503/	86856130 / WT-1
TORNADO	10516	CIRCUIT BREAKER,32AMP	86633670 / EB-14
TORNADO	10553	(k) CHAIN EQUAL TO 10553	98480250 / BLT-2
TORNADO	10587	BUMPER WHEEL	86618540 / WA-10
TORNADO	12485	SWITCH	86601150 / EB-20
TORNADO	12508	4"CASTER WHEEL W/STEM (QBA) (F)	86608480 / WC-4
TORNADO	12632	FLOAT-LEADER 833301	86607050 / FC-6
TORNADO	12973	BUFFER CORD 50' 14/3 RED	86617190 / E-452R
TORNADO	13095	GASKET	86622310 / B-G-11
TORNADO	13104	Filter VAC MOTOR	86003510 / FA-1
TORNADO	13197	SWITCH N.C./N.O.(PRES.)	86652610 / EA-31
TORNADO	13386	BLADE, GUM (QBA)1-7/8"x1/4"21" - 8 Holes	86827440 / B-9200-2B
TORNADO	13387	BLADE, GUM (QBA) 1-7/8"x1/4"21" - 8 Hole	86827430 / B-9200-2A
TORNADO	13396	BLADE, GUM (QBA)1-7/8"x1/4"21" - 8 Holes	86827440 / B-9200-2B
TORNADO	13493	(k) VACUUM HOSE ASSEMBLY	98481100 / VHB-1
TORNADO	13700	4X2 POLY WHEEL W/BRG(F)	86616310 / WA-1-W
TORNADO	13704	CASTER W/WHEEL (5-3/8) 56365555,630002	86618730 / WA-1
TORNADO	13757	WHEEL(10")EQUAL TO 13757(I10020A4A-503/	86856130 / WT-1
TORNADO	13817	WHEEL(10")EQUAL TO 13757(I10020A4A-503/	86856130 / WT-1
TORNADO	13944	SWITCH	86601150 / EB-20
TORNADO	14002	GASKET	86622310 / B-G-11
TORNADO	14038	CIRCUIT BREAKER (17 AMP)	86608510 / EA-24
TORNADO	14454	CIRCUIT BREAKER-38 AMP	86634700 / EB-38
TORNADO	14466	PUMP-LITTLE GIANT (QBA)	86842540 / M-20
TORNADO	14482	CASTER W/WHEEL (5-3/8) 56365555,630002	86618730 / WA-1
TORNADO	14528	4X2 POLY WHEEL W/BRG(F)	86616310 / WA-1-W
TORNADO	14530	CASTER W/WHEEL (5-3/8) 56365555,630002	86618730 / WA-1
TORNADO	15197	STRAINER, ROUND 1" OPENING	86619900 / FA-3
TORNADO	15484	CENTERLOCK-PAD HOLDER	86633860 / PH-7
TORNADO	15494	CENTERLOCK-PAD HOLDER	86633860 / PH-7
TORNADO	15511	SWITCH - WHITE BRUSH	86622430 / EB-40
TORNADO	15515	36 VOLT 3 STAGE VAC MOTOR	86854720 / VM-30
TORNADO	15652	BLADE, TAN GUM (QBA) 2-5/8"x3/16"x39-1/2	86827590 / B-9420-2B
TORNADO	15654	BLADE, TAN GUM (QBA) 1-3/4"x1/4"x35-1/2"	86827580 / B-9420-2A
TORNADO	15717	GASKET CLEAN OUT DOOR	86827960 / B-G-5
TORNADO	16217	BATTERY CABLE	86827890 / BCSN415
TORNADO	16259	BLADE, TAN GUM (QBA) 1-3/4"x1/4"x42" - 1	86827650 / B-9945-2B
TORNADO	16260	BLADE, TAN GUM (QBA) 2-5/8"x3/16"x45-1/2	86827640 / B-9945-2A
TORNADO	16429	SWITCH - WHITE BRUSH	86622430 / EB-40
TORNADO	16609	GASKET, FOAM 4" OD, 3" ID	86827950 / B-G-4
TORNADO	16622	GASKET BACKING PLATE	86827970 / B-G-7

Visit our website for the most current and complete OEM interchange



OEM	OEM Part #	Material Description	Graco Part # / Old Graco#
TORNADO	16685	BLADE, TAN GUM (QBA) 1-3/4"x1/4"29-1/2"	86827490 / B-9320-2A
TORNADO	16686	BLADE, TAN GUM (QBA) 2-5/8"x3/16"x32-1/2	86827500 / B-9320-2B
TORNADO	16691	BLADE, TAN GUM (QBA) 1-3/4"x1/4"x34" - 1	86827520 / B-9350-2A
TORNADO	16692	BLADE, TAN GUM (QBA) 2-5/8"x3/16"x36-3/4	86827530 / B-9350-2B
TORNADO	17087	SWITCH - WHITE BRUSH	86622430 / EB-40
TORNADO	17248	SQUEEGEE FRONT	86622380 / B-9930-2C
TORNADO	17249	BLADE, GUM (firm) (QBA) 2-5/8"x1/4"x31-7	86827610 / B-9930-2B
TORNADO	17261	BLADE, GUM (soft) (QBA) 2-5/8"x3/16"x31-	86827600 / B-9930-2A
TORNADO	17646	GASKET CLEAN OUT DOOR	86827960 / B-G-5
TORNADO	17647	GASKET BACKING PLATE	86827970 / B-G-7
TORNADO	17910	MOTOR .75 GEAR 36 VOLT	86838680 / F755400
TORNADO	18031	SWITCH - WHITE BRUSH	86622430 / EB-40
TORNADO	18032	SWITCH - RED MAIN	86622420 / EB-41
TORNADO	18075	(K) VAC MOTOR 24V, 1-7/8" TUBE	98482100 / VM-34B
TORNADO	18418	TIMING BELT (OLD STYLE) STEEL REINFORCED	86829110 / BLT-1-S
TORNADO	18484	SWITCH - VAC WHITE	86622410 / EB-42
TORNADO	18491	(k) CHAIN EQUAL TO 10553	98480250 / BLT-2
TORNADO	18624	(k) CHAIN EQUAL TO 10553	98480250 / BLT-2
TORNADO	18773	CASTER W/WHEEL (5-3/8) 56365555,630002	86618730 / WA-1
TORNADO	18884	(K) VAC MOTOR 24V, 1-7/8" TUBE	98482100 / VM-34B
TORNADO	19462	BUFFER CORD 50' 14/3 RED	86617190 / E-452R
TORNADO	19473	CORD 75' 14/3 YELLOW ST 600V	86695500 / E-4752Y
TORNADO	20996	TIMER 12 HR. W/O KNOB (KNOB PART# 02003)	86832190 / CHP-14
TORNADO	22497	AMMETER (2000S)	86637310 / CHP-10
TORNADO	22681	PUMP-LITTLE GIANT (QBA)	86842540 / M-20
TORNADO	22700	PUMP-LITTLE GIANT (QBA)	86842540 / M-20
TORNADO	26198	BREAKER, 30A 50VDC CIRCUIT - VAC MOTOR	86001910 / EA-29
TORNADO	26412	SWITCH	86601150 / EB-20
TORNADO	26412	SWITCH	86601150 / EB-20
TORNADO	90141	BAG, VACUUM (10 BAGS, 2 FILTERS)	88024800
TORNADO	63911710	Suction hose DN32	63911710
TORNADO	69042940	BAGS, FILTER (10-PACK) FOR KARCHER/TORNA	69042940
TORNADO	K63911710	Suction hose DN32	63911710
TORNADO	K69042940	BAGS, FILTER (10-PACK) FOR KARCHER/TORNA	69042940
VIPER	VF81203A	HOSE ASSY.	98486740
WINDSOR	0506	SWITCH	86656790 / WV-1
WINDSOR	0517	SWITCH	86656790 / WV-1
WINDSOR	0582	MICRO SWITCH	86143250
WINDSOR	1034	RETAINING RING	86640860
WINDSOR	1044	MOTOR FILTER U19836	86143330 / WV-6
WINDSOR	1051	HOSE	86142630 / WV-3
WINDSOR	1419	VAC MOTOR	86603040 / WV-19
WINDSOR	1435	FLR, HOSP GRADE-.3MICR U19835	86001790
WINDSOR	1516	HOSE	86142630 / WV-3
WINDSOR	1534	FILTER, VSE EXHAU	86640920
WINDSOR	1878	EXHAUST FILTER 370/470	86141370 / WV-25
WINDSOR	2003	PAPER FILTERBAGS, PKG/10 (444955)	86813300 / WV-15
WINDSOR	2025	PULLEY-MOTOR	86640900 / WV-11
WINDSOR	2045	CLUTCH PLATE	86140120 / 2045
WINDSOR	2046	BRUSH STRIP, 14" U19838	86002440 / WV-7

Visit our website for the most current and complete OEM interchange



OEM	OEM Part #	Material Description	Graco Part # / Old Graco#
WINDSOR	2047	BEARING BLOCK, VSM/VSE RH	86138100 / WV-14
WINDSOR	2091	BEARING BLOCK, VSM/VSE LH	86138110 / WV-13
WINDSOR	2241	BRUSH DRIVE MOTOR, 115V U70G32	86138460 / WV-20
WINDSOR	4022	BRUSH MOTOR, 115V U70G40	86138580 / WV-21
WINDSOR	4024	DRIVE BELT	86866560 / BLW-1
WINDSOR	4028	BRUSH STRIP, 18" MODEL U19840	86001640 / WV-8
WINDSOR	5110	Belt HTD-II, 219 3M	86005000 / 5110
WINDSOR	5300	BAGS, FILTER (10PK)SENSOR XP12 VSP APC	86863970 / PBW-1
WINDSOR	7063	ALUMINUM TANK W/GAUGE	86722010 / PB-9A
WINDSOR	07073	BELT OPTIBELT	86830750
WINDSOR	14050	BLADE, 13 IN LEFT	86001410 / W-C26-SL
WINDSOR	14717	BREAKER, 3 AMP 1681-090-300	86002000 / EA-22
WINDSOR	18041	CASTER, 4DIA X 2 W X 3.56 R	86002310 / WN-1
WINDSOR	20016	CLAMP, 1/4 ID HOSE	86233090 / PW-6
WINDSOR	22015	Coupler 1/4 QD	86002450 / PW-3
WINDSOR	23011	CORD SET,18/3 SJT RIB X40' BLU	86135510 / WV-26
WINDSOR	23086	CORD SET, 14/3 ST X 50' YLW	86234150 / E-452Y
WINDSOR	23167	CORD SET, 14/3 ST X 50' YLW	86234150 / E-452Y
WINDSOR	27759	CUFF, HOSE 1.5" BLK A 2161	86003010 / HC-7B
WINDSOR	28038	CLAMP, CABLE KIT	86233360 / CHP-13
WINDSOR	34012	Filter VAC MOTOR	86003510 / FA-1
WINDSOR	35087	VACUUM MOTOR GASKET	86839430 / FB2496
WINDSOR	35166	GASKET, VAC MTR	86003760 / AD-G-5
WINDSOR	35211	GASKET, 8.50 X 16.40 X .50T	86003840 / S35211
WINDSOR	35212	GASKET, 6.30 X 16.1 X .50T - WINDSOR	86003850 / S35212
WINDSOR	35214	GASKET, 20/24 VAC MOTOR	86003870 / TN-G-6
WINDSOR	35216	GASKET, 10.30 X 17.80 X 50T	86003890 / S35216
WINDSOR	35249	GASKET, SQG .13 THK X 8.00 LG	86003980 / N-G-4
WINDSOR	35276	VACUUM MOTOR GASKET	86839430 / FB2496
WINDSOR	39315	Hose 1.5 BLK VAC X 28"	86004180 / 39315
WINDSOR	40009	HOSEBARB, 1/4MPT X 1/4 DL	86197500 / PW-5
WINDSOR	41161	CENTERLOCK-PAD HOLDER	86633860 / PH-7
WINDSOR	48012	KNOB, 5/16-18 4 PRONG	86004790 / SPA-3
WINDSOR	51284	Lock PAD CENTER SNAP,TWO STEP	86005070 / PH-8
WINDSOR	51353	LOCK, PAD DRIVER BLUE	86246740 / PH-6
WINDSOR	53001	VAC MOTOR, A+ 120V 2STG TF	86854910 / VM4A+
WINDSOR	53082	VAC MOTOR, 115V 5.7 2ST P/D	86258410 / VM-7A+
WINDSOR	53134	VAC MOTOR, 120V 5.7 3ST TD TB	86258430 / VM-31A+
WINDSOR	53177	VAC MOTOR, 36V 5.7 3ST TD	86258480 / VM-280A+
WINDSOR	53204	36 VOLT 3 STAGE VAC MOTOR	86854720 / VM-30
WINDSOR	53231	36 VOLT 3 STAGE VAC MOTOR	86854720 / VM-30
WINDSOR	53630	MOTOR ASM, 24VDC 200RPM GEAR	86005320 / MTC-5A+
WINDSOR	53774	VAC MOTOR ASM, 115V 4.8 2ST PD	86026750 / VM-46
WINDSOR	53800	VAC MOTOR ASM, 115V 4.8 2ST PD	86026750 / VM-46
WINDSOR	53801	VAC MOTOR ASM, 24VDC 3 STAGE	86005460 / VM-34A+
WINDSOR	56012	Nipple 1/4 FPT QD	86005580 / PW-4
WINDSOR	65142	PUMP ASM, 36VDC VGR	86026340 / M-105
WINDSOR	65166	PUMP ASM, 36VDC VGR	86026340 / M-105
WINDSOR	66227	DRAIN PLUG 1 1/4"	86006240 / VA-7
WINDSOR	67315	Relay 36VDC 100AMP HVY DUTY	86006370 / EA-80

Visit our website for the most current and complete OEM interchange



OEM	OEM Part #	Material Description	Graco Part # / Old Graco#
WINDSOR	68004	BAG, CLOTH (10 qt)COACHVAC, SUPER COACH,	86848640 / PBT-5
WINDSOR	68005	BAG,PAPER 10QT.10/PK	86198850 / 68005
WINDSOR	68006	FILTER ASSY	86647750 / FPT-1
WINDSOR	68008	FILTER ASSY	86647750 / FPT-1
WINDSOR	68066	HOSE ASSEMBLY	86198940 / HPT-1
WINDSOR	68074	FILTER BAG	86677560 / PBT-4
WINDSOR	72004	SWITCH-ROCKER	86609650 / E-81
WINDSOR	72008	SWITCH-ROCKER	86609650 / E-81
WINDSOR	72015	SWITCH	86634620 / EA-32
WINDSOR	72017	SWITCH, PUMP PRESSURE	86137080 / M-41-PS
WINDSOR	72128	Switch DPDT 2-POSITION ROCKER	86007130 / EA-81
WINDSOR	73794	BLADE, GUM (QBA) 3-1/2"x3/16" (front)	86855210 / W-28-2B
WINDSOR	73795	BLADE, GUM (QBA) 3-1/2"x1/4"x44-1/2" (re	86855200 / W-28-2A
WINDSOR	73802	BLADE, SQ. TR24 DIE CUT FRONT	86007890 / W-24-2B
WINDSOR	73894	SQGE BLADE, FRONT LINATEX 35"	86008020 / W-C26-2B
WINDSOR	73976	SQUEEGEE, REAR BLADE LINATEX	86008170
WINDSOR	80682	Connector 175 DCA GRY W/O TERMS	88068250 / CHP-3
WINDSOR	81535	KNOB, 3/8-16 4 PRONG ALUM	86009200 / SC-10
WINDSOR	81555	SQUEEGEE, SIDE CYL. SCRUB	86009240 / W-FC-S
WINDSOR	82528	Squeegee front Blatt LINATEX	86009830 / W-C32-2B
WINDSOR	82803	Connector 175 DCA RED W/O TERMS	88068240 / CHP-3-R
WINDSOR	84018	VALVE	86642210 / VE-1
WINDSOR	84141	Valve 24VDC SOL.1/2"HOSEBARB	86010540 / VWN-1
WINDSOR	89202	Wheel 3" DIA CUSHION RUBBER	86011020 / WN-4
WINDSOR	100743	SWITCH, VP6/10	86199120 / SPT-1
WINDSOR	140506	BLADE, 13IN RIGHT	86001400 / W-C26-SR
WINDSOR	140527	BLADE, AQ RIGHT 16 INCH	86001420 / W-C32-SR
WINDSOR	140528	BLADE, AQ LEFT 16 INCH	86001430 / W-C32-SL
WINDSOR	140763	BLADE, SQU, REAR 40.6 LINATEX	86001580
WINDSOR	140764	BLADE, SQU, FRONT 36.7 RED GUM	86001630
WINDSOR	730003	BLADE,BLU_RIB FRT/REAR_URETHAN	86007260 / S730003
WINDSOR	730114	SQUEEGEE, REAR BLADE LINTEX	86007430 / W-C26-2A
WINDSOR	730119	SKIRT, 26INCH, LEFT	86007440 / W-C264-SL
WINDSOR	730120	SKIRT, 26INCH, RIGHT	86007450 / W-C264-SR
WINDSOR	730133	SQUEEGEE, REAR BLADE, LINTEX	86007490 / W-C32-2A
WINDSOR	1500431	Belt with Instruction Sheet	98486340
WINDSOR	56397215	Valve 36VDC SOL.1/2" HOSEBARB	86009710 / VWN-2
WINDSOR	86000360	BRUSH, 17" POLY SD U19973	86000360
WINDSOR	86000500	Sensor FILTER BAG PACK	86000500
WINDSOR	86012210	VAC MOTOR, 36VDC 2ST TD	86012210 / VM-27A+
WINDSOR	1419UL	VAC MOTOR	86603040 / WV-19
WINDSOR	1516HG	HOSE	86142630 / WV-3
WINDSOR	1516OE	HOSE	86142630 / WV-3
WINDSOR	2030ER	BRUSH ASM, 14 IN.	86138430 / 2030ER
WINDSOR	2241UL	BRUSH DRIVE MOTOR, 115V U70G32	86138460 / WV-20
WINDSOR	241UE	BRUSH DRIVE MOTOR, 115V U70G32	86138460 / WV-20
WINDSOR	250-78	PUMP, 110/120 60HZ FLOJET	86201110 / M-108
WINDSOR	4022UL	BRUSH MOTOR, 115V U70G40	86138580 / WV-21

Visit our website for the most current and complete OEM interchange



OEM	OEM Part #	Material Description	Graco Part # / Old Graco#
WINDSOR	4033ER	BRUSH ASM COMPLETE, 18"	86138590 / 4033ER
WINDSOR	5010WI	BRUSH ROLLER 12"	86004950 / 5010WI
WINDSOR	5287BLU	Bearing BLK, RH SR12 BLU/GRY	86138170 / 5287BLU
WINDSOR	5290WI	BRUSH, ROLLER SR15	86138810 / 5290WI
WINDSOR	53001R	VAC MOTOR, A+ 120V 2STG TF	86854910 / VM4A+
WINDSOR	5301ER	MICRO-HYGIENE FILTER	86874840 / WV-23
WINDSOR	5766HG	BEARING BLOCK, LH, XP12	86138200 / 5766HG
WINDSOR	8.600-088.0	Switch blue	86000880

OEM Interchange

Visit our website for the most current and complete OEM interchange



Aftermarket Parts & Accessories



Graco sells top quality batteries to our customers.

Graco is proud to offer AGM batteries in addition to our Flooded line. Below are the features of each type, so no matter what the need, you'll find the right battery for you.

FLOODED BATTERY

- Most common lead-acid battery in use today with years of proven success.
- Provides massive amounts of reserve power.
- Great life expectancy with proper maintenance.
- Lowest manufacturing cost.
- Dependable against harsh conditions.
- Low tolerance for heat (for every 15° F above 80° F, they will lose half of their service life)
- High self discharge rate
- Must be installed upright
- Not suitable for high vibration

SEALED LEAD ACID (AGM) BATTERY

- Increased surface area of the plate helps retard corrosion and extends the life of the grid.
- The use of thicker grids gives more corrosion resistance.
- Plates are never subjected to destructive ultra-deep discharges due to their "acid-starved" nature.
- AGM batteries have the best balance between capacity utilization and recombination efficiency by containing separators at the ideal compression and saturation. These dual insulating separators also prevent separator misalignment as well shorting at the bottom and sides of the plates.
- Excels in high current, high power applications and in extremely cold environments.



8.633-283.0



8.663-285.0

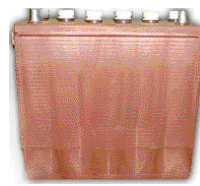

8.622-841.0



8.663-292.0



Standard Terminal

GRACO# OLD GRACO#	Type	V	AH Rating	RC @25A	RC @75A	Terminals	Size	Style
8.663-283.0 BT-1	Flooded	6	250	475	130	STD	11-5/8L x 7W x 11-7/8H	
8.683-060.0	AGM	6	260	572	149	STD	11-5/8L x 7W x 11-7/8H	250
8.663-285.0 BT-2	Flooded	6	330	620	170	STD	12-1/4L x 7W x 14-3/8H	
8.683-061.0	AGM	6	312	736	208	STD	12-1/4L x 7W x 14-3/8H	305
8.622-841.0 BT-3	Flooded	12	195	300	85	STD	15-1/2L x 7W x 14-5/8H	
8.683-064.0	AGM	12	234	518	125	STD	15-1/2L x 7W x 14-5/8H	185
8.663-290.0 BT-7	Flooded	6	220	383	105	STD	10-1/4L x 7-1/8W x 10-7/8H	
8.683-062.0	AGM	6	213	475	124	STD	10-1/4L x 7-1/8W x 10-7/8H	GC2 (T605)
8.663-290.0 BT-12	Flooded	12	95	145	39	STD	11-3/4L x 6-3/4W x 9-3/4H	
8.676-296.0	AGM	12	100	197	52	STD	11-3/4L x 6-3/4W x 9-3/4H	27



Battery Cable - Type A

GRACO# Old Graco#	Type	Color
8.682-769.0 BC421B	21"-4 Gauge	Black
8.682-770.0 BC421R	21"-4 Gauge	Red
8.682-771.0 BC425B	25"-4 Gauge	Black
8.682-772.0 BC452R	25"-4 Gauge	Red
8.682-773.0 BC436B	36"-4 Gauge	Black
8.682-774.0 BC436R	36"-4 Gauge	Red
8.682-776.0 BC446R	46"-4 Gauge	Red
8.682-775.0 BC446B	46"-4 Gauge	Black

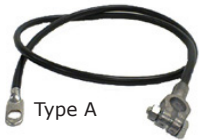

Type A

Battery Cable - Type B

GRACO# Old Graco#	Type	Color
8.682-783.0 BCS610	10"-6 Gauge	Red
8.682-784.0 BCS614	14"-6 Gauge	Red
8.682-785.0 BCS618	18"-6 Gauge	Red
8.682-786.0 BCS624	24"-6 Gauge	Red

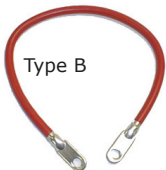

Type B

Battery Cable - Type C

GRACO# Old Graco#	Type	Color
8.682-787.0 BCSN410	10"-4 Gauge	Red
8.682-788.0 BCSN412	12"-4 Gauge	Red
8.682-789.0 BCSN415	15"-4 Gauge	Red
8.682-790.0 BCSN420	20"-4 Gauge	Red



Type C

Battery Terminals

GRACO# Old Graco#	Type
8.663-323.0 BT-710	Universal
8.663-342.0 BT-715	Marine-universal
8.683-071.0 BT-E4	Battery Terminal Ring Eyelet-4 AWG 3/8"
8.683-072.0 BT-E6	Battery Terminal Ring Eyelet-6 AWG 3/8"



Universal

Marine Universal

BT-E4

Bulk Battery Cables

GRACO#	Old Graco#	Gauge	Color
8.682-777.0	BCB-4R	100'-4	Red
8.682-778.0	BCB-4B	100'-4	Black
8.682-782.0	BCB-6R	100'-6	Red
8.682-281.0	BCB-6B	100'-6	Black



Battery Accessories



GRACO#/Old Graco# Type	Specifications
8.683-045.0 /BT-100 Hydrometer Glass	12" Glass 3 Color Scale: Empty, Half & Full Charge; Specific Gravity Readings from 1.100 to 1.300
8.683-046.0 /BT-101 Hydrometer Plastic	Dial Indicator Reveals Battery Charge & Specific Gravity
8.663-340.0 /BT-102 Battery Filler Bottle	2 Qt. w/Automatic Shut Off Nozzle
8.683-048.0 /BT-103 Terminal Lifter	Quality Forged Steel Construction
8.683-049.0 /BT-104 Post Cleaner	All Metal Construction, 2 PC. Internal and External Brushes
8.683-051.0 /BT-106 Top Post Terminal Protectors	Can of 100 With 3/4" Openings
8.683-052.0 /BT-107 Marine or Golf Car Terminal Protectors	Can of 100 With 5/16" Openings
8.683-053.0 /BT-108 Terminal Protection Spray	16 oz. Aerosol Can
8.671-962.0 /BT-111 Battery Load Tester	Milton 100 AMP 6/12 Volt Load Tester
8.683-056.0 /BT-112 Crimping Tool	Charger Plug Terminal Crimping Tool. Crimps up to 4/0
8.683-057.0 /BT-113 Terminal Cleaner Spray	16 oz Aerosol Can



Bearings



8.662-881.0



8.662-634.0



8.685-534.0



8.671-015.0



8.661-830.0



8.685-536.0



8.662-251.0

American-Lincoln

GRACO# Old Graco#	OEM	Description
8.685-534.0 WA-1-B	2-95-03087	Wheel Bearing
8.685-536.0 WA-1-SG	7-09-01007	Bearing Spanner

Breuer-Tornado

GRACO# Old Graco#	Type	Description
8.662-634.0 MC-23	2349	Bearing Assembly

Castex/Nobles

GRACO# Old Graco#	Type	Description
8.662-635.0 CB-9	205-004-402	Bearing
8.662-637.0 MC-1-B	140124	Bearing 6205 2RS/HT51 Wheel

Clarke

GRACO# OLD GRACO#	Type	Description
8.660-881.0 AD-B-1	902646, 902648 902679	Bearing
8.683-169.0 CB-10	902567 902653, 902512	Bearing
8.662-636.0 CB-11	902654	Bearing
8.672-654.0 CB-14	902660, 902658	Bearing (CM-12)
8.660-816.0 CFB-1	902713	5/8 Flange Bearing Assy
8.662-637.0 MC-1-B	902547	Bearing
8.684-316.0 MC-21	902714	Bearing
8.662-634.0 MC-23	902651 902550, 902298 902636, 902675	Bearing
8.685-534.0 WA-1-B	902704	Bearing for WC-3
8.685-536.0 WA-1-SG	897556	Spanner for Bearing (WC-3)

Minuteman

GRACO# Old Graco#	OEM	Description
8.662-634.0 MC-23	383551	Bearing
8.662-637.0 MC-1-B	832947	Bearing

Nilfisk/Advance

GRACO# Old Graco#	OEM	Description
8.660-881.0 AD-B-1	56228051 56203587 56202487	Bearing
8.662-637.0 MC-1-B	56154091	Bearing
8.662-634.0 MC-23	56372773 56479430	Bearing Bearing
8.660-251.0 NSS-B-1	56444308	Pillow Block Assy
8.685-534.0 WA-1-B	56365718	Bearing for WA-1
8.671-015.0 AD-B-3	56378267	Bearing
8.671-016.0 AD-B-4	56378259	Bearing Cone
8.661-830.0 WA-8	56362532	Flange Bearing 3/4x1-3/8 WA-8

NSS

GRACO# Old Graco#	OEM	Description
8.662-637.0 MC-1-B	27-031-1	Bearing
8.662-632.0 MC-9	10-992-1	Bearing
8.662-251.0 NSS-B-1	26-124-1	Pillow Block Assy

Tennant

GRACO# Old Graco#	OEM	Description
8.662-637.0 MC-1-B	140124	Bearing

Bearing Cross Reference

Bearing #	Description	GRACO#
608ZZ	Ball Bearing	8.660-881.0
L44643	Bearing	8.671-015.0
NTN4T-L44610	Bearing Cone	8.671-016.0
6002-2RS	Bearing	CB-9
6202-2RS	Bearing	8.683-169.0
6204-2RS	Bearing	8.661-636.0
6001-2RS	Bearing (CM-12)	8.672-654.0
SBLF-202-10	5/8 Flange bearing assy	8.660-816.0
6205-2RS	Bearing	8.662-637.0
6201-2RS-13MM	Bearing	8.662-632.0
99R12-ZZ	Bearing	8.684-316.0
6203-ZZ	Bearing	8.662-634.0
3/4x1-3/16x2	Bearing for WA-1	8.685-534.0



Belt Types

GRACO offers high quality belts in a wide variety of types and lengths to fit almost any machine. If you're not sure what belt you need to order, please see the guide below for help. If you need further assistance, please a contact Customer Service representative at 1-800-872-4472.



POLY V-BELT

Poly V belts have length-wise grooves, which optimize contact area, resulting in increased power transfer.
See page 85

Length	Width	# of Points	Belt#	GRACO#/Old Graco#
58"	9/16	6	58056	8.682-857.0/ BLC-34
55"	1-1/8	12	550512	8.682-799.0/ BLA-12
50-1/2"	15/16	10	510510	8.663-454.0/ BLA-4
45"	15/16	10	410510	8.682-851.0/ BLC-21
36"	15/16	10	360510	8.661-806.0/ BLA-70
30"	3/8	4	30054	8.682-874.0/ BLC-80
29"	15/16	10	290510	8.661-890.0/ BLA-5
24"	5/16	3	3PJ610	8.622-953.0
22"	9/16	6	22056	8.661-787.0/ BLA-1
21"	3/4	8	21058	8.682-802.0/ BLA-17
20"	9/16	6	20056	8.667-260.0/ BLA-14
18"	9/16	6	18056	8.661-786.0/ BLA-26
18"	3/8	4	18054	8.682-800.0/ BLA-13
15"	3/4	8	8PJ381	8.674-833.0



TIMING

Timing belts allow power transmission without slippage for maximum performance.
See page 83-84

Length	Width	Belt#	GRACO#/Old Graco#
34-1/2"	1	345L100Q	8.682-911.0/ BLT-1-S
22-1/2"	5/8	225L062	8.682-878.0/ BLCR-1
22-1/4"	1/4	9293-0508	8.663-315.0/ BLS-4
21-13/16"	1-1/2	218SL150	8.671-761.0/ BLA-2
21-13/16"	3/4	218SL075G	8.682-811.0/ BLA-3
21-13/16"	1/2	218SL050	8.661-835.0/ BLA-9
13"	1/4	130XL025U	8.682-917.0/ BLTT-3
13"	5/16	130XL031	8.686-656.0/ BLW-1
12"	1/4	120XL025	8.661-807.0/ BLA-72
10"	1/4	10XL025	8.682-818.0/ BLA-71



ROUND

Round belts use friction to stay in contact with pulleys and must be stretched or elongated to provide good driving friction. They are best used in light-to-medium duty power transmissions.
See page 85

Length	GRACO#/Old Graco#
4-1/8"	8.660-088.0/ BLE-3
3-9/16"	8.682-892.0/ BLH-2



V-BELT

V belts are the most widely used transmission belt. They are both economical to use and easy to replace.
See page 84

Length	Width	Thickness	Belt#	GRACO#/Old Graco#
76"	1/2	5/16	4L760	8.682-877.0/ BLC-9
69"	1/2	5/16	4I690	8.682-873.0/ BLC-8
56"	5/8	1/2 Notched	BX56	8.689-950.0/ BX-56
55"	5/8	1/2 Notched	BX55	8.683-075.0/ BX-55
53"	5/8	1/2 Notched	BX53	8.663-529.0/ BLE13
52"	5/8	1/2 Notched	BX52	8.663-528.0/ BLE-12
51"	5/8	1/2 Notched	BX51	8.663-526.0/ BLE-11
50"	5/8	1/2 Notched	BX50	8.664-393.0/ BX-50
49"	5/8	1/2	B49	8.663-532.0/ BLE-10
49"	3/8	7/32	3L490	8.661-722.0/ BLM-1
48"	5/8	1/2 Notched	BX48	8.663-531.0/ BLE-6
47-1/2"	3/8	5/16	34475	8.682-838.0/ BLAL-7
46"	1/2	5/16	4L460	8.682-860.0/ BLC-39
40"	5/8	1/2	B40	8.663-537.0/ BLE-9
38"	5/8	1/2 Notched	BX38	8.663-533.0/ BLE-5
38"	1/2	5/16	4L380	8.661-834.0/ BLA-28
36"	1/2	13/32	B36	8.671-146.0/ BLAL-16
35"	1/2	5/16	4L350	8.682-830.0/ BLAL-15
34"	21/32	3/8	5L340	8.682-902.0/ BLNS-1
33"	21/32	13/32	B33	8.663-464.0/ BLE-4
32"	21/32	13/32	B32	8.672-493.0/ BLE-2
31"	21/32	13/32	B31	8.682-880.0/ BLE-1
24"	3/8	7/32	3L240	8.682-833.0/ BLAL-2
23-5/8"	3/16	3/16	5M600	8.682-872.0/ BLC-78



Poly V Belts - Clarke

GRACO#/Old Graco#	OEM	FITS
8.661-955.0/ BLA-6	903016	CM-12
8.682-857.0/ BLC-34	903018	TB-20EL
8.682-874.0/ BLC-80	903769	580, 590

Poly V Belts - Minuteman

GRACO#/Old Graco#	OEM	FITS
8.668-775.0/ BLM-2	361006	Kleen Sweep 35

Poly V Belts - Nilfisk/Advance

GRACO# Old Graco#	OEM	FITS
8.663-454.0 BLA-4	56171200	Matador 17B, 20B World Buffer
8.682-802.0 BLA-17	56245608	Carpetron 28 (Late 18)
8.682-800.0 BLA-13	56320366	Carpetwin 14, 16 (Older)
8.667-260.0 BLA-14	56327476	Carpetwin 20, Carpetriever 28 (Old)
8.661-786.0 BLA-26	56331100	Carpetriever 22, 28 (New)
8.661-787.0 BLA-1	56372242	Convertamatic 24B, 26B
8.661-955.0 BLA-6	56378852	Convertamatic 38B
8.661-890.0 BLA-5	56378853	Convertamatic 32B
8.661-806.0 BLA-70	56392497	Convertamatic 325LX, 385LX
8.682-818.0 BLA-71	56324022	Convertamatic 200B, BD, LX
8.661-807.0 BLA-72	56392721	Convertamatic 285LX
8.674-933.0	9095820000	Micromax 20DC

Poly V Belts - Tennant

GRACO#/Old Graco#	OEM	FITS
8.664-768.0/ BLT-5	230507	Extractors
9.848-634.0	1016275	3610, Scout 24

IPC - Eagle

GRACO#/Old Graco#	OEM	FITS
9.848-634.0	MTCG00019	TK464

Round Belts - Clarke

GRACO#/Old Graco#	OEM	FITS
8.660-088.0/ BLE-3	903340	200, 300

Round Belts - Nilfisk/Advance

GRACO#/Old Graco#	OEM	FITS
8.660-088.0/ BLE-3	56630563 703456	AdVac, SelectVac
8.682-892.0/ BLH-2	56703010	1200 Vac

Round Belts - Miscellaneous

GRACO# Old Graco#	OEM	FITS
8.660-088.0 BLE-3	30563A	Eureka - Sanitaire, Kent, Advance
8.660-088.0 BLE-3	10159	Breuer Tornado
8.681-637.0 BLE-3M	30563A	Eureka Manufacturer Original
8.682-892.0 BLH-2	49258	Hoover

Timing Belts - Breuer-Tornado

GRACO# Old Graco#	OEM	FITS
8.682-911.0 BLT-1-S	18418	9300 Midrange, 9400 H Series

Timing Belts - Castex/Nobles

GRACO# Old Graco#	OEM	FITS
8.682-917.0 BLTT-3	577-225-000	CV141



Timing Belts - Clarke

GRACO# Old Graco#	OEM	FITS
8.682-811.0 BLA-3	903260	DU-8

Timing Belts - Nilfisk/Advance

GRACO# Old Graco#	OEM	FITS
8.682-811.0 BLA-3	56154245	Pacemaker; Convertamatics
8.671-761.0 BLA-2	56154288	Pacemaker; Convertamatics
8.661-835.0 BLA-9	56158399	Pacemaker 15

Timing Belts - Miscellaneous

GRACO# Old Graco#	OEM	FITS
8.682-917.0 BLTT-3	301434	Mastercraft TM-14
8.686-656.0 BLW-1	2049	Windsor Versamatic 14, 18
8.686-656.0 BLW-1	4024	Windsor Versamatic 14, 18

V Belts - American-Lincoln

GRACO# Old Graco#	OEM	FITS
8.661-834.0 BLAL-27	2-00-01046	7000
8.682-830.0 BLAL-15	2-00-01062	8" Sander
8.671-146.0 BLAL-16	2-00-01063	8" Sander
8.682-833.0 BLAL-2	2-00-03536	721, 726, 730, 930

V Belts - Clarke

GRACO# Old Graco#	OEM	FITS
8.682-872.0 BLC-78	903042	575, 578
8.682-860.0 BLC-39	903400	1000 DCR
8.682-854.0 BLC-28	903540	Drive belt (SPS-28)
8.682-877.0 BLC-9	903975	TB32 (Right)
8.682-873.0 BLC-8	903976	TB32 (Left)

V Belts - Nilfisk/Advance

GRACO# Old Graco#	OEM	FITS
8.661-834.0 BLA-28	56390607	Convertamatic 32B,38B



8.682-880.0

V Belts - Miscellaneous

GRACO# Old Graco#	OEM	FITS
8.671-146.0 BLAL-16	B-36	Pioneer Eclipse
8.682-880.0 BLE-1	B-31	Pioneer Eclipse
8.672-493.0 BLE-2	B-32	Pioneer Eclipse
8.663-464.0 BLE-4	B-33	Pioneer Eclipse
8.663-533.0 BLE-5	BX38	Various Propane Burnishers
8.663-531.0 BLE-6	BX48	Various Propane Burnishers
8.663-537.0 BLE-9	B-40	Various Propane Burnishers
8.663-532.0 BLE-10	B-49	Various Propane Burnishers
8.663-526.0 BLE-11	BX51	Various Propane Burnishers
8.663-528.0 BLE-12	BX52	Various Propane Burnishers
8.663-529.0 BLE-13	BX53	Various Propane Burnishers
8.661-722.0 BLM-1	DB-1	Mercury High Speed Buffer
8.664-393.0 BX-50	BX50	Various Propane Burnishers
8.683-075.0 BX-55	BX55	Various Propane Burnishers

MISC

GRACO# Old Graco#	OEM	FITS
8.663-315.0 BLS-4	3723	Steamex 870/1190/MX-21

Graco Manufacturing Helps You Save Time And Money With Our Industrial Brush Line.

Cylindrical Sweeping Brushes (Main Brooms)

Our main brooms are designed for maximum performance. Built with the highest quality bristle materials, staple set to heavy duty precision extruded cores.

A variety of bristle materials and patterns are available to meet different sweeping conditions.

6 and 8 Double Row (Low Density) – are best for general purpose sweeping. Spacing between the rows allow for the pick up of bulkier litter.

- Nylon – 6 or 8 row design – a great choice for most litter and surface conditions. Longest lasting and good hopper loading – medium dust conditions – OK for high temperatures - not for wet conditions.
- Polypropylene – 6 or 8 row design – a good economical selection for most litter and surface conditions. Good brush life – for medium dust conditions – retains stiffness when wet – not for higher temperature debris.
- Polypropylene and Wire – 6 or 8 row design – stiff poly bristles for loading debris and wire to loosen encrusted dirt - for light dust conditions - retains stiffness when wet – not for higher temperature debris.
- Crinkle Wire – 6 or 8 row design – used when aggressively sweeping heavy compacted dirt. Recommended for dry, low dust sweeping – OK for high temperatures.
- Fiber and Wire – 6 or 8 row design – combines fiber for light to moderate dust conditions with wire for loosening lightly compacted dirt and better hopper loading.
- Nylon Patrol design – excellent brush life – the “V” shaped pattern is for sweeping large area at high speeds – superior hopper loading - not for wet sweeping.
- Proex – 6 or 8 row design – this blended polypropylene brush is an excellent choice for all purpose sweeping. Retains stiffness in wet conditions – not for high temperature sweeping – good for picking up paper, sand, gravel and lighter less bulky litter.
- Proex and Wire – 6 or 8 row design – more aggressive sweeping than Proex – with wire added for loosening compacted dirt and loading of heavier debris.
- Union Mix (Natural Fiber) – 6 or 8 row design – this natural fiber material is used for dust and smaller light debris. Not recommend for wet applications.
- Polypropylene Sand Wedge design – this intense zigzag wedge pattern is for picking up fine debris. Poly remains stiff in wet conditions.

18 and 24 Single Row (High Density – Full Fill) – the choice for fine heavy dust conditions, including sand and minimal light debris.

- Nylon – 18 or 24 Single Row – long lasting nylon - excellent choice for severe dry dust conditions – ideal for rough surfaces – not for wet sweeping.
- Fiber and Wire – 18 or 24 Single Row – dense natural fiber for heavy dust conditions – with wire added for loosening light compacted dirt.

Extending Main Broom Life & Maximizing Performance

To lengthen brush life, rotate the main broom, end to end, after 20 hours of operation. This prevents the bristles from becoming set or worn in one direction. Only operate the brush in the full down or floating position on very uneven floors. Doing so leads to premature bristle wear.

For even bristle wear and proper performance, periodically test the brush pattern for proper adjustment.

This is done by making or burning a pattern on the floor or pavement. With the machine stopped, lower the rotating main broom for about 30 seconds. Without moving the machine, raise the brush and move the machine. When properly adjusted the pattern should be rectangular and 2”-2.5” wide.

A thinner pattern doesn't allow enough bristle contact for flicking debris into the hopper and uneven surfaces. A wider pattern leads to premature bristle wear.

Properly Adjusted Main Broom

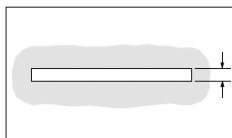

Improper Main Broom Pattern

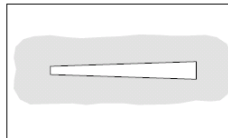

Side Sweeping Brushes

Made in a variety of diameters to meet OEM specifications, our side brooms are made using long lasting quality materials.

- Polypropylene – most commonly used economical material for general purpose sweeping. Retains its stiffness when wet – not for high temperature debris
- Nylon – same sweeping characteristics as poly – longer lasting – not for wet sweeping
- Flat Wire – for outdoor heavy duty sweeping of high temperature debris, wet mud and compacted materials

Extending Side Brush Life & Maximizing Performance

The purpose of side brush is to move debris away from a curb, wall or structure, so it can be picked up by the main broom. To prevent debris from being moved away from the machine and premature brush wear, the side brush should be properly adjusted.

The illustration below depicts the ideal brush angle for proper contact with the floor.

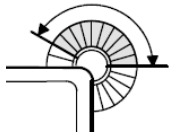

Cylindrical Scrub Brushes/Rotary Scrub Brushes

Graco cylindrical and circular rotary brushes were designed to meet or exceed the specifications of the OEM, for fit and performance. We offer a wide spectrum of bristle materials, suited for light duty through heavy aggressive scrubbing requirements. The number of rows (12, 14, 18, 20, and 24) vary by brush and OEM standards.

Our top quality rotary brushes come with clutch plates or mounting hardware. Full fill pattern offers contact on uneven floors.

- Polypropylene – economical choice for general purpose light to medium duty aggression.
- Stiff Polypropylene – a more aggressive alternative to poly.
- Nylon – longer lasting than poly, a good choice for general purpose light to moderate scrubbing.
- Prolene – polypropylene material for medium-duty scrubbing. Used on concrete, terrazzo and vinyl tile.
- Grit – silicone carbide particles impregnated in each bristle for mild to very aggressive scrubbing – long lasting
 - 46 Grit for the most aggressive scrubbing of concrete, terrazzo
 - 80 Grit for moderate to aggressive scrubbing of concrete, terrazzo, and quarry tile
 - 180 Grit for lighter to moderate scrubbing of concrete, terrazzo, quarry tile, vinyl
 - 240 Grit for general cleaning of concrete, terrazzo, and quarry tile
 - 500 Grit very light scrubbing of terrazzo, quarry tile, marble, vinyl tile, rubber floors
- Polyester – very long lasting high quality brush for general duty scrubbing – suitable for painted or epoxy coated floors

Extending Cylindrical Brush Life & Maximizing Performance

For even bristle wear and proper performance, periodically test the brush pattern for proper adjustment. This is done by making or burning a pattern on the floor or pavement. With the machine stopped, lower the rotating scrub brushes for about 30 seconds. Without moving the machine, raise the brushes and move the machine. If the pattern is even across the brush width, the brushes are adjusted properly.

When rotating cylindrical scrub brushes, rotate the front brush to the rear. They can be flipped end to end as well.

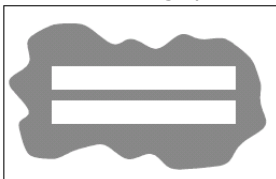

Short-Trim Pad Drivers

Our short-trim pad drivers are made with shower feed molded plastic blocks and stiff poly bristle fill. Staggered bristle length grips the pad, while center-lock pad holders are included, for excellent pad gripping performance.



Brushes



88055570



88055620



88055880



88056140



88056280



88056320



88056550



88056890



88056900



88057010

Brushes

Advance American-Lincoln

GRACO#/Old Graco#	OEM	Description	Fits
88055550	33017255	BROOM, SIDE POLY	Protterra
88055590	33018856	BROOM, MAIN NYLON SPIRAL	Protterra
88055600	33018857	BROOM, MAIN POLY WHITE/NAVY	Protterra
88055580	33018858	BROOM, MAIN POLY/STEEL	Protterra
88055610	33018859	BROOM, MAIN UNION MIX SPIRAL	Protterra
88055560	33018889	BROOM, SIDE POLY/STEEL	Protterra
88055570	33018890	BROOM, SIDE NYLON	Protterra
88068960	56110011	BRUSH CYL 48 PROLENE	Condor XL
88068970	56110012	80 GRIT	Condor XL
88056900	56110013	BRUSH 48" 180 MIDLITE	Condor XL
88068980	56407476	BRUSH, MIDLITE GRIT 180, 32"	Adgressor, 3200, SC750, SC800
88068990	56407477	BRUSH, DYNA GRIT 80, 32"	Adgressor, 3200, SC750, SC800
88068940	56412193	MidLite Grit 180 28"	Advenger 28, SC750, SC800
88068950	56412194	Dyna Grit 80 28"	Advenger 28, SC750, SC800
88057030	56413056	BROOM, SIDE	Condor
88057200	56413113	BRUSH, SOFT NYLON 40"	Condor 40" Cyl
88057210	56413114	BRUSH, HARD NYLON 40"	Condor 40" Cyl
88056980	56413115	BRUSH 40" 180 GRIT	Condor 40" Cyl
88057220	56413116	BRUSH, 80 GRIT 40"	Condor 40" Cyl
88056970	56413118	BRUSH 40" PROLENE	Condor 40" Cyl
88057260	56413352	BRUSH, SOFT NYLON 48"	Condor 48" Cyl
88057270	56413353	BRUSH, HARD NYLON 48"	Condor 48" Cyl
88057020	56413354	BRUSH 48" 180 GRIT	Condor 48" Cyl
88057280	56413355	BRUSH, 80 GRIT 48"	Condor 48" Cyl
88057010	56413357	BRUSH 48" POLY	Condor 48" Cyl
88057230	56413434	BRUSH, SOFT NYLON 45"	Condor 45" Cyl
88057240	56413435	BRUSH, HARD NYLON 45"	Condor 45" Cyl
88057000	56413436	BRUSH 45" 180 GRIT	Condor 45" Cyl
88057250	56413437	BRUSH, 80 GRIT 45"	Condor 45" Cyl
88056990	56413439	BRUSH 45" POLY	Condor 45" Cyl
88056270	56462252	BROOM, SIDE POLY	Captor 4300
88056410	56505780	PAD DRIVER ASSY-17" SHORT TRIM	Captor 4800
88056430	56505781	BRUSH-17" MAGNA GRIT 46	Captor 4800, Condor 48" Disc, BR855
88056390	56505782	BRUSH-17" DYNA GRIT 80	Captor 4800, Condor 48" Disc, BR855



Advance American-Lincoln (con't)

GRACO#/Old Graco#	OEM	Description	Fits
88056450	56505783	BRUSH-17" AGLITE GRIT 500	Captor 4800, Condor 48" Disc, BR855
88056380	56505784	BRUSH-17" PROLENE	Captor 4800
88056420	56505785	BRUSH-17"PROLITE	Captor 4800, Condor 48" Disc, BR855
88056370	56505786	BRUSH-17" UNION MIX	Captor 4800, Condor 48" Disc, BR855
88056400	56505787	BRUSH-17" MIDGRIT 120	Captor 4800, Condor 48" Disc, BR855
88056440	56505788	BRUSH-17" MIDLITE GRIT 180	Captor 4800
88056910	56505790	PAD DRIVER ASSY-20" SHORT TRIM	Condor40" Disk, Lynx 385, Convertamatic 38, Hydro-Retreiver 3800
88057080	56505791	DISC BRUSH-20" MAGNAGRIT	Condor40" Disk, Lynx 385, Convertamatic 38, Hydro-Retreiver 3800
88057090	56505792	DISC BRUSH-20" DYNAGRIT	Condor40" Disk, Lynx 385, Convertamatic 38, Hydro-Retreiver 3800
88057100	56505793	DISC BRUSH-20" AGLITE	Condor40" Disk, Lynx 385, Convertamatic 38, Hydro-Retreiver 3800
88056920	56505794	DISC BRUSH-20" PROLENE	Condor40" Disk, Lynx 385, Convertamatic 38, Hydro-Retreiver 3800
88057110	56505795	DISC BRUSH-20" PROLITE	Condor40" Disk, Lynx 385, Convertamatic 38, Hydro-Retreiver 3800
88057120	56505796	DISC BRUSH-20" UNION MIX	Condor40" Disk, Lynx 385, Convertamatic 38, Hydro-Retreiver 3800
88056930	56505797	DISC BRUSH-20" MIDGRIT	Condor40" Disk, Lynx 385, Convertamatic 38, Hydro-Retreiver 3800
88057130	56505798	DISC BRUSH-20" MIDLITE GRIT	Condor40" Disk, Lynx 385, Convertamatic 38, Hydro-Retreiver 3800
88056500	56505800	PAD DRIVER ASSY-14" SHORT TRIM	Captor 5400, BR755, Convertamatic 28", Advenger 28"
88056520	56505801	BRUSH-14" MAGNA GRIT 46	Captor 5400, BR755, Convertamatic 28", Advenger 28"
88056480	56505802	BRUSH-14" DYNA GRIT 80	Captor 5400, BR755, Convertamatic 28", Advenger 28"
88056540	56505803	BRUSH-14" AGLITE GRIT 500	Captor 5400, BR755, Convertamatic 28", Advenger 28"
88056470	56505804	BRUSH-14" PROLENE	Captor 5400
88056510	56505805	BRUSH-14"PROLITE	Captor 5400, BR755, Convertamatic 28", Advenger 28"
88056460	56505806	BRUSH-14" UNION MIX	Captor 5400, BR755, Convertamatic 28", Advenger 28"
88056490	56505807	BRUSH-14" MIDGRIT 240	Captor 5400
88056530	56505808	BRUSH-14" MIDLITE GRIT 180	Captor 5400, BR755, Convertamatic 28", Advenger 28"
88056940	56505830	PAD DRIVER ASSY-16" SHORT TRIM	Condor45" Disk, Convertamatic 32", Warrior ST 32D, Adgressor 3220D
88057140	56505831	DISC BRUSH-16" MAGNAGRIT	Condor45" Disk, Convertamatic 32", Warrior ST 32D, Adgressor 3220D
88057150	56505832	DISC BRUSH-16" DYNAGRIT	Condor45" Disk, Convertamatic 32", Warrior ST 32D, Adgressor 3220D
88057160	56505833	DISC BRUSH-16" AGLITE	Condor45" Disk, Convertamatic 32", Warrior ST 32D, Adgressor 3220D
88056950	56505834	DISC BRUSH-16" PROLENE	Condor45" Disk, Convertamatic 32", Warrior ST 32D, Adgressor 3220D
88057170	56505835	DISC BRUSH-16" PROLITE	Condor45" Disk, Convertamatic 32", Warrior ST 32D, Adgressor 3220D
88057180	56505836	DISC BRUSH-16" UNION MIX	Condor45" Disk, Convertamatic 32", Warrior ST 32D, Adgressor 3220D
88056960	56505837	DISC BRUSH-16" MIDGRIT	Condor45" Disk, Convertamatic 32", Warrior ST 32D, Adgressor 3220D
88057190	56505838	DISC BRUSH-16" MIDLITE GRIT	Condor45" Disk, Convertamatic 32", Warrior ST 32D, Adgressor 3220D



Advance American-Lincoln (con't)

GRACO#/Old Graco#	OEM	Description	Fits
88056320	56505940	PAD DRIVER ASSY-15" SHORT TRIM	Captor 4300
88056340	56505941	BRUSH-15" MAGNA GRIT 46	Captor 4300
88056300	56505942	BRUSH-15" DYNA GRIT 80	Captor 4300
88056360	56505943	BRUSH-15" AGLITE GRIT 500	Captor 4300
88056290	56505944	BRUSH-15" PROLENE	Captor 4300
88056330	56505945	BRUSH-15"PROLITE	Captor 4300
88056280	56505946	BRUSH-15" UNION MIX	Captor 4300
88056310	56505947	BRUSH-15" MID GRIT 120	Captor 4300
88056350	56505948	BRUSH-15" MIDLITE GRIT 180	Captor 4300
88056260	56505951	Broom,Main Poly/Wire,8 Double Rows	CR1100, CR1200, C1400, Captor 4300, CAPTOR 4800, CAPTOR 5400
88056230	56505953	BROOM,MAIN NYLON,8 DOUBLE ROWS	CR1100, CR1200, C1400, Captor 4300, CAPTOR 4800, CAPTOR 5400
88056250	56505954	BROOM,MAIN PROEX,8 DOUBLE ROWS	CR1100, CR1200, C1400, Captor 4300, CAPTOR 4800, CAPTOR 5400
88056210	56505955	Broom,Main Proex/Wire,8 Double Rows	Captor 4300
88056220	56505956	Broom,Main Prolene,8 Double Rows	CR1100, CR1200, C1400, Captor 4300, CAPTOR 4800, CAPTOR 5400
88055850	56507340	BROOM, MAIN PROEX-WIRE (CHEVRON)	Exterra, SR1900
88055880	56507341	Broom, Main Proex, 12 Double Rows	Exterra, SR1900
88055860	56507342	Broom,Main Proex-Wire,12 Double Rows	Exterra, SR1900
88055910	56507343	BROOM, MAIN POLY,8 DOUBLE ROWS	Exterra, SR1900
88055900	56507344	Broom, Main Poly/Wire,12 Double Rows	Exterra, SR1900
88055870	56507345	BROOM, MAIN NYLON,8 DOUBLE ROWS	Exterra, SR1900
88055890	56507346	BROOM, MAIN PROEX, 8 DOUBLE ROWS	Exterra, SR1900
88055920	56507350	BROOM, SIDE, POLY	Exterra
88055930	56507351	BROOM, SIDE, NYLON 30DEG.	Exterra, SR1900
88055940	56507352	BROOM, SIDE, WIRE 30DEG.	Exterra, SR1900
88055840	56507424	BROOM, MAIN PROEX-WIRE	Exterra
88055950	56508498	BROOM, SIDE, POLY 41 DEG.	Exterra, SR1900
88055960	56508499	BROOM, SIDE, NYLON 41 DEG.	Exterra, SR1900
88055700	1451899000	BROOM, SIDE POLY	Terra 3700B
88055730	1454879000	BROOM, MAIN STD	Terra 4300B
88055710	1454959000	BROOM, SIDE STEEL MIX	Terra 3700B
88055800	1454963000	BROOM, MAIN	Terra 5200B
88055720	1454976000	BROOM, SIDE NATURAL FIBER	Terra 3700B
88055750	1456080000	BROOM, MAIN NATURAL FIBRE	Terra 4300B
88055790	1456135000	BROOM, MAIN	Terra 5200B
88055690	1460678000	BROOM, SIDE NYLON STD.	Terra 3700B
88055660	1460748000	BROOM, MAIN POLY	Terra 3700B
88055680	1460749000	BROOM, MAIN NATURAL FIBER	Terra 3700B
88055670	1460750000	BROOM, MAIN STEEL MIX	Terra 3700B
88055640	1460751000	BROOM, MAIN POLY	Terra 3700B
88055620	1460752000	BROOM, MAIN NYLON STD.	Terra 3700B
88055630	1460753000	BROOM, MAIN NATURAL FIBER	Terra 3700B
88055650	1460754000	BROOM, MAIN STEEL MIX	Terra 3700B
88055780	1461018000	BROOM, MAIN POLY	Terra 5200B
88055810	1461025000	BROOM, SIDE	Terra 5200B
88055820	1461148000	BROOM, SIDE	Terra 5200B
88055830	1461149000	BROOM, SIDE	Terra 5200B
88056160	0765-256	BRUSH ASSY. BLACK NYLON 16"	7730-46", CR1000XL
88056170	0765-257	BRUSH ASSY. POLY 16" (AMERFIL)	7730-46"



Advance American-Lincoln (con't)

GRACO#/Old Graco#	OEM	Description	Fits
88056180	0765-258	BRUSH ASSY. SUPER GRIT 16"	7730-46", CR1000XL
88056190	0765-265	BRUSH ASSY. CLEANGRIT 16"	7730-46", CR1000XL
88056110	0765-271	BRUSH ASSY. BLACK NYLON	7730-40", CR1000
88056120	0765-272	BRUSH ASSY-POLYPROPYLENE	7730-40"
88056130	0765-273	BRUSH ASSY-SUPERGRIT	7730-40", CR1000
88056140	0765-274	BRUSH ASSY-CLEANGRIT	7730-40", CR1000
88056200	0780-434	PAD DRIVER ASSY.16"	7730-46", CR1000XL
88056150	0780-497	PAD DRIVER ASSY. 20"	7730-40", CR1000
88057050	7-08-03170-1	DISC BRUSH ASSY. BLACK NYLON	7765
88056880	7-08-03172-1	DISK BRUSH ASSY. POLY	7765
88056890	7-08-03205-1	DISK BRUSH ASSY. SUPER GRIT	7765
88057070	7-08-03262-1	DISC BRUSH ASSY. SOFT NYLON	7765
88057060	7-08-03269	DISC BRUSH ASSY. CLEAN GRIT	7765
88056090	7-08-03313	BROOM,MAIN FIBRE/WIRE	7730, CR1000, CR1000XL
88056600	8-08-03107	BROOM, SIDE POLY	7765
88056060	8-08-03137	BROOM,MAIN PROEX,6 DOUBLE ROWS	7730
88056080	8-08-03142	BROOM,MAIN NYLON,6 DOUBLE ROWS	7730, CR1000, CR1000XL
88056610	8-08-03177	BROOM, SIDE NYLON	7765
88056550	8-08-03180	Broom, Main Proex/Wire 8 Double Rows	7765
88056570	8-08-03190	BROOM, MAIN PROEX 8 DOUBLE ROWS	7765
88056560	8-08-03193	BROOM, NYLON 8 DOUBLE ROWS	7765
88056590	8-08-03200	BROOM, MAIN POLY 8 DOUBLE ROWS	7765
88055970	8-08-03202	Broom,Main Proex-Wire,8 Double Rows	Granterra
88055990	8-08-03204	BROOM,MAIN PROEX,8 DOUBLE ROWS	Granterra, 4366XP, 3366XP, SR2000
88056020	8-08-03209	BROOM,MAIN POLY,8 DOUBLE ROWS	Granterra, 4366XP, 3366XP, SR2000
88056030	8-08-03211	BROOM,SIDE NYLON	Granterra
88056040	8-08-03212	BROOM,SIDE POLY	Granterra
88056010	8-08-03214	BROOM,POLY/WIRE,8 DOUBLE ROWS	Granterra
88056100	8-08-03215	BROOM, SIDE POLY	7730

Advance American-Lincoln by Machine

GRACO#/Old Graco#	OEM	Description
Fits 7730		
8.805-616.0	0765-256	BRUSH ASSY. BLACK NYLON 16"
8.805-618.0	0765-258	BRUSH ASSY. SUPER GRIT 16"
8.805-619.0	0765-265	BRUSH ASSY. CLEANGRIT 16"
8.805-611.0	0765-271	BRUSH ASSY. BLACK NYLON
8.805-613.0	0765-273	BRUSH ASSY-SUPERGRIT
8.805-614.0	0765-274	BRUSH ASSY-CLEANGRIT
8.805-620.0	0780-434	PAD DRIVER ASSY.16"
8.805-615.0	0780-497	PAD DRIVER ASSY. 20"
8.805-609.0	7-08-03313	BROOM,MAIN FIBRE/WIRE
8.805-606.0	8-08-03137	BROOM,MAIN PROEX,6 DOUBLE ROWS
8.805-608.0	8-08-03142	BROOM,MAIN NYLON,6 DOUBLE ROWS
8.805-610.0	8-08-03215	BROOM, SIDE POLY



Advance American-Lincoln by Machine (con't)

GRACO#/Old Graco#	OEM	Description
Fits 7765		
8.805-705.0	7-08-03170-1	DISC BRUSH ASSY. BLACK NYLON
8.805-688.0	7-08-03172-1	DISK BRUSH ASSY. POLY
8.805-689.0	7-08-03205-1	DISK BRUSH ASSY. SUPER GRIT
8.805-707.0	7-08-03262-1	DISC BRUSH ASSY. SOFT NYLON
8.805-706.0	7-08-03269	DISC BRUSH ASSY. CLEAN GRIT
8.805-660.0	8-08-03107	BROOM, SIDE POLY
8.805-661.0	8-08-03177	BROOM, SIDE NYLON
8.805-655.0	8-08-03180	BROOM, MAIN PROEX/WIRE 8 DOUBLE ROWS
8.805-657.0	8-08-03190	BROOM, MAIN PROEX 8 DOUBLE ROWS
8.805-656.0	8-08-03193	BROOM, NYLON 8 DOUBLE ROWS
8.805-659.0	8-08-03200	BROOM, MAIN POLY 8 DOUBLE ROWS
Fits 3366XP		
8.805-599.0	8-08-03204	BROOM,MAIN PROEX,8 DOUBLE ROWS
8.805-602.0	8-08-03209	BROOM,MAIN POLY,8 DOUBLE ROWS
Fits 4366XP		
8.805-599.0	8-08-03204	BROOM,MAIN PROEX,8 DOUBLE ROWS
8.805-602.0	8-08-03209	BROOM,MAIN POLY,8 DOUBLE ROWS
Fits 7730 40", 46"		
8.805-612.0	0765-272	BRUSH ASSY-POLYPROPYLENE - 40"
8.805-617.0	0765-257	BRUSH ASSY. POLY 16" (46")
Fits Adgressor 3220D		
8.805-694.0	56505830	PAD DRIVER ASSY-16" SHORT TRIM
8.805-695.0	56505834	DISC BRUSH-16" PROLENE
8.805-696.0	56505837	DISC BRUSH-16" MIDGRIT
Fits Advenger		
8.805-650.0	56505800	PAD DRIVER ASSY-14" SHORT TRIM
8.805-652.0	56505801	BRUSH-14" MAGNA GRIT 46
8.805-648.0	56505802	BRUSH-14" DYNA GRIT 80
8.805-654.0	56505803	BRUSH-14" AGLITE GRIT 500
8.805-651.0	56505805	BRUSH-14"PROLITE
8.805-646.0	56505806	BRUSH-14" UNION MIX
Fits Advenger 28		
8.806-694.0	56412193	BRUSH 180 GRIT 28"
8.806-695.0	56412194	BRUSH, DYNA GRIT 80, 28"
8.805-653.0	565058080	BRUSH-14" MIDLITE GRIT 180
Fits Advenger 32		
8.806-698.0	56407476	BRUSH, MIDLITE GRIT 180, 32"



Advance American-Lincoln by Machine (con't)

GRACO#/Old Graco#	OEM	Description
Fits BR755		
8.805-650.0	56505800	PAD DRIVER ASSY-14" SHORT TRIM
8.805-652.0	56505801	BRUSH-14" MAGNA GRIT 46
8.805-648.0	56505802	BRUSH-14" DYNA GRIT 80
8.805-654.0	56505803	BRUSH-14" AGLITE GRIT 500
8.805-651.0	56505805	BRUSH-14"PROLITE
8.805-646.0	56505806	BRUSH-14" UNION MIX
8.805-653.0	565058080	BRUSH-14" MIDLITE GRIT 180
Fits BR855		
8.805-643.0	56505781	BRUSH-17" MAGNA GRIT 46
8.805-639.0	56505782	BRUSH-17" DYNA GRIT 80
8.805-645.0	56505783	BRUSH-17" AGLITE GRIT 500
8.805-642.0	56505785	BRUSH-17"PROLITE
8.805-637.0	56505786	BRUSH-17" UNION MIX
8.805-640.0	56505787	BRUSH-17" MIDGRIT 240
Fits C1400		
8.805-626.0	56505951	BROOM,MAIN POLY/WIRE,8 DOUBLE ROWS
8.805-623.0	56505953	BROOM,MAIN NYLON,8 DOUBLE ROWS
8.805-625.0	56505954	BROOM,MAIN PROEX,8 DOUBLE ROWS
8.805-622.0	56505956	BROOM,MAIN PROLENE,8 DOUBLE ROWS
Fits Captor 4300		
8.805-627.0	56462252	BROOM,SIDE POLY
8.805-632.0	56505940	PAD DRIVER ASSY-15" SHORT TRIM
8.805-634.0	56505941	BRUSH-15" MAGNA GRIT 46
8.805-630.0	56505942	BRUSH-15" DYNA GRIT 80
8.805-636.0	56505943	BRUSH-15" AGLITE GRIT 500
8.805-629.0	56505944	BRUSH-15" PROLENE
8.805-633.0	56505945	BRUSH-15" PROLITE
8.805-628.0	56505946	BRUSH-15" UNION MIX
8.805-631.0	56505947	BRUSH-15" MID GRIT 240
8.805-635.0	56505948	BRUSH-15" MIDLITE GRIT 180
8.805-626.0	56505951	BROOM,MAIN POLY/WIRE,8 DOUBLE ROWS
8.805-623.0	56505953	BROOM,MAIN NYLON,8 DOUBLE ROWS
8.805-625.0	56505954	BROOM,MAIN PROEX,8 DOUBLE ROWS
8.805-621.0	56505955	BROOM,MAIN PROEX/WIRE,8 DOUBLE ROWS
8.805-622.0	56505956	BROOM,MAIN PROLENE,8 DOUBLE ROWS
Fits Captor 4800		
8.805-641.0	56505780	PAD DRIVER ASSY-17" SHORT TRIM
8.805-643.0	56505781	BRUSH-17" MAGNA GRIT 46
8.805-639.0	56505782	BRUSH-17" DYNA GRIT 80
8.805-645.0	56505783	BRUSH-17" AGLITE GRIT 500
8.805-638.0	56505784	BRUSH-17" PROLENE
8.805-642.0	56505785	BRUSH-17"PROLITE
8.805-637.0	56505786	BRUSH-17" UNION MIX
8.805-640.0	56505787	BRUSH-17" MIDGRIT 240
8.805-644.0	56505788	BRUSH-17" MIDLITE GRIT 180
8.805-626.0	56505951	BROOM,MAIN POLY/WIRE,8 DOUBLE ROWS



Advance American-Lincoln by Machine (con't)

GRACO#/Old Graco#	OEM	Description
Fits Captor 4800 (con't)		
8.805-623.0	56505953	BROOM,MAIN NYLON,8 DOUBLE ROWS
8.805-625.0	56505954	BROOM,MAIN PROEX,8 DOUBLE ROWS
8.805-622.0	56505956	BROOM,MAIN PROLENE,8 DOUBLE ROWS
Fits Captor 5400		
8.805-650.0	56505800	PAD DRIVER ASSY-14" SHORT TRIM
8.805-652.0	56505801	BRUSH-14" MAGNA GRIT 46
8.805-648.0	56505802	BRUSH-14" DYNA GRIT 80
8.805-654.0	56505803	BRUSH-14" AGLITE GRIT 500
8.805-647.0	56505804	BRUSH-14" PROLENE
8.805-651.0	56505805	BRUSH-14"PROLITE
8.805-646.0	56505806	BRUSH-14" UNION MIX
8.805-649.0	56505807	BRUSH-14" MIDGRIT 240
8.805-626.0	56505951	BROOM,MAIN POLY/WIRE,8 DOUBLE ROWS
8.805-623.0	56505953	BROOM,MAIN NYLON,8 DOUBLE ROWS
8.805-625.0	56505954	BROOM,MAIN PROEX,8 DOUBLE ROWS
8.805-622.0	56505956	BROOM,MAIN PROLENE,8 DOUBLE ROWS
8.805-653.0	565058080	BRUSH-14" MIDLITE GRIT 180
Fits CMAX 34ST		
8.806-698.0	56407476	BRUSH, MIDLITE GRIT 180, 32"
Fits Condor		
8.805-703.0	56413056	BROOM, SIDE
8.805-720.0	56413113	BRUSH, SOFT NYLON 40"
8.805-721.0	56413114	BRUSH, HARD NYLON 40"
8.805-722.0	56413116	BRUSH, 80 GRIT 40"
8.805-726.0	56413352	BRUSH, SOFT NYLON 48"
8.805-727.0	56413353	BRUSH, HARD NYLON 48"
8.805-728.0	56413355	BRUSH, 80 GRIT 48"
8.805-723.0	56413434	BRUSH, SOFT NYLON 45"
8.805-724.0	56413435	BRUSH, HARD NYLON 45"
8.805-725.0	56413437	BRUSH, 80 GRIT 45"
8.805-643.0	56505781	BRUSH-17" MAGNA GRIT 46
8.805-639.0	56505782	BRUSH-17" DYNA GRIT 80
8.805-645.0	56505783	BRUSH-17" AGLITE GRIT 500
8.805-642.0	56505785	BRUSH-17"PROLITE
8.805-637.0	56505786	BRUSH-17" UNION MIX
8.805-640.0	56505787	BRUSH-17" MIDGRIT 240
8.805-708.0	56505791	DISC BRUSH-20" MAGNAGRIT
8.805-709.0	56505792	DISC BRUSH-20" DYNAGRIT
8.805-710.0	56505793	DISC BRUSH-20" AGLITE
8.805-711.0	56505795	DISC BRUSH-20" PROLITE
8.805-712.0	56505796	DISC BRUSH-20" UNION MIX
8.805-713.0	56505798	DISC BRUSH-20" MIDLITE GRIT
8.805-714.0	56505831	DISC BRUSH-16" MAGNAGRIT
8.805-715.0	56505832	DISC BRUSH-16" DYNAGRIT
8.805-716.0	56505833	DISC BRUSH-16" AGLITE
8.805-717.0	56505835	DISC BRUSH-16" PROLITE



Advance American-Lincoln by Machine (con't)

GRACO#/Old Graco#	OEM	Description
Fits Condor (con't)		
8.805-718.0	56505836	DISC BRUSH-16" UNION MIX
8.805-719.0	56505838	DISC BRUSH-16" MIDLITE GRIT
Fits Condor 40" Cyl		
8.805-698.0	56413115	BRUSH 40" 180 GRIT
8.805-697.0	56413118	BRUSH 40" PROLENE
Fits Condor 45"		
8.805-694.0	56505830	PAD DRIVER ASSY-16" SHORT TRIM
8.805-695.0	56505834	DISC BRUSH-16" PROLENE
8.805-696.0	56505837	DISC BRUSH-16" MIDGRIT
Fits Condor 45" Cyl		
8.805-702.0	56413354	BRUSH 48" 180 GRIT
8.805-701.0	56413357	BRUSH 48" POLY
8.805-700.0	56413436	BRUSH 45" 180 GRIT
8.805-699.0	56413439	BRUSH 45" POLY
Fits Condor XL		
8.806-696.0	56110011	BRUSH, CYL 48" PROLENE
8.806-697.0	56110012	BRUSH, CYL 80 GRIT 48"
8.805-690.0	56110013	BRUSH 48" 180 MIDLITE
Fits Condor XL 40"		
8.805-691.0	56505790	PAD DRIVER ASSY-20" SHORT TRIM
8.805-692.0	56505794	DISC BRUSH-20" PROLENE
8.805-693.0	56505797	DISC BRUSH-20" MIDGRIT
Fits Convertamatic		
8.805-650.0	56505800	PAD DRIVER ASSY-14" SHORT TRIM
8.805-652.0	56505801	BRUSH-14" MAGNA GRIT 46
8.805-648.0	56505802	BRUSH-14" DYNA GRIT 80
8.805-654.0	56505803	BRUSH-14" AGLITE GRIT 500
8.805-651.0	56505805	BRUSH-14"PROLITE
8.805-646.0	56505806	BRUSH-14" UNION MIX
8.805-714.0	56505831	DISC BRUSH-16" MAGNAGRIT
8.805-715.0	56505832	DISC BRUSH-16" DYNAGRIT
8.805-716.0	56505833	DISC BRUSH-16" AGLITE
8.805-717.0	56505835	DISC BRUSH-16" PROLITE
8.805-718.0	56505836	DISC BRUSH-16" UNION MIX
8.805-719.0	56505838	DISC BRUSH-16" MIDLITE GRIT
Fits Convertamatic 28"		
8.805-653.0	565058080	BRUSH-14" MIDLITE GRIT 180
Fits Convertamatic 32"		
8.805-694.0	56505830	PAD DRIVER ASSY-16" SHORT TRIM
8.805-695.0	56505834	DISC BRUSH-16" PROLENE
8.805-696.0	56505837	DISC BRUSH-16" MIDGRIT



Advance American-Lincoln by Machine (con't)

GRACO#/Old Graco#	OEM	Description
Fits Convertamatic 38"		
8.805-691.0	56505790	PAD DRIVER ASSY-20" SHORT TRIM
8.805-692.0	56505794	DISC BRUSH-20" PROLENE
8.805-693.0	56505797	DISC BRUSH-20" MIDGRIT
Fits CR1000		
8.805-611.0	0765-271	BRUSH ASSY. BLACK NYLON
8.805-613.0	0765-273	BRUSH ASSY-SUPERGRIT
8.805-614.0	0765-274	BRUSH ASSY-CLEANGRIT
8.805-615.0	0780-497	PAD DRIVER ASSY. 20"
8.805-609.0	7-08-03313	BROOM,MAIN FIBRE/WIRE
8.805-608.0	8-08-03142	BROOM,MAIN NYLON,6 DOUBLE ROWS
Fits CR1000XL		
8.805-616.0	0765-256	BRUSH ASSY. BLACK NYLON 16"
8.805-618.0	0765-258	BRUSH ASSY. SUPER GRIT 16"
8.805-619.0	0765-265	BRUSH ASSY. CLEANGRIT 16"
8.805-620.0	0780-434	PAD DRIVER ASSY.16"
8.805-609.0	7-08-03313	BROOM,MAIN FIBRE/WIRE
8.805-608.0	8-08-03142	BROOM,MAIN NYLON,6 DOUBLE ROWS
Fits CR1100		
8.805-626.0	56505951	BROOM,MAIN POLY/WIRE,8 DOUBLE ROWS
8.805-623.0	56505953	BROOM,MAIN NYLON,8 DOUBLE ROWS
8.805-625.0	56505954	BROOM,MAIN PROEX,8 DOUBLE ROWS
8.805-622.0	56505956	BROOM,MAIN PROLENE,8 DOUBLE ROWS
Fits CR1200		
8.805-626.0	56505951	BROOM,MAIN POLY/WIRE,8 DOUBLE ROWS
8.805-623.0	56505953	BROOM,MAIN NYLON,8 DOUBLE ROWS
8.805-625.0	56505954	BROOM,MAIN PROEX,8 DOUBLE ROWS
8.805-622.0	56505956	BROOM,MAIN PROLENE,8 DOUBLE ROWS
Fits Exterra		
8.805-585.0	56507340	BROOM, MAIN PROEX-WIRE (CHEVRON)
8.805-588.0	56507341	BROOM, MAIN PROEX, 12 DOUBLE ROWS
8.805-586.0	56507342	BROOM,MAIN PROEX-WIRE,12 DOUBLE ROWS
8.805-591.0	56507343	BROOM, MAIN POLY,8 DOUBLE ROWS
8.805-590.0	56507344	BROOM, MAIN POLY/WIRE,12 DOUBLE ROWS
8.805-587.0	56507345	BROOM, MAIN NYLON,8 DOUBLE ROWS
8.805-589.0	56507346	BROOM, MAIN PROEX, 8 DOUBLE ROWS
8.805-592.0	56507350	BROOM, SIDE, POLY
8.805-593.0	56507351	BROOM, SIDE, NYLON 30DEG.
8.805-594.0	56507352	BROOM, SIDE, WIRE 30DEG.
8.805-584.0	56507424	BROOM, MAIN PROEX-WIRE
8.805-595.0	56508498	BROOM, SIDE, POLY 41 DEG.
8.805-596.0	56508499	BROOM, SIDE, NYLON 41 DEG.



Advance American-Lincoln by Machine (con't)

GRACO#/Old Graco#	OEM	Description
Fits Granterra		
8.805-597.0	8-08-03202	BROOM,MAIN PROEX-WIRE,8 DOUBLE ROWS
8.805-599.0	8-08-03204	BROOM,MAIN PROEX,8 DOUBLE ROWS
8.805-602.0	8-08-03209	BROOM,MAIN POLY,8 DOUBLE ROWS
8.805-603.0	8-08-03211	BROOM,SIDE NYLON
8.805-604.0	8-08-03212	BROOM,SIDE POLY
8.805-601.0	8-08-03214	BROOM,POLY/WIRE,8 DOUBLE ROWS
Fits Hydroretriever 3800		
8.805-691.0	56505790	PAD DRIVER ASSY-20" SHORT TRIM
8.805-692.0	56505794	DISC BRUSH-20" PROLENE
8.805-693.0	56505797	DISC BRUSH-20" MIDGRIT
Fits IMAX 328C		
8.806-695.0	56412194	BRUSH, DYNA GRIT 80, 28"
Fits IMAX 32C		
8.806-699.0	56407477	BRUSH, DYNA GRIT 80, 32"
Fits LYNX 385		
8.805-691.0	56505790	PAD DRIVER ASSY-20" SHORT TRIM
8.805-692.0	56505794	DISC BRUSH-20" PROLENE
8.805-693.0	56505797	DISC BRUSH-20" MIDGRIT
Fits ProTerra		
8.805-555.0	33017255	BROOM, SIDE POLY
8.805-559.0	33018856	BROOM, MAIN NYLON SPIRAL
8.805-560.0	33018857	BROOM, MAIN POLY WHITE/NAVY
8.805-558.0	33018858	BROOM, MAIN POLY/STEEL
8.805-561.0	33018859	BROOM, MAIN UNION MIX SPIRAL
8.805-556.0	33018889	BROOM, SIDE POLY/STEEL
8.805-557.0	33018890	BROOM, SIDE NYLON
Fits Razor Plus 28"		
8.806-694.0	56412193	BRUSH 180 GRIT 28"
8.806-695.0	56412194	BRUSH, DYNA GRIT 80, 28"
Fits SC750 28"		
8.806-694.0	56412193	BRUSH 180 GRIT 28"
8.806-695.0	56412194	BRUSH, DYNA GRIT 80, 28"
8.806-698.0	56407476	BRUSH, MIDLITE GRIT 180, 32"
8.806-694.0	56412193	BRUSH 180 GRIT 28"
8.806-695.0	56412194	BRUSH, DYNA GRIT 80, 28"
8.806-698.0	56407476	BRUSH, MIDLITE GRIT 180, 32"
8.806-698.0	56407476	BRUSH, MIDLITE GRIT 180, 32"
Fits SR1900		
8.805-588.0	56507341	BROOM, MAIN PROEX, 12 DOUBLE ROWS
8.805-586.0	56507342	BROOM,MAIN PROEX-WIRE,12 DOUBLE ROWS
8.805-591.0	56507343	BROOM, MAIN POLY,8 DOUBLE ROWS



Advance American-Lincoln by Machine (con't)

GRACO#/Old Graco#	OEM	Description
Fits SR1900 (con't)		
8.805-590.0	56507344	BROOM, MAIN POLY/WIRE,12 DOUBLE ROWS
8.805-587.0	56507345	BROOM, MAIN NYLON,8 DOUBLE ROWS
8.805-589.0	56507346	BROOM, MAIN PROEX, 8 DOUBLE ROWS
8.805-593.0	56507351	BROOM, SIDE, NYLON 30DEG.
8.805-594.0	56507352	BROOM, SIDE, WIRE 30DEG.
8.805-595.0	56508498	BROOM, SIDE, POLY 41 DEG.
8.805-596.0	56508499	BROOM, SIDE, NYLON 41 DEG.
Fits SR2000		
8.805-599.0	8-08-03204	BROOM,MAIN PROEX,8 DOUBLE ROWS
8.805-602.0	8-08-03209	BROOM,MAIN POLY,8 DOUBLE ROWS
Fits Terra 3700B		
8.805-570.0	1451899000	BROOM, SIDE POLY
8.805-571.0	1454959000	BROOM, SIDE STEEL MIX
8.805-572.0	1454976000	BROOM, SIDE NATURAL FIBER
8.805-569.0	1460678000	BROOM, SIDE NYLON STD.
8.805-566.0	1460748000	BROOM, MAIN POLY
8.805-568.0	1460749000	BROOM, MAIN NATURAL FIBER
8.805-567.0	1460750000	BROOM, MAIN STEEL MIX
8.805-564.0	1460751000	BROOM, MAIN POLY
8.805-562.0	1460752000	BROOM, MAIN NYLON STD.
8.805-563.0	1460753000	BROOM, MAIN NATURAL FIBER
8.805-565.0	1460754000	BROOM, MAIN STEEL MIX
Fits Terra 4300B		
8.805-573.0	1454879000	BROOM, MAIN STD
8.805-575.0	1456080000	BROOM, MAIN NATURAL FIBRE
Fits Terra 5200B		
8.805-580.0	1454963000	BROOM, MAIN
8.805-579.0	1456135000	BROOM, MAIN
8.805-578.0	1461018000	BROOM, MAIN POLY
8.805-581.0	1461025000	BROOM, SIDE
8.805-582.0	1461148000	BROOM, SIDE
8.805-583.0	1461149000	BROOM, SIDE
Fits Warrior ST 32D		
8.805-694.0	56505830	PAD DRIVER ASSY-16" SHORT TRIM
8.805-695.0	56505834	DISC BRUSH-16" PROLENE
8.805-696.0	56505837	DISC BRUSH-16" MIDGRIT



Tennant - Nobles (con't)

GRACO#/Old Graco#	OEM	Description	Fits
88054720	54922	BRUSH,SWEEP 45"-24SR,NYLON	355, 385, 6500, 6550, 6600, 6650, 8400, 8410, S30
88054730	54923	BRUSH,SWEEP 45"-8DR,NYLON	355, 385, 6500, 6550, 6600, 6650, 8400, 8410, S30
88054740	54925	BRUSH,SWP 45"8DR, POLY/WIRE, SPIRAL	355, 385, 6500, 6550, 6600, 6650, 8400, 8410, S30
88054750	54927	BRUSH,SWEEP 45"24SR FIBER/WIRE	355, 385, 6500, 6550, 6600, 6650, 8400, 8410, S30
88055150	05724	BRUSH ASSY, DISK, 16" NYLON	515, 515SS, 5680 32", 5700 32", 7080 32", 7100 32", 7400, 8010, 8200, 8210, 8400, 8410, EZ RIDER HP 32"
88055160	05725	BRUSH ASSY, DISK, SCB, 16.0D, PYP STF	515, 515SS, 5680 32", 5700 32", 7080 32", 7100 32", 7400, 8010, 8200, 8210, 8400, 8410, EZ RIDER HP 32"
88055170	05726	BRUSH ASSY, DISK, 16" GRIT	515, 515SS, 5680 32", 5700 32", 7080 32", 7100 32", 7400, 8010, 8200, 8210, 8400, 8410, EZ RIDER HP 32"
88054630	11771	BRUSH ASSY, DISK,18" POLY	5680-36", 5700-36", T15, T16
88054640	11772	BRUSH ASSY, DISK,18" GRIT	5680-36", 5700-36", T15, T16
88054650	11773	BRUSH ASSY, DISK,18" NYLON	5680-36", 5700-36", T15, T16
88057840	14953	BRUSH ASSY, DISK 20"POLY	515, 7300, 8300, 8200, 8210, M30
88057850	14967	BRUSH ASSY, DISK 20" NYLON	515, 7300, 8300, 8200, 8210, M30
88054760	59431	BRUSH, SIDE SWEEP,23"DIA,POLY	355, 385, 6400, 6500, 6550, 6600, 6650, 8200, 8210, 8400, 8410, S20
88054770	59432	BRUSH, SIDE SWEEP,23"DIA, FLATWIRE	355, 385, 6400, 6500, 6550, 6600, 6650, 8200, 8210
88054780	59440	BRUSH,SWEEP, 45"8DR WIRE, SPIRAL	355, 385, 6500, 6550, 6600, 6650, 8400, 8410, S30
88054790	66019	BRUSH,SWEEP 45"-8DR,POLY SPIRAL	355, 385, 6500, 6550, 6600, 6650, 8400, 8410, S30
88054800	70538	BRUSH, SIDE SWEEP, 26"POLY	6500, 6550, 6600, 6650, 800, 810
88054810	71170	BRUSH,SCRUB,45" 24SR,POLY,SPIRAL	7400
88054820	71171	BRUSH, SCRUB,45" 24SR,NYLON,SPIRAL	7400
88054830	71612	BRUSH, SCRUB,45" 24SR,GRIT,SPIRAL	7400
88054840	80042	BRUSH, SIDE SWEEP,16.5" POLY	3640, 6080, 6100
88054850	81888	BRUSH, SWEEP,22" POLY SPIRAL	6100
88054860	83030	BRUSH, SWEEP,22" WEDGE, POLY SPIRAL	6100
88054870	83031	BRUSH, SWEEP,22" 8SR,UNION MIX SPIRAL	6100
88054880	87097	BRUSH,SWEEP,36" POLY/WIRE	6400, 8200, 8210, S20, T20
88054890	87099	BRUSH,SWEEP,36" POLY	6400, 8200, 8210, S20
88057870	87419	BRUSH, DISK, SWEEP, 19",POLY	T16, 515, 7300, 8010, 8300
88054900	222304	BRUSH, SCRUB, 28"18SR, POLY SPIRAL	5680 28", 5700 28", 7080 28", 7100 28", 7200 28", EZ Rider HP 28", Speed Scrub Rider 26", T7 26", EZ RIDER 28"
88054910	222305	BRUSH, SCRUB, 28"18SR, NYLON SPIRAL	5680 28", 5700 28", 7080 28", 7100 28", 7200 28", EZ Rider HP 28", Speed Scrub Rider 26", T7 26", EZ RIDER 28"
88054920	222306	BRUSH, SCRUB, 28"18SR, GRIT SPIRAL	5680 28", 5700 28", 7080 28", 7100 28", 7200 28", EZ Rider HP 28", Speed Scrub Rider 26", T7 26", EZ RIDER 28"
88054930	222307	BRUSH, SCRUB,32"18SR,STIFF POLY SPIRAL	5680 32", 5700 32", 7080 32", 7100 32", A5, EZ Rider HP 32", Speed Scrub Rider 32", T5, T7 32", EZ RIDER 32", SPEED SCRUB 32"
88054940	222308	BRUSH, SCRUB,32"18SR,NYLON SPIRAL	5680 32", 5700 32", 7080 32", 7100 32", A5, EZ Rider HP 32", Speed Scrub Rider 32", T5, T7 32", EZ RIDER 32", SPEED SCRUB 32"
88054950	222309	BRUSH, SCRUB,32"18SR,GRIT SPIRAL	5680 32", 5700 32", 7080 32", 7100 32", A5, EZ Rider HP 32", Speed Scrub Rider 32", T5, T7 32", EZ RIDER 32", SPEED SCRUB 32"



Tennant - Nobles (con't)

GRACO#/Old Graco#	OEM	Description	Fits
88054960	222310	BRUSH, SCRUB,36"18SR, STIFF POLY SPIR	5680 36", 5700 36", 7200 36", T15 36"
88054970	222311	BRUSH, SCRUB,36"18SR,STIFF NYL SPIRAL	5680 36", 5700 36", 7200 36", T15 36"
88054980	222312	BRUSH, SCB, 36L, 18SR, ABR, SPL	5680 36", 5700 36", 7200 36", T15 36"
88054990	222320	BRUSH ASSY, DISK,14" POLY	5680 28", 5700 28", 7080 28", 7100 28", 7200 28", EZ Rider HP 28", T20, EZ RIDER 28"
88055000	222321	BRUSH ASSY, DISK,14" NYLON	5680 28", 5700 28", 7080 28", 7100 28", 7200 28", EZ Rider HP 28", T20, EZ RIDER 28"
88055010	222322	BRUSH ASSY, DISK,14".060 GRIT	5680 28", 5700 28", 7080 28", 7100 28", 7200 28", EZ Rider HP 28", T20, EZ RIDER 28"
88054710	51542	Brush,Side Swp 26" Dia.Flatwire	6500, 6550, 6600, 6650, 800, 810,
88054660	30241	BRUSH ASSY, DISK,16"POLY	515, 515SS, 5680-32", 5700 32", 7080 32", 7100 32", 7400, 8010, 8210, 8400,8410, EZ RIDER HP
88054670	35323	BRUSH, SWP,50"24SR, NYLON SPIRAL	800, 810
88054680	35324	BRUSH, SWP,50" DR, POLY/WIRE SPIROL	800, 810
88054690	35325	BRUSH, SWP, 50L, 8DR, POLY SPIROL	800, 810
88057860	35326	BRUSH,SWEEP,50",8DR, POLYP SPIRAL	800, 810
88054700	35327	BRUSH, SWP, 50L, 8DR, WIRE SPIRAL	800, 810
88055020	370008	BRUSH, SWEEP,45", WEDGE, POLY SPIRAL	355, 385, 6500, 6550, 6600, 6650, 8400, 8410, S30
88055030	374042	BRUSH, SCRUB,32"18SR, MED.POLY SPIRAL	5680 32", 5700 32", 7080 32", 7100 32", A5, EZ Rider HP 32", Speed Scrub Rider 32", T5, T7 32", EZ RIDER 32", SPEED SCRUB 32"
88055040	374043	BRUSH, SCRUB,36"18SR, SOFT POLY SPIRAL	5680 36", 5700 36", 7200 36", T15 36"
88055050	383487	BRUSH,SWEEP, 28" 8SR POLY SPIRAL	6200
88055060	383993	BRUSH,SWEEP, 28" 8SR UNION MIX	6200
88055080	397914	PAD DRIVER ASSY. 14"	5680 28", 5700 28", 7080 28", 7100 28", 7200 28", EZ Rider HP 28", T20, EZ RIDER 28"
88055320	397916	PAD DRIVER ASSY. 16"	5680-32", 5700-32", 7080, 7100, 7300, 8300, EZ Rider HP 32"
88055330	397918	PAD DRIVER ASSY. 18"	5680-36", 5700-36", T15, T16
88055090	1026222	BRUSH,SWEEP/SCRUB, 40" SUPER ABRASIVE	M20, T20
88055100	1026223	BRUSH,SWEEP/SCRUB, 40" POLY	M20, T20
88057370	1027688	BRUSH, SIDE POLY 24"	M20, M30, T20
88055110	1033246	BRUSH,SWEEP/SCRUB, 48" 24SR POLYESTER	M30
88055120	1033372	BRUSH,SWEEP/SCRUB, 48"SUPER ABRASIVE	M30
88055130	1033374	BRUSH,SWEEP/SCRUB, 48" 24SR HD POLY	M30
88055140	1033375	BRUSH,SWEEP/SCRUB, 48" 24SR POLY	M30
88057390	1042499	BRUSH ASSY, DISC 16" NYLON	515, 515SS, 5680 32", 5700 32", 7080 32", 7100 32", 7400, 8010, 8200, 8210, 8400, 8410, EZ RIDER HP 32"
88055160	1042500	BRUSH ASSY, DISK, SCB, 16.0D, PYP STF	515, 515SS, 5680 32", 5700 32", 7080 32", 7100 32", 7400, 8010, 8200, 8210, 8400, 8410, EZ RIDER HP 32"
88057380	1042504	BRUSH ASSY, DISC, 16" GRIT	515, 515SS, 5680 32", 5700 32", 7080 32", 7100 32", 7400, 8010, 8200, 8210, 8400, 8410, EZ RIDER HP 32"
88055180	08013N	BRUSH,SIDE SWEEP, 23"NYLON	355, 385, 6400, 6550, 6650, 8200, 8210, 8400, 8410, S20
88057880	28007P	BRUSH, SWEEP, 26" 6DR, POLY	S10
88055190	51021N	BRUSH,SIDE SWEEP, 26"NYLON	6500, 6550, 6600, 6650, 800, 810



Tennant - Nobles by Machine (con't)

GRACO#/Old Graco#	OEM	Description
Fits 355		
8.805-472.0	54922	BRUSH,SWEEP 45"-24SR,NYLON
8.805-473.0	54923	BRUSH,SWEEP 45"-8DR,NYLON
8.805-474.0	54925	BRUSH,SWP 45"8DR, POLY/WIRE, SPIRAL
8.805-475.0	54927	BRUSH,SWEEP 45"24SR FIBER/WIRE
8.805-477.0	59432	BRUSH, SIDE SWEEP,23"DIA, FLATWIRE
8.805-478.0	59440	BRUSH,SWEEP, 45"8DR WIRE, SPIRAL
8.805-479.0	66019	BRUSH,SWEEP 45"-8DR,POLY SPIRAL
8.805-502.0	370008	BRUSH, SWEEP,45", WEDGE, POLY SPIRAL
8.805-516.0	05725, 1042500	BRUSH ASSY, DISK,16"STIFF POLY
8.805-518.0	08013N	BRUSH,SIDE SWEEP, 23"NYLON
Fits 385		
8.805-472.0	54922	BRUSH,SWEEP 45"-24SR,NYLON
8.805-473.0	54923	BRUSH,SWEEP 45"-8DR,NYLON
8.805-474.0	54925	BRUSH,SWP 45"8DR, POLY/WIRE, SPIRAL
8.805-475.0	54927	BRUSH,SWEEP 45"24SR FIBER/WIRE
Fits 385 (con't)		
8.805-478.0	59440	BRUSH,SWEEP, 45"8DR WIRE, SPIRAL
8.805-479.0	66019	BRUSH,SWEEP 45"-8DR,POLY SPIRAL
8.805-502.0	370008	BRUSH, SWEEP,45", WEDGE, POLY SPIRAL
8.805-516.0	05725, 1042500	BRUSH ASSY, DISK,16"STIFF POLY
8.805-518.0	08013N	BRUSH,SIDE SWEEP, 23"NYLON
Fits 515		
8.805-515.0	05724	BRUSH ASSY, DISK, 16" NYLON
8.805-517.0	05726	BRUSH ASSY, DISK, 16" GRIT
8.805-784.0	14953	BRUSH ASSY, DISK 20"POLY
8.805-785.0	14967	BRUSH ASSY, DISK 20" NYLON
8.805-466.0	30241	BRUSH ASSY, DISK,16"POLY
8.805-787.0	87419	BRUSH, DISK, SWEEP, 19",POLY
Fits 800		
8.805-467.0	35323	BRUSH, SWP,50"24SR, NYLON SPIRAL
8.805-468.0	35324	BRUSH, SWP,50" DR, POLY/WIRE SPIRAL
8.805-469.0	35325	BRUSH, SWP, 50L, 8DR, POLY SPIRAL
8.805-786.0	35326	BRUSH,SWEEP,50",8DR, POLYP SPIRAL
8.805-470.0	35327	BRUSH, SWP, 50L, 8DR, WIRE SPIRAL
8.805-471.0	51542	Brush,Side Swp 26" Dia.Flatwire
8.805-480.0	70538	BRUSH, SIDE SWEEP, 26"POLY
8.805-519.0	51021N	BRUSH,SIDE SWEEP, 26"NYLON
Fits 810		
8.805-467.0	35323	BRUSH, SWP,50"24SR, NYLON SPIRAL
8.805-468.0	35324	BRUSH, SWP,50" DR, POLY/WIRE SPIRAL
8.805-469.0	35325	BRUSH, SWP, 50L, 8DR, POLY SPIRAL
8.805-786.0	35326	BRUSH,SWEEP,50",8DR, POLYP SPIRAL
8.805-470.0	35327	BRUSH, SWP, 50L, 8DR, WIRE SPIRAL
8.805-471.0	51542	Brush,Side Swp 26" Dia.Flatwire
8.805-480.0	70538	BRUSH, SIDE SWEEP, 26"POLY



Tennant - Nobles by Machine (con't)

GRACO#/Old Graco#	OEM	Description
Fits 810 (con't)		
8.805-519.0	51021N	BRUSH,SIDE SWEEP, 26"NYLON
8.805-484.0	80042	BRUSH, SIDE SWEEP,16.5" POLY
Fits 6080		
8.805-484.0	80042	BRUSH, SIDE SWEEP,16.5" POLY
Fits 6100		
8.805-484.0	80042	BRUSH, SIDE SWEEP,16.5" POLY
8.805-485.0	81888	BRUSH, SWEEP,22" POLY SPIRAL
8.805-486.0	83030	BRUSH, SWEEP,22" WEDGE, POLY SPIRAL
8.805-487.0	83031	BRUSH, SWEEP,22" 8SR,UNION MIX SPIRAL
Fits 6200		
8.805-505.0	383487	BRUSH,SWEEP, POLY SPIRAL
8.805-506.0	383993	BRUSH,SWEEP, NATURAL FIBER
Fits 6400		
8.805-471.0	51542	Brush,Side Swp 26" Dia.Flatwire
8.805-472.0	54922	BRUSH,SWEEP 45"-24SR,NYLON
8.805-473.0	54923	BRUSH,SWEEP 45"-8DR,NYLON
8.805-474.0	54925	BRUSH,SWP 45"8DR, POLY/WIRE, SPIRAL
8.805-476.0	59431	BRUSH, SIDE SWEEP,23"DIA,POLY
8.805-477.0	59432	BRUSH, SIDE SWEEP,23"DIA, FLATWIRE
8.805-488.0	87097	BRUSH,SWEEP,36" POLY/WIRE
8.805-489.0	87099	BRUSH,SWEEP,36" POLY
8.805-502.0	370008	BRUSH, SWEEP,45", WEDGE, POLY SPIRAL
8.805-516.0	05725, 1042500	BRUSH ASSY, DISK,16"STIFF POLY
8.805-518.0	08013N	BRUSH,SIDE SWEEP, 23"NYLON
Fits 6500		
8.805-471.0	51542	Brush,Side Swp 26" Dia.Flatwire
8.805-472.0	54922	BRUSH,SWEEP 45"-24SR,NYLON
8.805-473.0	54923	BRUSH,SWEEP 45"-8DR,NYLON
8.805-474.0	54925	BRUSH,SWP 45"8DR, POLY/WIRE, SPIRAL
8.805-475.0	54927	BRUSH,SWEEP 45"24SR FIBER/WIRE
8.805-478.0	59440	BRUSH,SWEEP, 45"8DR WIRE, SPIRAL
8.805-479.0	66019	BRUSH,SWEEP 45"-8DR,POLY SPIRAL
8.805-480.0	70538	BRUSH, SIDE SWEEP, 26"POLY
8.805-502.0	370008	BRUSH, SWEEP,45", WEDGE, POLY SPIRAL
8.805-516.0	05725, 1042500	BRUSH ASSY, DISK,16"STIFF POLY
8.805-519.0	51021N	BRUSH,SIDE SWEEP, 26"NYLON
Fits 6550		
8.805-471.0	51542	Brush,Side Swp 26" Dia.Flatwire
8.805-472.0	54922	BRUSH,SWEEP 45"-24SR,NYLON
8.805-473.0	54923	BRUSH,SWEEP 45"-8DR,NYLON
8.805-474.0	54925	BRUSH,SWP 45"8DR, POLY/WIRE, SPIRAL
8.805-475.0	54927	BRUSH,SWEEP 45"24SR FIBER/WIRE
8.805-476.0	59431	BRUSH, SIDE SWEEP,23"DIA,POLY
Fits 6550 (con't)		



Tennant - Nobles by Machine (con't)

GRACO#/Old Graco#	OEM	Description
Fits 6550 (con't)		
8.805-477.0	59432	BRUSH, SIDE SWEEP, 23"DIA, FLATWIRE
8.805-478.0	59440	BRUSH, SWEEP, 45"8DR WIRE, SPIRAL
8.805-479.0	66019	BRUSH, SWEEP 45"-8DR, POLY SPIRAL
8.805-480.0	70538	BRUSH, SIDE SWEEP, 26"POLY
8.805-502.0	370008	BRUSH, SWEEP, 45", WEDGE, POLY SPIRAL
8.805-516.0	05725, 1042500	BRUSH ASSY, DISK, 16"STIFF POLY
8.805-518.0	08013N	BRUSH, SIDE SWEEP, 23"NYLON
8.805-519.0	51021N	BRUSH, SIDE SWEEP, 26"NYLON
Fits 6600		
8.805-471.0	51542	Brush, Side Swp 26" Dia. Flatwire
8.805-472.0	54922	BRUSH, SWEEP 45"-24SR, NYLON
8.805-473.0	54923	BRUSH, SWEEP 45"-8DR, NYLON
8.805-474.0	54925	BRUSH, SWP 45"8DR, POLY/WIRE, SPIRAL
8.805-475.0	54927	BRUSH, SWEEP 45"24SR FIBER/WIRE
8.805-478.0	59440	BRUSH, SWEEP, 45"8DR WIRE, SPIRAL
8.805-479.0	66019	BRUSH, SWEEP 45"-8DR, POLY SPIRAL
8.805-480.0	70538	BRUSH, SIDE SWEEP, 26"POLY
8.805-502.0	370008	BRUSH, SWEEP, 45", WEDGE, POLY SPIRAL
8.805-519.0	51021N	BRUSH, SIDE SWEEP, 26"NYLON
Fits 6650		
8.805-471.0	51542	Brush, Side Swp 26" Dia. Flatwire
8.805-472.0	54922	BRUSH, SWEEP 45"-24SR, NYLON
8.805-473.0	54923	BRUSH, SWEEP 45"-8DR, NYLON
8.805-474.0	54925	BRUSH, SWP 45"8DR, POLY/WIRE, SPIRAL
8.805-475.0	54927	BRUSH, SWEEP 45"24SR FIBER/WIRE
8.805-476.0	59431	BRUSH, SIDE SWEEP, 23"DIA, POLY
8.805-477.0	59432	BRUSH, SIDE SWEEP, 23"DIA, FLATWIRE
8.805-478.0	59440	BRUSH, SWEEP, 45"8DR WIRE, SPIRAL
8.805-479.0	66019	BRUSH, SWEEP 45"-8DR, POLY SPIRAL
8.805-480.0	70538	BRUSH, SIDE SWEEP, 26"POLY
8.805-502.0	370008	BRUSH, SWEEP, 45", WEDGE, POLY SPIRAL
8.805-518.0	08013N	BRUSH, SIDE SWEEP, 23"NYLON
8.805-519.0	51021N	BRUSH, SIDE SWEEP, 26"NYLON
Fits 7300		
8.805-784.0	14953	BRUSH ASSY, DISK 20"POLY
8.805-785.0	14967	BRUSH ASSY, DISK 20" NYLON
8.805-787.0	87419	BRUSH, DISK, SWEEP, 19", POLY
8.805-739.0	1042499	BRUSH ASSY, DISC 16" NYLON
8.805-738.0	1042504	BRUSH ASSY, DISC, 16" GRIT
Fits 7400		
8.805-515.0	05724	BRUSH ASSY, DISK, 16" NYLON
8.805-517.0	05726	BRUSH ASSY, DISK, 16" GRIT
8.805-466.0	30241	BRUSH ASSY, DISK, 16"POLY
8.805-481.0	71170	BRUSH, SCRUB, 45" 24SR, POLY, SPIRAL
8.805-482.0	71171	BRUSH, SCRUB, 45" 24SR, NYLON, SPIRAL



Tennant - Nobles by Machine (con't)

GRACO#/Old Graco#	OEM	Description
Fits 7400 (con't)		
8.805-483.0	71612	BRUSH, SCRUB,45" 24SR,GRIT,SPIRAL
8.805-516.0	05725, 1042500	BRUSH ASSY, DISK,16"STIFF POLY
Fits 8010		
8.805-787.0	87419	BRUSH, DISK, SWEEP, 19",POLY
Fits 8200		
8.805-515.0	05724	BRUSH ASSY, DISK, 16" NYLON
8.805-517.0	05726	BRUSH ASSY, DISK, 16" GRIT
8.805-784.0	14953	BRUSH ASSY, DISK 20"POLY
8.805-785.0	14967	BRUSH ASSY, DISK 20" NYLON
8.805-466.0	30241	BRUSH ASSY, DISK,16"POLY
8.805-476.0	59431	BRUSH, SIDE SWEEP,23"DIA,POLY
8.805-477.0	59432	BRUSH, SIDE SWEEP,23"DIA, FLATWIRE
8.805-488.0	87097	BRUSH,SWEEP,36" POLY/WIRE
8.805-489.0	87099	BRUSH,SWEEP,36" POLY
8.805-516.0	05725, 1042500	BRUSH ASSY, DISK,16"STIFF POLY
8.805-518.0	08013N	BRUSH,SIDE SWEEP, 23"NYLON
Fits 8210		
8.805-515.0	05724	BRUSH ASSY, DISK, 16" NYLON
8.805-517.0	05726	BRUSH ASSY, DISK, 16" GRIT
8.805-784.0	14953	BRUSH ASSY, DISK 20"POLY
8.805-785.0	14967	BRUSH ASSY, DISK 20" NYLON
8.805-466.0	30241	BRUSH ASSY, DISK,16"POLY
8.805-476.0	59431	BRUSH, SIDE SWEEP,23"DIA,POLY
8.805-477.0	59432	BRUSH, SIDE SWEEP,23"DIA, FLATWIRE
8.805-488.0	87097	BRUSH,SWEEP,36" POLY/WIRE
8.805-489.0	87099	BRUSH,SWEEP,36" POLY
8.805-516.0	05725, 1042500	BRUSH ASSY, DISK,16"STIFF POLY
8.805-518.0	08013N	BRUSH,SIDE SWEEP, 23"NYLON
Fits 8300		
8.805-784.0	14953	BRUSH ASSY, DISK 20"POLY
8.805-785.0	14967	BRUSH ASSY, DISK 20" NYLON
8.805-787.0	87419	BRUSH, DISK, SWEEP, 19",POLY
8.805-739.0	1042499	BRUSH ASSY, DISC 16" NYLON
8.805-738.0	1042504	BRUSH ASSY, DISC, 16" GRIT
Fits 8400		
8.805-515.0	05724	BRUSH ASSY, DISK, 16" NYLON
8.805-517.0	05726	BRUSH ASSY, DISK, 16" GRIT
8.805-466.0	30241	BRUSH ASSY, DISK,16"POLY
8.805-472.0	54922	BRUSH,SWEEP 45"-24SR,NYLON
8.805-473.0	54923	BRUSH,SWEEP 45"-8DR,NYLON
8.805-474.0	54925	BRUSH,SWP 45"8DR, POLY/WIRE, SPIRAL
8.805-475.0	54927	BRUSH,SWEEP 45"24SR FIBER/WIRE
8.805-476.0	59431	BRUSH, SIDE SWEEP,23"DIA,POLY
8.805-477.0	59432	BRUSH, SIDE SWEEP,23"DIA, FLATWIRE



Tennant - Nobles by Machine (con't)

GRACO#/Old Graco#	OEM	Description
Fits 8400 (con't)		
8.805-478.0	59440	BRUSH,SWEEP, 45"8DR WIRE, SPIRAL
8.805-479.0	66019	BRUSH,SWEEP 45"-8DR,POLY SPIRAL
8.805-502.0	370008	BRUSH, SWEEP,45", WEDGE, POLY SPIRAL
8.805-516.0	05725, 1042500	BRUSH ASSY, DISK,16"STIFF POLY
8.805-518.0	08013N	BRUSH,SIDE SWEEP, 23"NYLON
Fits 8410		
8.805-515.0	05724	BRUSH ASSY, DISK, 16" NYLON
8.805-517.0	05726	BRUSH ASSY, DISK, 16" GRIT
8.805-466.0	30241	BRUSH ASSY, DISK,16"POLY
8.805-472.0	54922	BRUSH,SWEEP 45"-24SR,NYLON
8.805-473.0	54923	BRUSH,SWEEP 45"-8DR,NYLON
8.805-474.0	54925	BRUSH,SWP 45"8DR, POLY/WIRE, SPIRAL
8.805-475.0	54927	BRUSH,SWEEP 45"24SR FIBER/WIRE
8.805-477.0	59432	BRUSH, SIDE SWEEP,23"DIA, FLATWIRE
8.805-478.0	59440	BRUSH,SWEEP, 45"8DR WIRE, SPIRAL
8.805-479.0	66019	BRUSH,SWEEP 45"-8DR,POLY SPIRAL
8.805-502.0	370008	BRUSH, SWEEP,45", WEDGE, POLY SPIRAL
8.805-516.0	05725, 1042500	BRUSH ASSY, DISK,16"STIFF POLY
8.805-518.0	08013N	BRUSH,SIDE SWEEP, 23"NYLON
Fits 5680 28"		
8.805-490.0	222304	BRUSH, SCRUB, 28"18SR, POLY SPIRAL
8.805-491.0	222305	BRUSH, SCRUB, 28"18SR, NYLON SPIRAL
8.805-492.0	222306	BRUSH, SCRUB, 28"18SR, GRIT SPIRAL
8.805-499.0	222320	BRUSH ASSY, DISK,14" POLY
8.805-500.0	222321	BRUSH ASSY, DISK,14" NYLON
8.805-501.0	222322	BRUSH ASSY, DISK,14".060 GRIT
8.805-508.0	397914, 222323	PAD DRIVER ASSY. 14"
Fits 5680 32"		
8.805-517.0	05726	BRUSH ASSY, DISK, 16" GRIT
8.805-466.0	30241	BRUSH ASSY, DISK,16"POLY
8.805-493.0	222307	BRUSH, SCRUB,32"18SR,STIFF POLY SPIRAL
8.805-494.0	222308	BRUSH, SCRUB,32"18SR,NYLON SPIRAL
8.805-495.0	222309	BRUSH, SCRUB,32"18SR,GRIT SPIRAL
8.805-503.0	374042	BRUSH, SCRUB,32"18SR, MED.POLY SPIRAL
8.805-532.0	397916	PAD DRIVER ASSY. 16"
Fits 5680 36"		
8.805-515.0	05724	BRUSH ASSY, DISK, 16" NYLON
8.805-463.0	11771	BRUSH ASSY, DISK,18" POLY
8.805-464.0	11772	BRUSH ASSY, DISK,18" GRIT
8.805-465.0	11773	BRUSH ASSY, DISK,18" NYLON
8.805-496.0	222310	BRUSH, SCRUB,36"18SR, POLY SPIRAL
8.805-497.0	222311	BRUSH, SCRUB,36"18SR,NYLON SPIRAL
8.805-498.0	222312	BRUSH, SCRUB,36"18SR,GRIT SPIRAL
8.805-504.0	374043	BRUSH, SCRUB,36"18SR, POLY SPIRAL
8.805-533.0	397918	PAD DRIVER ASSY. 18"



Tennant - Nobles by Machine (con't)

GRACO#/Old Graco#	OEM	Description
Fits 5700 28"		
8.805-490.0	222304	BRUSH, SCRUB, 28"18SR, POLY SPIRAL
8.805-491.0	222305	BRUSH, SCRUB, 28"18SR, NYLON SPIRAL
8.805-492.0	222306	BRUSH, SCRUB, 28"18SR, GRIT SPIRAL
8.805-499.0	222320	BRUSH ASSY, DISK,14" POLY
8.805-500.0	222321	BRUSH ASSY, DISK,14" NYLON
8.805-501.0	222322	BRUSH ASSY, DISK,14".060 GRIT
8.805-508.0	397914, 222323	PAD DRIVER ASSY. 14"
Fits 5700 32"		
8.805-515.0	05724	BRUSH ASSY, DISK, 16" NYLON
8.805-517.0	05726	BRUSH ASSY, DISK, 16" GRIT
8.805-466.0	30241	BRUSH ASSY, DISK,16"POLY
8.805-493.0	222307	BRUSH, SCRUB,32"18SR,STIFF POLY SPIRAL
8.805-494.0	222308	BRUSH, SCRUB,32"18SR,NYLON SPIRAL
8.805-495.0	222309	BRUSH, SCRUB,32"18SR,GRIT SPIRAL
8.805-503.0	374042	BRUSH, SCRUB,32"18SR, MED.POLY SPIRAL
8.805-532.0	397916	PAD DRIVER ASSY. 16"
8.805-739.0	1042499	BRUSH ASSY, DISC 16" NYLON
8.805-738.0	1042504	BRUSH ASSY, DISC, 16" GRIT
Fits 5700 36"		
8.805-463.0	11771	BRUSH ASSY, DISK,18" POLY
8.805-464.0	11772	BRUSH ASSY, DISK,18" GRIT
8.805-465.0	11773	BRUSH ASSY, DISK,18" NYLON
8.805-496.0	222310	BRUSH, SCRUB,36"18SR, POLY SPIRAL
8.805-497.0	222311	BRUSH, SCRUB,36"18SR,NYLON SPIRAL
8.805-498.0	222312	BRUSH, SCRUB,36"18SR,GRIT SPIRAL
8.805-504.0	374043	BRUSH, SCRUB,36"18SR, POLY SPIRAL
8.805-533.0	397918	PAD DRIVER ASSY. 18"
Fits 7080 28"		
8.805-490.0	222304	BRUSH, SCRUB, 28"18SR, POLY SPIRAL
8.805-491.0	222305	BRUSH, SCRUB, 28"18SR, NYLON SPIRAL
8.805-492.0	222306	BRUSH, SCRUB, 28"18SR, GRIT SPIRAL
8.805-499.0	222320	BRUSH ASSY, DISK,14" POLY
8.805-500.0	222321	BRUSH ASSY, DISK,14" NYLON
8.805-501.0	222322	BRUSH ASSY, DISK,14".060 GRIT
8.805-508.0	397914, 222323	PAD DRIVER ASSY. 14"
Fits 7080 32"		
8.805-515.0	05724	BRUSH ASSY, DISK, 16" NYLON
8.805-517.0	05726	BRUSH ASSY, DISK, 16" GRIT
8.805-466.0	30241	BRUSH ASSY, DISK,16"POLY
8.805-493.0	222307	BRUSH, SCRUB,32"18SR,STIFF POLY SPIRAL
8.805-494.0	222308	BRUSH, SCRUB,32"18SR,NYLON SPIRAL
8.805-495.0	222309	BRUSH, SCRUB,32"18SR,GRIT SPIRAL
8.805-503.0	374042	BRUSH, SCRUB,32"18SR, MED.POLY SPIRAL
8.805-532.0	397916	PAD DRIVER ASSY. 16"



Tennant - Nobles by Machine (con't)

GRACO#/Old Graco#	OEM	Description
Fits 7080 36"		
8.805-533.0	397918	PAD DRIVER ASSY. 18"
Fits 7100 28"		
8.805-490.0	222304	BRUSH, SCRUB, 28"18SR, POLY SPIRAL
8.805-491.0	222305	BRUSH, SCRUB, 28"18SR, NYLON SPIRAL
8.805-492.0	222306	BRUSH, SCRUB, 28"18SR, GRIT SPIRAL
8.805-499.0	222320	BRUSH ASSY, DISK,14" POLY
8.805-500.0	222321	BRUSH ASSY, DISK,14" NYLON
8.805-501.0	222322	BRUSH ASSY, DISK,14".060 GRIT
8.805-508.0	397914, 222323	PAD DRIVER ASSY. 14"
Fits 7100 32"		
8.805-515.0	05724	BRUSH ASSY, DISK, 16" NYLON
8.805-517.0	05726	BRUSH ASSY, DISK, 16" GRIT
8.805-466.0	30241	BRUSH ASSY, DISK,16"POLY
8.805-493.0	222307	BRUSH, SCRUB,32"18SR,STIFF POLY SPIRAL
8.805-494.0	222308	BRUSH, SCRUB,32"18SR,NYLON SPIRAL
8.805-495.0	222309	BRUSH, SCRUB,32"18SR,GRIT SPIRAL
8.805-503.0	374042	BRUSH, SCRUB,32"18SR, MED.POLY SPIRAL
8.805-532.0	397916	PAD DRIVER ASSY. 16"
8.805-739.0	1042499	BRUSH ASSY, DISC 16" NYLON
8.805-738.0	1042504	BRUSH ASSY, DISC, 16" GRIT
Fits 7100 36"		
8.805-463.0	11771	BRUSH ASSY, DISK,18" POLY
8.805-464.0	11772	BRUSH ASSY, DISK,18" GRIT
8.805-465.0	11773	BRUSH ASSY, DISK,18" NYLON
8.805-533.0	397918	PAD DRIVER ASSY. 18"
Fits 7200 28"		
8.805-490.0	222304	BRUSH, SCRUB, 28"18SR, POLY SPIRAL
8.805-491.0	222305	BRUSH, SCRUB, 28"18SR, NYLON SPIRAL
8.805-492.0	222306	BRUSH, SCRUB, 28"18SR, GRIT SPIRAL
Fits 7200 36"		
8.805-463.0	11771	BRUSH ASSY, DISK,18" POLY
8.805-464.0	11772	BRUSH ASSY, DISK,18" GRIT
8.805-465.0	11773	BRUSH ASSY, DISK,18" NYLON
8.805-496.0	222310	BRUSH, SCRUB,36"18SR, POLY SPIRAL
8.805-497.0	222311	BRUSH, SCRUB,36"18SR,NYLON SPIRAL
8.805-498.0	222312	BRUSH, SCRUB,36"18SR,GRIT SPIRAL
8.805-504.0	374043	BRUSH, SCRUB,36"18SR, POLY SPIRAL
Fits A5 32"		
8.805-494.0	222308	BRUSH, SCRUB,32"18SR,NYLON SPIRAL
8.805-495.0	222309	BRUSH, SCRUB,32"18SR,GRIT SPIRAL
8.805-503.0	374042	BRUSH, SCRUB,32"18SR, MED.POLY SPIRAL



Tennant - Nobles by Machine (con't)

GRACO#/Old Graco#	OEM	Description
Fits EZ Rider 28"		
8.805-490.0	222304	BRUSH, SCRUB, 28"18SR, POLY SPIRAL
8.805-491.0	222305	BRUSH, SCRUB, 28"18SR, NYLON SPIRAL
8.805-492.0	222306	BRUSH, SCRUB, 28"18SR, GRIT SPIRAL
8.805-499.0	222320	BRUSH ASSY, DISK,14" POLY
8.805-500.0	222321	BRUSH ASSY, DISK,14" NYLON
8.805-501.0	222322	BRUSH ASSY, DISK,14".060 GRIT
8.805-508.0	397914, 222323	PAD DRIVER ASSY. 14"
Fits EZ Rider 32"		
8.805-532.0	397916	PAD DRIVER ASSY. 16"
Fits EZ Rider HP 32"		
8.805-515.0	05724	BRUSH ASSY, DISK, 16" NYLON
8.805-517.0	05726	BRUSH ASSY, DISK, 16" GRIT
8.805-466.0	30241	BRUSH ASSY, DISK,16"POLY
8.805-493.0	222307	BRUSH, SCRUB,32"18SR,STIFF POLY SPIRAL
Fits M20		
8.805-509.0	1026222	BRUSH,SWEEP/SCRUB, 40" SUPER ABRASIVE
8.805-510.0	1026223	BRUSH,SWEEP/SCRUB, 40" POLY
8.805-737.0	1027688	BRUSH, SIDE POLY 24"
8.805-739.0	1042499	BRUSH ASSY, DISC 16" NYLON
8.805-738.0	1042504	BRUSH ASSY, DISC, 16" GRIT
Fits M30		
8.805-784.0	14953	BRUSH ASSY, DISK 20"POLY
8.805-785.0	14967	BRUSH ASSY, DISK 20" NYLON
8.805-737.0	1027688	BRUSH, SIDE POLY 24"
8.805-511.0	1033246	BRUSH,SWEEP/SCRUB, 48" 24SR POLYESTER
8.805-512.0	1033372	BRUSH,SWEEP/SCRUB, 48"SUPER ABRASIVE
8.805-513.0	1033374	BRUSH,SWEEP/SCRUB, 48" 24SR HD POLY
8.805-514.0	1033375	BRUSH,SWEEP/SCRUB, 48" 24SR POLY
8.805-739.0	1042499	BRUSH ASSY, DISC 16" NYLON
8.805-738.0	1042504	BRUSH ASSY, DISC, 16" GRIT
Fits S10		
8.805-788.0	28007P	BRUSH, SWEEP, 26" 6DR, POLY
Fits S20		
8.805-476.0	59431	BRUSH, SIDE SWEEP,23"DIA,POLY
8.805-477.0	59432	BRUSH, SIDE SWEEP,23"DIA, FLATWIRE
8.805-488.0	87097	BRUSH,SWEEP,36" POLY/WIRE
8.805-488.0	87097	BRUSH,SWEEP,36" POLY/WIRE
8.805-489.0	87099	BRUSH,SWEEP,36" POLY
8.805-516.0	05725, 1042500	BRUSH ASSY, DISK,16"STIFF POLY
8.805-518.0	08013N	BRUSH,SIDE SWEEP, 23"NYLON



Tennant - Nobles by Machine (con't)

GRACO#/Old Graco#	OEM	Description
Fits S30		
8.805-472.0	54922	BRUSH,SWEEP 45"-24SR,NYLON
8.805-473.0	54923	BRUSH,SWEEP 45"-8DR,NYLON
8.805-474.0	54925	BRUSH,SWP 45"8DR, POLY/WIRE, SPIRAL
8.805-475.0	54927	BRUSH,SWEEP 45"24SR FIBER/WIRE
8.805-478.0	59440	BRUSH,SWEEP, 45"8DR WIRE, SPIRAL
8.805-479.0	66019	BRUSH,SWEEP 45"-8DR,POLY SPIRAL
8.805-502.0	370008	BRUSH, SWEEP,45", WEDGE, POLY SPIRAL
Fits Speed Scrub 32"		
8.805-494.0	222308	BRUSH, SCRUB,32"18SR,NYLON SPIRAL
8.805-495.0	222309	BRUSH, SCRUB,32"18SR,GRIT SPIRAL
8.805-503.0	374042	BRUSH, SCRUB,32"18SR, MED.POLY SPIRAL
Fits Speed Scrub 28"		
8.805-490.0	222304	BRUSH, SCRUB, 28"18SR, POLY SPIRAL
8.805-491.0	222305	BRUSH, SCRUB, 28"18SR, NYLON SPIRAL
8.805-492.0	222306	BRUSH, SCRUB, 28"18SR, GRIT SPIRAL
Fits Speed Scrub 32"		
8.805-515.0	05724	BRUSH ASSY, DISK, 16" NYLON
8.805-517.0	05726	BRUSH ASSY, DISK, 16" GRIT
8.805-466.0	30241	BRUSH ASSY, DISK,16"POLY
8.805-494.0	222308	BRUSH, SCRUB,32"18SR,NYLON SPIRAL
8.805-495.0	222309	BRUSH, SCRUB,32"18SR,GRIT SPIRAL
8.805-503.0	374042	BRUSH, SCRUB,32"18SR, MED.POLY SPIRAL
Fits T15 36"		
8.805-463.0	11771	BRUSH ASSY, DISK,18" POLY
8.805-464.0	11772	BRUSH ASSY, DISK,18" GRIT
8.805-465.0	11773	BRUSH ASSY, DISK,18" NYLON
8.805-496.0	222310	BRUSH, SCRUB,36"18SR, POLY SPIRAL
8.805-497.0	222311	BRUSH, SCRUB,36"18SR,NYLON SPIRAL
8.805-498.0	222312	BRUSH, SCRUB,36"18SR,GRIT SPIRAL
8.805-504.0	374043	BRUSH, SCRUB,36"18SR, POLY SPIRAL
8.805-533.0	397918	PAD DRIVER ASSY. 18"



Tennant - Nobles by Machine (con't)

GRACO#/Old Graco#	OEM	Description
Fits T16		
8.805-787.0	87419	BRUSH, DISK, SWEEP, 19",POLY
Fits T16 36"		
8.805-463.0	11771	BRUSH ASSY, DISK,18" POLY
8.805-464.0	11772	BRUSH ASSY, DISK,18" GRIT
8.805-465.0	11773	BRUSH ASSY, DISK,18" NYLON
8.805-533.0	397918	PAD DRIVER ASSY. 18"
Fits T20		
8.805-499.0	222320	BRUSH ASSY, DISK,14" POLY
8.805-500.0	222321	BRUSH ASSY, DISK,14" NYLON
8.805-501.0	222322	BRUSH ASSY, DISK,14".060 GRIT
8.805-509.0	1026222	BRUSH,SWEEP/SCRUB, 40" SUPER ABRASIVE
8.805-510.0	1026223	BRUSH,SWEEP/SCRUB, 40" POLY
8.805-737.0	1027688	BRUSH, SIDE POLY 24"
8.805-739.0	1042499	BRUSH ASSY, DISC 16" NYLON
8.805-738.0	1042504	BRUSH ASSY, DISC, 16" GRIT
8.805-508.0	397914, 222323	PAD DRIVER ASSY. 14"
Fits T5 32"		
8.805-494.0	222308	BRUSH, SCRUB,32"18SR,NYLON SPIRAL
8.805-495.0	222309	BRUSH, SCRUB,32"18SR,GRIT SPIRAL
8.805-503.0	374042	BRUSH, SCRUB,32"18SR, MED.POLY SPIRAL
Fits T7 28"		
8.805-490.0	222304	BRUSH, SCRUB, 28"18SR, POLY SPIRAL
8.805-491.0	222305	BRUSH, SCRUB, 28"18SR, NYLON SPIRAL
8.805-492.0	222306	BRUSH, SCRUB, 28"18SR, GRIT SPIRAL
Fits T7 32"		
8.805-494.0	222308	BRUSH, SCRUB,32"18SR,NYLON SPIRAL
8.805-495.0	222309	BRUSH, SCRUB,32"18SR,GRIT SPIRAL
8.805-503.0	374042	BRUSH, SCRUB,32"18SR, MED.POLY SPIRAL

Brushes



Brushes



8.600-164.0



8.600-244.0



8.663-353.0

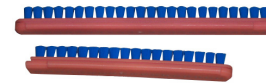

8.664-162.0



8.665-682.0



8.685-307.0



8.685-309.0

Brush Rollers & Strips

GRACO#/Old Graco#	OEM	Description	Fits
8.663-353.0	BRE-2	Brush Roller Assembly 12", Metal Hex Ends	Eureka, Sanitaire and others
8.664-162.0	BRE-4, VCP-18	Bristle Strip Orange, 12" Vibragroomer II Brush	Eureka, Sanitaire and others
8.665-682.0	VCP-19	Bristle Strip Black, 16" Vibragroomer I Brush	Eureka, Sanitaire and others
8.685-307.0	VCP-22	Brush Roller Assembly, 12" Hex Ends Vibragroomer I	Eureka, Sanitaire, and others
8.685-309.0	VCP-24	Brush Roller Assembly, 16" Hex Ends Vibragroomer I	
8.600-244.0	WV-7	Brush Strip 14" Versamatic	
8.600-164.0	WV-8	Brush Strip 18" Versamatic	



8.600-165.0



8.600-507.0



8.600-517.0



8.624-674.0



8.663-383.0



8.663-384.0



8.663-385.0



8.663-387.0

Center Pad Holder Devices

GRACO#/Old Graco#	OEM	Description	Fits
8.663-383.0	PH-3	Center Pad Holder, Press-in	
8.663-384.0	PH-3-P	Retainer Only for 8.663-383.0 (PH-3)	
8.663-385.0	PH-5	Center Lok II (R) RH Set Black (Male threaded retainer)	
8.663-387.0	PH-5-L	Center Lok II LH Set Red (Male threaded retainer)	
8.600-165.0	PH-7	Center Lok II (R) RH Set Black (Male threaded base)	
8.624-674.0	PH-6	Big Mouth Pad Holer RH Set Blue	
8.600-517.0	PH-6-L	Big Mouth Pad Holer LH Set	
8.600-507.0	PH-8	Pad Holder, Center Lock III, Snap-in	
8.684-881-0	PH-6-D	Pad Holder Donut, Provides Extra Grip for Center-Loc and Big Mouth Devices	



Brushes



9.848-069.0



8.628-435.0



8.660-712.0



8.661-848.0



8.684-499.0



8.805-520.0

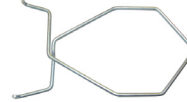

8.805-521.0



8.805-522.0



8.684-548.0

Clutch Plates & Brush Drive Devices

GRACO#/Old Graco#	OEM	Description	Fits
8.684-499.0	NP-47	Clutch Plate, for 5" center hole.	Older Advance units
8.628-435.0	NP-92	Clutch Plate, for 5" center hole.	Many makes, including newer Advance units
8.684-548.0	P-200	Clutch Plate, for 4" center hole.	Many makes, including newer Advance units
8.661-848.0	L-800	Brush Lock Stud.	Advance, Nobles and others
9.848-069.0	SC-84	Gimbal, Motor	Replaces Clarke 34400B
8.660-712.0	SC-82	Gimbal, Brush	Replaces Clarke 833802
8.805-520.0	24299	Bracket, Retainer Spring	Replaces Tennant 24299
8.805-521.0	14838	Spring, Wire 0.16D, Brush Retaining	Replaces Tennant 14838
8.805-522.0	15539	Hub, Drive, Brush, 3Hole 5.8BC [6T,	Replaces Tennant 15539

Brushes

Chains



Chains

Chains

GRACO#/Old Graco#	DESCRIPTION
8.663-392.0/ BLAL-9	Connecting Link #40
8.663-394.0/ BLAL-10	Offset Link #40
8.663-393.0/ BLC-35	Connecting Link #35
8.663-330.0/ BLC-450	50 ft. Bulk Chain #40
8.663-331.0 / BLC-3500	100 ft. Bulk Chain #35

American-Lincoln

GRACO#/Old Graco#	OEM	FITS
8.663-392.0/ BLAL-9	7-42-05016	Connecting Link #40
8.663-394.0/ BLAL-10	7-42-05015	Off Set Link #40
9.848-007.0/ BLAL-17	7-13-05061	934

Castex/Nobles

GRACO#/Old Graco#	OEM	FITS
9.848-122.0/ BLN-1	600426, 606777	2701, 3301
8.682-915.0/ BLTT-1	069-760-364	Servomatic 26, 32, S-261, S-262
8.688-056.0/ BLTT-2	611-054-000	260, 260XP, 320
8.660-657.0/ BLC-16	240071	Speedscrub 2700 series, 3300 series, Concorde HP

Clarke

GRACO# Old Graco#	OEM	FITS
8.663-392.0 BLAL-9	895158-4	Connecting Link No. 40
9.848-016.0 BLC-4	872461-9	TB-21
9.848-020.0 BLC-7	802450-7	TB-24
9.848-010.0 BLC-10	892452-4	TB-32
9.848-011.0 BLC-13	882406-2	BP-20
9.848-008.0 BLC-42	832416-2	TB-60-S, 2400-S (Only)
9.848-018.0 BLC-60	832402-2	TB-60, 80, 2400, 3200
9.848-447.0 BLC-61	52201A-6	Leader 2000B
9.848-013.0 BLC-81	52202A	Vision 21I, 26I, 26IX, 32I, 32IX, 38I

All Chain Assemblies Are Shipped With One Connecting Link.



BLAL-9



BLAL-10



BLC-35



BULK CHAIN

Hoover

GRACO#/Old Graco#	OEM	FITS
8.663-392.0/ BLAL-9	59187199	Connecting Link #40
8.663-393.0/ BLC-35	59187191	Connecting Link #35

Kent

GRACO#/Old Graco#	OEM	FITS
9.848-022.0/ BLK-8	51421	KA265B, KA325B

Nilfisk/Advance

GRACO# Old Graco#	OEM	FITS
8.670-032.0 BLA-83	56468884	Trac 280, 320, 380
9.848-003.0 BLA-84	56403172	Convertamatic 32BD, 38BD
9.848-005.0 BLA-86	56395871	Convertamatic 32B, BD, 38BD
9.848-006.0 BLA-87	56393172	Trac 240
8.682-825.0 BLA-88	56324027	Convertamatic 200,B,BD,LX
8.663-392.0 BLAL-9	56445096	#40 Connecting Link
8.660-657.0 BLC-16	56741122/ 56388688	Convertamax 20, 26
8.682-897.0 BLK-9	56048143	#35 69 LK & CONN

NSS

GRACO#/Old Graco#	OEM	FITS
8.663-392.0/ BLAL-9	27-521-1	Connecting Link
9.848-023.0/ BLNS-4	27-034-1	Wrangler 27
9.848-024.0/ BLNS-5	33-040-1	Wrangler 33
9.848-325.0/ BLNS-8	3392949	Wrangler 2730, 3330
9.848-453.0/ BLNS-7	2694061	



Lester Battery Chargers Semi-Automatic Timer

GRACO# Old Graco#	MFG	DC VOLTS	DC AMPS	BATTERY AMP HR CAP (12 HR)
8.671-969.0 CH-41	9200	24	10	90-140
8.683-211.0 CH-42	6730	24	20	135-220
8.663-205.0 CH-8	13175	24	25	210-300
8.683-202.0 Ch-30	8781	24	40	230-350
8.683-213.0 CH-62	6720	36	20	135-220
8.663-221.0 CH-7	9611	36	25	210-300



8.673-803.0



8.673-801.0



8.660-092.0



8.663-218.0

Lester Battery Chargers Automatic Timer

GRACO# Old Graco#	MFG	DC VOLTS	DC AMPS	BATTERY AMP HR CAP (12 HR)
8.660-092.0* CH-10*	18360	24	12	90-140
8.673-801.0 CH-31	9800	24	20	135-220
8.663-215.0 CH-32	7210	24	25	210-300
8.673-803.0 CH-63	9700	36	20	135-220
8.673-802.0 CH-38	7710	36	25	210-300
8.663-213.0 CH-40	9475	36	40	250-370
8.806-293.0 CH-32SCR	26040	24	25	210-300
8.663-218.0 CH-31SCR		24	20	135-220
CH-31SCRs		24	20	for Sealed Batteries
8.663-210.0 CH-38SCR		36	20	210-300
CH-38SCRs		36	25	for Sealed Batteries
8.663-220.0 CH-63SCR		36	20	135-220
CH-31SCRs		36	20	for Sealed Batteries

* Works on Wet Cell and Sealed Cell Batteries (Replaced 13115)

Motor Appliance Chargers Automatic Timer

GRACO# Old Graco#	MFG	DC VOLTS	DC AMPS	BATTERY AMP HR CAP (12 HR)
8.683-200.0 CH-24	V-24	24	20	135-220
8.671-968.0 CH-36	V-36	36	20	135-220
8.683-206.0 CH-37	V-360	36	25	210-300



8.663-214.0

Dayton Battery Charger Manual

GRACO# Old Graco#	MFG	DC VOLTS	DC AMPS	BATTERY AMP HR CAP (12 HR)
8.663-214.0 CH-12		12	10	



8.679-059.0

Delta-Q

GRACO#	VOLTS	DC AMPS	DC DESCRIPTION
8.679-059.0	24	21	Charger - Onboard Replaces: Clarke 40739B

**See Ordering Guide to
Specify Charger and Plug**



8.663-408.0

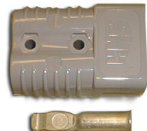

8.600-876.0



8.623-336.0

See Ordering Guide to Specify Charger and Plug

Chargers

Plugs & Plug Housings

GRACO# Old Graco#	DESCRIPTION
50A 8.663-408.0 CHP-2	50 Amp Charger Plug & Contacts (Gray) L: 1-7/8" W: 1-1/2" H: 7/16"
9.848-026.0 CHP-2-I	50 Amp Charger Plug Assembly w/10 GA Wire Inserts (Gray)
8.663-411.0 CHP-2-R	50 Amp Charger Plug & Contacts (Red)
8.663-406.0 CHP-7	50 Amp Charger Plug Housing Only (Gray)
8.663-400.0 CHP-7-R	50 Amp Charger Plug Housing Only (Red)
8.663-335.0 CHP-8	Retainer Clamp (for 50 Amp)
8.683-222.0 CHP-17	10 Gauge Wire Insert (for 50 Amp)
120A 8.689-342.0	120 Amp Charger Plug w/Terminals (Gray) 2-1/2" x 1-3/4"
8.678-110.0	120 Amp Charger Plug, w/Terminals (Red) 2-1/2" x 1-3/4"

Plugs & Plug Housings (cont)

GRACO# Old Graco#	DESCRIPTION
175A 8.806-825.0 CHP-3	175 Amp Charger Plug & Contacts (Gray) L: 3" W: 2-1/8" H: 1"
8.806-824.0 CHP-3-R	175 Amp Charger Plug & Contacts (Red)
8.660-973.0 CHP-9	175 Amp Charger Plug Housing Only (Grey)
8.664-079.0 CHP-9-R	175 Amp Charger Plug Housing Only (Red)
8.623-336.0 CHP-13	Retainer Clamp (for 175 Amp)
350A CHP-350	350 Amp Charger Plug (Gray) L: 4-1/4" W: 2-3/4" H: 1-1/4"
CHP350R	350 Amp Charger Plug (Red) L: 4-1/4" W: 1-3/4" H: 1-1/4"

Graco makes Charger & Battery Cable Assemblies to fit your specifications.



8.683-226.0



8.683-227.0



9.848-316.0



9.848-038.0

Special Cord Assemblies

GRACO#/Old Graco#	OEM	DESCRIPTION	TO FIT
8.683-226.0/ CHP-1-AG	56386118	D.C. Cord Assy (Grey Plug)	All Chargers w/ Two Blade Plug (Grey)
8.683-227.0/ CHP-1-AY		D.C. Cord Assy (Yellow Plug)	All Chargers w/ Two Blade Plug (Yellow)
9.848-029.0/ CHP-175A		D.C. Cord w/175 Amp Plug	All Chargers (Specify Red or Gray Plug)
9.848-330.0/ CHP-2-A	908818	D.C. Cord w/50 Amp Plug	All Chargers (Specify Red or Gray Plug)
9.848-446.0/ CHP-2-ANS	27-209-1	Charger Plug w/wire	NSS Wrangler
9.848-316.0/ CHP-3-A	56364194	Charger Plug w/cable	Advance Convertamatic
9.848-037.0/ CHP-4-A	41122A	Cable Assembly Console	Leader Series II
9.848-317.0/ CHP-5-A	41201A	Cable Assembly Battery	Leader Series II
9.848-141.0/ CHP-9-A	56324307	Adaptor Plug Assy	Convertamatic 200B, 200BD, 200LX, 20B
9.848-030.0/ CHP-18	56391161	Connector - Assembly Battery	Advance Trac Series Scrubbers
9.848-445.0/ CHP-19	56261237	Connector - Assembly Battery	Advance Trac Series Scrubbers
9.848-147.0/ CHP-25-A	41146A	Console Cable Assy	Vision 21, Encore 20, Focus 17/20, Encore 24-26
9.848-113.0/ CHP-26-A	41140A	Console Cable Assy	Encore 28, 33, 38, Vision 26, 32, 38
9.848-149.0/ CHP-27-A	41211A	Battery Cable Assy	Vision 21, Encore 20
9.848-115.0/ CHP-28-A	41208A	Battery Cable Assy	Encore 28, 33, 38, Vision 26, 32, 38
9.848-116.0/ CHP-29-A	41206A	Battery Cable Series	Encore 20, 38, 33, 38
9.848-038.0/ ETK-1		Charger Test Kit	As Pictured above
9.848-048.0/ ETK-1-R		Same As Above w/SB-50 Red Plug	As Pictured above



OEM Interchange: Charger Ordering Guide

GRACO#/Old Graco#	MFG	DC VOLTS	DC AMPS	BATTERY STYLE	BATTERY AMP HOUR RANGE	CHARGER STYLE	PLUG RATING	PLUG COLOR
8.663-214.0/CH-12	DAYTON	12V	10A	WET	90-140	AUTO	NO PLUG	NO PLUG
8.671-969.0/CH-41	LESTER	24V	10A	WET	90-140	W/TIMER	2 BLADE	YELLOW
9.848-366.0/CH-41350R	LESTER	24V	10A	WET	90-140	W/TIMER	350A	RED
9.848-376.0/CH-4150R	LESTER	24V	10A	WET	90-140	W/TIMER	50A	RED
9.848-333.0/CH-10175R	LESTER	24V	12A	WET/SEALED	90-140	SCR DUAL MODE	175A	RED
9.848-334.0/CH-10350R	LESTER	24V	12A	WET/SEALED	90-140	SCR DUAL MODE	350A	RED
9.848-332.0/CH-1050G	LESTER	24V	12A	WET/SEALED	90-140	SCR DUAL MODE	50A	GRAY
8.660-092.0/CH-1050R	LESTER	24V	12A	WET/SEALED	90-140	SCR DUAL MODE	50A	RED
9.848-389.0/CH-31SCR175RS	LESTER	24V	20A	SEALED	135-220	SCR, AUTO	175A	RED
9.848-390.0/CH-31SCR350RS	LESTER	24V	20A	SEALED	135-220	SCR, AUTO	350A	RED
9.848-387.0/CH-31SCR50GS	LESTER	24V	20A	SEALED	135-220	SCR, AUTO	50A	GRAY
9.848-388.0/CH-31SCR50RS	LESTER	24V	20A	SEALED	135-220	SCR, AUTO	50A	RED
9.848-348.0/CH-31175R	LESTER	24V	20A	WET	135-220	AUTO	175A	RED
9.848-351.0/CH-31SCR175R	LESTER	24V	20A	WET	135-220	SCR, AUTO	175A	RED
9.848-380.0/CH-42175R	LESTER	24V	20A	WET	135-220	W/TIMER	175A	RED
9.848-349.0/CH-31350R	LESTER	24V	20A	WET	135-220	AUTO	350A	RED
9.848-352.0/CH-31SCR350R	LESTER	24V	20A	WET	135-220	SCR, AUTO	350A	RED
9.848-381.0/CH-42350R	LESTER	24V	20A	WET	135-220	W/TIMER	350A	RED
8.663-218.0/CH-31SCR50R	LESTER	24V	20A	WET	135-220	SCR, AUTO	50A	RED
8.683-211.0/CH-4250G	LESTER	24V	20A	WET	135-220	W/TIMER	50A	GRAY
9.848-347.0/CH-3150R	LESTER	24V	20A	WET	135-220	AUTO	50A	RED
9.848-350.0/CH-31SCR50G	LESTER	24V	20A	WET	135-220	SCR, AUTO	50A	GRAY
9.848-379.0/CH-4250R	LESTER	24V	20A	WET	135-220	W/TIMER	50A	RED
8.673-801.0/CH-31	LESTER	24V	20A	WET	135-220	AUTO	NO PLUG	NO PLUG
9.848-368.0/CH-24175R	M.A.C.	24V	20A	WET	135-220	AUTO	175A	RED
9.848-369.0/CH-24350R	M.A.C.	24V	20A	WET	135-220	AUTO	350A	RED
8.683-200.0/CH-2450G	M.A.C.	24V	20A	WET	135-220	AUTO	50A	GRAY
9.848-367.0/CH-2450R	M.A.C.	24V	20A	WET	135-220	AUTO	50A	RED
9.848-345.0/CH-32175R	LESTER	24V	25A	WET	210-315	AUTO	175A	RED
9.848-636.0/CH-32175G	LESTER	24V	25A	WET	210-315	AUTO	175A	GRAY
9.848-336.0/CH-8175R	LESTER	24V	25A	WET	210-315	W/TIMER	175A	RED
9.848-346.0/CH-32350R	LESTER	24V	25A	WET	210-315	AUTO	350A	RED
9.848-337.0/CH-8350R	LESTER	24V	25A	WET	210-315	W/TIMER	350A	RED
9.848-344.0/CH-3250R	LESTER	24V	25A	WET	210-315	AUTO	50A	RED
9.848-335.0/CH-850R	LESTER	24V	25A	WET	210-315	W/TIMER	50A	RED
8.663-215.0/CH-32	LESTER	24V	25A	WET	210-315	AUTO	NO PLUG	NO PLUG
8.663-205.0/CH-8	LESTER	24V	25A	WET	210-315	W/TIMER	NO PLUG	NO PLUG
9.848-371.0/CH-30175R	LESTER	24V	40A	WET	230-350	W/TIMER	175A	RED
9.848-372.0/CH-30350R	LESTER	24V	40A	WET	230-350	W/TIMER	350A	RED
9.848-370.0/CH-3050R	LESTER	24V	40A	WET	230-350	W/TIMER	50A	RED
8.683-202.0/CH-30	LESTER	24V	40A	WET	230-350	W/TIMER	NO PLUG	NO PLUG

OEM Interchange

OEM Interchange: Charger Ordering Guide



OEM Interchange

GRACO#/Old Graco#	MFG	DC VOLTS	DC AMPS	BATTERY STYLE	BATTERY AMP HOUR RANGE	CHARGER STYLE	PLUG RATING	PLUG COLOR
9.848-363.0/CH-36175G	M.A.C.	36V	20A	WET	135-220	AUTO	175A	GRAY
9.848-364.0/CH-36350G	M.A.C.	36V	20A	WET	135-220	AUTO	350A	GRAY
8.671-968.0/CH-3650G	M.A.C.	36V	20A	WET	135-220	AUTO	50A	GRAY
9.848-382.0/CH-62175G	LESTER	36V	20A	WET	135-220	W/TIMER	175A	GRAY
9.848-383.0/CH-62350G	LESTER	36V	20A	WET	135-220	W/TIMER	350A	GRAY
8.683-213.0/CH-6250G	LESTER	36V	20A	WET	135-220	W/TIMER	50A	GRAY
9.848-354.0/CH-63175G	LESTER	36V	20A	WET	135-220	AUTO	175A	GRAY
9.848-355.0/CH-63350G	LESTER	36V	20A	WET	135-220	AUTO	350A	GRAY
9.848-353.0/CH-6350G	LESTER	36V	20A	WET	135-220	AUTO	50A	GRAY
8.663-220.0/CH-63SCR	LESTER	36V	20A	WET	135-220	SCR, AUTO	50A	GRAY
9.848-356.0/CH-63SCR175G	LESTER	36V	20A	WET	135-220	SCR, AUTO	175A	GRAY
9.848-392.0/CH-63SCR175GS	LESTER	36V	20A	SEALED	135-220	SCR, AUTO	175A	GRAY
9.848-357.0/CH-63SCR350G	LESTER	36V	20A	WET	135-220	SCR, AUTO	350A	GRAY
9.848-393.0/CH-63SCR350GS	LESTER	36V	20A	SEALED	135-220	SCR, AUTO	350A	GRAY
9.848-391.0/CH-63SCR50GS	LESTER	36V	20A	SEALED	135-220	SCR, AUTO	50A	GRAY
9.848-362.0/CH-3650R	M.A.C.	36V	20A	WET	135-220	AUTO	50A	RED
8.673-803.0/CH-63	LESTER	36V	20A	WET	135-220	AUTO	NO PLUG	NO PLUG
9.848-374.0/CH-37175G	M.A.C.	36V	25A	WET	210-315	AUTO	175A	GRAY
9.848-375.0/CH-37350G	M.A.C.	36V	25A	WET	210-315	AUTO	350A	GRAY
8.683-206.0/CH-3750G	M.A.C.	36V	25A	WET	210-315	AUTO	50A	GRAY
9.848-338.0/CH-38175G	LESTER	36V	25A	WET	210-315	AUTO	175A	GRAY
9.848-339.0/CH-38350G	LESTER	36V	25A	WET	210-315	AUTO	350A	GRAY
8.673-802.0/CH-3850G	LESTER	36V	25A	WET	210-315	AUTO	50A	GRAY
9.848-340.0/CH-38SCR175G	LESTER	36V	25A	WET	210-315	SCR, AUTO	175A	GRAY
9.848-385.0/CH-38SCR175GS	LESTER	36V	25A	SEALED	210-315	SCR, AUTO	175A	GRAY
9.848-341.0/CH-38SCR350G	LESTER	36V	25A	WET	210-315	SCR, AUTO	350A	GRAY
9.848-386.0/CH-38SCR350GS	LESTER	36V	25A	SEALED	210-315	SCR, AUTO	350A	GRAY
8.663-210.0/CH-38SCR50G	LESTER	36V	25A	WET	210-315	SCR, AUTO	50A	GRAY
9.848-384.0/CH-38SCR50GS	LESTER	36V	25A	SEALED	210-315	SCR, AUTO	50A	GRAY
9.848-359.0/CH-7175G	LESTER	36V	25A	WET	210-315	W/TIMER	175A	GRAY
9.848-360.0/CH-7350G	LESTER	36V	25A	WET	210-315	W/TIMER	350A	GRAY
9.848-358.0/CH-750G	LESTER	36V	25A	WET	210-315	W/TIMER	50A	GRAY
9.848-373.0/CH-3750R	M.A.C.	36V	25A	WET	210-315	AUTO	50A	RED
8.663-221.0/CH-7	LESTER	36V	25A	WET	210-315	W/TIMER	NO PLUG	NO PLUG
9.848-342.0/CH-40175G	LESTER	36V	40A	WET	250-370	AUTO	175A	GRAY
9.848-343.0/CH-40350G	LESTER	36V	40A	WET	250-370	AUTO	350A	GRAY
8.663-213.0/CH-4050G	LESTER	36V	40A	WET	250-370	AUTO	50A	GRAY



Charger Plug Handles

GRACO#/Old Graco#	Description
8.683-240.0/ CHP-2H	Handle for CHP-2 (Gray Plastic)
8.671-970.0/ CHP-2-RH	Handle for CHP-2 (Red Plastic)

GRACO#/Old Graco#	Description
8.663-390.0/ CHP-3H	Handle for CHP-3 (Gray Plastic)
8.671-971.0/ CHP-3-RH	Handle for CHP-3 (Red Plastic)

**GRACO
spotlight**



8.683-240.0

Charger Plug Handles

Keep your power cord safe and secure with attachable Charger Handles!

Easy to attach
Attaches to charger plug
Affordable and convenient
Fits *all* chargers



8.663-390.0

Chargers



8.663-731.0

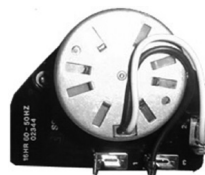

8.683-219.0



8.663-730.0

Lester

MODEL#	GRACO#/Old Graco#	AMMETER#/OLD#	CAPACITOR#/OLD#	CORD STRAIN	
				RELIEF AC#/OLD#	RELIEF DC#/OLD#
6720	8.683-213.0/ CH-62	8.663-731.0/ CHP-10	8.683-231.0/ CHP-2390	8.663-333.0/ 03894S	
6730	8.683-211.0/ CH-42	8.663-731.0/ CHP-10	8.683-231.0/ CHP-2390	8.663-333.0/ 03894S	
7210	8.663-215.0/ CH-32	8.608-793.0/ 04127S	8.683-231.0/ CHP-2390		
7710	8.673-802.0/ CH-38	8.663-731.0/ CHP-10	8.683-231.0/ CHP-2390	8.663-333.0/ 03894S	
8781	8.683-202.0/ CH-30	8.663-731.0/ CHP-10	8.683-231.0/ CHP-2390		
9080	CH-39		8.683-231.0/ CHP-2390		
9200	8.671-969.0/ CH-41		8.664-414.0/ 03820S	8.663-333.0/ 03894S	8.663-333.0/ 03894S
9475	8.663-213.0/ CH-40		8.683-231.0/ CHP-2390		
9611	8.663-221.0/ CH-7	8.663-731.0/ CHP-10	8.683-231.0/ CHP-2390		
9700	8.673-803.0/ CH-63	8.663-731.0/ CHP-10	8.683-231.0/ CHP-2390		
9800	8.673-801.0/ CH-31	8.663-731.0/ CHP-10	8.683-231.0/ CHP-2390		
13115	8.660-092.0/ CH-10	8.662-169.0/ 02534S	8.664-414.0/ 03820S	8.663-333.0/ 03894S	8.663-333.0/ 03894S
13175	8.663-205.0/ CH-8	8.663-731.0/ CHP-10	8.683-231.0/ CHP-2390		
13810	8.671-709.0/ CH-44				



CPT-8617

M.A.C.

MODEL #	GRACO#/Old Graco#	AMMETER	RELIEF DC
TR-36	CALL	CPT-8617	CPT-7996
TR-360	CALL	CPT-8617	CPT-7996
V-36	8.671-968.0/ CH-36	CPT-9818	CPT-7996
V-360	8.683-206.0/ CH-37	CPT-9818	CPT-7996
V-24	8.683-200.0/ CH-24	CPT-9818	CP-11641
V-240	8.663-216.0/ CH-25	CPT-9818	CP-11641

We Stock Popular Parts for Lester and M.A.C. Chargers. Any Items not Stocked can be Ordered

Chargers: Parts Reference



8663-730.0



8.683-220.0



8.680-011.0



8.683-219.0



8.663-732.0



8.683-252.0



8.663-733.1

Chargers

Lester

MODEL#	FUSE# OLD FUSE#	FUSE HOLDER# OLD FUSE HOLDER#	HEAT SINK ASSY# OLD HEAT SINK ASSY#	DIODE# OLD DIODE#	TIMER# OLD TIMER#	TIMER KNOB# OLD TIMER KNOB#
6720	8.663-730.0 CHP-8776	CALL	8.663-732.0 CHP-22	CALL	8.683-219.0 CHP-14	8.683-221.0 CHP-16
6730	8.663-730.0 CHP-8776	CALL	8.663-732.0 CHP-22	CALL	8.683-218.0 CHP-14	8.683-221.0 CHP-16
7210	8.663-730.0 CHP-8776	CALL	8.663-732.0 CHP-22	CALL		CALL
7710	8.663-730.0 CHP-8776	CALL	8.663-732.0 CHP-22	8.685-710.0 CHP-23	8.680-011.0 06357S	CALL
8781	8.680-012.0 08774S	CALL	8.663-732.0 CHP-22	CALL	8.683-218.0 CHP-14	8.683-221.0 CHP-16
9080	8.680-012.0 08774S	CALL		CALL	8.683-218.0 CHP-14	8.683-221.0 CHP-16
9200		8.685-757.0 03837S	8.663-732.0 CHP-22	CALL	8.683-218.0 CHP-14	8.683-221.0 CHP-16
9475	8.680-012.0 08774S	CALL		08849S		CALL
9611	8.663-730.0 CHP-8776	CALL	8.663-732.0 CHP-22	*	8.683-218.0 CHP-14	8.683-221.0 CHP-16
9700	8.663-730.0 CHP-8776	CALL	8.663-732.0 CHP-22	*		CALL
9800	8.663-730.0 CHP-8776	CALL	8.663-732.0 CHP-22	*		CALL
13115		8.685-757.0 03837S	8.663-732.0 CHP-22	*		CALL
13175	8.663-730.0 CHP-8776	CALL	8.663-732.0 CHP-22	*	8.683-214.0 CHP-14	8.683-221.0 CHP-16
13810		CALL	8.663-732.0 CHP-22			
			8.683-220.0 CHP-15			

M.A.C.

MODEL # Old Graco#	FUSE# OLD FUSE#	FUSE HOLDER#	HEAT SINK ASSY#	TIMER# OLD TIMER#	TIMER KNOB#
TR-36	8.060-974.0 CPT-1374	CALL		CPT-7489	CPT-7794
TR-360	8.060-974.0 CPT-1374			CPT-7489	CPT-9231
V-36	8.060-974.0 CPT-1374	CALL	CALL	CALL	
V-360	8.060-974.0 CPT-1374	CALL	CALL	CALL	
V-24	8.060-974.0 CPT-1374	CALL	CALL	CALL	
V-240	8.060-974.0 CPT-1374	CALL	CALL	CALL	



Cords: Cords and Connectors



8.663-327.0

25 Feet

GRACO#/Old Graco#	CORD TYPE	COLOR	VOLTAGE RATING
8.663-327.0/ E-621	16/3 SJTW	Orange	300



8.613-551.0

40 Feet

GRACO#/Old Graco#	CORD TYPE	COLOR	VOLTAGE RATING
8.613-551.0/ WV-26	18/3 SJT	Blue	300
8.665-293.0/ E-40Y	18/35JT	Yellow	300



8.672-023.0

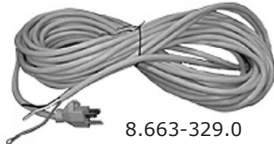

8.663-329.0

50 Feet

GRACO#/Old Graco#	CORD TYPE	COLOR	VOLTAGE RATING
8.672-023.0/ E-251	12/3 SJTW	Orange	300
8.663-345.0/ E-451	14/3 SJTW	Orange	300
8.661-719.0/ E-452R	14/3 ST	Red	600
8.623-411.0/ E-452Y	14/3 ST	Yellow	600
8.685-694.0/ E-452G	14/3 ST	Gray	600
8.683-314.0/ E-651	16/3 SJTW	Orange	300
8.663-329.0/ VCP-6	18/3 SJT	Beige	300
8.663-328.0/ VCP-7	18/3 SJT	Black	300



8.663-348.0

75 Feet

GRACO#/Old Graco#	CORD TYPE	COLOR	VOLTAGE RATING
8.663-348.0/ E-4752R	14/3 ST	Red	600
8.669-550.0/ E-4752Y	14/3 ST	Yellow	600



8.661-718.0

100 Feet

GRACO#/Old Graco#	CORD TYPE	COLOR	VOLTAGE RATING
8.661-718.0/ E-2101	12/3 SJTW	Orange	300
8.663-346.0/ E-4101	14/3 SJTW	Orange	300



8.663-320.0

Armored Construction

GRACO#/Old Graco#	3 PRONG CORD TYPE	VOLTAGE RATING
8.663-320.0/ E-71	Plug (M)	15A - 125V
8.663-321.0/ E-72	Connector (F)	15A - 125V



8.663-448.0



8.663-318.0

Nylon Construction - Standard 3 Prong

GRACO#/Old Graco#	3 PRONG CORD TYPE	VOLTAGE RATING
8.663-448.0/ E-73	Plug (M)	15A - 125V
8.663-319.0/ E-74	Connector (F)	15A - 125V
8.660-962.0/ E-80	Hospital Plug (M)	15A - 125V
8.663-449.0/ E-87	Hospital Plug (F)	15A - 125V

Cords: Connectors and Accessories



Plug
8.663-326.0



Connector
8.663-324.0



Ground Adapter
8.683-321.0



Nylon Strain Relief
8.683-336.0



GFCI Cord
8.683-335.0

Nylon Construction - Twist Lock 3 Prong

GRACO#/Old Graco#	CORD TYPE	VOLTAGE RATING
8.663-326.0/ E-75	Plug (M)	20A - 125V
8.663-395.0/ E-76	Connector (F)	20A - 125V
8.663-325.0/ E-78	Plug (Male)	15A - 125V
8.663-324.0/ E-79	Connector (F)	15A - 125V

Cord Accessories

GRACO# Old Graco#	Description	VOLTAGE RATING
8.663-336.0 E-88	Nylon Strain Relief .17" to .47"	
8.663-972.0 E-89	Nylon Strain Relief .23" to .395"	
8.683-336.0 E-91	Nylon Strain Relief .5460D w/Lock Nut	
8.683-321.0 E-90	GFCI Cord	125V - 15A
8.683-321.0 E-77	Ground Adapter (Gray Vinyl)	15A - 125V

Cords

GRACO
spotlight

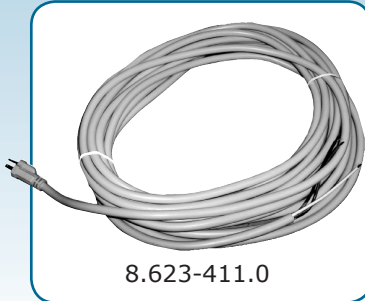

8.623-411.0

High Visibility Cords

8.623-411.0
14/3 ST Cord Type
600 Volt
50' Heavy Duty
Yellow

8.669-550.0
14/3 ST Cord Type
600 Volt
75' Heavy Duty
Yellow

8.665-293.0
18/3 SJT Cord Type
300 Voltage Rating
40' Heavy Duty
Yellow

Also Available in Red - 8.661-719.0 & 8.663-348.0



9.848-436.0



9.848-435.0



8.660-903.0

Clarke - BOOST Isolator Mount Kits

GRACO# Old Graco#	OEM	FITS
9.848-436.0	56380236, 54445A	Isolator Kit, BOOST 20
9.848-435.0	56380235, 11063B, 11062A	Isolator Kit, BOOST 28-32, BOOST Rider, Focus II Mid-Size

Clarke - Gear Unit

GRACO# Old Graco#	OEM	FITS
8.660-903.0 BLC-24	54238A	Encores, Visions



8.660-331.0

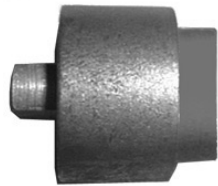

8.663-739.0



8.663-740.0

Clarke - Miscellaneous

GRACO# Old Graco#	OEM	FITS
8.660-331.0 MC-29	60154A	Drive Wheel Axle for Vision

Clarke - Drive Couplings

GRACO# Old Graco#	OEM	FITS
8.663-739.0 BLC-30	502404	Clarke FM (Metal)
8.663-740.0 BLC-40	442473	Clarke C Buffers & many Buffers (Plastic)



8.664-218.0



8.660-657.0

Misc - Flange, Drive Hub

GRACO# Old Graco#	OEM	FITS
8.664-218.0	1355 56102517	Eagle, Advance, and other Propane Burnishers



8.664-214.0

Clarke - Drive Sprockets

GRACO# Old Graco#	OEM	FITS
8.660-657.0 BLC-16	898550	Motor Drive-24", 26", 32" Scrubbers w/ #40 Type Chain

Misc - Pulley, Idler 4"

GRACO# Old Graco#	OEM	FITS
8.665-214.0	1235 56102519	Eagle, Advance Pro27, and others



8.665-027.0



Misc - Bearing/Shaft Assy Front Housing

GRACO# Old Graco#	OEM	FITS
8.665-027.0	56102509 1373	Eagle, Advance, and others



8.666-909.0

Tennant - Shaft, Drive Wheel

GRACO# Old Graco#	OEM	FITS
8.666-909.0	230205	5540, 5560 Scrubber, Speed Scrub 2700, Speed Scrub 2701 (Built Before 2001), Speed Scrub 2701 w/FaST (Built 2001-2007), Speed Scrub 3300, Speed Scrub 3301 (Built Before 2001), Speed Scrub 3301 w/FaST (Built 2001-2007)



8.688-505.0

Tennant - Sprocket 40A39 x 1.75

GRACO# Old Graco#	OEM	FITS
8.688-505.0	240070	5540 Scrubber, 5560 Scrubber, Speed Scrub 2700, Speed Scrub 2701 (Built Before 2001), Speed Scrub 2701 w/FaST (Built 2001-2007), Speed Scrub 3300, Speed Scrub 3301 (Built Before 2001), Speed Scrub 3301 w/FaST (Built 2001-2007)

Tennant - Sprocket 1/4" Keyway, 3/4" Tooth

GRACO# Old Graco#	OEM	FITS
8.685-711.0	240071	1550 Extractor, 5540, 5560 Scrubber, Concorde HP Plus, Concorde HP, Speed Scrub 2700, 2701, SS2700, Speed Scrub 2701 w/FaST (Built 2001-2007), Speed Scrub 3300, SS3300, Speed Scrub 3301 (Built Before 2001), Speed Scrub 3301 w/FaST (Built 2001-2007), Tuffscrub 3300 Rider Scrubber



Capacitors

GRACO# Old Graco#	Description / Specifications
8.662-022.0 EA-61	M-20 Capacitor - 4CU46 (430-516 MFD) Nilfisk/Advance
8.663-467.0 EA-64	Capacitor W12 1200 MFD Blue Nilfisk/Advance
8.683-231.0 CHP-2390	Capacitor GMFD Clarke



8.663-022.0



8.663-467.0



8.683-231.0

GRACO
spotlight



8.806-221.0

Speed Controller

8.806-221.0

OEM: 56314067

Fits: Advance Adhancer, Advenger, Advenger Axp,
Br600s, Br700s, Br800s

Electical Parts

Circuit Breakers - Style A

GRACO#/Old Graco#	Specifications	Terminal Type
8.663-470.0/ EB-38	38 Amp	Push - On



Style A

Circuit Breakers - Style B



Style B

GRACO#/Old Graco#	Specifications	Terminal Type
8.660-827.0/ EA-16	1.5 Amp	Push - On
8.660-200.0/ EA-22	3 Amp	
8.660-822.0/ EA-51	5 Amp	Push - On
8.663-368.0/ EA-23	6 Amp	Push - On
8.660-893.0/ EA-72	10 Amp	Push - On
8.661-874.0/ EA-34	15 Amp	Push - On
8.660-851.0/ EA-24	17 Amp	Push - On

GRACO#/Old Graco#	Specifications	Terminal Type
8.660-828.0/ EA-18	18 Amp	Push - On
8.660-975.0/ EA-33	20 Amp	Push - On
8.663-367.0/ EB-14	32 Amp	Push - On
8.660-829.0/ ETN-4	25 Amp	Screw
8.660-191.0/ EA-29	30 Amp	Screw
8.660-891.0/ EA-35	35 Amp	Screw
8.660-951.0/ EA-45	45 Amp	Screw
8.660-852.0/ EA-50	50 Amp	Screw
8.660-853.0/ EA-70	70 Amp	Screw
8.660-890.0/ EA-71	60 Amp	Screw

Electical Parts



8.663-320.0



9.848-613.0



8.663-401.0



8.660-863.0



8.672-077.0



8.660-222.0



8.684-502.0

Electical Plugs & Connectors

GRACO#/Old Graco#	Specifications
8.663-320.0/ E-71	3 Pronged Armored Plug (Male)
8.663-321.0/ E-72	3 Prong Armored Plug (Female)
8.663-448.0/ E-73	3 Prong Nylon Cap
8.663-319.0/ E-74	3 Prong Nylon Connector
8.663-326.0/ E-75	Twist Lock Cap (Male) 20 Amp
8.663-395.0/ E-76	Twist Lock Connector (Female) 20 Amp
8.683-321.0/ E-77	Adapter 419-GY-BU (Ground)
8.663-325.0/ E-78	15 Amp Twist Lock Cap (Male)
8.663-324.0/ E-79	15 Amp Twist Lock Connector (Female)
8.660-962.0/ E-80	Hospital Grade Plug (Male)
8.848-613.0/ E-82	Connector 60 Amp - Blue Housing and Terminal
8.660-688.0/ E-83	Connector-Housing
8.663-401.0/ E-84	Connector-Contact 6 Gauge for 50 and 125 Amp plugs
8.683-330.0/ E-85	Housing Connector Blue
8.683-331.0/ E-86	Housing Connector Black
8.663-449.0/ E-87	3 Prong Female Hospital Plug



8.672-034.0

Fuses

GRACO#/Old Graco#	Specifications
8.672-034.0/ EA-93	150 Amp Fuse
8.683-267.0/ CP-11641	Fuse
8.660-953.0/ CP-11641	15 Amp Fuse
8.660-974.0/ CPT-1374	Front Mount Fuse Holder
8.663-730.0/ CPT-1374	Fuse - Lester

Fuses

GRACO#/Old Graco#	Specifications
8.660-863.0/ APL-1	Indicator Light (Green) 24 Volt / 36 Volt
8.672-077.0/ KPL-1	Red Pilot Light
8.661-845.0/ EA-91	Indicator Light - Blue 28V
8.672-077.0/ KPL-1	Red Pilot Light
8.660-222.0/ NPL-1	Indicator - Light Green
8.684-502.0/ NPL-2	Indicator - Light Amber



8.684-400.0



8.660-864.0



8.660-865.0



8.661-949.0



8.663-601.0



8.660-743.0



8.660-085.0

Meters

GRACO#/Old Graco#	Specifications
8.684-400.0/ EAM-1	Battery Meter Volt - DC (20-30) - Rectangular
8.660-864.0/ EAM-2	Battery Meter 36 Volt - Round
8.660-865.0/ EAM-4	Voltage Meter (R.P.M.) 36 Volt - Round
8.661-949.0/ EA-83	Hour Meter (Digital)
8.664-304.0/ EA-90	Potentiometer
8.660-743.0/ ECM-3	Brush Pressure Meter 36 Volt - Rectangular
8.660-743.0/ EC-93	2 Prong Hour Meter (Analog)
8.663-601.0/ EKM-6	Ammeter, DC-0-75A, Round, 2" Diameter for 24V & 36V
8.666-603.0/ ETN-19	Gauge, Brush Pressure
8.663-502.0/ PB-49	Meter-Hour 12V Round
8.660-250.0/ ENM-1	Meter 24V



8.663-734.0



8.663-733.0



8.671-117.0

Rectifiers

GRACO#/Old Graco#	Specifications
8.663-734.0/ EA-62	M-20 Rectifier (35 Amp)y
8.663-440.0/ EN-3	Rectifier Bridge 600V 15 Amp
8.663-733.0/ EC-61	Rectifier, Square (50 Amp)
8.666-676.0/ EN-6	Rectifier 60 Amp / 600V
8.688-972.0	Rectifier

Potentiometers

GRACO#/Old Graco#	Specifications
8.663-440.0/ DSC-2	Potentiometer Only
8.671-117.0	Potentiometer 100K
8.664-304.0/ EA-90	Potentiometer 5K

Cable Ties

GRACO#/Old Graco#	Specifications
8.683-500.0/ EW-10	Cable Ties 100/PK 6"
8.664-304.0/ EW-11	Cable Ties 100/PK 8"
8.664-304.0/ EW-12	Cable Ties 100/PK 14-1/2"

NOTE: Sizes vary depending on MFG



8.683-346.0



8.666-644.0



8.663-344.0

Motor Carbon Brushes

GRACO#/Old Graco#	Specifications	Width	Thickness	Length	Lead Length
TYPE A					
9.848-036.0/ EA-77	Carbon Brushes (4/set)	5/8	3/16	1-1/16	2-3/4
8.683-344.0/ EA-2000	Carbon Brushes (4/set)	3/4	3/8	1-1/2	2-1/8
8.666-644.0/ EC-30	Motor Brush	1/2	1/4	7/8	2-1/4
8.662-332.0/ EC-44	Carbon Brush	1	11/32	1	2-13/16
8.683-441.0/ EC-51	Carbon Brush	5/8	3/16	1-1/16	2-3/4
8.663-344.0/ ENS-4	Carbon Brush	5/8	1/4	1-1/4	Spring
8.662-331.0/ F732775-1	Carbon Brush (Single)	5/8	1/4	1	2-5/8
9.848-034.0/ EA-4	4/set	7/8	3/8	1-3/16	3
9.848-434.0/ MTA-3-1	Carbon Brushes (4/set)	1	11/32	1	2-13/16
TYPE B					
9.848-035.0/ EA-75	Carbon Brushes (4/set)	1/2W	5/16	13/16	2-13/16
8.683-428.0/ EC-33	Carbon Brush	7/8	3/8	1-1/16	3
TYPE C					
8.662-333.0/ EA-76	Carbon Brushes (2/set)	7/8	5/16	1-1/16	1-1/4

* See more Motor Carbon brushes on page 99



TYPE A



TYPE B



TYPE C



TYPE D

Motor Carbon Brushes* (continued)

GRACO#/Old Graco#	Specifications	Width	Thickness	Length	Lead Length
TYPE D					
8.663-344.0/ ENS-4	Carbon Brush				
SPRINGS					
8.683-346.0/ EA-2001	Carbon Brush Spring				
9.848-042.0/ EA-2000K	EA2000 & 2001 (4/set)				
8.684-404.0/ MTA-3-2	Carbon Brush Spring (4/set)				
8.660-103.0/ F732775-2	Brush Spring				

* See more Motor Carbon brushes on page 98

Solenoids

GRACO#/Old Graco#	Specifications
8.600-637.0/ EA-80	36 Volt DC, 4 Post (2 Large and 2 Small)
8.660-649.0/ EC-43	36 Volt DC, 4 Post (2 Large and 2 Small)
8.666-676.0/ EC-81	36 Volt DC, 6 Post (4 Large and 2 Small)
8.662-076.0/ ETN-16	36 Volt DC, 6 Post (4 Large and 2 Small)
8.660-648.0/ EC-1	24 Volt DC, 4 Post (2 Large and 2 Small)
8.664-878.0/ EC-97	24 Volt DC, 6 Post (4 Large and 2 Small)
8.663-579.0	12 Volt DC, 3 Post (2 Large and 1 Push-on)
8.689-137.0	12 Volt DC, 4 Post (2 Large and 2 Small)
8.662-076.0	24 Volt DC, 4 Post (2 Large and 2 Small)
8.600-642.0	24 Volt DC, 4 Post (2 Large and 2 Small)



EC-1



EA-80



EA-82



EC-43



EC-81



ETN-16



Switches

GRACO#/Old Graco#	Specifications
8.660-663.0/ EA-3	20 Amp - 125 Volt 10 Amp - 250 Volt 1.5 HP - 125 Volt
9.848-431.0/ EA-3-H	Same as above w/ Hole in Toggle
8.661-996.0/ EA-5	Rocker Switch w/ Red Light (3 Terminal) 15 Amp - 125 Volt 10 Amp - 250 Volt 1/2 HP 125-250 Volt
8.660-959.0/ EA-8	15 Amp - 125 Volt 10 Amp - 250 Volt (2 Terminal)
8.660-934.0/ EA-11	20 Amp - 125 Volt (2 Terminal)
8.661-609.0/ EA-14	25 Amp - 125-250 Volt 1.5 HP - 125 Volt (N.C.) (2 Terminal) 2 HP - 250 Volt (N.C.)
8.661-995.0/ EA-15	12 Amp - 125 Volt (2 Terminal) 6 Amp - 250 Volt
8.661-709.0/ EA-21	1 N.O Contact 1 N.C Contact 20 Amp - 125 Volt (3 Terminal)
9.848-032.0/ EA-26	1.5 HP - 125 Volt (N.O.) 2 HP - 250 Volt (N.O.) (2 Terminal)
8.663-463.0/ EA-30	15 Amp - 125 Volt 10 Amp - 250 Volt 3/4 HP - 120-240 Volt (3 Terminal)
8.665-261.0/ EA-31	20 Amp - 125-250 Volt 1 HP - 125 Volt 2 HP - 250 Volt (3 Terminal)
8.663-462.0/ EA-32	20 Amp - 125-250 Volt (3 Terminal)
8.660-808.0/ EA-36	20 Amp - 125-250 Volt (6 Terminal)
8.661-999.0/ EA-37	20 Amp - 125-250 Volt (2 Terminal)
8.661-993.0/ EA-60	Stationary Switch - Single Contact
8.600-713.0/ EA-81	15 Amp 125-250 Vac (3 Terminal)
8.662-004.0/ EA-84	15 Amp 125-250 Vac (2 Terminal)
8.662-003.0/ EA-84	Key Switch
8.662-002.0/ EA-89	20 Amp 125-250 Volt
8.662-002.0/ EC-39	16 Amp - 125 Volt 8 Amp - 250 Volt
8.662-006.0/ EA-85	Switch 8 Amp
8.688-689.0	Switch, Rocker SPST, Paddle
8.686-073.0	Switch, Roller, 16 Amp
8.687-015.0	Switch, Snap, 10 Amp
8.689-941.0	Switch, Rocker SPST Momentary
8.805-075.0	Switch, Snap, 10 Amp Short
8.664-652.0	Key Switch
8.673-703.0	Key Only (2/set) for 8.664-652.0
8.689-940.0	Switch, Rocker SPST
8.661-266.0/ EAL-1	Key Switch
8.661-603.0/ EAL-5	20 Amp - 125 Volt
8.663-421.0/ EB-13	15 Amp - 125 Volt 10 Amp - 250 Volt (6 Terminal)
8.663-115.0/ EB-20	1 HP - 125 Volt 2 HP - 250 Volt

GRACO#/Old Graco#	Specifications
8.662-243.0/ EB-40	20 Amp 18 Volt (6 Terminal)
8.662-242.0/ EB-41	20 Amp 18 Volt (6 Terminal)
8.662-241.0/ EB-42	20 Amp 18 Volt (4 Terminal)
8.661-605.0/ ECX-1	Switch, Rocker ON/OFF 120/220V
8.663-465.0/ EN-2	Switch, Toggle, DPST
8.660-313.0/ EN-2	Switch, Toggle 2PDT On-Off-On
8.660-295.0/ EN-4	Switch, Rocker
8.660-296.0/ EN-5	Switch, Rocker Light
8.665-259.0/ ETN-1	Switch, Rocker 15 Amp - 125 Volt 10 Amp - 250 Volt
8.662-208.0/ ETN-2	3/4 HP - 250 Volt (4 Terminal) 15 Amp - 125 Volt 3/4 HP - 250 Volt (6 Terminal)
8.663-437.0/ ETN-15	10 Amp - 125 Volt
9.848-039.0/ ETN-17	1 HP - 125 Volt 2 HP - 250 Volt
8.660-808.0/ EA-36	1 N.O Contact 1 N.C Contact 20 Amp - 125 Volt (3 Terminal)
8.662-006.0/ EC-39	20 Amp - 125 Volt 1 HP - 125 Volt
8.660-783.0/ EC-64	2 HP - 250 Volt 16 Amp - 250 Volt
8.660-782.0/ EC-64	8 Amp - 250 Volt 15 Amp - 125 Volt 10 Amp - 250 Volt (4 Terminal) 15 Amp -125 Volt 10 Amp - 250 Volt (6 Terminal)
8.660-776.0/ EC-80	1/8 HP - 125 Volt 2 Amp - 125 Volt
8.660-778.0/ EC-86	10 Amp - 250 Volt 15 Amp - 125 Volt (4 Terminal)
8.660-587.0/ EC-88	10 Amp - 250 Volt 15 Amp - 125 Volt 3/4 HP - 125-250 Volt (9 Terminal) 3 pst
8.660-586.0/ EC-90	Key Switch
8.660-593.0/ EC-91	Lever Switch
8.660-574.0/ EC-92	Float Switch
8.663-459.0/ ENS-3	15 Amp - 125 Volt 10 Amp - 250 Volt (3 Terminal)
8.663-457.0/ ETN-14	15 Amp - 125-250 Volt 3/4 HP - 125 Volt 1/2 HP - 250 Volt (3 Terminal)
8.663-437.0/ ETN-15	10 Amp - 125 Volt (3 Terminal)
8.663-419.0/ EK-5	10 Amp - 125 Volt 1 HP - 125 Volt 2 HP - 250 Volt
8.660-294.0/ ENS-5	Vac Switch Rocker 2PST 2TER
8.660-239.0/ ENS-6	Master Switch Rocker 2PST 2TER
8.663-418.0/ ES-1	15 Amp - 125-250 Volt 1/2 HP - 125-250 Volt
8.663-420.0/ ES-2	10 Amp - 250 Volt 16 Amp - 125 Volt (2 Terminal)
8.662-206.0/ ETN-20	Switch

Electical Parts



Switches (con't)

GRACO#/Old Graco#	Specifications
8.660-965.0/ E-81	10 Amp - 250 Volt with Red Light 15 Amp - 125 Volt 1/2 HP - 125-250 Volt (3 Terminal)
8.665-679.0/ WV-1	Switch On/Off
8.614-325.0/ WV-2	Switch - Micro
8.661-725.0/ EM-1	30 Amp 125-250 Volt
8.666-596.0/ FTN-3	Float Switch w/plug, Tennant



Electical Parts

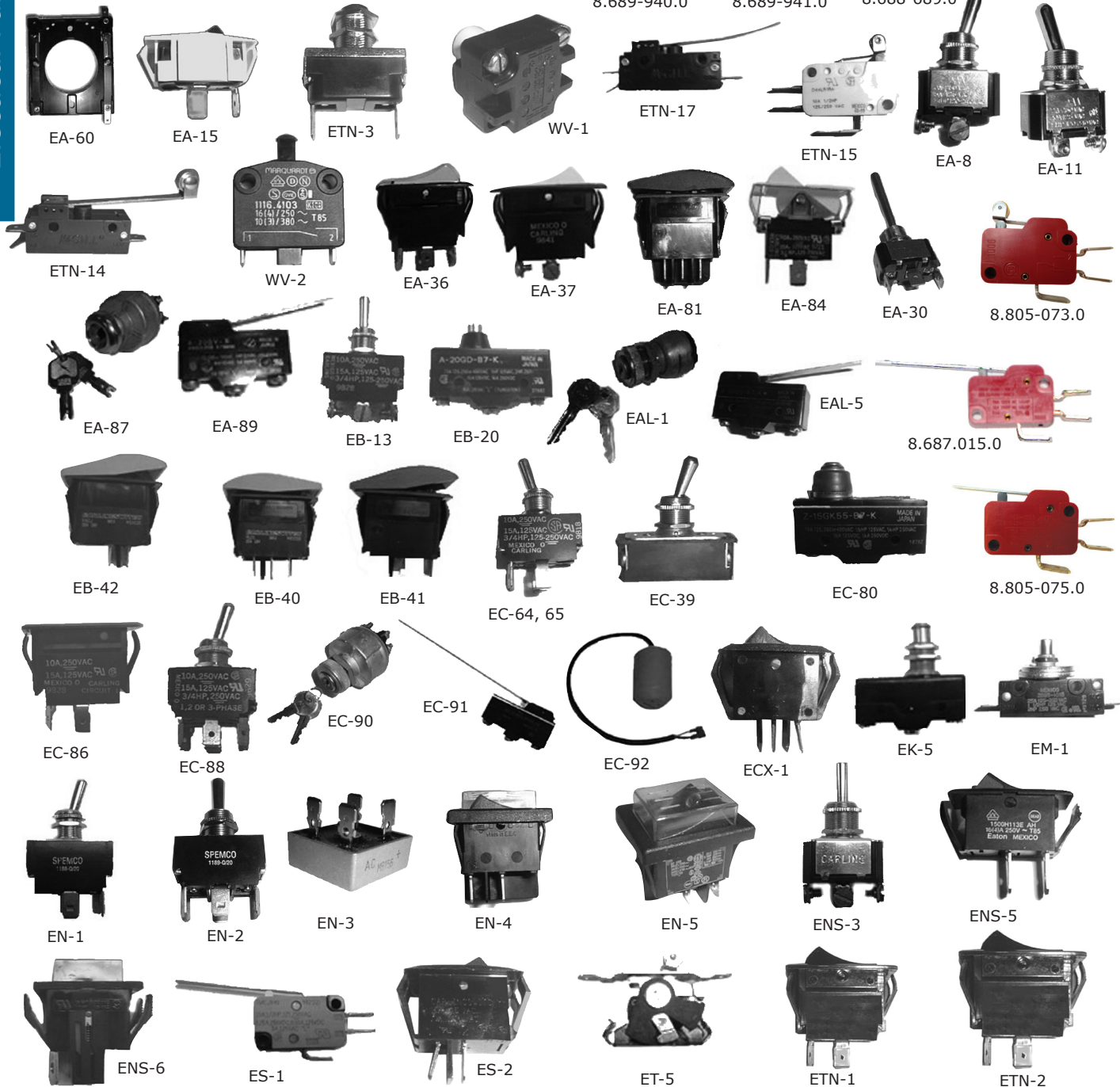



Kent

GRACO#/Old Graco#	Specifications	To Fit	OEM#
8.660-663.0/ EA-3	20 Amp - 125 Volt, 10 Amp - 250 Volt 1.5 HP - 125 Volt	Various Applications	56200336, 56200340, 130701, 02-451-9, 0224684, 2-00-01005, 3184, 380002, 5215, 8516, EK204-73, 476640, 294519
8.660-115.0/ EB-20	1 HP - 125 Volt 2 HP - 250 Volt	Buffers	12485, 13944, 26412, 6685, A-20GD-B7-K, 56026412
8.663-446.0/ EK-1	10 Amp - 250 Volt 15 Amp - 125 Volt 3/4 HP - 125-250 Volt	Auto Scrubbers	0297623, 28161052, 56026466, 026469, TILA51IL-WH-FN
8.663-419.0/ EK-5	10 Amp - 125 Volt 1 HP - 125 Volt 2 HP - 250 Volt	Auto Scrubbers	0297480, 56026515

Minuteman

GRACO#/Old Graco#	Specifications	To Fit	OEM#
8.660-663.0/ EA-3	20 Amp - 125 Volt, 10 Amp - 250 Volt 1.5 HP - 125 Volt	Various Applications	56200336, 56200340, 130701, 02-451-9, 0224684, 2-00-01005, 3184, 380002, 5215, 8516, EK204-73, 476640, 294519
8.660-604.0/ EA-14	1.5 HP - 125 Volt 2 HP - 250 Volt (2 Term)	M2200 Burnisher	56376435, 56388019, 376435, 130729, 740129, 388019, 2653-0027, 171225, 1301220, 0238835
8.661-709.0/ EA-21	1 N.O Contact 1 N.C Contact 20 Amp - 125 Volt (3 Term)	M3200	0297644, 2-00-04439, 2601-1150, 327450, 56321281, 730932, 830932, 911562
8.663-462.0/ EA-32	20 Amp - 125-250 Volt (3 Term)	Buffers	0297675, 2609-1150, 740029, 740029, 72015
8.660-808.0/ EA-36	20 Amp - 125-250 Volt (3 Term)	200 w/Drive	0225581, 56377003, 47381A, TIGL01-6S-WH-NB, 740801, 47381B
8.660-587.0/ EC-88	10 Amp - 250 Volt 15 Amp - 125 Volt 3/4 HP - 125-250 Volt (9 Term)	260, 265, 320	47384A, HM251-73, 47384C, 47384B, 827060
8.665-259.0/ ETN-1	15 Amp - 125-250 Volt (9 Term) 15 Amp - 125 Volt 10 Amp - 250 Volt 3/4 HP - 250 Volt (4 Term)	Auto Scrubbers	039-705-012, 039-705-081, 1301218, 740107, TIGK51-6S-BL-NB, 19417, 039705012, 809754, 039705081

Nilfisk/Advance

GRACO#/Old Graco#	Specifications	To Fit	OEM#
8.660-663.0/ EA-3	20 Amp - 125 Volt, 10 Amp - 250 Volt 1.5 HP - 125 Volt	Various Applications	56200336, 56200340, 130701, 02-451-9, 0224684, 2-00-01005, 3184, 380002, 5215, 8516, EK204-73, 476640, 294519, 56157562
9.848-431.0/ EA-3-H	Same as above w/Hole in Toggle	Advance	56157562
8.661-996.0/ EA-5	SP Rocker Switch w/ Red Light (3 Term) 15 Amp - 125 Volt 10 Amp - 250 Volt 1/2 HP 125-250 Volt	Convertamatics	0247717, 130647, 356079, 365079, LTILA54-1L-BL-R
8.660-659.0/ EA-8	15 Amp - 125 Volt 10 Amp - 250 Volt (2 Term)	Convertamatics	0224668, 2-00-03499, 2FA-54-73, 56370347, 44-110-1, 47320A, 911287, 911388, 911961, B100182, 90599, 4491101
8.660-934.0/ EA-11	20 Amp - 125 Volt (2 Term)	Convertamatics	0228758, 2FAA04-73, F741136
8.661-609.0/ EA-14	25 Amp - 125-250 Volt 1.5 HP - 125 Volt (N.C.) (2 Term) 2 HP - 250 Volt (N.C.)	Matador, Whirlamatic 1000, 285LX, 325LX, 385LX, Carpetriever & Pacemaker	56026603, 56327450
8.661-995.0/ EA-15	12 Amp - 125 Volt (2 Term) 6 Amp - 250 Volt	Carpetwins 14, 16, 20	0247716, 56325140, 912172, 0805-1213



Nilfisk/Advance (con't)

GRACO#/Old Graco#	Specifications	To Fit	OEM#
8.660-663.0/ EA-21	1 N.O Contact 1 N.C Contact 20 Amp - 125 Volt (3 Term)	Carpetwin, 320HS	0297644, 2-00-04439, 2601-1150, 327450, 730932, 830932, 911562, 56321281
8.848-032.0/ EA-26	1.5 HP - 125 Volt (N.O.) 2 HP - 250 Volt (N.O.) (2 Terminal)	Same As EA-14 (Normally Open Switch)	56385615, 0247712, 385614
8.663-463.0/ EA-30	15 Amp - 125 Volt 10 Amp - 250 Volt 3/4 HP - 120-240 Volt (3 Terminal)	Carpetrons	56217859, 6FC57-EC-TABS
8.665-261.0/ EA-31	20 Amp - 125-250 Volt 1 HP - 125 Volt 2 HP - 250 Volt (3 Terminal)	Carpetwins & Pressure Washers	0297675, 2609-1150, 740029, 44847, 2603-1150, 13197
8.663-462.0/ EA-32	20 Amp - 125-250 Volt (3 Terminal)	Hurricane 600 w/ Pressure Switch	0297675, 2609-1150, 740029, 740029, 72015
8.660-808.0/ EA-36	20 Amp - 125-250 Volt (6 Terminal)	Trac Series, 285LX, 325LX, 385LX	0225581, 56377003, 740801
8.661-999.0/ EA-37	20 Amp - 125-250 Volt (2 Terminal)	Trac Series, 285LX, 325LX, 385LX	130677, 56376348
8.661-993.0/ EA-60	Stationary Switch Single Contact	17, 17-S, M-20, M-20-S	448507-4, 171228, S-5400
8.660-713.0/ EA-81	15 Amp 125-250 Vac (3 Term)	Convertamatics	56393312
8.662-004.0/ EA-84	15 Amp 125-250 Vac (2 Term)	Convertamatics	56324272
8.662-002.0/ EA-89	20 Amp 125-250 Volt	Convertamatics	56324362
8.662-006.0/ EC-39	16 Amp - 125 Volt 8 Amp - 250 Volt	Convertamatics	56207071, F741138, DK284-73, 912204, 911456, 911249, 741138, 207075, 0224680
8.672-034.0/ EA-93	Fuse - 150 AMP	Most Advance Nilfisk Machines	56412089 207075, 0224680

NSS

GRACO#/Old Graco#	Specifications	To Fit	OEM#
8.660-663.0/ EA-3	20 Amp - 125 Volt 10 Amp - 250 Volt 1.5 HP - 125 Volt	Various Applications	56200336, 56200340, 130701, 02-451-9, 0224684, 2-00-01005, 3184, 380002, 5215, 8516, EK204-73, 476640, 0294519
8.660-659.0/ EA-8	15 Amp - 125 Volt 10 Amp - 250 Volt (2 Terminal)	Wrangler	0224668, 2-00-03499, 2FA-54-73, 44-110-1, 47320A, 911287, 911388, 911961, B100182, 90599, 4491101
8.660-783.0/ EC-64	15 Amp - 125 Volt 10 Amp - 250 Volt (4 Terminal)	Wrangler	0225184, 27-204-1, 2GK51-73, 912302, 2792041
8.663-459.0/ ENS-3	10 Amp - 250 Volt 15 Amp - 125 Volt 3/4 HP - 240 Volt (3 Terminal)	Wrangler 27	0297663, 27-205-1, 2FC-54-73, 2792051
8.660-294.0/ ENS-5	Vac Switch	Wrangler 27 F/B, 33 F/B	48-075-1, 4890751
ENS-6	Master Switch	Wrangler 27 F/B, 33 F/B	26-069-1, 2690691



Pullman-Holt

GRACO#/Old Graco#	Specifications	To Fit	OEM#
8.660-663.0/ EA-3	20 Amp - 125 Volt, 10 Amp - 250 Volt 1.5 HP - 125 Volt	Vacs	56200336, 56200340, 130701, 02-451-9, 0224684, 2-00-01005, 3184, 380002, 5215, 8516, EK204-73, 476640, 294519
8.660-115.0/ EB-20	1 HP - 125 Volt 2 HP - 250 Volt	Buffers	12485, 13944, 56026412, 6685, A-20GD-B7-K
8.662-006.0/ EC-39	16 Amp - 125 Volt 8 Amp - 250 Volt	Vacs	0224680, 56207071, 207075, 741138, 911249, 911456, 912204, DK284-73, F741138

Steamex

GRACO#/Old Graco#	Specifications	To Fit	OEM#
8.663-418.0/ ES-1	15 Amp - 125-250 Volt 1/2 HP - 125-250 Volt	Triumph 870, 1190, MX21	3703
8.663-420.0/ ES-2	10 Amp - 250 Volt 16 Amp - 125 Volt (2 Terminal)	Triumph 870, 1190, MX21	0297482, 911089, S519P

Tennant

GRACO#/Old Graco#	Specifications	To Fit	OEM#
8.665-261.0/ EA-31	20 Amp - 125-250 Volt 1 HP - 125 Volt 2 HP - 250 Volt	5700	13197, 2603-1150, 26603, 44847, 56026603, 5628657
8.662-206.0 / ETN-20	Switch	5700	222116
8.686-073.0	16 AMP, Lever w/Roller	T2, T3, T5, 1510, 1530, 1610, STRIVE	611005
8.687-015.0	10 AMP, SNAP, LEVER	T3	1011208
8.805-075.0	10 AMP, Snap, Short Lever	A5, SS 17-20-24, T3, T5	1012568
8.689-941.0	SPST Rocker, Momentary	5680, 5700, T3,T5, T7, T15, SS 17-32"	1044393
8.688-689.0	SPST Rocker, Paddle	T7, SSR, R14, STRIVE	1013763
8.664-652.0	SWITCH, KEY	SS 17-32", SSR, T2, T3, T5, T7, S8	1011402

Windsor

GRACO#/Old Graco#	Specifications	To Fit	OEM#
8.660-965.0/ E-81	10 Amp - 250 Volt with Red Light 15 Amp - 125 Volt 1/2 HP - 125-250 Volt (3 Terminal)	Windsor Dominators	0229395, 72008, 72004
8.665-679.0/ WV-1	Switch On/Off	Versamatic	0517, 1957ER
8.614-325.0/ WV-2	Switch - Micro	Versamatic	0504, 0506, 0582



8.683-507.0



8.683-521.0



8.683-527.0



8.683-531.0



8.683-531.0

Terminals

GRACO#/Old Graco#	Specifications	Wire Size	Insulation	Stud Size
8.683-507.0 / EW-17	Terminal 100/pk	22-18	Red	#10
8.683-508.0 / EW-18	Terminal 100/pk	16-14	Blue	#8
8.683-509.0 / EW-19	Terminal 100/pk	16-14	Blue	#10
8.683-510.0 / EW-20	Terminal 100/pk	16-14	Blue	1/4"
8.683-514.0 / EW-21	Terminal 100/pk	16-14	Blue	5/16"
8.683-515.0 / EW-22	Terminal 100/pk	16-14	Blue	3/8"
8.683-516.0 / EW-23	Terminal 100/pk	12-10	Yellow	#10
8.683-517.0 / EW-24	Terminal - Yellow - 100/pk	12-10	Yellow	1/4"
8.683-518.0 / EW-25	Insulated Terminal 100/pk	12-10	Yellow	5/16"
8.683-519.0 / EW-26	Terminal - Yellow - 100/pk	12-10	Yellow	3/8"
8.683-520.0 / EW-27	Terminal 100/pk - Spade Terminal Type	16-14	Blue	
8.683-521.0 / EW-28	Terminal 100/pk - Push-On Male Termonal Type	16-14	Blue	
EW-30	Non Insulated Terminal - 100/pk	22-18		#10
EW-31	Non Insulated Terminal - 100/pk	16-14		#8
8.683-528.0 / EW-33	Non Insulated Terminal - 100/pk	16-14		#10
8.683-529.0 / EW-34	Non Insulated Terminal - 100/pk	12-10		3/8"
8.683-530.0 / EW-35	Non Insulated Terminal - 100/pk	12-10		3/8"
8.683-531.0 / EW-36	Terminal, Push-on Female, Non Insulated - Push-On Female Terminal Type	12-10		
8.683-532.0 / EW-37	Non Insulated Terminal 100/pk Push-On Female Terminal Type	22-28		
8.683-536.0 / EW-40	Terminal 100/pk - Connector Terminal Type	16-14	Red	
8.683-537.0 / EW-41	Terminal Connector 100/pk - Connector Terminal Type	12-10	Blue	
8.683-538.0 / EW-42	Terminal Connector 100/pk - Connector Terminal Type	16-14	Yellow	
8.683-539.0 / EW-44	Terminal Kit			



8.644-505.0

Wing Nuts

GRACO#/Old Graco#	Specifications	Color
8.683-503.0 / EW-13	100/pk - 22-16 GA	Gray
8.664-504.0 / EW-14	100/pk - 22-16 GA	Blue
8.664-505.0 / EW-15	100/pk - 22-14 GA	Orange
8.664-506.0 / EW-16	100/pk - 18-10 GA	Yellow



Graco Legacy Air Mover - LAM³



GRACO#
1.004-014.0

3 Speed Air Mover

Features

- 3 speeds of air movement for every type of job.
- A maximum air movement of 3,000 cfm for rapid drying of carpet and hard floors.
- Sturdy, four point motor mount to withstand heavy use and rough handling.
- Built in carpet clip for flood restoration jobs.

Equipment

GRACO specifications

- Rotationally molded polyethylene construction with molded offset handle and cord wrap
- 0.5 hp (373 watts) motor with continuous duty, capacitor start, thermally protected with four-point mount
- 9.6" dia x 9.1" wide fan wheel
- Fan speeds ranging from 1050 rpm - 1600 rpm
- Color: Gray
- Airflow from 2000 cfm - 3000 cfm
- 25 ft power cable with 16/3 SJTW and three-wire molded plug
- 120 volt AC, 60 HZ
- 20" long, 16" wide, 18.8" high, and 33.5 lbs
- **Purchase 20 or more LAM³ Air Movers and we will personalize the air movers with your logo and information**

Filters/Stainers/Floats



Breuer-Tornado

GRACO#/Old Graco#	OEM	Description
8.600-351.0/ FA-1	13104	Vacuum Filter
8.683-923.0/ FB-1	3008	Vacuum Filter



8.600-351.0



8.660-644.0



8.661-990.0

Nilfisk/Advance/Clarke

GRACO#/Old Graco#	OEM	Description
8.600-351.0/ FA-1	56384898	Vacuum Filter
8.660-644.0/ FA-4	56380922	Vacuum Filter
FA-5	56323065	Filter Exhaust
FA-6	56380918	Vacuum Filter
8.683-921.0/ FA-8	56331070	Vacuum Filter
FA-9	56330573	Vacuum Filter
8.661-920.0/ FA-10	56180032	Vacuum Filter
8.683-911.0/ FA-11	56323158	Filter, Internal
8.683-915.0/ FA-20	56325163	Vacuum Filter
8.683-920.0/ FA-61	56209461	Vacuum Filter
8.661-990.0/ FA-3	56389125	Strainer
8.666-092.0	56412173	Solution Filter
8.660-658.0/ FC-2	878535	Strainer
8.660-549.0/ FC-63	56476A	Strainer, Vacuum



8.660-619.0



8.660-705.0

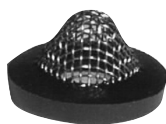

8.665-253.0

Clarke

GRACO#/Old Graco#	OEM	Description
8.600-351.0/ FA-1	623382	Vacuum Filter
8.660-619.0/ FC-1	703301	Vacuum Filter
8.660-644.0/ FC-4	628520	Vacuum Motor Screen
8.660-705.0/ FC-6	833301	Float Assy.
FC-15	635901	Vacuum Filter
8.683-965.0/ FC-15-S	638522	Vacuum Motor Screen
8.683-967.0/ FC-25	623320	Vacuum Filter
8.683-968.0/ FC-35	673312	Vacuum Filter
8.660-702.0/ FC-60	833308	Vacuum Filter
FC-61	838516 67306A	Vacuum Filter
8.665-253.0/ FC-62	838517	Filter Washer
8.660-539.0/ FC-64	58069A	Screen Vac Filter Encore

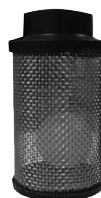

8.660-213.0

NSS

GRACO#/Old Graco#	OEM	Description
8.600-351.0/ FA-1	09-048-1	Vacuum Filter
8.660-230.0/ N-L-1	26-9-091-1	Lid, Center Only
8.683-992.0/ FNS-2	68-9-016-1	Safety Filter
8.660-213.0/ FNS-1	23-9-154-1	Float Screen Assy
8.671-011.0/ NSS-F1	26-9-109-1	Filter Muffler, Black Foam

Eureka

GRACO#/Old Graco#	OEM	Description
FE-2	61805	Hepa Filter DCF2 Dust Cup
8.683-978.0/ FE-3	61825	Hepa Filter DCF3 Dust Cup
8.683-979.0/ FE-4	60285	Hepa Filter

Kent

GRACO#/Old Graco#	OEM	Description
8.600-351.0/ FA-1	46817	Vacuum Filter

Minuteman

GRACO#/Old Graco#	OEM	Description
8.664-951.0/ R-HK-1	380064	Foam Ring

Pro-Team

GRACO#/Old Graco#	OEM	Description
8.619-887.0/ FPT-1F	100343, 101949	Domed filter, foam insert only
8.664-775.0/ FPT-1	102784, 100030	Domed filter, complete w/foam insert



Filters/Stainers/Floats & Gaskets



8.619-984.0



8.683-989.0

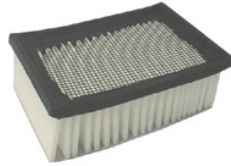

8.666-594.0



8.614-160.0



8.687-484.0

Tennant/Nobles/Castex

GRACO#/Old Graco#	OEM	Description
8.619-984.0/ FNB-1	180613	Float-Shutoff
8.683-989.0/ FNB-2	102550	Foam Filter
8.660-309.0/ FNB-3	230794	Screen
8.660-658.0/ FC-2	069-760-038	Strainer
8.683-996.0/ FTN-1	067-760-688	Vacuum Filter
8.665-261.0/ FTN-2	067-760-787	Vacuum Filter
8.660-230.0/ N-L-1	100105	Lid, Center Only
8.678-582.0	1037822	Filter, Panel 2" x 6.9" x 7.6"
8.666-594.0/ FTN-4	1037821 370113	Filter, Vac

Windsor

GRACO#/Old Graco#	OEM	Description
8.685-645.0/ WV-5	1043	Filter- Exhaust
WV-6	1044	Filter- Vacuum
8.614-160.0/ WV-22	1534	Filter - Exhaust
8.687-484.0/ WV-23	5301ER	Filter - Micro
8.614-343.0/ WV-24	1825	Filter - Motor
8.614-137.0/ WV-25	1878	Filter - Exhaust

Shop Supplies

Gaskets

American-Lincoln

GRACO#/Old Graco#	OEM	Description
8.680-581.0/ AL-G-1	7-29-00015	Cleanout Door Gasket
8.680-586.0/ AL-G-3	2-22-00013 7-29-00042	Float Gasket
8.680-588.0/ AL-G-6	2-22-01895	Gasket (1/4 x 7/8 x 51)
8.680-591.0/ AL-G-9	7-29-00016	Cleanout Flange Gasket

GRACO#/Old Graco#	OEM	Description
8.680-582.0/ AL-G-10	7-29-00109	Gasket (3/8 x 1 x 20)
8.680-583.0/ AL-G-11	7-29-00103	Gasket (3/8 x 1 x 50)
8.680-584.0/ AL-G-12	7-29-00110	Gasket (3/8 x 1 x 19)
AL-G-13	7-29-00111	Gasket (1/2 x 3 x 16-1/2)

Aztec

GRACO#/Old Graco#	OEM	Description
8.805-427.0	237-500HG	Gasket, Guzzler

Gaskets



8.6682-795.0

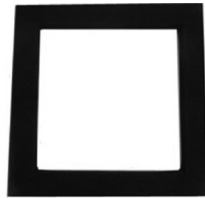

8.682-796.0

Breuer-Tornado

GRACO#/Old Graco#	OEM	Description
8.662-231.0 / B-G-11	13095	Gasket (1/8 x 1/2 x 6)
8.682-796.0 / B-G-5	17646	Gasket Cleanout Door
8.682-797.0 / B-G-7	17647	Gasket Backing Plate
8.680-793.0 / B-G-2	3398	Gasket (1/2 x 3-1/2 x 4-1/2)
B-G-3	3387	"O" Ring
8.662-230.0 / B-G-1	3492	Drain Door Gaskets
8.682-795.0 / B-G-4	3821	Gasket (1/2 x 3 x 4)



8.660-706.0

Clarke

GRACO#/Old Graco#	OEM	Description
8.660-710.0 / C-G-80	34220B	Vac Chamber Gasket
8.660-550.0 / C-G-64	34260B	Squeegee Gasket
9.848-019.0 / C-G-65	34265A	Recovery Lid Gasket
9.848-219.0 / C-G-66	34266A	Solution Lid Gasket
8.662-231.0 / C-G-7	463411	Cleanout Cover Gasket
FB2496	643418	Gasket - Vacuum Motor
8.683-184.0 / C-G-33	733441	Cover Gasket
8.683-186.0 / C-G-5	800552	Side Apron
8.660-707.0 / C-G-60	833402	Filter Gasket
8.660-708.0 / C-G-61	833403	Gasket-Vac Chamber (Round)
8.660-624.0 / C-G-1	873403	Float Gasket
8.660-706.0 / C-G-63	833407	Gasket-Drain Valve
8.660-625.0 / C-G-4	883408	Cleanout Flange Gasket
8.660-622.0 / C-G-3	883410	Cleanout Door Gasket
8.660-627.0 / C-G-2	893401	Float Cage Gasket
8.682-797.0 / C-G-6	893404	Solution Valve Gasket
8.660-626.0 / C-G-8	893454	Cleanout Cover Gasket

Minuteman

GRACO#/Old Graco#	OEM	Description
8.660-706.0 / HK-G-1	809782	Gasket Cleanout Door

Nilfisk/Advance

GRACO#/Old Graco#	OEM	Description
8.680-456.0 / AD-G-15	56200298	Gasket (5/8 Round x 5 x 5-5/8)
8.680-471.0 / AD-G-4	56200395	Motor Gasket (5 x 4-3/8)
8.680-479.0 / AD-G-6	56200573	Upper Gasket Mount (2-3/4 x 3/4)
8.680-462.0 / AD-G-20	56200921	Gasket (1/4 x 7/8 x 24)
AD-G-3	56204161	Motor Gasket (3/16 x 4 x 2-5/8)
8.661-925.0 / AD-G-9	56209325	Motor Gasket (1/8 x 5-1/4 x 4-1/4)
8.680-453.0 / AD-G-12	56360384	Tank Gasket (1/4 x 7/8 x 40)
8.661-924.0 / AD-G-98	56375335	Vac Motor Gasket (Single Motor)
8.680-457.0 / AD-G-16	56375358	Gasket (3/8 x 4-1/2 x 5-1/8)
AD-G-19	56378771	Gasket (1-1/16 x 1/2 x 30-1/2)
8.680-458.0 / AD-G-17	56380763	Gasket (2-7/8 x 2-3/8 x 1-1/2)
8.600-376.0 / AD-G-5	56380905	Gasket (3/8 x 5-1/4 x 4-1/4)
8.680-486.0 / AD-G-7	56382795	Tank Gasket (3/8 x 2-3/4 x 2-1/2)
8.661-921.0 / AD-G-8	56385055	Tank Gasket (3/8 x 2-3/4 x 2-1/2)
8.661-922.0 / AD-G-11	56385245	Tank Gasket (1/4 x 1/2 x 40)
AD-G-14	56385247	Gasket (1/8 x 1/2 x 20)
8.661-927.0 / AD-G-10	56385437	Motor Gasket (1/4 x 6-1/4 x 4-1/4)
AD-G-97	56395280	Vac Motor Gasket (Double Motor)
8.806-154.0	56397151	Gasket, VAC Lid
Available per ft - 8.688-775.0		
8.661-926.0 / AD-G-96	56400613	Gasket Squeegee Tool
AD-G-99	56400614	Gasket, Squeegee Weldment
8.680-477.0 / AD-G-55	56474688	Gasket (1/4 x 1/2 x 82)
8.800-784.0	9096918000	Gasket, VAC Motor
8.806-704.0	9097555000	Gasket, VAC Motor



8.823-788.0

Factory Cat

GRACO#/Old Graco#	OEM	Description
8.623-788.0/ FB2496	5-708A	Gasket
9.848-679.0	5-708,	Gasket (set /2)

NSS

GRACO#/Old Graco#	OEM	Description
8.661-925.0/ AD-G-9	46-010-1	Tune Adapter Gasket
8.660-230.0/ N-L-1	26-091-1	Lid, Center Only
8.660-233.0/ NSS-G-1	27-162-1	Gasket Air Plate
8.660-234T.0/ NSS-G-2	27-164-1	Vac Exhaust Gasket

Pro-Team

GRACO#/Old Graco#	OEM	Description
8.660-217.0/ N-G-2	100151	Gasket Float
8.660-220.0/ N-G-3	101714	Waste Air Chamber Gasket

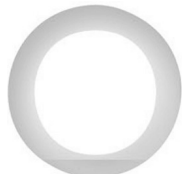

8.685-074.0

Steamex

GRACO#/Old Graco#	OEM	Description
8.685-074.0/ S-G-1	S446P	Vac Motor Gasket
8.685-075.0/ S-G-2	S446P1	Vac Motor Gasket
8.667-433.0/ S-G-3	S446P2	Vac Motor Gasket



8.662-134.0



8.685-248.0

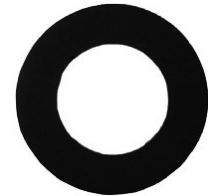

8.680-387.0

Tennant/Castex/Nobles

GRACO#/Old Graco#	OEM	Description
8.660-233.0/ CX-G-1	100117	Gasket, Exhaust-Round
8.660-261.0/ CX-G-2	100118	Gasket, Vac Motor
8.665-851.0/ CX-G-3	100042	Gasket, Recover Dome
8.683-288.0/ CX-G-4	100122	Gasket, Vac Motor
8.600-398.0/ N-G-4	603260	Squeegee Curved Gasket
8.660-230.0/ N-L-1	100105	Lid, Center Only
8.685-240.0/ TN-G-1	069-760-242	Gasket Adaptor
8.671-746.0/ TN-G-2	069-760-241	Gasket Foam
TN-G-3	069-762-237	Shim - Vac Motor
TN-G-4	069-764-071	Seal
8.662-134.0/ TN-G-5	222120	Gasket 5.25"OD X 3"ID X 1/4"
8.600-387.0/ TN-G-6	222128	Seal Vac Motor 5.7
8.660-229.0/ TN-G-7	100038	Gasket, Vac Motor
8.685-248.0/ TN-G-8	222121	Gasket, Tank Rear
8.805-881.0	86812	Gasket, Squeegee

Bulk Strip Gasket w/ Adhesive

GRACO#	Description
AG-1-B	1/4" Thickness x 7/8" Width x 50' Length
AG-3-B	1/4" Thickness x 1/2" Width x 50' Length

Vacuum Hose Cuffs & Connectors



8.660-959.0



8.660-955.0



8.660-957.0



8.660-956.0



8.660-958.0



8.684-098.0



8.660-978.0



8.660-877.0



8.672-065.0



8.684-093.0



8.600-558.0

GRACO#/Old Graco#	Size/Description	Color
8.660-959.0/ HC-1	1-1/4" Hose & 1-1/4" Wand	White
8.660-955.0/ HC-2	1-1/2" Hose & 1-1/2" Wand	White (for standard vac. hose)
8.660-957.0/ HC-2-S	1-1/2" Hose & 1-1/2" Wand	Gray Swivel Hose Cuff
8.660-956.0/ HC-3	2" Hose & 2" Wand	Gray
8.660-958.0/ HC-4	1-1/2" Hose & 1-3/4" Wand	Gray
8.684-098.0/ HC-5	2" Hose & 1-1/2" Wand	Gray
8.660-978.0/ HC-7	1-1/2" Hose & 1-1/2" Wand	White (wire hose only)
8.600-301.0/ HC-7B	1-2" Hose & 1-1/2" Wand	Black (wire hose only)
8.660-977.0/ HC-10	2" Hose Connector	Gray
8.684-091.0/ HC-11	Hose Cuff 1"	Black
8.672-065.0/ HC-15	1-1/2" Hose Connector	Gray
8.684-093.0/ HC-16	Hose Cuff 1-1/2"	Gray (screw-on)
8.684-905.0/ PW-1	1/8" Quick Disconnect (Female)	
8.684-906.0/ PW-2	1/8" Quick Disconnect (Male)	
8.600-245.0/ PW-3	1/4" Quick Disconnect (Female) with Positive Shut Off	
8.600-558.0/ PW-4	1/4" Quick Disconnect (Male) with Positive Shut Off	
8.619-750.0/ PW-5	Barb, 1/4" Brass Hose	
8.623-309.0/ PW-6	Clamp, hose 1/4" - 1/2"	
8.685-673.0/ HC-17	Hose Cuff, 1-1/2 Wire Hose - 2" Wand (Wire Hose Only)	Gray
8.685-674.0/ HC-18	Hose Cuff, 1-1/2 Wire Hose - 1-3/4" Wand (Wire Hose Only)	Black
8.805-396.0	Hose Cuff, 1-1/2 Wire Hose - 1-1/4" Wand (Wire Hose Only)	



Hoses / Specialty Hoses

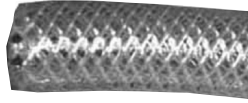

8.685-378.0



8.663-422.0

Nylon Braided

GRACO#/Old Graco#	Size	Description
8.685-378.0/ VHC-200	1/4" x 100'	Clear
8.663-422.0/ VHC-300	3/8" x 100'	Clear

Low Pressure

GRACO#/Old Graco#	Size	Description
9.848-212.0/ SH-LP25	1/4" X 25'	Blue w/ Male pipe ends 100 psi
9.848-213.0/ SH-LP50	1/4" X 50'	Blue w/ Male pipe ends 100 psi

Steam Extraction

GRACO#/Old Graco#	Size	Color
8.684-283.0/ M675-50G	2" x 50"	Gray
9.848-212.0/ SH-LP25	1/4" X 25'	Blue w/Male pipe ends 100 psi
9.848-213.0/ SH-LP50	1/4" X 50'	Blue w/Male pipe ends 100 psi

Bulk Vacuum Hoses Heavy Duty

GRACO#/Old Graco#	Size	Color
9.848-323.0/ H025-10G	1-1/2" x 10'	Gray
9.848-329.0/ H025-10GS	1-1/2" x 10'	Gray
9.848-443.0/ H025-10R	1-1/2" x 10'	Red
9.848-441.0/ H025-10RS	1-1/2" x 10'	Red
9.848-331.0/ H025-15G	1-1/2" x 15'	Gray
9.848-071.0/ H025-15GS	1-1/2" x 15'	Gray
9.848-432.0/ H025-15R	1-1/2" x 15'	Red
8.684-085.0/ H025-50G	1-1/2" x 50'	Gray
8.684-086.0/ H025-50R	1-1/2" x 50'	Red
8.684-088.0/ H075-50G	2" x 50'	Gray

All 10 ft and 15 ft Hoses Are Shipped With White Cuffs and Are Individually Boxed. (S) Indicates One Swivel Cuff and One Standard Cuff.

Bulk Vacuum Hoses Medium Duty

GRACO#/Old Graco#	Size	Color
8.684-232.0/ M100-50B	1" X 50'	Black
9.848-324.0/ M125-10G	1-1/2" x 10'	Gray
9.848-075.0/ M125-10GS	1-1/2" x 10'	Gray
9.848-425.0/ M125-15G	1-1/2" x 15'	Gray
9.848-076.0/ M125-15GS	1-1/2" x 15'	Gray
8.684-248.0/ M125-50G	1-1/2" x 50'	Gray
9.848-078.0/ M130-10R	1-1/2" x 10'	Red
9.848-077.0/ 130-10RS	1-1/2" x 10'	Red
9.848-448.0/ M130-15R	1-1/2" x 15'	Red
8.684-253.0/ M130-50R	1-1/2" x 50'	Red
9.848-438.0/ M200-10G	1-1/4" x 10'	Gray
9.848-437.0/ M200-15G	1-1/4" X 15'	Gray
8.684-257.0/ M200-50G	1-1/4" X 50'	Gray

Wire Reinforced

GRACO#/Old Graco#	Size	Color
8.685-523.0/ W354-50	1-1/2" X 50'	Clear
8.685-525.0/ W354-50G	1-1/2" X 50'	Gray
8.685-526.0/ W354-50W	1-1/2" X 50'	White
8.685-524.0/ W354-50B	1-1/2" X 50'	Black

Specialty Hoses

Breuer-Tornado

GRACO#/Old Graco#	OEM	Description
8.684-110.0/ VHB-1	13493	Vac Hose Assembly
8.685-374.0/ VHB-2	3883	Hose
6.391-171.0	63911710	Suction Hose

Hoses



Clarke

GRACO#/Old Graco#	OEM	Description
VHC-1	884112-4	Vac Hose Assembly 1-1/2" x 9"
VHC-2	874160-5	Vac Hose Assembly 1-1/2" x 10"
9.848-111.0/ VHC-3	884106-6	Vac Hose Assembly 1-1/2" x 10" 1 Cuff
VHC-4	814180-6	Pick Up Hose
VHC-32	744103-3	1-1/2" x 4' Hose w/Cuffs
8.685-382.0/ VHC-33	734145-6	Vac Hose 1-1/2 x 6"
VHC-35	734144-9	Vac Hose 1-1/2 x 12"
VHC-40	7-33-02231	Squeegee Hose 2" x 18-3/4" 1 Cuff
9.848-084.0/ VHC-60	834108-3 834121-6	Vac Hose 1-1/2" x 31" 2 Cuffs
8.685-390.0/ VHC-62	834103-4	Vac Hose 1-1/2 x 9"
8.660-722.0/ VHC-64	834102-6	Hose (Solution)
VHC-65	35122A-7 834101-8	Hose (PVC) 5/8 x 7/8"x36"
VHC-66	834107-5	Hose Split To Brush-Wire
8.660-832.0/ VHC-76	35133A-4	Hose Drain
9.848-086.0/ VHC-83	30409A	Squeegee Hose 1-1/2" x 36" (2 Cuffs)
9.848-117.0/ VHC-84	35192A	Recovery Hose
8.660-552.0/ VHC-87	30405A	Drain Hose
8.663-853.0/ VHC-88	30412A	Hose, Lower Solution
9.848-439.0	51060A	
9.848-624.0	9097069000	Hose, Lower Solution

Hoover

GRACO#/Old Graco#	OEM	Description
VHH-1	59187198	Hose Assembly - Vac

Minuteman

GRACO#/Old Graco#	OEM	Description
VHH-1	18-019	Plastic Tubing
9.848-125.0/ VHM-1	260160	Recovery Hose Assy 2603
9.848-142.0/ VHM-2	450090	Recovery Hose

Nilfisk/Advance

GRACO#/Old Graco#	OEM	Description
9.848.101/ VHA-1	56385168	Vac Hose Assembly 1-1/4" x 36"
VHA-2	56385170	Vac Hose Assembly 1-1/2" x 28" 1 Cuff
9.848-106.0/ VHA-3	56398050	Vac Hose Assembly 1-1/2" x 29" 1 Cuff
8.685-365.0/ VHA-4	56375404	Vac Hose Assembly 1-1/2" x 72"
9.848-107.0/ VHA-5	56379196	Vac Hose Assembly 1-1/2" x 32" 1 Cuff
9.848-108.0/ VHA-6	56550941	Vac Hose Assembly 1-1/2" x 31" 2 Cuffs
9.848-081.0/ VHA-7	56379202	Vac Hose Assembly 1-1/2" x 40" 2 Cuffs
8.661-947.0/ VHA-8	56404164	Vac Hose Assembly 1-1/2" x 60"
8.685-685.0/ VHA-10	56375406	Hose - Solution
VHA-11	56379188	Vac Hose Assembly 1-1/2" x 33" 1 Cuff
8.685-348.0/ VHA-13	56385164, 56374713	Drain Hose 1-1/2" x 29"
VHA-14	56386223	Vac Hose 1-1/4" x 11"
9.848-394.0/ VHA-15	56300853	Vac Hose 1-1/2" x 4" 2 Cuffs
VHA-16	56385166	Vac Hose 1-1/2" x 27"
8.685-352.0/ VHA-17	56385172	Vac Hose Assembly 1-1/2" x 31"
VHA-32	56325294	Hose (Carpetwin) 2" x 18"
VHA-33	56391747	Vac Hose Assembly 1-1/2" x 7-1/2" 2 Cuffs
8.685-359.0/ VHA-34	56372666	Vac Hose Assembly 1-1/2" x 57"
VHA-35	56377313	Vac Hose Assembly 1-1/2" x 27" 2 Cuffs
VHA-36	56377668	Vac Hose Assembly 1-1/2" x 36" 2 Cuffs
9.848-450.0	56314533	
9.848-631.0	9095583000	

NSS

GRACO#/Old Graco#	OEM	Description
9.848-087.0/ VHNS-1	27-029-9	Vac Hose 1.5" x 32"
8.685-421.0/ VHNS-2	87-113-1	Solution Feed Tube
9.848-111.0/ VHNS-3	26-059-1	Squeegee Vac Hose
9.848-425.0/ M125-15G	F215W	Gray Vac Hose 1-1/2" x 15'



Specialty Hoses/Drain Plugs/Caps

Tennant/Nobles/Castex

GRACO#/Old Graco#	OEM	Description
8.662-147.0/ VHTN-8	222370, 1011168	Vac Hose Assy.
8.688-976.0	630438	Hose, Clear Braid 3/8" x 7/8"
9.848-611.0	603547	Hose Assy. 46" Black
9.848-617.0	613759	Hose Assy. Vacuum
9.848-978.0/ VHN-1	160613	Vac Hose 1-1/2" x 30" w/Cuff
9.848-218.0/ VHN-2	160617	Vac Hose 1-1/2" x 24" w/Cuff
9.848-163.0/ VHN-3	609012	Hose 2" X 20" w/Cuff
8.685-431.0/ VHTN-5	069-760-726	Hose 1/2"
8.662-138.0/ VHTN-6	069-764-074	Hose - Drain
8.662-149.0/ VHTN-7	1011167	Hose - Drain
8.660-185.0	1010143	Hose Assy, Drain, 1.50ID x 32.3L, Blk
8.662-147.0	1011168, 222379, 374059	Hose Assy, Drain, 1.50ID 26.1L
8.662-149.0	1011167, 222788, 387517	Hose Assy, Drain, 1.50ID 27.1L Solution
8.664-663.0	1014268, 1017380, 1043538	Hose Assy, Drain, 1.50ID x 29.5L, Blk
8.689-523.0	1007072	Hose Assy, Drain, 1.50ID x 21.9L, Blk
8.805-043.0	1014274	Hose Assy, Drain 28" Molded w/2"Cuff
9.848-620.0	1015921	Hose, Vacuum 1.5"x43" 2 Cuffs Blk

Viper

GRACO#/Old Graco#	OEM	Description
9.848-674.0	VF1203A	Vac Hose



Drain Plugs

GRACO#/Old Graco#	OEM	Description
8.660-191.0/ VTN-1		Drain Plug 1-1/2"
8.600-624.0/ VA-7		Drain Plug 1-1/4"
8.662-123.0/ VTN-3		Drain Plug 1"
8.600-634.0/ VAL-4		Drain Plug 1-3/4"
8.664-648.0	1008639	Cap, Drain Assy
8.689-630.0/ DC1		Drain Cap Assy Twist-Lock 1-1/2"



Universal Hose Assembly

Graco#	Description
9.848-395.0	Hose, Drain 18" Blk w/Cap & 1.5" Cuff
9.848-396.0	Hose, Drain 18" Blk w/Cap & 1.75" Cuff
9.848-397.0	Hose, Drain 18" Blk w/Cap & 2" Cuff
9.848-398.0	Hose, Drain 18" w/Cap & 1.5" Cuff
9.848-399.0	Hose, Drain 18" w/Cap & 1.75" Cuff
9.848-400.0	Hose, Drain 18" w/Cap & 2" Cuff
9.848-401.0	Hose, Drain 24" Blk w/Cap & 1.5" Cuff
9.848-402.0	Hose, Drain 24" Blk w/Cap & 1.75" Cuff
9.848-403.0	Hose, Drain 24" Blk w/Cap & 2" Cuff
9.848-404.0	Hose, Drain 24" w/Cap & 1.5" Cuff
9.848-405.0	Hose, Drain 24" w/Cap & 1.75" Cuff
9.848-406.0	Hose, Drain 24" w/Cap & 2" Cuff
9.848-407.0	Hose, Drain 30" Blk w/Cap & 1.5" Cuff
9.848-408.0	Hose, Drain 30" Blk w/Cap & 1.75" Cuff
9.848-409.0	Hose, Drain 30" Blk w/Cap & 2" Cuff
9.848-410.0	Hose, Drain 30" w/Cap & 1.5" Cuff
9.848-411.0	Hose, Drain 30" w/Cap & 1.75" Cuff
9.848-412.0	Hose, Drain 30" W/Cap & 2" Cuff
9.848-413.0	Hose, Drain 36" Blk w/Cap & 1.5" Cuff
9.848-414.0	Hose, Drain 36" Blk w/Cap & 1.75" Cuff
9.848-415.0	Hose, Drain 36" Blk w/Cap & 2" Cuff
9.848-416.0	Hose, Drain 36" w/Cap & 1.5" Cuff
9.848-417.0	Hose, Drain 36" w/Cap & 1.75" Cuff
9.848-418.0	Hose, Drain 36" w/Cap & 2" Cuff
9.848-419.0	Hose, Drain 48" Blk w/Cap & 1.5" Cuff
9.848-420.0	Hose, Drain 48" Blk w/Cap & 1.75" Cuff
9.848-421.0	Hose, Drain 48" Blk w/Cap & 2" Cuff
9.848-422.0	Hose, Drain 54" Blk w/Cap & 1.5" Cuff
9.848-423.0	Hose, Drain 54" Blk w/Cap & 1.75" Cuff
9.848-424.0	Hose, Drain 54" Blk w/Cap & 2" Cuff



Windsor

GRACO#/Old Graco#	OEM	Description
8.614-263.0/ WV-3	1051 151614G	Hose Vacuum

Hoses

Motors - Drive/Brush



F755400, MTC-5
F755401

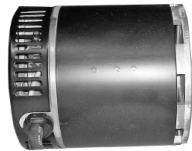

MTC-2, F732775

Clarke

GRACO#/Old Graco#	OEM	Description
8.683-868.0 / F755400	45033A	Brush Motor w/Gear Box, 200 RPM, .75 HP, 36V (Vision 32I, 26IX)
8.600-534.0 / F755400A+	53632	Brush Motor, .75 Gear, 36V, Graco A+
8.660-916.0 / F755401	45036A	Brush Motor w/Gear Box, 200 RPM, 1 HP, 36V (Encore L33, S38, L38, Vision 32IX, 38I)
8.660-636.0 / MTC-1	805254-0, 835209, 835215, 895250-9	Traverse Motor, 320 RPM, .45 HP, 36V (TB-24, TB-32, Most Leaders) Vision 21I, 32I, 32IX
8.660-634.0 / MTC-2	805263-1, 805264-9, 805266-4, 805267-2, 835201-5, 835202-3, 835208-0, 45002C	Brush Motor - Left & Right, 320 RPM, .45 HP, 36V (TB-24, Most Leaders, Vision 26I)
8.684-412.0 / MTC-5	44809A	Brush Motor w/gear box, 200 RPM, .75 HP, 24V (Vision 20B, 21I, Encore L20, Encore S20)
8.600-532.0 / MTC-5A+	53630	Brush Motor w/gear box, .75 HP, 24V



8.661-952.0

Nilfisk/Advance

GRACO#/Old Graco#	OEM	Description
8.661-952.0 / MTA-3	389420	Motor, 2000 RPM, 36V (Fits Whirlamatic 2000B after serial #284418)
8.684-407.0 / MTA-5	183575	Motor 115V, 1.5 HP 1500 RPM (Fits Whirlamatic 20 VHS)

GRACO
spotlight



8.600-532.0

Graco A+ Motors

8.600-532.0 OEM: MTC-5A+
.75 HP Gear Box 24V

8.600-534.0 OEM: F755400A+
.75 HP Gear Box 36V

9.848-635.0
.75 HP Motor / Gear Box W/Tennant Plug



8.660-903.0



8.684-412.0



8.613-858.0



MTC-1



MTN-1



MTN-2



MTN-3

Miscellaneous

GRACO#/Old Graco#	OEM	Fits	Description
8.660-914.0/ F732775	833379	Minuteman	Brush Motor 320 RPM, .75 HP, 36V
8.684-412.0/ MTC-5	740209	Minuteman	Brush Motor w/Gear Box, .75 HP, 200 RPM, 24V
8.660-634.0/ MTC-2	24228	Nilfisk/Advance/Clarke/Kent	Brush Motor 320 RPM, .45 HP, 36V
8.660-914.0/ F732775	24290	Nilfisk/Advance/Clarke/Kent	Brush Motor 320 RPM, .75 HP, 36V
8.684-410.0/ MTC-3	45002C	Nilfisk/Advance/Clarke/Kent	Brush Drive Motor
8.660-903.0/ BLC-24	54238A	Nilfisk/Advance/Clarke/Kent	Gear Box Assy
8.684-412.0/ MTC-5	56024439	Nilfisk/Advance/Clarke/Kent	Brush Drive w/Gear Box, .75 HP, 200 RPM, 24V
8.660-903.0/ BLC-24	33-118-1, 3391181	NSS	Gear Box Assy
8.660-914.0/ F732775	27-008-1, 2790081	NSS	Brush Motor 320 RPM, .75 HP, 36V
8.683-868.0/ F755400	33-077-1, 3390771	NSS	Brush Motor w/ Gear Box, 200 RPM, .75 HP, 36V
8.660-636.0/ MTC-1	27-010-1, 27-91101	NSS	Drive Motor 320 RPM, .45 HP, 36V
8.660-903.0/ BLC-24	374005	Tennant/Castex/Nobles	Gear Box Assy
8.660-916.0/ F755401	23859, 51221	Tennant/Castex/Nobles	Compressor Motor
8.660-246.0/ MTA-4	621445	Tennant/Castex/Nobles	Brush Drive Motor
8.660-634.0/ MTC-2	069-762-427	Tennant/Castex/Nobles	Brush Motor 320 RPM, .45 HP, 36V
8.660-634.0/ MTC-2	222806	Tennant/Castex/Nobles	Brush Motor 320 RPM, .45 HP, 36V
8.684-412.0/ MTC-5	130491	Tennant/Castex/Nobles	Brush Motor w/Gear Box, .75 HP, 200 RPM, 24V
8.684-414.0/ MTN-1	613422	Tennant/Castex/Nobles	Motor, Drive 1/2 HP, 1500 RPM, 24 V
8.670-196.0/ MTN-2	603398	Tennant/Castex/Nobles	Motor, 36V, 2000 RPM, 3 HP
8.684-417.0/ MTN-3	130461	Tennant/Castex/Nobles	Motor 120 Vac, 1.50 HP, 2000 RPM
8.683-868.0/ F755400	17910	Tornado	Brush Motor w/ Gear Box, 200 RPM, .75 HP, 36V
8.613-846.0/ WV-20	2241	Windsor	Brush Drive Motor 14"
8.613-858.0/ WV-21	4022	Windsor	Brush Drive Motor 18"
8.602-532.0/ MTC-5A+	53618	Windsor	Brush Motor w/Gear Box, .75 HP, 200 RPM, 24V

Motors

GRACO
spotlight

8.662-156.0



Tennant 5680 Actuator

8.662-156.0

Actuator with Motor Assembly

Replaces: Tennant 9005784, 397721, 9003318

8.806-879.0

Motor Only

Engine Parts



8.663-614.0



8.663-626.0



8.663-557.0



8.663-560.0



8.663-541.0



8.663-693.0



8.663-583.0



8.663-610.0



8.663-521.0

Briggs & Stratton

GRACO#/Old Graco#	OEM	Description
8.663-612.0/ PB-64	PH4967	Oil Filter
8.663-604.0/ PB-65	394018	Air Filter
8.663-614.0/ PB-66	372490	Die Cleaner Element
8.663-689.0/ PB-67	805049	Oil Seal
8.663-626.0/ PB-68	806039	Valve Cover Gasket
8.663-593.0/ PB-69	807986	Head Gasket
8.663-645.0/ PB-70	RC14YC	Spark Plug



8.663-455.0



8.663-453.0



8.663-445.0



8.663-959.0



8.663-650.0



8.663-650.0



8.663-628.0



8.663-955.0

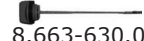

8.663-630.0

Honda

GRACO#/Old Graco#	OEM	Description
8.689-070.0/ PB-3T		Starter - Tecumseh 33329 Original
8.663-343.0/ PB-3		Starter - Tecumseh 33329 After Market
8.663-455.0/ PB-15		2" Dust Filter Band
8.663-453.0/ PB-18	12251-ZE9-900	Head Gasket, LP
8.663-650.0/ PB-19	98079-55846	Spark Plug
8.663-444.0/ PB-20	17210-ZE8-810	Air Cleaner Element
8.663-703.0/ PB-21	12391-ZE8-000	Valve Cover Gasket
8.663-445.0/ PB-22	91201-ZE3-004	Oil Seal
8.663-959.0/ PB-23	11301-ZE9-000	Oil Pan Gasket
8.663-628.0/ PB-24	15630-ZE8-000	Oil Filter Tube
8.663-955.0/ PB-25	91301-ZE9-003	O-Ring Filter Tube
8.663-673.0/ PB-26		Spud-In
8.663-710.0/ PB-28		3/8" Fuel Hose (Specify Length - Sold by the Foot)
8.663-630.0/ PB-40	298-5068	Oil Dip Stick
8.663-570.0/ PB-147	12251-ZF5-000	Head Gasket GXV390 13 HP
8.663-616.0/ PB-152	15400-POM-305PE	Oil Filter GXV390 13 HP
8.664-382.0/ PB-154	12209-ZE8-003	Valve Seals
8.663-580.0/ PB-159	30500-ZE9-L32	Ignition Coil

Kawasaki 17 HP

GRACO#/Old Graco#	OEM	Description
8.663-556.0/ PB-121	11004-7005	Head Gasket
8.663-541.0/ PB-122	11013-7001	Element - Air Filter
8.663-521.0/ PB-123	11013-7006	Air Filter
8.663-557.0/ PB-124	11038-7001	Case-Assy-Air F
8.663-560.0/ PB-125	11060-7001	Gasket, Rocket C
8.663-543.0/ PB-126	11060-7003	Carb Mtg. Gasket
8.663-561.0/ PB-127	11060-7004	Gasket-Air Filter
8.663-628.0/ PB-128	11060-7005	Intake Manifold Gasket
8.663-545.0/ PB-129	11060-7021	Gasket, Muffler
8.663-606.0/ PB-130	130B0635	Bolt-Flanged, 6X
8.663-663.0/ PB-131	13116-2057	Push Rod
8.663-553.0/ PB-134	21171-7001	Ignition Coil Assy
8.663-598.0/ PB-135	311B0600	Nut - 6MM
8.663-596.0/ PB-136	317R0800	Nut
8.663-611.0/ PB-138	49019-7001	Fuel Filter
8.663-610.0/ PB-139	49065-2078	Oil Filter
8.663-608.0/ PB-140	670D2016	O-Ring
8.663-595.0/ PB-141	92015-1170	Nut, Cap 6MM, Bla
8.663-627.0/ PB-142	92049-7001	Oil Seal
8.671-688.0/ PB-143	92049-7004	Oil Seal - PTO
8.663-544.0/ PB-148	14075-7001	Dipstick, Oil
8.663-564.0/ PB-149	59231-7001	Holder, Dipstick
8.684-698.0/ PB-150	680377	Engine, 17 HP
8.663-701.0/ PB-151	Champion RCJ8Y	Spark Plug 17 HP
8.670-484.0/ PB-150FS680610		Engine, 17 HP + Fuel System
8.663-639.0/ PB-156	21163-7010	Starter, 12V
8.663-677.0/ PB-161		Bonnet Filter (6.75" x 9" x .75")
8.663-678.0/ PB-162		Bonnet Filter for Kawasaki 17HP (3.25" x 9.5" x .625")
8.663-693.0/ PB-164	21163-7012	Starter, 120V
8.685-901.0/ PB-167	50028A	Bonnet Filter Clarke- Kawasaki



Propane Burnisher Parts

GRACO
spotlight

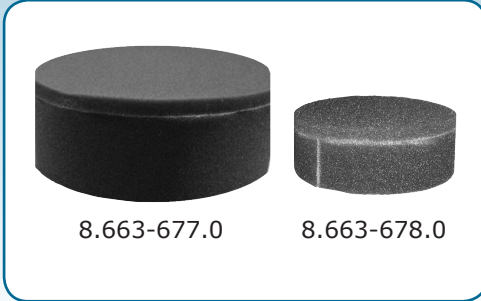

8.663-677.0

8.663-678.0

Kawasaki 17Hp Bonnet Filters

8.663-677.0 PB-161 - (6.75" X 9" X .75")
Replaces OEM# 220444

8.663-678.0 PB-162 - (3.25" X 9.5" X .625")
Replaces OEM#s 680224, 50028A,
56102562, 6191041, MP109700

Kohler

GRACO#/Old Graco#	OEM	Description
8.663-442.0/ PB-30	1204104 1204108	Head Gasket
8.661-729.0/ PB-31	1208305	Air Cleaner
8.663-605.0/ PB-32	1208308	Air Cleaner Band
8.663-652.0/ PB-33	1209807	Starter
8.663-629.0/ PB-34	5205002	Oil Filter
8.660-952.0/ PB-36	1205002	Exterior Engine Air Filter
8.663-651.0/ PB-37	1213202	Spark Plug



8.663-636.0



8.663-518.0

Onan - to Fit F248V-L 20HP

GRACO#/Old Graco#	OEM	Description
8.684-812.0/ PB-96	140-2761	Air Cleaner Knob
8.663-680.0/ PB-104	155-3282	Catalytic Muffler
8.663-551.0/ PB-105	154-2746	Exhaust Gasket
8.663-644.0/ PB-106	167-0272	Spark Plug
8.663-572.0/ PB-107	155-2429-02	Spark Arrestor
8.663-621.0/ PB-108	308-0490	Key
8.663-636.0/ PB-109	122-0645	Oil Filter
8.663-518.0/ PB-110	140-3009	Air Filter Element
8.663-686.0/ PB-111	140-2255-01	Air Filter Element Wrapper
8.663-685.0/ PB-112	140-3023	Air Intake Bonnet
8.663-568.0/ PB-114	167-1602	Ignition Leads
8.663-624.0/ PB-115	110-3181	Cylinder Head Gasket
8.664-209.0/ PB-116	110-3709	Valve Cover Gasket
8.663-522.0/ PB-117	154-2495	Intake Manifold Gasket
8.663-571.0/ PB-118	123-0954	Breather Valve
8.664-415.0/ PB-119	123-1811	Oil Fill Cap

Onan - to Fit E124V-L 14HPT

GRACO#/Old Graco#	OEM	Description
8.663-651.0/ PB-37	167-0263-02	Spark Plug
8.663-683.0/ PB-73	140-2725-01	Filter Pre-Cleaner
8.660-623.0/ PB-74	140-3111	Element Air Cleaner
8.663-618.0/ PB-75	140-2335-01	Element Wrapper
8.661-554.0/ PB-90	155-2378	Exhaust Gasket
8.663-573.0/ PB-91	155-2429-01	Spark Arrestor
8.660-676.0/ PB-92	308-0385	Exterior Engine Air Filter
8.663-692.0/ PB-93	122-0737	Oil Filter
8.661-519.0/ PB-94	140-3010	Air Filter Element
8.663-684.0/ PB-95	140-2748-01	Air Filter Element Wrapper
8.684-812.0/ PB-96	140-2761	Air Cleaner Knob
8.663-576.0/ PB-97	504-0186	Oil Drain Valve
8.661-583.0/ PB-98	167-1621	Ignition Lead
8.663-547.0/ PB-99	110-3591	Cylinder Head Gasket
8.664-769.0/ PB-100	102-1462	Valve Cover Gasket
8.684-648.0/ PB-101	123-1836	Breather Valve
8.684-649.0/ PB-102	123-1874	Oil Fill Cap

Engine Parts



Robin Engine Parts

Graco#	Oem	Description
8.689-378.0	248-35801-00	Oil filter
8.689-378.0	261-65902-A0	Replaced by 248-35801-00
8.689-393.0	263-13201-02	Replaced by 263-13201-A1
8.689-393.0	263-13201-A1	Cylinder head 1
8.689-394.0	263-13301-02	Replaced by 263-13301-A1
8.689-394.0	263-13301-A1	Cylinder head 2
8.689-395.0	263-14201-03	Valve guide
8.689-395.0	263-14211-03	Replaced by 263-14201-03
8.689-460.0	263-15021-01	Head gasket 1
8.689-461.0	263-15121-01	Head gasket 2
8.689-400.0	263-16006-03	Breather plate gasket
8.689-399.0	263-16011-A3	Main bearing cover gasket
8.677-416.0	263-16101-A3	Rocker cover gasket
8.677-800.0	263-32610-A1	Complete cleaner element
8.689-373.0	263-35201-A1	Exhaust gasket
8.677-419.0	263-35503-A3	Intake manifold gasket
8.689-375.0	263-63611-01	Oil dipstick
8.689-377.0	263-65101-A2	Oil fill tube
8.689-379.0	263-70502-A0	Starter
8.689-382.0	263-71901-01	Replaced by 263-71903-A1
8.689-382.0	263-71903-A1	Voltage regulator
8.689-381.0	263-78201-01	Ignition coil
8.689-401.0	263-79411-A1	Charge coil
8.689-373.0	270-35201-01	Replaced by 263-35201-A1
8.689-380.0	X65-01403-00	Spark plug N9YC

Belts and Pulleys (con't)

GRACO#/Old Graco#	Description	Fits
8.663-528.0/ BLE-12	Belt BX52	Many Propane Burnishers
8.663-529.0/ BLE-13	Belt BX53	Pro Buff, Pioneer, Other Popular Brands
8.671-779.0/ PB-8	Belt Tensioner Lovejoy	Pro Buff, Other Popular Brands
8.672-197.0/ PB-146	Belt B-44	A. L. Cook 24"
8.683-075.0/ BX-55	Belt-Optibelt	



8.663-664.0



8.663-613.0



8.663-447.0



8.663-688.0



8.663-563.0

Belts and Pulleys

GRACO#/Old Graco#	Description	Fits
8.671-146.0/ BLAL-16	Belt B-36	Pro Buff, Pioneer, Other Popular Brands
8.682-880.0/ BLE-1	Belt B-31	Pro Buff, Pioneer, Other Popular Brands
8.672-493.0/ BLE-2	Belt B-32	Pro Buff, Pioneer, Other Popular Brands
8.663-464.0/ BLE-4	Belt B-33	Pro Buff, Pioneer, Other Popular Brands
8.663-533.0/ BLE-5	Belt BX38	Pro Buff, Pioneer, Other Popular Brands
8.663-531.0/ BLE-6	Belt BX48	Pro Buff, Pioneer, Other Popular Brands
8.663-537.0/ BLE-9	Belt B-40	Pro Buff, Pioneer, Other Popular Brands
8.663-532.0/ BLE-10	Belt B-49	Pro Buff, Pioneer, Other Popular Brands
8.664-393.0	Belt BX50	Pro Buff, Pioneer, Other Popular Brands
8.688-950.0	Belt BX56	Pro Buff, Pioneer, Other Popular Brands
8.663-526.0/ BLE-11	Belt BX51	Pro Buff, Pioneer, Other Popular Brands

Propane Fuel Parts

GRACO#/Old Graco#	Description	Fits
8.663-664.0/ PB-1	Reg. Beam 50 w/Lock Off	Pro Buff, Pioneer, Other Popular Brands
8.663-613.0/ PB-2	Filter - Lock Off Impco	Pro Buff, Pioneer, Other Popular Brands
8.671-742.0/ PB-13	Coupler-Female	Pro Buff, Pioneer, Other Popular Brands
8.663-447.0/ PB-14	Filter - Propane	Pro Buff, Pioneer, Other Popular Brands
8.663-673.0/ PB-26	Spud In	Pro Buff, Pioneer, Other Popular Brands
8.663-668.0/ PB-28	3/8" Fuel Hose (Length by ft)	Pro Buff, Pioneer, Other Popular Brands
8.663-710.0/ PB-50	Reg. Beam 50E w/o Vacuum lock-off	Pro Buff, Pioneer, Other Popular Brands
8.663-667.0/ PB-50-N	Regulator Nolff's	Pro Buff, Pioneer, Other Popular Brands
8.663-585.0/ PB-51	Kit, Rebuilding Beam 50E (PB-50)	Pro Buff, Pioneer, Other Popular Brands
8.663-670.0/ PB-52	Kit, Rebuilding Beam 50 (PB-1)	Pro Buff, Pioneer, Other Popular Brands
8.663-563.0/ PB-81	Electric Lock Off Filter Nolff's	Pro Buff, Pioneer, Other Popular Brands
8.663-688.0/ PB-82	Universal Tank Clamp	Pro Buff, Pioneer, Other Popular Brands
8.663-669.0/ PB-153	Regulator	Century G-85-4012



Propane Burnisher Parts



8.663-343.0



8.663-592.0



8.672-198.0

Miscellaneous

GRACO#/Old Graco#	Description	Fits
8.660-861.0/ GRA-2000	Handle Grip	Pro Buff, Pioneer, Other Popular Brands
8.663-343.0/ PB-3	Starter - Tecumseh	Pro Buff, Pioneer, Other Popular Brands
8.684-755.0/ PB-4L	Left Hand Throttle Cable	Pro Buff, Pioneer, Other Popular Brands
8.684-756.0/ PB-4R	Right Hand Throttle Cable	Pro Buff, Pioneer, Other Popular Brands
8.660-970.0/ PB-12	Velcro Snap Tabs	Pioneer
8.663-555.0/ PB-46	Skirt Velcro	Pioneer 28" IN-2489
8.684-751.0/ PB-46-H	Hook Velcro (to attach PB-46 to machine)	
8.663-592.0/ PB-49	Hour Meter	Pioneer, Other Popular Brands
8.672-198.0/ PB-157	Carbon Monoxide Detector	Pioneer, Other Popular Brands

Pad Driver Assemblies & Parts

GRACO#	Description	Fits
8.665-214.0	Pulley, Idler 4"	Eagle, Advance Pro27, and others
8.664-218.0	Flange, Drive Hub	Eagle, Advance, and other Propane Burnishers
8.665-027.0	Bearing/Shaft Assy., Front Housing	Eagle, Advance, and others
8.686-425.0	27" Metal Pad Driver Assembly, Complete	Many 27" Propane Burnishers
8.670-482.0	27" Pad Driver, Adhesive Facing Only	Many 27" Propane Burnishers with rigid pad drivers
8.669-485.0	24" Flex Pad Driver Only	Eagle, Advance and other brands
8.670-481.0	21" Flex Pad Driver Only	Eagle, Advance and other brands
9.848.607.0	21" Flex Pad Driver Assy Complete	
9.848.608.0	24" Flex Pad Driver Assy Complete	
9.848.609.0	27" Flex Pad Driver Assy Complete	

Propane Burnisher Parts



8.663-441.0



8.673-119.0



8.674-379.0



8.672-496.0



8.663-702.0



8.689-939.0



8.806-152.0

Wheels

GRACO#/Old Graco#	Description	Fits
8.663-441.0 / PB-5	5" Wheel w/Bracket, Urethane	Pro Buff, Other Popular Brands
8.848-063.0 / PB-6	5" Heavy Duty Wheel Only, Black Rubber	Pro Buff, Other Popular Brands
8.663-712.0 / PB-7	6" Heavy Duty Wheel Only, Black Rubber	Pro Buff, Pioneer, Other Popular Brands
8.660-948.0 / PB-39	3" Swivel Caster	Pro Buff, Pioneer, Other Popular Brands
8.663-702.0	Wheel w/ Bracket 6.75" Overall Hgt	EAGLE 1205, ADVANCE 56649823
8.689-939.0	Wheel Only, 5" Blue Poly, Fits 3/8" Axle	For our 8.663-441.0 PB-5 Rigid Caster Assy Fits: Many Propane Burnishers
8.806-152.0	Wheel 6", 3/8" Bore, Gray Rubber w/Thread Guards	EAGLE 1200

Engine Parts



8.626-292.0



8.661-948.0

Accessories

GRACO#/Old Graco#	Description
8.626-292.0 / PB-9	Steel Tank - 20 lb. w/Gauge and Filler Valve, UL Approved. To fit most propane burnishers
8.672-201.0 /PB-9A	Aluminum Tank W/Gauge #20
8.661-948.0 / PB-145	Engine Maintenance Meter (Hour)



8.663-579.0



8.689-137.0

Starter Solenoids - 12 Volt

GRACO#	Description
8.663-579.0	12 Volt, 3 Post
8.689-137.0	12 Volt,



8.684-268.0



8.684-258.0



8.684-263.0



9.848-057.0



8.620-111.0

Flojet

GRACO#/Old Graco#	Specifications	Manufacturer's #
8.684-258.0/ M-40	85 PSI, 95 PSI Pressure Switch, 1.8 GPM Max Flow	2100-032
8.684-263.0/ M-41	100 PSI, Fan Cooled	2130-533
8.669-444.0/ M-42	50 PSI By-Pass - EPDM, 45 PSI Max Pressure	2100-549
9.848-057.0/ M-43	100 PSI, By-Pass EPDM	2130-517
8.620-111.0/ M-108	Solution Pump 120V, 60HZ	603653
8.670-729.0	Pump 36 V	2100-789, Minuteman 742709

Flojet Pump Parts

8.684-259.0/ M-40-CK	Check Valve Assembly - Santoprene	Model 2100-032
8.684-260.0/ M-40-CKV	Check Valve Assembly - Viton	Model 2100-032
8.684-261.0/ M-40-NPK	Pump Repair Kit	Model 2100
8.684-262.0/ M-40-PS	Pressure Switch	Model 2000
8.684-264.0/ M-41-CKB	Check Valve Assembly - Buna	Model 2130-032
8.684-265.0/ M-41-NPK	Pump Repair Kit	Model 2130
8.613-708.0/ M-41-PS	Pressure Switch	Model 2100-549
9.848-268.0/ M-42-CKB	Check Valve Assembly - Buna	Model 2000
8.684-270.0/ M-43-CK	Check Valve Assembly - EPDM	Model 2130-517, 2130-533



8.684-254.0



8.671-735.0



8.602-634.0



8.660-106.0



8.663-417.0



8.662-172.0

Little Giant

GRACO#/Old Graco#	Specifications	Manufacturer #
8.684-254.0/ M-20	50 PSI w/Vent Tube	35-OM

Shurflo

GRACO#/Old Graco#	Specifications	Manufacturer #
8.660-106.0/ M-103	8000, 60PSI 115VHC	8005-233-236
8.671-735.0/ M-104	8000 100 PSI	8000-713-238
8.602-634.0/ M-105	36V 100 PSI	8006-882-288
8.663-417.0/ M-106	ASM 12V	100-000-21
8.662-172.0/ M-107	100 PSI 24VDC	8000-853-238
8.684-234.0/ M-103-DK	Diaphragm Kit	Model 8000
8.672-089.0/ M-103-PS	Pressure Switch	Model 8000
8.684-236.0/ M-103-VK	Valve Kit	Model 8000
8.684-238.0/ M-104-PS	Pressure Switch	Model 8000

To Assure Proper Replacement Parts, Please Have Pump Model # Available.
Call Your Customer Service Representative for Price and Availability on Pumps Not Shown.

Pumps



8.684-275.0



8.684-280.0

Barbs

GRACO#/Old Graco#	Specifications	Manufacturer #
8.684-275.0/ M-50-B	3/8 Nipple x 3/8 Barb	62011
8.684-276.0/ M-51-B	1/2 Nipple x 1/2 Barb	62012

Nipples

GRACO#/Old Graco#	Specifications	Manufacturer #
8.684-280.0/ M-55-N	1/2 x 1/2	62077



8.663-337.0



8.663-337.0

Elbows

GRACO#/Old Graco#	Specifications	Manufacturer #
8.684-275.0/ M-48-E	3/8 Barb x 3/8 Barb	62038
8.684-276.0/ M-49-E	1/2 Barb x 1/2 Barb	62040

Tees

GRACO#/Old Graco#	Specifications	Manufacturer #
8.664-403.0/ M-52-T	3/8 x 3/8 x 3/8	62065
8.684-278.0/ M-53-T	1/2 x 1/2 x 1/2	62104



8.684-271.0

Filters

GRACO#/Old Graco#	Specifications	Manufacturer #
8.684-275.0/ M-45-F	3/8 Barb x 3/8 Barb	1600-000
8.684-276.0/ M-47-F	1/2 Barb x 1/2 Barb	1600-002



Cable Ties

Cable Ties - Nylon, 100/pack

GRACO#/Old Graco#	Length	Max Loop Dia
8.683-500.0/ EW-10	6"	1.25 Inch
8.683-501.0/ EW-11	7"	1.5 Inches
8.683-502.0/ EW-12	14.5"	4 Inches



Lubricant

Spray Lubricants

GRACO#/Old Graco#	Description
8.685-106.0/ SS-3	CRC 5-56 11 oz. can, 12/case Loosens Rusted Parts; Stops Squeaks; Protects Metals; Starts Wet Engines
8.685-107.0/ SS-4	Silicone Spray 11 oz. can, 12/case Stops Squeaks; Leaves Protective Film



Tape

Tape

GRACO#/Old Graco#	Description	Color
8.685-099.0/ SS-1	Electrical Tape 3/4" x 60' Roll	Black
8.685-104.0/ SS-2	Teflon Tape 1/2" x 520" Roll	White



Bulk Wire

General Purpose Primary Wire 100% Spool

GRACO#/Old Graco#	Gauge	Color
8.683-512.0/ EW-1B	10	Black
8.683-513.0/ EW-1W	10	White
8.683-511.0/ EW-1R	10	Red
8.683-522.0/ EW-2B	14	Black
8.683-525.0/ EW-2W	14	White
8.683-524.0/ EW-2R	14	Red
8.683-533.0/ EW-3B	16	Black
8.683-535.0/ EW-3W	16	White
8.683-534.0/ EW-3R	16	Red

Other gauges and colors available upon request

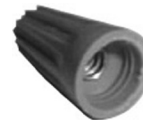

Wire Nuts

Wire Nuts - 100/pack

GRACO#/Old Graco#	Gauge	Color
8.683-503.0/ EW-13	22 - 18	Black
8.683-504.0/ EW-14	18 - 16	Blue
8.683-505.0/ EW-15	16 - 14	Orange
8.683-506.0/ EW-16	14 - 12	Yellow



8.685-344.0

Miscellaneous

GRACO#/Old Graco#	Description
8.683-459.0/ SS-17	Loc-tite 242, .5 ml, Locking Compound
8.685-344.0/ VG-1	Vacuum Test Gauge (water lift)



Ring Terminal



Push-On Terminal



Connector

Ring Terminals - Insulated 100/Pack

GRACO#/Old Graco#	Wire Size	Insulation	Stud Size
8.683-507.0/ EW-17	22 - 18	Red	#10
8.683-508.0/ EW-18	16 - 14	Blue	#8
8.683-509.0/ EW-19	16 - 14	Blue	#10
8.683-513.0/ EW-20	16 - 14	Blue	1/4"
8.683-514.0/ EW-21	16 - 14	Blue	5/16"
8.683-515.0/ EW-22	16 - 14	Blue	3/8"
8.683-516.0/ EW-23	12 - 10	Yellow	#10
8.683-517.0/ EW-24	12 - 10	Yellow	1/4"
8.683-518.0/ EW-25	12 - 10	Yellow	5/16"
8.683-519.0/ EW-26	12 - 10	Yellow	3/8"

Miscellaneous Terminals 100/Pack

GRACO#/Old Graco#	Terminal Type	Wire Size	Color
8.683-520.0/ EW-27	Spade	16-14	Blue
8.683-521.0/ EW-28	Push-On Male	16-14	Blue
8.683-531.0/ EW-36	Push-On Female	12-10	Non-Insulated
8.683-532.0/ EW-37	Push-On Female	22-18	Non-Insulated
8.683-536.0/ EW-40	Connector	16-14	Red
8.683-537.0/ EW-41	Connector	12-10	Blue
8.683-538.0/ EW-42	Connector	16-14	Yellow

Shop Supplies

Ring Terminals - Non-Insulated 100/Pack

GRACO#/Old Graco#	Wire Size	Stud Size
8.683-526.0/ EW-30	22 - 18	#10
8.683-527.0/ EW-31	16 - 14	#8
8.683-528.0/ EW-33	16 - 14	#10
8.683-529.0/ EW-34	12 - 10	3/8"
8.683-530.0/ EW-35	12 - 10	3/8"



Terminal Kit

Terminal Kit

GRACO#/Old Graco#	Wire Size	Stud Size	
8.683-539.0/ EW-44			
Qty	Description - Vinyl Insulated	Gauge	Size
15	Ring Terminal	16-14	#10
12	Ring Terminal	16-14	5/16"
24	Ring Terminal	16-14	#10
10	Butt Connector	12-10	
10	Female Push-on Terminal	16-14	.250"
10	Male Push-on Terminal	16-14	.250"
20	Butt Connector	16-14	
10	Ring Terminal	12-10	5/16"
10	Spade Terminal	12-10	#10
10	Ring Terminal	12-10	#10



Kits

GRACO#/Old Graco#	Description
8.685-108.0/ SS-5	Cotter Pin Kit

Includes:

Qty	Description
100	1/16" x 1"
100	3/32" x 1"
100	1/8" x 1"
40	5/32" x 1-1/2"
20	3/16" x 2"
60	1/8" x 1-1/2"
420	Total Pieces

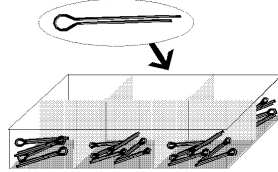

GRACO#/Old Graco#	Description
8.685-101.0/ SS-10	"SH" Retaining Ring Kit

Includes:

Qty	Description
10	1/4"
10	5/16"
7	7/16"
10	3/8"
7	5/8"
7	1/2"
3	3/4"
3	1"
55	Total Pieces

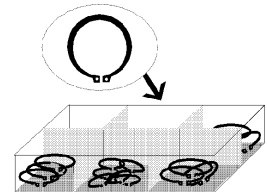

GRACO#/Old Graco#	Description
8.685-109.0/ SS-6	Woodruff Key Kit

Includes:

Qty	Description
18	1/8" x 1/2" - #3
12	1/8" x 5/8" - #5
12	5/32" x 5/8" - #6
12	3/16" x 3/4" - #9
10	1/4" x 7/8" - #A
8	1/4" x 1" - #15
72	Total Pieces

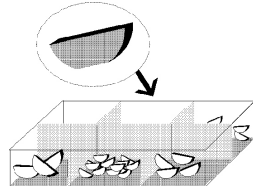

GRACO#/Old Graco#	Description
8.685-101.0/ SS-11	"E" Clip Kit

Includes:

Qty	Description
30	1/8"
30	1/16"
15	3/16"
15	1/4"
10	5/8"
10	3/8"
10	1/2"
5	3/4"
120	Total Pieces

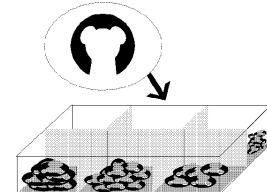

GRACO#/Old Graco#	Description
8.685-110.0/ SS-8	"O" Ring Kit

Includes:

Qty	Description
20	5/32" ID x 9/32" OD
15	1/4" ID x 3/8" OD
10	7/16" ID x 5/8" OD
10	9/16" ID x 3/4" OD
10	3/4" ID x 15/16" OD
7	1" ID x 1-1/4" OD
72	Total Pieces

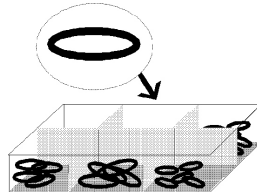

GRACO#/Old Graco#	Description
8.685-102.0/ SS-12	Machinery Key Kit

Includes:

Qty	Description
20	1/8" x 1/8" x 1-1/2"
12	3/16" x 1/4" x 1-1/2"
12	3/16" x 3/16" x 1-1/2"
10	1/4" x 1/4" x 1-1/2"
8	5/16" x 5/16" x 1-1/2"
8	3/8" x 3/8" x 1-1/2"
70	Total Pieces

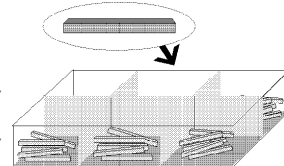

GRACO#/Old Graco#	Description
8.685-111.0/ SS-9	"HO" Retaining Ring Kit

Includes:

Qty	Description
10	1/4"
10	5/16"
10	3/8"
5	5/8"
7	7/16"
7	1/2"
3	3/4"
3	1"
55	Total Pieces

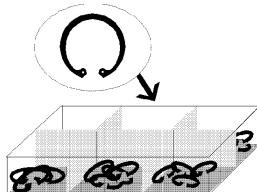

Shop Supplies



8.600-062.0

Popular Universal Floor Machine Tank

8.600-062.0/ MC-3500
(Includes valve, handle, tubing and brackets)

- Black
- 4 Gallon Heavy Duty X-Link Poly Construction
- Withstands Temperatures Ranging from -40 to 200 Degrees F
- Extra Wide Mouth Allows Spill-Free Filling
- For Floor Machines with Round Handle Tubes Only

Replacement Parts for MC-3500

GRACO#/Old Graco#	Description
MC-3500-K	Special Bracket Set for MC-3500. For Squared Handle Tubes Only. (Advance Only)
8.663-461.0/ MC-3500-H	Valve Handle
8.684-355.0	Replacement Valve



Advance

GRACO#/Old Graco#	Material Description	Compatible OEM Part Number	Fits Machines
86619720/ AD-240-2B	SQ BLADE, GUM, FRONT	008602	BA 5321
98485970/ AD-32-4	SQUEEGEE SET	5604015	CONVERTAMATIC 32B
86803110/ AD-20-C	Aluminum Channel (QBA) w/2x 23.5" Red-Ha	5638225	CONVERTAMATIC 20B
98485240/ AD-34-2	SQUEEGEE SET GUM(ADV) (QBA)	5639709	ConvertaMAX 28
98485240/ AD-34-2	SQUEEGEE SET GUM(ADV) (QBA)	5639709	ConvertaMAX 34
98485240/ AD-34-2	SQUEEGEE SET GUM(ADV) (QBA)	5639709	I-MAX 28HD
98485240/ AD-34-2	SQUEEGEE SET GUM(ADV) (QBA)	5639709	I-MAX 34HD
86804310/ AD-38-S	SPLASHGUARD BLADE (QBA)	5640028	CONVERTAMATIC 38BD
86805110/ AD-LV-6	SKIRT	5646720	Retriever 134B
86805070/ AD-LV-2	SKIRT HOPPER	5647533	LITER VAC
86638050	FRONT BLADE	08603830	ADVINITY 20D/X20D/X20C/X24D
86638050	FRONT BLADE	08603830	RAZOR
86638060	REAR BLADE	08603832	ADVINITY 20D/X20D/X20C/X24D
86638060	REAR BLADE	08603832	RAZOR
98486690	BLADE KIT, RED	56111650	CONDOR XL
98486700	BLADE KIT, TAN GUM	56111652	CONDOR XL
98486830	BLADE KIT- GUM 26-28	56112247	SC750 26/28"
98486830	BLADE KIT- GUM 26-28	56112247	SC800 26/28"
98486850	BLADE KIT- RED 26-28	56112248	SC750 26/28"
98486850	BLADE KIT- RED 26-28	56112248	SC800 26/28"
98486840	BLADE KIT- GUM 32-34	56112250	SC750 32/34"
98486840	BLADE KIT- GUM 32-34	56112250	SC800 32/34"
98486860	BLADE KIT- RED 32-34	56112251	SC750 32/34"
98486860	BLADE KIT- RED 32-34	56112251	SC800 32/34"
98485870/ AD-20-4N	SQUEEGEE SET (QBA)	56204006	CONVERTAMATIC 20B
98485320/ AD-24-4	SQUEEGEE SET (QBA)	56204007	CONVERTAMATIC 24B
86803950/ AD-32-8N	SQUEEGEE SET (NEO) (QBA)	56204033	CONVERTAMATIC 32B
86803150/ AD-20T-5	SQUEEGEE SET (QBA)	56205097	20" SQUEEGEE TOOL
86803350/ AD-24T-5	SQUEEGEE BLADE (QBA)	56206107	24" SQUEEGEE TOOL
98486470	SQUEEGEE SET, RED	56303471	CAPTOR 4300
98486480	SQUEEGEE SET, RED	56303472	CAPTOR 4800
98486490	SQUEEGEE SET, RED 48	56305686	CAPTOR 4800
98486500	SQUEEGEE SET, RED 43	56305695	CAPTOR 4300
98486520	SQUEEGEE SET, RED 54	56305696	CAPTOR 5400
98486520	SQUEEGEE SET, RED 54	56305696	HAREM CAPTOR
98486320	SIDE BLADE KIT-RED (CONTAINS 4 BLADES)	56305697	CAPTOR 4300
98486320	SIDE BLADE KIT-RED (CONTAINS 4 BLADES)	56305697	CAPTOR 4800
98486320	SIDE BLADE KIT-RED (CONTAINS 4 BLADES)	56305697	CAPTOR 5400
98486320	SIDE BLADE KIT-RED (CONTAINS 4 BLADES)	56305697	HAREM CAPTOR
98485750/ AD-24V-2	BLADE KIT 24 ADVENGER (QBA)	56314054	ADVENGER
98485900/ AD-32V-2	BLADE KIT ADVENGER 32 (QBA)	56314060	ADHANCER
98485900/ AD-32V-2	BLADE KIT ADVENGER 32 (QBA)	56314060	ADVENGER
98486370	BLADE KIT, GUM, 28" DECK	56314126	ADGRESSOR
98486370	BLADE KIT, GUM, 28" DECK	56314126	ADVENGER
86859520	BLADE, REAR 3/16 GUM (32")	56314342	Adgressor
86859520	BLADE, REAR 3/16 GUM (32")	56314342	ADVENGER
98486530	BLADE KIT, RED 35" DISK	56314846	ADGRESSOR
98486540	BLADE KIT, RED 38" DISK	56314848	ADGRESSOR
98486550	BLADE KIT, RED, CLY DECK	56314860	ADGRESSOR
98486560	BLADE KIT, TAN GUM 32" DISK	56314914	ADGRESSOR



Advance (con't)

GRACO#/Old Graco#	Material Description	Compatible OEM Part Number	Fits Machines
86899060	Ad-26D-SSkirt Rubber, Convertamatic 26D	56315275	CONVERTAMATIC 26D-C
98486880	BLADE SET GUM 24"	56315347	ADHANCER
98486880	BLADE SET GUM 24"	56315347	CONVERTAMATIC 24D
98486880	BLADE SET GUM 24"	56315347	WARRIOR ST
98485850/ AD-26D-2	Squeegee Set, (QBA) Convertamatic 26C-D,28C-D	56315348	34 RST
98485850/ AD-26D-2	Squeegee Set, (QBA) Convertamatic 26C-D,28C-D	56315348	Adhancer
98485850/ AD-26D-2	Squeegee Set, (QBA) Convertamatic 26C-D,28C-D	56315348	Adphibian
98485850/ AD-26D-2	Squeegee Set, (QBA) Convertamatic 26C-D,28C-D	56315348	AquaPLUS
98485850/ AD-26D-2	Squeegee Set, (QBA) Convertamatic 26C-D,28C-D	56315348	CONVERTAMATIC 26D-C
98485850/ AD-26D-2	Squeegee Set, (QBA) Convertamatic 26C-D,28C-D	56315348	Warrior ST
98486570	BLADE KIT, RED	56315720	ADGRESSOR
98486580	BLADE KIT, TAN GUM	56315722	ADGRESSOR
98485030/ AD-200-2	SQUEEGEE SET (QBA)	56324254	Convertamatic 200B
98485030/ AD-200-2	SQUEEGEE SET (QBA)	56324254	Convertamatic 200E
98485030/ AD-200-2	SQUEEGEE SET (QBA)	56324254	Convertamatic 200LX
98485030/ AD-200-2	SQUEEGEE SET (QBA)	56324254	Convertamatic 200BD
86803070	BLADE, NEO 1-1/4"x1/8"x24"-7 Holes	56361218	CONVERTAMATIC 20B
86803080	BLADE, NEO 1-1/8"x1/16"x24" -7 Holes	56361221	CONVERTAMATIC 20B
86803060	BLADE, NEO 1-3/8"x1/8"x24-1/4"-7 Holes	56361225	CONVERTAMATIC 20B
86803180/ AD-21-4B	BLADE, NEO (QBA) 1-1/4"x1/8"x26" - 8 Hol	56363847	CONVERTAMATIC 21B
86803220/ AD-21-C	SQUEEGEE CARTRIDGE (QBA) (24" CHANNEL, 2	56363882	CONVERTAMATIC 21B
86803220/ AD-21-C	SQUEEGEE CARTRIDGE (QBA) (24" CHANNEL, 2	56363882	Sprite Air Scoop
86803190/ AD-21-4C	BLADE, NEO (QBA) 1-1/8"x1/16"x26" - 8 Ho	56370932	CONVERTAMATIC 21B
86803170/ AD-21-4A	BLADE, TAN GUM (QBA) 1-3/8"x1/8"x26" - 8	56370967	CONVERTAMATIC 21B
86803310/ AD-24-4C	BLADE, NEO (QBA) 1-1/8"x1/16"x23" -10 Ho	56371033	CONVERTAMATIC 24B
86803280/ AD-24-4A	BLADE, TAN GUM (QBA) 1-3/8"x1/8"x28" - 1	56371084	CONVERTAMATIC 24B
86803300/ AD-24-4B	BLADE, NEO (QBA) 1-1/4"x1/8" - 10 Holes	56371106	CONVERTAMATIC 24B
86803650/ AD-280-C	SQUEEGEE CARTRIDGE (QBA)	56376288	TRAC 280
98485890/ADV 56376548 Graco AD-280-3	SQUEEGEE SET 280-BHD (QBA)	56376548	TRAC 280
86619800/ AD-24-S	SPLASHGUARD	56377872	Convertamatic 240LX
86619800/ AD-24-S	SPLASHGUARD	56377872	Hydro-Retriever 240HD
86619820/ AD-32-S	SPLASHGUARD-32	56381349	Convertamatic 32B/32BD/38BD
86619820/ AD-32-S	SPLASHGUARD-32	56381349	Hydro-Retriever 320BHD/380BHD
86618650/ AD-20-CS	SQUEEGEE BLADE CARTRIDGE 20"	56382356	Convertamatic 20B
86803030/ AD-200-R	BLADE RIGHT (QBA)	56388402	WHIRLAMATIC 2000B
98486590	BLADE KIT, TAN GUM	56390756	ADGRESSOR
98486600	BLADE KIT, TAN GUM	56390788	ADGRESSOR
98486610	BLADE KIT, TAN GUM, CYL	56390791	ADGRESSOR
98486620	BLADE KIT, TAN GUM	56390796	ADGRESSOR
86899080	BLADE	56391333	CONVERTAMATIC 260B
86899080	BLADE	56391333	CONVERTAMATIC 265LX
86899080	BLADE	56391333	CONVERTAMATIC 28LX
86899080	BLADE	56391333	CONVERTAMAX 20/26
86899080	BLADE	56391333	CONVERTAMAX 28
86899080	BLADE	56391333	IMAX 28HD
86899080	BLADE	56391333	LYNX 285
98485090/ AD-325-3	SQUEEGEE SET (QBA)	56392250	I-MAX 28HD
86803910/ AD-325-S	BLADE(LX) (QBA)	56392416	Convertamatic 325LX / 385LX
86803910/ AD-325-S	BLADE(LX) (QBA)	56392416	Hydro-Retriever 325HD / 385HD
86803910/ AD-325-S	BLADE(LX) (QBA)	56392416	Lynx 325 / 385

Squeegees



Advance (con't)

GRACO#/Old Graco#	Material Description	Compatible OEM Part Number	Fits Machines
98485040/ AD-240-2	SQUEEGEE SET (QBA)	56393395	BA 5321
98485040/ AD-240-2	SQUEEGEE SET (QBA)	56393395	BA 5321
98485040/ AD-240-2	SQUEEGEE SET (QBA)	56393395	BA 5321D
98485040/ AD-240-2	SQUEEGEE SET (QBA)	56393395	BA 5321D
98485040/ AD-240-2	SQUEEGEE SET (QBA)	56393395	CONVERTAMATIC 240LX
98485040/ AD-240-2	SQUEEGEE SET (QBA)	56393395	Micromax 17E
98485040/ AD-240-2	SQUEEGEE SET (QBA)	56393395	Micromax 17E
98485040/ AD-240-2	SQUEEGEE SET (QBA)	56393395	Razor E 17
98485040/ AD-240-2	SQUEEGEE SET (QBA)	56393395	Razor E 17
86804280/ AD-38N-C	CARTRIDGE HARD (QBA)	56395799	CONVERTAMATIC 38BD
86856980	SKIRT BLADE RIGHT	56396004	CMAX 28ST
86856970	SKIRT BLADE LEFT	56396005	CMAX 28ST
86804100	BLADE, FRONT RED (QBA)	56397089	ConvertaMAX 28
86804100	BLADE, FRONT RED (QBA)	56397089	ConvertaMAX 34
86804100	BLADE, FRONT RED (QBA)	56397089	I-MAX 28HD
86804100	BLADE, FRONT RED (QBA)	56397089	I-MAX 34HD
98485860/ AD-34R-2	BLADE SET, RED (QBA)	56397106	Warrior 28/32
86804070/ AD-34-2B	BLADE, FRONT NOTCHED GUM (QBA)	56397362	ConvertaMAX 28
86804070/ AD-34-2B	BLADE, FRONT NOTCHED GUM (QBA)	56397362	ConvertaMAX 34
86804070/ AD-34-2B	BLADE, FRONT NOTCHED GUM (QBA)	56397362	I-MAX 28HD
86804070/ AD-34-2B	BLADE, FRONT NOTCHED GUM (QBA)	56397362	I-MAX 34HD
86804060/ AD-34-2A	BLADE, REAR GUM(ADV) (QBA)	56397363	ConvertaMAX 28
86804060/ AD-34-2A	BLADE, REAR GUM(ADV) (QBA)	56397363	ConvertaMAX 34
86804060/ AD-34-2A	BLADE, REAR GUM(ADV) (QBA)	56397363	I-MAX 28HD
86804060/ AD-34-2A	BLADE, REAR GUM(ADV) (QBA)	56397363	I-MAX 34HD
86804200/ AD-38-4A	BLADE, TAN GUM (QBA) 1-3/8"x1/8"x42-15/1	56400558	CONVERTAMATIC 38BD
86804210/ AD-38-4B	BLADE, NEO (QBA) 1-1/4"x1/8"x42-15/16" -	56400566	CONVERTAMATIC 38BD
86804220/ AD-38-4C	BLADE, NEO (QBA) 11/8"x1/16"x42-15/16" -	56400574	CONVERTAMATIC 38BD
98485910/ AD-38-4N	SQUEEGEE SET NEO	56400588	CONVERTAMATIC 38BD
86805140/ AD-LV-9	SKIRT	56467330	Retriever 134B
86803820/ AD-32-4A	BLADE, TAN GUM (QBA) 1-3/8"x1/8"x38-15/1	56474645	CONVERTAMATIC 32B
86803830/ AD-32-4B	BLADE, NEO (QBA) 1-1/4"x1/8"x38-15/16" -	56474647	CONVERTAMATIC 32B
86803440/ AD-26-4B	BLADE, NEO1-1/4"x1/8"x31-15/16" - 9 Holes	56550823	CONVERTAMATIC 26B
86803450/ AD-26-4C	BLADE, NEO 1-1/8"x1/16"x31-15/16"- 9 Hol	56550825	CONVERTAMATIC 26B
86803420/ AD-26-4A	BLADE, GUM 1-3/8"x1/8"x31-15/16" - 9 Hol	56550827	CONVERTAMATIC 26B
98485820/ AD-26-4	SQUEEGEE SET (QBA)	56550950	CONVERTAMATIC 26B
86619810/ AD-26-S	SPLASH GUARD 56551127	56551127	Convertamatic 260B
86619810/ AD-26-S	SPLASH GUARD 56551127	56551127	Hydro-Retriever 260BHD
98486660	BLADE KIT, RED	56601094	ADGRESSOR
98486660	BLADE KIT, RED	56601094	Advenger 3400S
98486670	BLADE KIT, 28	56601531	Advenger 2800ST
98486680	BLADE KIT, TAN GUM 34"	56601532	ADGRESSOR
86739860	SQ. BLADE - FRONT -	9096483000	ADVINITY 17/20
86860610	BLADE, REAR GUM	9096484000	ADVINITY 17/20
98486750	SQUEEGEE BLADE KIT	9096860000	ADVINITY 17/20
98486220	Squeegee Set, Red	56315352,56315290	34RST
86618640/ AD-32N-C	CARTRIDGE,32N	56395793	Hydro-Retriever 320BHD
86899070/ AD-285N-2A	BLADE, GUM FRONT	56391334	CONVERTAMATIC 260B
86899070/ AD-285N-2A	BLADE, GUM FRONT	56391334	CONVERTAMATIC 265LX
86899070/ AD-285N-2A	BLADE, GUM FRONT	56391334	CONVERTAMATIC 28LX
86899070/ AD-285N-2A	BLADE, GUM FRONT	56391334	CONVERTAMAX 20/26



Advance (con't)

GRACO#/Old Graco#	Material Description	Compatible OEM Part Number	Fits Machines
86899070/ AD-285N-2A	BLADE, GUM FRONT	56391334	CONVERTAMAX 28
86899070/ AD-285N-2A	BLADE, GUM FRONT	56391334	IMAX 28HD
86899070/ AD-285N-2A	BLADE, GUM FRONT	56391334	LYNX 285
98485060/ AD-285N-2	BLADE KIT, STANDARD (QBA)	56391340	Convertamatic 285LX
98485060/ AD-285N-2	BLADE KIT, STANDARD (QBA)	56391340	Hydro-Retriever 285HD
98485060/ AD-285N-2	BLADE KIT, STANDARD (QBA)	56391340	Lynx 285
98485070/ AD-285N-2	SQUEEGEE SET (QBA)	56391340	Convertamatic 285LX
98485070/ AD-285N-2	SQUEEGEE SET (QBA)	56391340	Hydro-Retriever 285HD
98485070/ AD-285N-2	SQUEEGEE SET (QBA)	56391340	Lynx 285
98485080/ AD-285N-2	SQUEEGEE SET (QBA) gum	56391340	Convertamatic 38LX
98485080/ AD-285N-2	SQUEEGEE SET (QBA) gum	56391340	Hydro-Retriever 3800
98485080/ AD-285N-2	SQUEEGEE SET (QBA) gum	56391340	Hydro-Retriever 380HD
86619720/ AD-240-2	SQ BLADE, GUM, FRONT	008602463	BA 5321D
86619720/ AD-240-2B	SQ BLADE, GUM, FRONT	008602463	Micromax 17E
86619720/ AD-240-2B	SQ BLADE, GUM, FRONT	008602463	Razor E 17
86802780/ AD-17-4	SQUEEGEE SET (QBA)	56204001	CONVERTAMATIC 17B
86802920/ AD-18-4N	SQUEEGEE SET (NEO) (QBA)	56204025	CONVERTAMATIC 18B
86803320/ AD-24-4N	SQUEEGEE SET (NEO) (QBA)	56204027	CONVERTAMATIC 24B
86803090/ AD-20-4NN	SQUEEGEE SET (NEO) (QBA)	56204029	CONVERTAMATIC 20B
86802770/ AD-14T-5	SQUEEGEE SET (QBA)	56204295	14" SQUEEGEE TOOL
86697610/ AD-26V-2B	FRONT BLADE	56314029	Advenger
86803550/ AD-26V-2A	BLADE REAR (QBA) 26 & 28 ADVENGER	56314050	ADVENGER
86859490	BLADE, REAR 3/16 GUM (28")	56314137	Adgressor
86859490	BLADE, REAR 3/16 GUM (28")	56314137	ADVENGER
86859540	BLADE, FRONT 3/16 GUM (28")	56314146	Adgressor
86859540	BLADE, FRONT 3/16 GUM (28")	56314146	ADVENGER
98485730/ AD-26V-2 AD-28V-2	BLADE KIT (QBA) 26 AND 28 ADVENGER, WARRIOR ST 1red inside/	56314303	ADVENGER
98485880/ AD-26VR-2	BLADE KIT 26,28 (QBA) RED	56314304	ADVENGER
86803380/ AD-24V-2B	BLADE REAR 24 ADVENGER (QBA)	56314314	ADVENGER
86803370/ AD-24V-2A	BLADE REAR 24 ADVENGER (QBA)	56314315	ADVENGER
86859480	BLADE, OUTER 1/4 GUM (EA)	56314340	Adgressor
86859480	BLADE, OUTER 1/4 GUM (EA)	56314340	ADVENGER
86859530	BLADE, FRONT 3/16 GUM (32")	56314343	Adgressor
86859530	BLADE, FRONT 3/16 GUM (32")	56314343	ADVENGER
98481960	SKIRTKIT, ADVENGER 28" GUM	56314397	Adgressor
98481960	SKIRTKIT, ADVENGER 28" GUM	56314397	ADVENGER
86804490/ AD-CYLR-S	SKIRT, CYLINDRICAL SCRUB HEAD, 1/4" RED	56314530	Adgressor
86804490/ AD-CYLR-S	SKIRT, CYLINDRICAL SCRUB HEAD, 1/4" RED	56314530	ADVENGER
86804490/ AD-CYLR-S	SKIRT, CYLINDRICAL SCRUB HEAD, 1/4" RED	56314530	Hydro-Retriever 2042
86804490/ AD-CYLR-S	SKIRT, CYLINDRICAL SCRUB HEAD, 1/4" RED	56314530	Hydro-Retriever 2800
86804490/ AD-CYLR-S	SKIRT, CYLINDRICAL SCRUB HEAD, 1/4" RED	56314530	Hydro-Retriever 3200
86804490/ AD-CYLR-S	SKIRT, CYLINDRICAL SCRUB HEAD, 1/4" RED	56314530	Hydro-Retriever 3800
86859470	BLADE, OUTER 1/4 RED GUM (EA)	56314547	Adgressor
86859470	BLADE, OUTER 1/4 RED GUM (EA)	56314547	ADVENGER
98486160	BLADE SET, RED AD-W2832-2R	56314865	Warrior 28/32
86859510	BLADE, INNER 1/4 GUM (EA)	56314883	Adgressor
86859510	BLADE, INNER 1/4 GUM (EA)	56314883	ADVENGER
86859500	BLADE, INNER 1/4 RED GUM (EA)	56314895	Adgressor
86859500	BLADE, INNER 1/4 RED GUM (EA)	56314895	ADVENGER
98481970	Kit, Red Gum Rubber 28 Disk (Standard)	56314917	Adgressor

Squeegees



Advance (con't)

GRACO#/Old Graco#	Material Description	Compatible OEM Part Number	Fits Machines
98481970	Kit, Red Gum Rubber 28 Disk (Standard)	56314917	ADVENGER
98481940	SKIRT KIT, ADVENGER 32" RED	56314918	Adgressor
98481940	SKIRT KIT, ADVENGER 32" RED	56314918	ADVENGER
98486220	Squeegee Set, Red	56315352, 56315290	CONVERTAMATIC 26D-C
98486220	Squeegee Set, Red	56315352, 56315290	Convertamic 24D
98486220	Squeegee Set, Red	56315352, 56315290	Warrior ST
98486220	Squeegee Set, Red	56315352, 56315290	Adhancer Narrow Isle
86805180/ AD-W2832-2B	SQUEEGEE FRONT FOR WARRIOR 28/32, GUM	56315631	Warrior 28/32
86805170/ AD-W2832-2A	SQUEEGEE REAR FOR WARRIOR 28/32, GUM	56315673	Warrior 28/32
98485250/ AD-W2832-2	SQUEEGEE SET FOR WARRIOR 28/32, GUM	56315674	Warrior 28/32
86802980/ AD-200-2B	BLADE, TAN GUM (QBA) 3"x1/4"x26-15/16"	56324025	Convertamatic 200B
86802980/ AD-200-2B	BLADE, TAN GUM (QBA) 3"x1/4"x26-15/16"	56324025	Convertamatic 200E
86802980/ AD-200-2B	BLADE, TAN GUM (QBA) 3"x1/4"x26-15/16"	56324025	Convertamatic 200LX
86802980/ AD-200-2B	BLADE, TAN GUM (QBA) 3"x1/4"x26-15/16"	56324025	Convertamatic 200BD
86802970/ AD-200-2A	BLADE, NEO (QBA) 3"x1/8"x25-7/16" -50 SI	56324026	Convertamatic 200B
86802970/ AD-200-2A	BLADE, NEO (QBA) 3"x1/8"x25-7/16" -50 SI	56324026	Convertamatic 200E
86802970/ AD-200-2A	BLADE, NEO (QBA) 3"x1/8"x25-7/16" -50 SI	56324026	Convertamatic 200LX
86802970/ AD-200-2A	BLADE, NEO (QBA) 3"x1/8"x25-7/16" -50 SI	56324026	Convertamatic 200BD
86646130/ AD-200N-2A	BLADE	56324322	Convertamatic 200B, E
86646130/ AD-200N-2A	BLADE	56324322	Convertamatic 200B/LX
86646130/ AD-200N-2A	BLADE	56324322	Convertamatic 200LX
86646130/ AD-200N-2A	BLADE	56324322	Convertamatic 20B
86646130/ AD-200N-2A	BLADE	56324322	Hydro-Retriever 200HD
86803020/ AD-200N-2B	BLADE, NEO (QBA) 2-1/4"x1/8"x25-3/4" -6	56324325	Convertamatic 200B, E
86803020/ AD-200N-2B	BLADE, NEO (QBA) 2-1/4"x1/8"x25-3/4" -6	56324325	Convertamatic 200B/LX
86803020/ AD-200N-2B	BLADE, NEO (QBA) 2-1/4"x1/8"x25-3/4" -6	56324325	Convertamatic 200LX
86803020/ AD-200N-2B	BLADE, NEO (QBA) 2-1/4"x1/8"x25-3/4" -6	56324325	Convertamatic 20B
86803020/ AD-200N-2B	BLADE, NEO (QBA) 2-1/4"x1/8"x25-3/4" -6	56324325	Hydro-Retriever 200HD
98485050/ AD-200N-2	SQUEEGEE SET (QBA) (after sn# 511035)	56324385	Convertamatic 200B, E
98485050/ AD-200N-2	SQUEEGEE SET (QBA) (after sn# 511035)	56324385	Convertamatic 200B/LX
98485050/ AD-200N-2	SQUEEGEE SET (QBA) (after sn# 511035)	56324385	Convertamatic 200LX
98485050/ AD-200N-2	SQUEEGEE SET (QBA) (after sn# 511035)	56324385	Convertamatic 20B
98485050/ AD-200N-2	SQUEEGEE SET (QBA) (after sn# 511035)	56324385	Hydro-Retriever 200HD
86802900/ AD-18-4B	BLADE, NEO (QBA) 1-1/4"x1/16"x22" - 7 Ho	56361178	CONVERTAMATIC 18B
86802910/ AD-18-4C	BLADE, NEO (QBA) 1-18"x1/16"x22" - 7 Hole	56361186	CONVERTAMATIC 18B
86802890/ AD-18-4A	BLADE, TAN GUM (QBA) 1-3/8"x1/8"x22" - 7	56361216	CONVERTAMATIC 18B
86618700/ AD-21-CS	SQUEEGEE CARTRIDGE-21	56362892	Convertamatic 21B
86803290/ AD-24-4AN	BLADE, NEO (QBA) 28-1/4" long - 10 Holes	56371092	CONVERTAMATIC 24B
86803510/ AD-26HD-4B	BLADE, NEO (QBA) 1-3/8"x1/8"x31-3/4" -10	56372764	CONVERTAMATIC 26BHD
86803500/ AD-26HD-4A	BLADE, TAN GUM (QBA) 1-1/2"x1/8"x32-1/4"	56372766	CONVERTAMATIC 26BHD
98485830/ AD-26HD-4	SQUEEGEE SET-260BHD (QBA)	56372786	CONVERTAMATIC 26BHD
86619670/ AD-260-FS	SKIRT, FRONT	56372876	Convertamatic 260B
86619670/ AD-260-FS	SKIRT, FRONT	56372876	Hydro-Retriever 260BHD
86619660/ AD-260-RS	SKIRT, REAR	56372920	Convertamatic 260B
86619660/ AD-260-RS	SKIRT, REAR	56372920	Hydro-Retriever 260BHD
86618660/ AD-26-C	CARTRIDGE-SQ.26 56372982	56372982	Convertamatic 260B
86618660/ AD-26-C	CARTRIDGE-SQ.26 56372982	56372982	Hydro-Retriever 240HD
86618660/ AD-26-C	CARTRIDGE-SQ.26 56372982	56372982	Hydro-Retriever 260BHD,
86618660/ AD-26-C	CARTRIDGE-SQ.26 56372982	56372982, 56372992	BA 600
86618660/ AD-26-C	CARTRIDGE-SQ.26 56372982	56372982, 56372992	Convertamatic 240LX



Advance (con't)

GRACO#/Old Graco#	Material Description	Compatible OEM Part Number	Fits Machines
86619630/ AD-280-S	SKIRT 280(56376076)	56376076	TRAC 280
86803620/ AD-280-3A	SQUEEGEE-GUM (QBA)	56376566	TRAC 280
86803640/ AD-280-3C	SQUEEGEE WEAR STRIP (QBA)	56376568	TRAC 280
86658150/ AD-38-C	SQUEEGEE CART 40"	56377378, 56400612	CONVERTAMATIC 38BD
86619760/ AD-380-C	SQUEEGEE CARTRIDGE-380	56377404	Convertamatic 38BD
86619870/ AD-380-4	SQUEEGEE SET 380BHD	56377718	Hydro-Retriever 380BHD
86618650/ AD-20-CS	SQUEEGEE BLADE CARTRIDGE 20"	56382356	Sprite Air Scoop
86619790/ AD-200-S	SPLASHGUARD, 200B	56382905	Convertamatic 200B, E
86619790/ AD-200-S	SPLASHGUARD, 200B	56382905	Convertamatic 200B/LX
86619790/ AD-200-S	SPLASHGUARD, 200B	56382905	Convertamatic 200LX
86619790/ AD-200-S	SPLASHGUARD, 200B	56382905	Convertamatic 20B
86619790/ AD-200-S	SPLASHGUARD, 200B	56382905	Hydro-Retriever 200HD
86802790/ AD-17-4A	BLADE, GUM (QBA) 1-1/4"x1/8"/20-1/4" -6	56384990	CONVERTAMATIC 17B
86802810/ AD-17-4C	BLADE, NEO (QBA) 1-1/8"x1/16"20-1/4" -6	56384994	CONVERTAMATIC 17B
86700150/ AD-17-CS	SQ. CARTRIDGE	56385032	CONVERTAMATIC 17B
86802990/ AD-200-L	BLADE LEFT (QBA)	56388404	WHIRLAMATIC 2000B
86803690/ AD-285-3A	SQUEEGE BLADE, (QBA) ADVANCE, GUM	56391192	Convertamatic 285LX
86803690/ AD-285-3A	SQUEEGE BLADE, (QBA) ADVANCE, GUM	56391192	Hydro-Retriever 285HD
86803690/ AD-285-3A	SQUEEGE BLADE, (QBA) ADVANCE, GUM	56391192	Lynx 285
86803700/ AD-285-3B	SQUEEGEE BLADE, (QBA) ADVANCE, NEO	56391261	Convertamatic 285LX
86803700/ AD-285-3B	SQUEEGEE BLADE, (QBA) ADVANCE, NEO	56391261	Hydro-Retriever 285HD
86803700/ AD-285-3B	SQUEEGEE BLADE, (QBA) ADVANCE, NEO	56391261	Lynx 285
86619780/ AD-320-S	SPLASHGAURD, TRAC 280	56391304	TRAC 320
86619650/ AD-325-SL	SKIRT-L.H.56392097	56392097	Convertamatic 325LX/385LX
86619650/ AD-325-SL	SKIRT-L.H.56392097	56392097	Hydro-Retriever 325HD/385HD
86619650/ AD-325-SL	SKIRT-L.H.56392097	56392097	Lynx 325/385
86619640/ AD-325-SR	SKIRT, R.H.	56392098	Convertamatic 325LX/385LX
86619640/ AD-325-SR	SKIRT,R.H.	56392098	Hydro-Retriever 325HD/385HD
86619640/ AD-325-SR	SKIRT,R.H.	56392098	Lynx 325/385
86803880/ AD-325-3A	BLADE, GUM (QBA) 2-1/2"x3/16"x46-1/8" -	56392739	Convertamatic 325LX / 385LX
86803880/ AD-325-3A	BLADE, GUM (QBA) 2-1/2"x3/16"x46-1/8" -	56392739	Hydro-Retriever 325HD / 385HD
86803880/ AD-325-3A	BLADE, GUM (QBA) 2-1/2"x3/16"x46-1/8" -	56392739	Lynx 325 / 385
86803890/ AD-325-3B	BLADE, NEO (QBA) 2-5/16"x1/8"x45-1/8" -1	56392740	Convertamatic 325LX / 385LX
86803890/ AD-325-3B	BLADE, NEO (QBA) 2-5/16"x1/8"x45-1/8" -1	56392740	Hydro-Retriever 325HD / 385HD
86803890/ AD-325-3B	BLADE, NEO (QBA) 2-5/16"x1/8"x45-1/8" -1	56392740	Lynx 325 / 385
86803900/ AD-325-3C	BLADE, NEO (QBA) 1-3/4"x18"x46" - 8 Hole	56392741	Convertamatic 325LX / 385LX
86803900/ AD-325-3C	BLADE, NEO (QBA) 1-3/4"x18"x46" - 8 Hole	56392741	Hydro-Retriever 325HD / 385HD
86803900/ AD-325-3C	BLADE, NEO (QBA) 1-3/4"x18"x46" - 8 Hole	56392741	Lynx 325 / 385
86802940/ AD-18-SL	SPLASHGUARG (LEFT) (QBA)	56395633	CONVERTAMATIC 18B
86802950/ AD-18-SR	SPLASHGUARD (RIGHT) (QBA)	56395684	CONVERTAMATIC 18B
86618640/ AD-32N-C	CARTRIDGE,32N	56395793	Convertamatic 32B/32BD
98486020/ AD-285R-2	SQUEEGEE BLADE KIT, (QBA) RED	56396172	Convertamatic 285LX
98486020/ ADV56396172 Graco AD-285R-2	SQUEEGEE BLADE KIT, (QBA) RED	56396172	Hydro-Retriever 285HD
98486020/ AD-285R-2	SQUEEGEE BLADE KIT, (QBA) RED	56396172	Lynx 285
86696760	BLADES	56397019	CMAX 28ST
86696760	BLADES	56397019	CMAX 34ST
86696760	BLADES	56397019	I-MAX 28C
86696760	BLADES	56397019	I-MAX 32C
86804090/ AD-34R-2A	BLADE, REAR RED (QBA)	56397091	ConvertaMAX 28
86804090/ AD-34R-2A	BLADE, REAR RED (QBA)	56397091	ConvertaMAX 34

Squeegees



Advance (con't)

GRACO#/Old Graco#	Material Description	Compatible OEM Part Number	Fits Machines
86804090/ AD-34R-2A	BLADE, REAR RED (QBA)	56397091	I-MAX 28HD
86804090/ AD-34R-2A	BLADE, REAR RED (QBA)	56397091	I-MAX 34HD
98485920/ AD-38HD-3	SQUEEGEE SET-38BHD (QBA)	56404095	CONVERTAMATIC 38BHD
86697060/ AD-CYL-S	KIT SCRUB DECK SQUEEGEE	56407447	Adgressor
86697060/ AD-CYL-S	BLADE, SCRUB DECK SQUEEGEE	56407447	Adgressor
86697060/ AD-CYL-S	KIT SCRUB DECK SQUEEGEE	56407447	Advenger
86697060/ AD-CYL-S	KIT SCRUB DECK SQUEEGEE	56407447	Hydro-Retriever 2042
86697060/ AD-CYL-S	KIT SCRUB DECK SQUEEGEE	56407447	Hydro-Retriever 2800
86697060/ AD-CYL-S	KIT SCRUB DECK SQUEEGEE	56407447	Hydro-Retriever 3200
86697060/ AD-CYL-S	KIT SCRUB DECK SQUEEGEE	56407447	Hydro-Retriever 3800
98486030/ AD-3800NG-2	BLADE KIT (QBA)	56407589	HYDRORETRIEVER 3800
86858750/ AD-3800NN-2	BLADE KIT, NEO (QBA)	56407602	Hydro-Retriever 2042
86858750/ AD-3800NN-2	BLADE KIT, NEO (QBA)	56407602	Hydro-Retriever 3200
86858750/ AD-3800NN-2	BLADE KIT, NEO (QBA)	56407602	Hydro-Retriever 3800
86619620/ AD-3800-S	SPLASHGUARD-3800	56409103	Hydro-Retriever 3800
86620000/ AD-3800-2B	SQ. BLADE REAR	56409413	Convertamatic 38LX
86620000/ AD-3800-2B	SQ. BLADE REAR	56409413	ConvertaMAX 28
86620000/ AD-3800-2B	SQ. BLADE REAR	56409413	ConvertaMAX 34
86620000/ AD-3800-2B	SQ. BLADE REAR	56409413	Hydro-Retriever 3800
86620000/ AD-3800-2B	SQ. BLADE REAR	56409413	Hydro-Retriever 380HD
86620000/ AD-3800-2B	SQ. BLADE REAR	56409413	I-MAX 28HD
86620000/ AD-3800-2B	SQ. BLADE REAR	56409413	I-MAX 34HD
98485080/ AD-3800-2	SQUEEGEE SET (QBA) gum	56409429	ConvertaMAX 28
98485080/ AD-3800-2	SQUEEGEE SET (QBA) gum	56409429	ConvertaMAX 34
98485080/ AD-3800-2	SQUEEGEE SET (QBA) gum	56409429	I-MAX 34HD
86713870/ AD-3800-2A	FRONT SQ BLADE	56409627	Convertamatic 38LX
86713870/ AD-3800-2A	FRONT SQ BLADE	56409627	ConvertaMAX 28
86713870/ AD-3800-2A	FRONT SQ BLADE	56409627	ConvertaMAX 34
86713870/ AD-3800-2A	FRONT SQ BLADE	56409627	Hydro-Retriever 3800
86713870/ AD-3800-2A	FRONT SQ BLADE	56409627	Hydro-Retriever 380HD
86713870/ AD-3800-2A	FRONT SQ BLADE	56409627	I-MAX 28HD
86713870/ AD-3800-2A	FRONT SQ BLADE	56409627	I-MAX 34HD
86803600/ AD-2800-2B	FRONT BLADE, (QBA) HYDRO RETRIEVER 2800	56412029	HYDRORETRIEVER 2800
86803590/ AD-2800-2A	REAR BLADE, (QBA) HYDRORETRIEVER 2800	56412030	HYDRORETRIEVER 2800
98485220/ AD-2800-2	SQUEEGEE BLADE SET (QBA)	56412265	HYDRORETRIEVER 2800
98485220/ AD-2800-2	SQUEEGEE BLADE SET (QBA)	56412265	HYDRORETRIEVER 2800
86804350/ AD-5000-4A	BLADE, TAN GUM (QBA) 2-1/2"x1/4"x62" -15	56454209	HydroCat 5015
86804350/ AD-5000-4A	BLADE, TAN GUM (QBA) 2-1/2"x1/4"x62" -15	56454209	Hydro-Retriever 2052
86804350/ AD-5000-4A	BLADE, TAN GUM (QBA) 2-1/2"x1/4"x62" -15	56454209	Hydro-Retriever 5000B
86804350/ AD-5000-4A	BLADE, TAN GUM (QBA) 2-1/2"x1/4"x62" -15	56454209	Hydro-Retriever 5000G/P
86804350/ AD-5000-4A	BLADE, TAN GUM (QBA) 2-1/2"x1/4"x62" -15	56454209	Hydro-Retriever 5010B
86804360/ AD-5000-4B	BLADE, NEO (QBA) 2"x1/8"x60-3/4" -15 Hol	56454215	HydroCat 5015
86804360/ AD-5000-4B	BLADE, NEO (QBA) 2"x1/8"x60-3/4" -15 Hol	56454215	Hydro-Retriever 2052
86804360/ AD-5000-4B	BLADE, NEO (QBA) 2"x1/8"x60-3/4" -15 Hol	56454215	Hydro-Retriever 5000B
86804360/ AD-5000-4B	BLADE, NEO (QBA) 2"x1/8"x60-3/4" -15 Hol	56454215	Hydro-Retriever 5000G/P
86804360/ AD-5000-4B	BLADE, NEO (QBA) 2"x1/8"x60-3/4" -15 Hol	56454215	Hydro-Retriever 5010B
86804380/ AD-5000-4D	BLADE, URETHANE (QBA) 2"x1/4"x56-3/4" -13	56455606	HydroCat 5015
86804380/ AD-5000-4D	BLADE, URETHANE (QBA) 2"x1/4"x56-3/4" -13	56455606	Hydro-Retriever 2052
86804380/ AD-5000-4D	BLADE, URETHANE (QBA) 2"x1/4"x56-3/4" -13	56455606	Hydro-Retriever 5000B
86804380/ AD-5000-4D	BLADE, URETHANE (QBA) 2"x1/4"x56-3/4" -13	56455606	Hydro-Retriever 5000G/P



Advance (con't)

GRACO#/Old Graco#	Material Description	Compatible OEM Part Number	Fits Machines
86804380/ AD-5000-4D	BLADE, URETHANE (QBA) 2"x1/4"x56-3/4" -13	56455606	Hydro-Retriever 5010B
86804370/ AD-5000-4C	BLADE, TAN GUM (QBA) 2-1/4"x3/16"x57-3/4	56455608	HydroCat 5015
86804370/ AD-5000-4C	BLADE, TAN GUM (QBA) 2-1/4"x3/16"x57-3/4	56455608	Hydro-Retriever 2052
86804370/ AD-5000-4C	BLADE, TAN GUM (QBA) 2-1/4"x3/16"x57-3/4	56455608	Hydro-Retriever 5000B
86804370/ AD-5000-4C	BLADE, TAN GUM (QBA) 2-1/4"x3/16"x57-3/4	56455608	Hydro-Retriever 5000G/P
86804370/ AD-5000-4C	BLADE, TAN GUM (QBA) 2-1/4"x3/16"x57-3/4	56455608	Hydro-Retriever 5010B
86619730/ AD-240-2A	SQ,REAR GUM	8602468	Convertanatic 240LX
86803970/ AD-32-CS	SQUEEGEE CARTRIDGE SOFT (QBA)	ADCART-32SFT	CONVERTAMATIC 32B
86638060	REAR BLADE	L08603832	ADVINITY 20D/X20D/X20C/X24D
86638060	REAR BLADE	L08603832	RAZOR
86804490	SKIRT, CYLINDRICAL SCRUB HEAD	56314530	Adgressor
98481950	SKIRT KIT, ADVENGER 32" GUM	56314914	Adgressor
98481950	SKIRT KIT, ADVENGER 32" GUM	56314914	ADVENGER
86618410/ AD-285-SL	SKIRT-L.H.	53691972	Convertamatic 285LX
86618410/ AD-285-SL	SKIRT-L.H.	56391972	Hydro-Retriever 285HD
86618410/ AD-285-SL	SKIRT-L.H.	56391972	Lynx 285
86618420/ AD-285-SR	BLADE. R.H.	56391971	Convertamatic 285LX
86618420/ AD-285-SR	BLADE. R.H.	56391971	Hydro-Retriever 285HD
86618420/ AD-285-SR	BLADE. R.H.	56391971	Lynx 285
86618570	SKIRT RIGHT	56397014	BA 750C
86618570	SKIRT RIGHT	56397014	BA 750ST
86618570	SKIRT RIGHT	56397014	BA 850ST
86618570	SKIRT RIGHT	56397014	CMAX 28ST
86618570	SKIRT RIGHT	56397014	CMAX 34ST
86618570	SKIRT RIGHT	56397014	I-MAX 28C
86618570	SKIRT RIGHT	56397014	I-MAX 32C
86618570	SKIRT RIGHT	56397014	I-MAX 32C
86802830/ AD-17-4NA	BLADE, NEO (QBA) 1-3/8"x1/8"x20-1/4" -6 H		CONVERTAMATIC 17B
86803100/ AD-20-4NNA	BLADE, NEO 1-5/8"x1/8"x24" - 7 Holes		CONVERTAMATIC 20B
86803140/ AD-20-S2	SPLASHGUARD SET (QBA)		CONVERTAMATIC 20B
86803340/ AD-24-S2	SPLASHGUARD SET (QBA)		CONVERTAMATIC 24B
86803460/ AD-26-4N	SQUEEGEE SET (NEO) (QBA)	550952	CONVERTAMATIC 26B
86803480/ AD-26-CS	SQUEEGEE CARTRIDGE SOFT (QBA)	AD-CART26S	CONVERTAMATIC 26B
86803530/ AD-26-S2	SPLASHGUARD SET		CONVERTAMATIC 26B
86803710/ AD-285-3C	SQUEEGEE BLADE, (QBA) NEO, ADVANCE		Convertamatic 285LX
86803710/ AD-285-3C	SQUEEGEE BLADE, (QBA) NEO, ADVANCE		Hydro-Retriever 285HD
86803710/ AD-285-3C	SQUEEGEE BLADE, (QBA) NEO, ADVANCE		Lynx 285
86803760/ AD-285R-2A	BLADE, RED 2-3/4"x1/8"x37"-10 Slots,6HLS		Convertamatic 285LX
86803760/ AD-285R-2A	BLADE, RED 2-3/4"x1/8"x37"-10 Slots,6HLS		Hydro-Retriever 285HD
86803760/ AD-285R-2A	BLADE, RED 2-3/4"x1/8"x37"-10 Slots,6HLS		Lynx 285
86803770/ AD-285-2B	BLADE, RED 2-7/16"x3/16"x39-1/2"-6 HOLES		Convertamatic 285LX
86803770/ AD-285-2B	BLADE, RED 2-7/16"x3/16"x39-1/2"-6 HOLES		Hydro-Retriever 285HD
86803770/ AD-285-2B	BLADE, RED 2-7/16"x3/16"x39-1/2"-6 HOLES		Lynx 285
86803840/ AD-32-4C	BLADE, NEO1-1/8"x1/16"x38-15/16"-12 Hole	56474650	CONVERTAMATIC 32B
86803990/ AD-32N-CS	CARTRIDGE SOFT (QBA)		CONVERTAMATIC 32B
86804170/ AD-380-CS	SQUEEGEE CARTRIDGE SOFT (QBA)		CONVERTAMATIC 38BD
86804240/ AD-38-4NA	BLADE, NEO (QBA) 1-3/8"x1/8"x42-3/4" - 1		CONVERTAMATIC 38BD
86804260/ AD-38-CS	SQUEEGEE CARTRIDGE SOFT (QBA)	ADCART-38OF	CONVERTAMATIC 38BD
86804290/ AD-38N-CS	SQUEEGEE CARTRIDGE SOFT (QBA)		CONVERTAMATIC 38BD
86893640/ AD-26DR-2A	BLADE, REAR 1/4RED 41.5X2.875		CONVERTAMATIC 26D-C

Squeegees



Advance (con't)

GRACO#/Old Graco#	Material Description	Compatible OEM Part Number	Fits Machines
86893650/ AD-26DR-2B	BLADE, FRONT 3/16RED 37X2.875		CONVERTAMATIC 26D-C
86893660/ AD-3800NG-2A	BLADE, REAR 3/8GUM 46.25X3.25		Hydro-Retriever 3800
86893670/ AD-3800NG-2B	BLADE, REAR 3/8GUM 44.75X3.1875		Hydro-Retriever 3800
86893700/ AD-38HD-3A	BLADE, REAR 3/16GUM 44.75X1.5		CONVERTAMATIC 38HD
86893710/ AD-38HD-3B	BLADE, BACKUP 1/8NEO 43X1.25		CONVERTAMATIC 38HD
86893720/ AD-38HD-3C	BLADE, FRONT PLASTIC		CONVERTAMATIC 38HD
86897800/ AD-26D-2A	BLADE,1/4" TAN GUM 41.5"x 2.75" 8HOLES		CONVERTAMATIC 26D-C
86897810/ AD-26D-2B	3/16" TAN GUM 36.75"x 2.625" 10HOLES		CONVERTAMATIC 26D-C
98486040/ AD-26DR-2	KIT, RED SQ BLADE (QBA) 26" & 28"		CONVERTAMATIC 26D-C

American Lincoln

GRACO#/Old Graco#	Material Description	Compatible OEM Part Number	Fits Machines
98486710	SIDE BLADE KIT	56514859	7765
98486630	BLADE KIT,RED,REAR SKIRT SQUEEGEE	56514860	7765
98486640	BLADE KIT, SIDE	56515817	7730
98486650	BLADE KIT, FRONT/REAR	56515818	7730
86805650/ AL-750-S	SPLASHGUARD BLADE (QBA)	7-25-08016	950
86805530/ AL-62-4C	BLADE, TAN GUM (QBA) 4-3/16"x3/8"x26"	7-25-08044	6200
86831440/ C-34V-IE	SKIRT INNER (QBA)	7-25-08062	2000
86805300/ AL-21-2B	BLADE, BLACK (QBA) C.I. 2-1/2"x1/8"x25-1	7-77-00026	721
86805280/ AL-21-2A	BLADE, TAN GUM (QBA) 2-1/2"x1/4"x27" - 6	7-77-00027	721
86805240/ AL-19-2A	BLADE, C.I. NEO (QBA) 2-1/2"x1/8"x21-1/4	7-77-00030	719
86805250/ AL-19-2B	BLADE, C.I. NEO (QBA) 2-1/2"x1/8"x21-1/4	7-77-00031	719
86805450/ AL-560-2AN	BLADE, NEO (QBA) 2-1/2x1/4x34 - 8 Holes	7-77-00033	560
86805680/ AL-772-2B	BLADE, TAN GUM(QBA) 2-1/2"x1/4"x46-1/2"	7-77-00035,	772
86805670/ AL-772-2A	BLADE, TAN GUM (QBA) 2-1/2"x1/4"x46-1/2"	7-77-00036,	772
86805600/ AL-726-2A AL-750-2A	BLADE, TAN GUM (QBA) 2-1/2"x1/4"x30-1/2	7-77-00037	726
86805490/ AL-560-2SB	BLADE, C.I.(QBA) NEO 2-1/2x1/8x32-1/4 -	7-77-00039	560
86805610/ AL-726-2AN	BLADE, NEO (QBA) 2-1/2"x1/4"x30-1/2" - 8	7-77-00043	726
86805800/ AL-950-C	BLADE, NEO (QBA) 2-1/2"x1/8"x30-1/4"-8	7-77-00055	950
86805640/ AL-750-2B	BLADE, BLACK (QBA) C.I. 2-1/2"x1/8"x26-1	7-77-00056,	950
86805550/ AL-70-5A	BLADE, TAN GUM (QBA) 3-1/4x1/4x65 - Stri	7-77-00057	7000
86805570/ AL-70-5C	BLADE, TAN GUM (QBA) 3-1/2x/8x22 - 7 Hol	7-77-00060	7000
86805740/ AL-930-2A	BLADE, TAN GUM (QBA) 2"x3/16"x38-1/2" -N	7-77-00064,	930
86805750/ AL-930-2B	BLADE, NEOPRENE (QBA) 1-5/15"x1/8"x38-3/	7-77-00065,	930
86805720/ AL-77-8D	BLADE, TAN GUM (QBA) 4"x3/8"x33" -8 Hole	7-77-00069	7700
86805730/ AL-77-8E	BLADE, URETHANE (QBA) BACKUP 3-3/4"x1/8"	7-77-00070	7700
86805510/ AL-62-4A	BLADE, TAN GUM (QBA) 2-1/4X1/4X54-1/4 -	7-77-00076	6200
86805520/ AL-62-4B	BLADE, URETHANE (QBA) 2-1/8x1/8x51-1/2-1	7-77-00077	6200
86805770/ AL-934-2A	BLADE, TAN GUM (QBA) 2"x3/16"x38-1/2" -N	7-77-00081,	934
86805260/ AL-1-SP	FLAP	8-25-0807	2000
86805370/ AL-2-SP	FLAP	8-25-08081	2000
86805380/ AL-3-SP	FLAP	8-25-08086	2000
88059960	BLADE,NEO 1/8"x3-1/16"X81-1/4" 48 SLT	7-77-00107	7765
86805310/ AL-225-5	SQUEEGEE SET (QBA) - MODEL 225		225
86805480/ AL-560-2SA	BLADE, NEO (QBA)2-1/2x1/8x32-1/4 - 8 Hol		560
86805500/ Graco AL-62-4	SQUEEGEE SET (QBA)		6200



American Lincoln (con't)

GRACO#/Old Graco#	Material Description	Compatible OEM Part Number	Fits Machines
86805790/ AL-950-5	SQUEEGEE SET (QBA)		950
98485230/ AL-750-2	SQUEEGEE SET (QBA)		950
98485640/ AL-19-2	SQUEEGEE SET (QBA)		719
98485650/ AL-560-2S	SQUEEGEE SET (QBA)		560

Betco

GRACO#/Old Graco#	Material Description	Compatible OEM Part Number	Fits Machines
86639960/ MM-260-3A	REAR SQ. 260263	AS261269	
86639970/ MM-260-3B	REINFORCEMENT BLADE 260264	AS261270	
86639980/ MM-260-3C	FRONT SQ. 260265	AS261273	

Clarke

GRACO#/Old Graco#	Material Description	Compatible OEM Part Number	Fits Machines
86606800/ C-80-3C	BLADE SQ.FRONT (80-3200)	83070	LEADER 3200
86606800/ C-80-3C	BLADE SQ.FRONT (80-3200)	83070	TB80
86639660/ C-80-3B	BLADE-SQUEEGEE BA	83070	LEADER 3200
86639660/ C-80-3B	BLADE-SQUEEGEE BA	83070	TB80
86830920/ C-20T-5	SQUEEGEE SET (QBA)	680705	20" SQUEEGEE TOOL
86830770/ C-14T-5	SQUEEGEE SET	680724	14" SQUEEGEE TOOL
86831140/ C-24-3B	BLADE, NEO (QBA) 2-1/4"x3/16"x30-5/8" -9	800750	TB24
86831150/ C-24-3C	BLADE, BLACK (QBA) C.I. 2-1/8"x1/8"x28"	800751	TB24
86830810/ C-16-3C	BLADE, C.I. (QBA) NEO BACKUP 2-1/8"x1/8"	810780	TB16
86830790/ C-16-3A	BLADE, GUM (QBA) 2-1/2"x3/16"x19-5/8" -	810781	TB16
86830800/ C-16-3B	BLADE, NEO (QBA) 1-1/2"x3/16"x19-5/8" -5	810782	TB16
86830960/ C-21-3B	BLADE, NEO (QBA) 1-5/8"x1/4"x25" - 7 Hol	820720	TB21
86606760/ C-60-3B	BLADE, NEO (QBA) 2-1/8"x3/16"x31" - 9 Ho	830702	LEADER 2400
86606760/ C-60-3B	BLADE, NEO (QBA) 2-1/8"x3/16"x31" - 9 Ho	830702	TB60
86606770/ C-60-3C	BLADE, BLACK (QBA) C.I. 1-1/4"x1/8"x28"	830703	TB60
86831530/ C-42-2A	BLADE, GUM (QBA) 3-1/4"x1/4"x49-1/2" - 1	850741	TB42
86831540/ C-42-2B	BLADE, C.I. (QBA) NEO 2-1/4"x1/8"x49-1/2	850742	TB42
86830970/ C-21-3C	BLADE, BLACK (QBA) C.I. BACKUP 2-3/8"x1/	870760	TB21
86830950/ C-21-3A	BLADE, TAN GUM (QBA) 2-3/4"x3/16"x25" -7	870761	TB21
86830880	BLADE, C.I.2-3/8"x1/8"x20-1/2" -7 Holes	880152	PE20
86830880	BLADE, C.I.2-3/8"x1/8"x20-1/2" -7 Holes	880152	PS20BP
86830880	BLADE, C.I.2-3/8"x1/8"x20-1/2" -7 Holes	880152	TB-18
86830870	BLADE, NEO 2-1/4"x3/16"x23-1/2"-11 Holes	880750	PE20
86830870	BLADE, NEO 2-1/4"x3/16"x23-1/2"-11 Holes	880750	PS20BP
86830870	BLADE, NEO 2-1/4"x3/16"x23-1/2"-11 Holes	880750	TB-18
86830860	BLADE,GUM 2-3/4"x3/16"x23-1/2"-7 Holes	880751	PE20
86830860	BLADE,GUM 2-3/4"x3/16"x23-1/2"-7 Holes	880751	PS20BP
86830860	BLADE,GUM 2-3/4"x3/16"x23-1/2"-7 Holes	880751	TB-18
86831350/ C-32-3C	BLADE, C.I. (QBA) BLACK 2-1/4"x1/8"x35"	890701	TB32
86831330/ C-32-3A	BLADE, TAN GUM (QBA) 2"x3/16"x41-5/16" -	890702	TB32
86831340/ C-32-3B	BLADE, NEO (QBA) 2-1/8"x3/16"x37" -11 Ho	897501	TB32
98486380	SQUEEGEE SET URETHANE 41"	11331A	Focus II Mid Size 34



Clarke (con't)

GRACO#/Old Graco#	Material Description	Compatible OEM Part Number	Fits Machines
98486390	SQUEEGEE SET URETHANE 35"	11332A	Focus II Mid Size 28
98486410	SQUEEGEE SET GUM 41" SQ. TOOL	11334A	Focus II Mid Size 34
98486430	SQUEEGEE SET GUM 35" SQ. TOOL	11335A	Focus II Mid Size 28
98486400	SQUEEGEE SET RED 41" SQ. TOOL	11337A	Focus II Mid Size 34
98486420	SQUEEGEE SET RED 35" SQ. TOOL	11338A	Focus II Mid Size 28
86831070/ C-242632-2B	32" Front Ribbed Blade (QBA) HARD SERRAT	30066A	ENCORE 17/20
86831070/ C-242632-2B	32" Front Ribbed Blade (QBA) HARD SERRAT	30066A	ENCORE 24/26
86831060/ C-242632-2A	32" Gum Rear Blade (QBA)	30067A	ENCORE 17/20
86831060/ C-242632-2A	32" Gum Rear Blade (QBA)	30067A	ENCORE 24/26
86872280	BLADE, OUTER- RED 35.12"	30067L	ENCORE
86831090/ C-242639-2A	39" Gum Rubber (QBA) Rear Blade	30069A	ENCORE 17/20
86831090/ C-242639-2A	39" Gum Rubber (QBA) Rear Blade	30069A	ENCORE 24/26
86831090/ C-242639-2A	39" Gum Rubber (QBA) Rear Blade	30069A	ENCORE S30/L30
86671550/ C-242639-2B	BLADE SQ	30091A	ENCORE 20
86671550/ C-242639-2B	BLADE SQ	30091A	ENCORE 28
86671550/ C-242639-2B	BLADE SQ	30091A	ENCORE 33
86671550/ C-242639-2B	BLADE SQ	30091A	ENCORE 39
86831250/ C-2833F-2A	REAR BLADE,(QBA)28/33 FOR 10803KL	30557L	ENCORE 28
86831260/ C-2833F-2B	FRONT BLADE,QBA)28/33 FOR 10803K	30717L1	ENCORE 28
86671910/ C-33F-2A	SQ BLADE	30717L2	ENCORE 33
86831480/ C-38F-2B	INNER BLADE, 38 FOCUS	30718L2	FOCUS 38
86872290/ C-2829F-2B"	BLADE, INNER, NOTCHED 1/8" RED	30764L1	ENCORE 28
88055490	SQ. BLADE, REAR URETHANE 41" TOOL	30814U	Focus II Mid Size 34
88055510	SQ. BLADE, REAR URETHANE 35" TOOL	30815U	Focus II Mid Size 28
88055520	SQ. BLADE, FRONT URETHANE 35" TOOL	30818U	Focus II Mid Size 28
88055500	SQ. BLADE, FRONT URETHANE 41" TOOL	30819U	Focus II Mid Size 34
86608200/ C-2000-2A	BLADE, TAN GUM (QBA) 2-3/8"x1/8"x29" -9	30902A	LEADER 2000
86608200/ C-2000-2A	BLADE, TAN GUM (QBA) 2-3/8"x1/8"x29" -9	30902A	VISION 17
86608210/ C-2000-2B	BLADE, TAN GUM (QBA) 2-5/16"x1/8"x29" -9	30903A	LEADER 2000
86608210/ C-2000-2B	BLADE, TAN GUM (QBA) 2-5/16"x1/8"x29" -9	30903A	VISION 17
86605430/ C-26V-2A	BLADE, TAN GUM (QBA) 2"x3/16"x38-1/2" -N	30912A	ENCORE 28
86605430/ C-26V-2A	BLADE, TAN GUM (QBA) 2"x3/16"x38-1/2" -N	30912A	VISION 26
86831280/ C-28F-2A	REAR BLADE, (QBA) , 28 FOCUS	30912L	ENCORE
86605450/ C-32V-2A	BLADE, TAN GUM (QBA) 2"x3/16"x41-5/16" -	30913A	ENCORE 33
86605450/ C-32V-2A	BLADE, TAN GUM (QBA) 2"x3/16"x41-5/16" -	30913A	VISION 32
86671930/ C-33F-2B	SQUEEGEE BLADE	30913L	ENCORE 33
86605440/ C-26V-2B	BLADE, NEO (QBA) 1-7/8"x1/8"x35-7/8"-8 No	30914A,	ENCORE 28
86605440/ C-26V-2B	BLADE, NEO (QBA) 1-7/8"x1/8"x35-7/8"-8 No	30914A,	VISION 26
86605460/ C-32V-2B	BLADE, NEO (QBA) 1-7/8"x1/8"x39-3/4" -12	30915A	ENCORE 33
86605460/ C-32V-2B	BLADE, NEO (QBA) 1-7/8"x1/8"x39-3/4" -12	30915A	VISION 32
86606070/ C-24-3A	BLADE, TAN GUM (QBA) 30-3/4" Long - 9 Ho	30922A	TB24
86606780/ C-80-3A	BLADE, TAN GUM (QBA) 2-1/2"x1/4"x37"- 17	30923A	LEADER 3200
86606780/ C-80-3A	BLADE, TAN GUM (QBA) 2-1/2"x1/4"x37"- 17	30923A	TB80
86606750/ C-60-3A	BLADE, TAN GUM (QBA) 30-1/2" Lo	30924A	TB60
86606750/ C-60-3A	BLADE, TAN GUM (QBA) 30-1/2" Lo	30924A,	LEADER 2400
86831000/ C-21V-2B	BLADE, NEO (QBA) 1-15/16"x1/8"x25-7/8" -	30930A	ENCORE 17
86831000/ C-21V-2B	BLADE, NEO (QBA) 1-15/16"x1/8"x25-7/8" -	30930A	VISION 21
86830990/ C-21V-2A	BLADE, TAN GUM (QBA) 2"x3/16"x28" Strip	30931A	ENCORE 17
86830990/ C-21V-2A	BLADE, TAN GUM (QBA) 2"x3/16"x28" Strip	30931A	VISION 21
86831220/ C-2829F-2A	REAR BLADE, (QBA) 28/29" FOCUS	"30931L	ENCORE 28



Clarke (con't)

GRACO#/Old Graco#	Material Description	Compatible OEM Part Number	Fits Machines
86605840/ C-38V-2B	BLADE, NEO (QBA) 1-7/8"x1/8"x45-1/2" -No	30934A	ENCORE 38
86605840/ C-38V-2B	BLADE, NEO (QBA) 1-7/8"x1/8"x45-1/2" -No	30934A	VISION 38
86605850/ C-38V-2A	BLADE, GUM (QBA) 2-1/8"x3/16"x48" - No H	30935A	ENCORE 38
86605850/ C-38V-2A	BLADE, GUM (QBA) 2-1/8"x3/16"x48" - No H	30935A	VISION 38
86831470/ C-38F-2A	OUTER BLADE, 38 FOCUS	30935L	FOCUS 38
86605810/ C-20EL-2A	BLADE, TAN GUM (QBA) 2"x3/16"x32-1/2"	30946A,	ENCORE 20E
86605810/ C-20EL-2A	BLADE, TAN GUM (QBA) 2"x3/16"x32-1/2"	30946A,	ENCORE 20E
86605810/ C-20EL-2A	BLADE, TAN GUM (QBA) 2"x3/16"x32-1/2"	30946A,	VISION 21
86605810/ C-20EL-2A	BLADE, TAN GUM (QBA) 2"x3/16"x32-1/2"	30946A,	VISION 21
86605810/ C-20EL-2A	BLADE, TAN GUM (QBA) 2"x3/16"x32-1/2"	30946A,	VISION V
86605810/ C-20EL-2A	BLADE, TAN GUM (QBA) 2"x3/16"x32-1/2"	30946A,	VISION V
86830890/ C-20E-2B	BLADE, RIDGED URETHANE (QBA) 2"x1/8"x26"	30951A	ENCORE
86605700/ C-26V-SL	SKIRT-L.H.38222A	38222A	VISION 26
86605710/ C-26V-SR	SKIRT-R.H.38223A	38223A	VISION 26
86605730/ C-32V-SR	SKIRT-R.H.38224A	38224A	VISION 32
86605720/ C-32V-SL	SKIRT-L.H.38225A	38225A	VISION 32
86605650/ C-21V-SR	SKIRT,R.H.V21,38235A	38235A	VISION 21
86605650/ C-21V-SR	SKIRT,R.H.V21,38235A	38235A	VISION V
86605660/ C-21V-SL	SKIRT,L.H.V21,38236A	38236A	VISION 21
86605660/ C-21V-SL	SKIRT,L.H.V21,38236A	38236A	VISION V
86831040/ C-2400-3C	BLADE, (QBA) Ridged Urethane 1-5/8"x1/8"	830707,	LEADER 2400
86831310/ C-3200-3C	BLADE, (QBA) Ridged Urethane 1-5/8"x1/8"	830708,	LEADER 3200
86830760/ C-14-5B	SQUEEGEE BLADE		14" SQUEEGEE TOOL
86830930/ C-20T-5B	SQUEEGEE BLADE (QBA)		20" SQUEEGEE TOOL
86874760/ C-28F-2B	FRONT BLADE		ENCORE
86894810/ C-32V-2AR	BLADE, REAR (C-32V-2A IN RED)		ENCORE 33
86894810/ C-32V-2AR	BLADE, REAR (C-32V-2A IN RED)		VISION 32
86894820/ C-32V-2BR	BLADE,FRONT RED (C-32V-2A RED)		ENCORE 33
86894820/ C-32V-2BR	BLADE,FRONT RED (C-32V-2A RED)		VISION 32
88057400	BLADE, SQ, REAR RED 41"TOOL		Focus II Mid Size 34
88057410	BLADE, SQ, FRONT RED 41"TOOL		Focus II Mid Size 34
88057420	BLADE, SQ, REAR GUM 41"TOOL		Focus II Mid Size 34
88057430	BLADE, SQ, FRONT GUM 41"TOOL		Focus II Mid Size 34
88057440	BLADE, SQ, REAR RED 35"TOOL		Focus II Mid Size 28
88057450	BLADE, SQ, FRONT RED 35"TOOL		Focus II Mid Size 28
88057460	BLADE, SQ, REAR GUM 35"TOOL		Focus II Mid Size 28
88057470	BLADE, SQ, FRONT GUM 35"TOOL		Focus II Mid Size 28
98484910/ C-32-3	SQUEEGEE SET (QBA)		TB32
98484930/ C-32V-2	SQUEEGEE SET (QBA)		ENCORE 33
98484930/ C-32V-2	SQUEEGEE SET (QBA)		VISION 32
98484940/ C-26V-2	SQUEEGEE SET (QBA)		ENCORE 28
98484940/ C-26V-2	SQUEEGEE SET (QBA)		VISION 26
98484950/ C-21V-2	SQUEEGEE SET (QBA)		VISION 21
98484960/ C-38V-2	SQUEEGEE SET (QBA)		VISION 38
98484970/ C-242632-2	BLADE,SET 2426 32" (QBA)		ENCORE 24/26
98484980/ C-24-3	SQUEEGEE SET (QBA)		TB24
98484990/ C-80-3	SQUEEGEE SET (QBA)		TB80
98485000/ C-60-3	SQUEEGEE SET (QBA)		TB60
98485260/ C-2000-2	SQUEEGEE ST (QBA)		LEADER 2000
98485460/ C-21-3	SQUEEGEE SET (QBA)		TB21

Squeegees



Clarke (con't)

GRACO#/Old Graco#	Material Description	Compatible OEM Part Number	Fits Machines
98485670/ C-42-2	SQUEEGEE SET (QBA)		TB42
98485760/ C-242639-2	BLADE,SET 2426 (QBA) 39"		ENCORE 20
98485760/ C-242639-2	BLADE,SET 2426 (QBA) 39"		ENCORE 28
98485760/ C-242639-2	BLADE,SET 2426 (QBA) 39"		ENCORE 33
98485760/ C-242639-2	BLADE,SET 2426 (QBA) 39"		ENCORE 39
98485770/ C-33F-2	BLADE SET, (QBA) 33 FOCUS		ENCORE 33
98485790/ C-3200-3	SQUEEGEE SET (QBA)		LEADER 3200
98485800/ C-2400-3	SQUEEGEE SET (QBA)		LEADER 2400
98485930/ C-20-3	SQUEEGEE SET (QBA)		TB20
98486060/ C-32V-2R	SQUEEGEE SET 32 (C-32V-2 IN RED)		ENCORE 33
98486060/ C-32V-2R	SQUEEGEE SET 32 (C-32V-2 IN RED)		VISION 32
98486150/ C-2829F-2	SQUEEGEE SET C-2829F-2		ENCORE 28

Eagle Power

GRACO#/Old Graco#	Material Description	Compatible OEM Part Number	Fits Machines
86657270/ E-20-2A	BLADE REAR	MPVR45195, SL03518	EAGLE 20
86722700/ E-2832-2B	SQUEEGEE BLADES	SL03564	FORMAN 28/32
86657260/ E-20-2B	BLADE FRONT	MPVR45194, SL03517	EAGLE 20
86722690/ E-2832-2A	SQUEEGEE BLADES	SL03563	FORMAN 28/32
98485210/ E-20-2	SQUEEGEE SET, EAGLE SK20		EAGLE 20
98485570/ E-2832-2	Squeegee Set for Eagle Panther 28/32		PANTER 28/32

Factory Cat

GRACO#/Old Graco#	Material Description	Compatible OEM Part Number	Fits Machines
88062400	Squeegee Blade,Rear,Gum Fits 32" Sq. Assy.	22-754G	32" Sq. Assy.
88062410	Squeegee Blade,Rear,Gum Thin,Fits 32" Sq. Assy.	22-754GT	32" Sq. Assy.
88062420	Squeegee Blade,Rear, Red, Fits 32" Sq. Assy.	22-754L	32" Sq. Assy.
88062430	Squeegee Blade,Front,Gum Fits 32" Sq. Assy.	22-755G	32" Sq. Assy.
88062440	Squeegee Blade,Front,Gum Thin,Fits 32" Sq. Assy.	22-755GT	32" Sq. Assy.
88062450	Squeegee Blade,Front, Red Fits 32" Sq. Assy.	22-755L	32" Sq. Assy.
88062470	Squeegee Blade,Rear,Gum Fits 35" Sq. Assy.	25-754G	MAGNUM
88062480	Squeegee Blade,Rear,Gum Thin,Fits 35" Sq. Assy.	25-754GT	MAGNUM
88062490	Squeegee Blade,Rear,Red Fits 35" Sq. Assy.	25-754L	MAGNUM
88062530	Squeegee Blade,Front,Gum Fits 35" Sq. Assy.	25-755G	MAGNUM
88062540	Squeegee Blade,Front,Gum Thin,Fits 35" Sq. Assy.	25-755GT	MINIMAG
88062550	Squeegee Blade,Front,Red Fits 35" Sq. Assy.	25-755L	35" Sq. Assy.
88062560	Squeegee Blade,Rear,Gum Fits 38" Sq. Assy.	28-754G	35" Sq. Assy.
88062570	Squeegee Blade,Rear,Gum Thin,Fits 38" Sq. Assy.	28-754GT	35" Sq. Assy.
88062580	Squeegee Blade,Rear, Red Fits 38" Sq. Assy.	28-754L	35" Sq. Assy.
88062600	Squeegee Blade,Front,Gum Fits 38" Sq. Assy.	28-755G	35" Sq. Assy.
88062610	Squeegee Blade,Front,Gum Fits 38" Sq. Assy.	28-755GT	35" Sq. Assy.
88062620	Squeegee Blade,Front, Red Fits 38" Sq. Assy.	28-755L	38" Sq. Assy.
88062640	Squeegee Blade,Front,Gum Fits 45" Sq. Assy.	290-756G	38" Sq. Assy.
88062650	Squeegee Blade,Front, Red Fits 45" Sq. Assy.	290-756L	38" Sq. Assy.
88062670	Squeegee Blade,Rear,Gum Fits 45" Sq. Assy.	7-753G	38" Sq. Assy.



Factory Cat (con't)

GRACO#/Old Graco#	Material Description	Compatible OEM Part Number	Fits Machines
88062680	Squeegee Blade,Rear, Red Fits 45" Sq. Assy.	7-753L	38" Sq. Assy.
88062690	Wiper,Cylindrical	253-9010L	38" Sq. Assy.
88062690	Wiper,Cylindrical	253-9010L	45" Sq. Assy.
88062710	CURTAIN, JAW 13"	253-1320	45" Sq. Assy.
88062720	CURTAIN, JAW 15"	253-1520	45" Sq. Assy.
88062730	CURTAIN, JAW 17"	253-1720	45" Sq. Assy.
98485470/ F-35-2	SQ. SET FACTORY CAT 35	F-35-235	

GRACO

GRACO#/Old Graco#	Material Description	Compatible OEM Part Number	Fits Machines
86840130/ F755160 G-24-3B, G-24-5B	BLADE, TAN GUM (QBA) 3"x1/4"x31-5/16" -	F755160	SATURN 242
86840140/ F755161, G-24-3C, G-24-5C, G-24-5D	BLADE, NEO (QBA) 1-3/4"x3/16"x31-1/2" - 6	F755161	SATURN 243
86840190/ F755162, G-32-3C, G-32-5C, G-32-5D"	BLADE, NEO (QBA) 1-3/4"x3/16"x37-1/2" -	F755162	SATURN 323
86840150/ F755163, G-32-3A, G-32-5A	BLADE, TAN GUM (QBA) 2"x1/8"x33-3/4" - 1	F755163	SATURN 323
86840180/ F755164, G-32-3B	BLADE, GUM (QBA) 3"x1/4"x38-3/8" - 10 Ho	F755164	SATURN 324
98485010/ G-32-3	SQUEEGEE BLADE SET (QBA)	G-32-3	SATURN 326

Hoover

GRACO#/Old Graco#	Material Description	Compatible OEM Part Number	Fits Machines
86841330/ HV-6075-3C	SQUEEGEE - FRONT-26	39512003	6075
86841310/ HV-6075-3A	SQUEEGEE - REAR GUM-26	39512004	6075
86841320/ HV 39512005 Graco HV-6075-3B	SQUEEGEE - REAR BACK UP-26	39512005	6075
86841340/ HV-6075-S	SPLASH GUARD	59187110,	6075

Kent

GRACO#/Old Graco#	Material Description	Compatible OEM Part Number	Fits Machines
86841410/ K-171-1	BLADE, TAN GUM 4-3/4"x1/8"x29" - 5 Hls/1	5603664	KA-171
86841770/ K-27-3B	BLADE, NEO BACKUP 1-3/4"x1/8"x36-13/16"	5605642	SelectScrub 27
86841780/ K-27-3C	BLADE, NEO 2-3/16"x1/8"x35-7/8" - 8 Hls,9	5605642	SelectScrub 27
86842080/ K-39-3A	BLADE, TAN GUM 50" Long - 10 Holes (rear	5605663	SelectScrub 39
86842250/ KM-20-3A	BLADE, TAN GUM 1-7/8"x1/4"x24-3/4"x - 9	56024263	KM-20
86842260/ KM-20-3B	BLADE, TAN GUM 1-5/8"x1/4"x22" - 9 Holes	56024264	KM-20
86842270/ Kent56024265 Graco KM-20-3C"	BLADE, NEO 1-5/8"x1/4"x24-1/4" - 9 Holes	56024265	KM-20
86841560/ K-260-5	SQUEEGEE SET	56038422	K-260
98485940/ K-320-5	SQUEEGEE SET	56038423	320
98485950/ K-381-3	SQUEEGEE SET	56039204	381



Kent (con't)

GRACO#/Old Graco#	Material Description	Compatible OEM Part Number	Fits Machines
98485960/ K-39-3	SQUEEGEE SET	56039567	SS39
86841440/ K-18-4C	BLADE, GUM 1-1/2"x1/4"x9-3/8" - 5 Holes	56046834	K-18
86841430/ K-18-4A	BLADE, GUM 2"x3/16"x24" -13 Holes	56046835	K-18
86841450/ K-18-4D	BLADE, GUM 1-1/2"x1/8"x4" - 2 Holes	56046836	K-18
86841520/ K-20-4C	BLADE, TAN GUM 2"x1/4"x10-1/2" - 5 Holes	56047599	K-20
86841530/ K-20-4D	BLADE, TAN GUM 2"x1/4"x3-1/2" - 2 Holes	56047601	K-20
86841510/ K-20-4A	BLADE, TAN GUM 2-1/8"x1/4"x25-1/2" - 13	56047602	K-20
86841650/ K-26-5D	SQUEEGEE BLADE (GUM)	56048165	26
86841810	SQUEEGEE BLADE (GUM)	56048168	325
86841810	SQUEEGEE BLADE (GUM)	56048168	326
86841570/ K-260-5A	BLADE, TAN GUM 2-1/8"x3/16"x32-3/4" - 16	56048525	260
86841630/ K-26-5A	BLADE, TAN GUM 2-1/8"x3/16"x32-3/4" - 16	56048525	26
86841590/ K-260-5C	BLADE, TAN GUM 2"x1/4"x-11" - 6 Holes	56048527	260
86841580/ K-260-5B	BLADE, NEO 1-1/2"x1/4"x32-3/4" -16 Holes	56049909	260
86841820	BLADE, NEO 1-1/2"x1/4"x39-1/2"-20 Holes	56049910	325
86841820	BLADE, NEO 1-1/2"x1/4"x39-1/2"-20 Holes	56049910	326
86841910/ K-326-2B	BLADE, TAN GUM 2-1/8"x3/16"x41-1/2" - 10	56053777	326
86841900/ K-326-2A	BLADE, TAN GUM 2-1/8"x3/16"x43" - 22 Hol	56053778	326
86841680/ K-266-2B	BLADE, TAN GUM 1-3/4"x1/8"x32-3/4" -13 N	56053807	266
86841670/ K-266-2A	BLADE, TAN GUM 2-1/8"x3/16"x35-3/8" -18	56053808	266
86842040/ K-381-3A	BLADE, TAN GUM 2-3/4"x3/16"x50-1/2" - 10	56054687	381
86842060/ K-381-3C	BLADE, TAN GUM 1-3/4"x1/8"x47" -17 Slots	56054688	381
86841490/ K-201-3C	BLADE, TAN GUM 1-3/4"x1/8"x27-3/4" -8 Slo	56054793	SelectScrub 20/26
86841470/ K-201-3A	BLADE, TAN GUM 2-3/4"x3/16"x30-1/8" -8 H	56054794	SelectScrub 20/26
86841480/ K-201-3B	BLADE, NEO 1-3/4"x1/8"x28-3/4" - 8 Holes	56054795	SelectScrub 20/26
86841760/ K-27-2A K-27-3A	BLADE, TAN GUM 2-1/4"x3/16"x36-3/4" -8 H	56056427	SelectScrub 27
86841990/ K-33-3C	BLADE, NEO BACKUP 2-3/16"x1/8"x42-7/32"	56056428	SelectScrub 33
86841970/ K-33-3A	BLADE, TAN GUM 2-1/4"x3/16"x43-3/16" - 8	56056429	SelectScrub 33
86841980/ K-33-3B	BLADE, NEO BACKUP 1-3/4"x1/8"x36-13/16"	56056430	SelectScrub 33
86842100/ K-39-2B, K-39-3C	BLADE, NEO 2-1/8"x1/8"x48-3/4"-10 Hls,11	56056632	SelectScrub 39
98484750/ K-266-2	SQUEEGEE SET	560202642	266
98484770/ K-266N-3	SQUEEGEE SET	56039065	266
98484790/ K-326N-3	SQUEEGEE SET-NEW	56039066	326
98484760/ K-201-3	SQUEEGEE BLADE SET	56039139	301
98484740/ K-33-3	SQUEEGEE SET	56039566	33
98484780/ K-27-3	SQUEEGEE SET	56039590	SS27
86841800/ K-320-5A"	SQUEEGEE BLADE (GUM)	56048168	K-320
86841740/ K-266N-3C	BLADE, TAN GUM 1-3/4"x1/8"x32-3/4" -13 Nt	56054557	266
86656500/ K-266N-3A	RUBBER SQUEEGEE	56054558	SelectScrub 20/26
86841730/ K-266N-2B, K-266N-3B	BLADE, NEO BACKUP 1-3/4"x1/8"x34-5/15"	56054559	266
86841940/ K-326N-3B	BLADE, TAN GUM BACKUP 1-3/4"x1/8"x40-3/8	56054562	326 NEW
86841930/ K-326N-3A	BLADE, TAN GUM 2-3/4"x3/16"x40-3/8" - 8	56054563	326 NEW
86841950/ K-326N-3C	BLADE, NEO 1-3/4"x1"x41-3/4" - 8 Holes (56054564	326 NEW
86842050/ K-381-3B"	BLADE, NEO 1-3/4"x1/8"x49-1/2"-10 HOLES	56054686	381
86842090/ K-39-3B"	BLADE, NEO 1-3/4"x1/8"x49-1/2" 10 HOLES	56056635	SELECT SCRUB 39
86841390/ K-14T-4A	BLADE, NEO 1-1/4"x1/8"x28" - 7 Holes	K-14T-4A	14" SQUEEGEE TOOL
86841540/ K-20-4NA	SQUEEGEE BLADE (GUM)	K-20-4NA	K-20
86841550/ K-20E-S2	SPLASHGUARD SET	K-20E-S2	K-20



Kent (con't)

GRACO#/Old Graco#	Material Description	Compatible OEM Part Number	Fits Machines
86841610/ K-262B-S	SPLASH GUARD (054232)	K-262B-S	K-262
86841700	K-266N-2A	SQUEEGEE-REAR	K-266N-2A K-266
86841850	K-32-5	SQUEEGEE SET	K-32-5 326

Minuteman

GRACO#/Old Graco#	Material Description	Compatible OEM Part Number	Fits Machines
86841140	BLADE, GUM 1-1/2"x1/8"x33" - 15 Holes	260107	26B
86841150	BLADE,GUM 1-7/8"x3/16"x31-1/2"14 Hls	260108	26B
98485810/ HMC-26-3	SQUEEGEE SET	260120	260
88050000	BLADE SQUEEGEE, GUM FRONT	260242	200X
88050000	BLADE SQUEEGEE, GUM FRONT	260242	240X
88050010	BLADE SQUEEGEE, GUM REAR	260243	200X
88050010	BLADE SQUEEGEE, GUM REAR	260243	240X
86749660	SKIRT, GUM FOR 28-32" MM	281613	ES260
86732600	SQ BLADE MM-ES260-2B	281785	ES260
86732600	SQ BLADE MM-ES260-2B	281785	ES320
86732610	SQ BLADE,REAR MM-ES260-2A	281786	ES260
86732610	SQ BLADE,REAR MM-ES260-2A	281786	ES320
86848060/ PB-90-F	FLAP	300195	TSS90
86848030/ PB-90-3B	BACK-UP BLADE TSS-90	300334	TSS90
86848040/ PB-90-3C	FRONT SQUEEGEE BLADE TSS-90	300553	TSS90
86634810/ HK-170-1	SQUEEGEE BLADE- GUM	430077	170
86843330/ MC-24-3C	BLADE, TAN GUM 2"x1/4"x31" - 13 Holes	809393	24B
86843160/ MC-21-3A	BLADE, GUM 2"x1/4"x28-3/4" - 13 Holes	809395	MULTICLEAN 21
86843170/ MC-21-3B	BLADE, GUM 1-1/2"x1/8"x29"	809397	MULTICLEAN 21
86843480/ MC-32-3B	BLADE, TAN GUM 1-1/2"x1/8"x40" -15 Holes	809528	32B
86843470/ MC-32-3A	BLADE, TAN GUM 1-7/8"x3/16"x37-3/8" -14	809532	32B
86843860/ MM-200-2A	REAR SQUEEGEE BLADE 36" (QBA)	210352	200
86843870/ MM-200-2B	FRONT SQUEEGEE BLADE (QBA)	210354	200
86841130/ HMC-26-3A	BLADE, GUM 2"x3/16"x33" - 15 Holes	260109	26B
86639960/ MM-260-3A	REAR SQ. 260263	260263	260
86639970/ MM-260-3B	REINFORCEMENT BLADE 260264	260264	260
86639970/ MM-260-3B	REINFORCEMENT BLADE 260264	260264	240X
86639980/ MM-260-3C	FRONT SQ.260265	260265	260
98486010/ MM-ES260-2	SQUEEGEE SET, 32" GUM ES260 & ES320	281789	ES260
86696880/ MM-320HD-2BSQ	BLADE FRONT	320014	320HD
86696890/ MM-320HD-2ASQ	BLADE REAR	320015	320HD
86620620/ MM-320R-2B	SQ. FRONT 320 RED	320016	320
86843990/ MM-320R-2A	SQUEEGEE BLADE, (QBA) REAR RED FOR 3	320017	320
98485600/ MM-320R-2	Squeegee Set, (QBA) RED FOR 320* (New Style)	320018	320
98485120/ MM-320HD-2	Squeegee Set, (QBA) GUM FOR 320* (New Style)	320019	320
86620600/ HMC-320-3C	SQUEEGEE,REAR	320194	320
86640060/ HMC-320-3B	REINFORCMENT BLADE 320195	320195	320
86620590/ HMC-320-3A	SQUEEGEE, FRONT	320196	320
86672360/ HMC-320R-3C	FRONT BLADE	320261	320
86672370/ HMC-320R-3A	REAR BLADE	320262	320
86672380/ HMC-320R-3	RED GUM SQUEEGEE SET	320263	320
86843940/ MM-2832-2B	SQ BLADE	320950	ES2832



Minuteman (con't)

GRACO#/Old Graco#	Material Description	Compatible OEM Part Number	Fits Machines
86843930/ MM-2832-2A	SQ BLADE REAR	320951	ES2832
86841110/ HMC-24-3C	BLADE, GUM 1-7/8"x3/16"x29-1/2" -12 Hls,	831472	MULTICLEAN 24
86693600/ HMC-32-3C	SQUEEGEE	831473	32B
86841240/ HMC-32-3AN	BLADE, NEO 2"x3/16"x39-3/4" -15 Holes	833842	32B
86841270/ HMC-32-3CN	BLADE, NEO 1-7/8"x3/16"x37-1/2"-14 Hls,1	833847	32B
86841060/ HK-50-B	BLADE, NEO 1-3/16"x1/8"x39-3/4" - 11 Hol	94-071	MULTICLEAN 50
86841050/ HK-50-A	BLADE, GUM 1-1/2"x1/8"x36-1/2" - 11 Hole	94-072	MULTICLEAN 50
86841070/ HK-50-C	BLADE, NEO 1-1/4"x1/8"x28-3/4" - 11 Hole	94-073	MULTICLEAN 50
86841080/ HK-50-D	BLADE, NEO 1-1/16"x1/16"x28-1/2" - 11 Hol	94-074	MULTICLEAN 50
86843180/ MC-21-3C	BLADE, C.I. 1-1/2"x1/8"x27-1/4" - 12 Hol		MULTICLEAN 21
86843200/ MC-22-2A	BLADE, GUM 1-1/4"x3/16"x30" - 13 Holes		MULTICLEAN 22
86843210/ MC-22-2B	BLADE, GUM 1-1/4"x1/8"x27-1/4" - 12 Holes		MULTICLEAN 22
86843310/ MC-24-3A	BLADE, TAN GUM 1-7/8"x3/16"x29-1/2" - 12		24B
86843320/ MC-24-3B	BLADE, TAN GUM 1-1/2"x1/8"x31" - 13 Hole		24B
86843460/ MC-32-3	SQUEEGEE SET		32B
86848050/ PB-90-8C	FRONT BLADE TSS-90 RED RED RUBBER		TSS90
86893680/ HMC-32-3A	BLADE, REAR 3/16 GUM 40X2		MULTICLEAN 32
86893690/ HMC-32-3B	BLADE, BACKUP 1/8GUN 39.5X1.5		MULTICLEAN 32
88052760/ MM-2832-2RA	BLADE, REAR RED		ES2832
98485100/ MM-260-3	BLADE SET 260 (QBA)		260
98485110/ MM-200-2	SQUEEGEE SET MM200 (QBA)		200
98485500/ NA	ES2832 SQUEEGEE SET, (QBA) GUM RUBBER		MINUTEMAN ES2832
98485740/ HMC-320-3	BLADE SET 320		320
98485840/ HMC-32-3	SQUEEGEE SET		320
98486230/ MM-2832-2	SQUEEGEE SET MM-2832-2R		ES2832

NSS

GRACO#/Old Graco#	Material Description	Compatible OEM Part Number	Fits Machines
86603120/ NSS-33-S"	SPLASHGUARD-33	2693151	WRANGLER 33
86602700/ NSS-27-S	SIDE WIPER-NSS	2790671	WRANGLER 27
86714740/ NSS-26V-2A	BLADE SQUEEGEE	2492401	WRANGLER 26VS
86713970/ NSS-26V-2B	FRONT BLADE	24-9-252-1	WRANGLER 26VS
86845210/ NSS-26-2A	SQUEEGEE BLADE, 33" (QBA) CURVED FRT	2493861	WRANGLER 26
86845220/ NSS-26-2B	SQUEEGEE BLADE, NEOPRENE (QBA)	2493871	WRANGLER 26
86670310/ NSS-33L-2A	REAR SQUEEGEE	2691001, NSS 2693831	CHAMP 3329
86670310/ NSS-33L-2A	REAR SQUEEGEE	2691001, NSS 2693831	CHAMP 3529
86859820	BLADE, 3/16 GUM 2-1/8 x 43-1/4	2692831	WRANGLER 2730
86859820	BLADE, 3/16 GUM 2-1/8 x 43-1/4	2692831	WRANGLER 3330
86603110/ NSS-33-WS	WIPER,SIDE-33	2693141	WRANGLER 33
86845370/ NSS-33C-2B	BLADE-FRONT, CURVED 43" (QBA) (NEO)	2693681	WRANGLER 27 CURVED
86845370/ NSS-33C-2B	BLADE-FRONT, CURVED 43" (QBA) (NEO)	2693681	WRANGLER 33 CURVED
86845360/ NSS-33C-2A	BLADE-REAR, CURVED (QBA) 43" (TAN GUM)	2693691	WRANGLER 27 CURVED
86845360/ NSS-33C-2A	BLADE-REAR, CURVED (QBA) 43" (TAN GUM)	2693691	WRANGLER 33 CURVED
86897850/ NSS-33L-2B	BLADE FRONT 33 CURVED	2693821	CHAMP 3329
86897850/ NSS-33L-2B	BLADE FRONT 33 CURVED	2693821	CHAMP 3529
98481050/ NSS-27-2	(k) Squeegee Set-27 (QBA) (STRAIGHT),	2791061	WRANGLER 26VS
98481050/ NSS-27-2	(k) Squeegee Set-27 (QBA) (STRAIGHT),	2791061	WRANGLER 27 STRAIGHT
86845030/ NSS-14T-5	SQUEEGEE SET	3092199	14"SQUEEGEE TOOL



NSS (con't)

GRACO#/Old Graco#	Material Description	Compatible OEM Part Number	Fits Machines
86845120/ NSS-18T-5	SQUEEGEE SET (QBA)	3092259	18" SQUEEGEE TOOL
98481060/ NSS-33-2	Squeegee Set-33 (QBA) (Straight) 38"	3390261,	WRANGLER 33 STRAIGHT
86858730/ NSS-3330-S	WIPER (QBA)	3392431	WRANGLER 3330
86845160/ NSS-2026-3A	SQUEEGEE BLADE (GUM)		2026
86845170/ NSS-2026-3B	SQUEEGEE BLADE (GUM)		2026
86845180/ NSS-2026-3C	SQUEEGEE BLADE (GUM)		2026
86845190/ NSS-20-3C	SQUEEGEE BLADE(C.I.) (QBA)		20
88051320/ NSS-26VR-2A	BLADE,SQ.REAR RED		26VS
88051590/ NSS-26VR-2B	BLADE,SQ.FRONT RED		26VS
88052250	Squeegee Blade, Red, 1/4 x 2 - 1/8 x 39 NSS	7693371	NSS Champ
88052270	Squeegee Blade, Red 1/4x2-1/8x46-5/8 NSS	7693381	NSS Champ
98484850/ NSS-33C-2	CURVED SQUEEGEE SET (QBA)		WRANGLER 27 CURVED
98484850/ NSS-33C-2	CURVED SQUEEGEE SET (QBA)		WRANGLER 33 CURVED
98484860/ NSS-26-2	SQUEEGEE BLADE SET (QBA) CURVED		WRANGLER 26
98485270/ NSS-33L-2	SQUEEGEE SET NSS (QBA) 33 LONG 46.5"		CHAMP 3329
98485270/ NSS-33L-2	SQUEEGEE SET NSS (QBA) 33 LONG 46.5"		CHAMP 3529
98485610/ NSS-26V-2	SQUEEGEE SET CURVED (QBA)		WRANGLER 26VS
98485620/ NSS-30-3	SQUEEGEE SET (QBA)		WRANGLER 30" TOOL
98485990/ NSS-2026-3	SQUEEGEE SET		WRANGLER 2026

Pullman-Holt

GRACO#/Old Graco#	Material Description	Compatible OEM Part Number	Fits Machines
86849000/ PUL-2000-3C	SQUEEGEE BLADE (NEO)	931614	2000
86848980/ PUL-2000-3A	SQUEEGEE BLADE (GUM)	931692	2000
86849020/ PUL-80-3A	SQUEEGEE BLADE (GUM)	B7529-1	80
86849030/ PUL-80-3B	SQUEEGEE BLADE (GUM)	B7529P-2	80
86849040/ PUL-80-3C	SQUEEGEE BLADE (GUM)	B7529P-3	80
98485380/ PUL-80-3	SQUEEGEE SET		80
98485630/ PUL-2000-3	SQUEEGEE SET		2000
86848930/ PUL-1000-1	SQUEEGEE BLADE (GUM)		1000
86848940/ PUL-14T-5	SQUEEGEE SET		14" SQUEEGEE TOOL
86848960/ PUL-14T-5B	SQUEEGEE BLADE		14" SQUEEGEE TOOL
86848990/ PUL-2000-3B	SQUEEGEE BLADE (NEO)		2000

Star

GRACO#/Old Graco#	Material Description	Compatible OEM Part Number	Fits Machines
86851440/ STR-58-4A	BLADE, GUM	105003	58
86851450/ STR-58-4B	BLADE, GUM 2-1/2"x3/8"x17-1/4" - 17 Hole	105005	58
86851460/ STR-58-4C	BLADE, GUM 2-3/4"x1/4"x39-1/2" - 16 Hole	105007	58
86851510/ STR-58-6D	BLADE, GUM 3"x3/8"x16" - 8 Holes	105029	58
86851650/ STR-75-10A	BLADE, TAN GUM 4"x3/8"x84" -36 Holes	105054	75
86851660/ STR-75-10B	BLADE, NEO 3-1/2"x3/8"x84" -36 Holes	105056	75
86851670/ STR-75-10C	BLADE, TAN GUM 4"x3/8"x16" -8 Holes	105059	75
86851680/ STR-75-10D	BLADE, NEO 3-1/2"x3/8"x16" -8 Holes	105061	75
86851690/ STR-75-10E	BLADE, TAN GUM 4"x3/8"x18-1/2" -8 Holes	105062	75



Star (con't)

GRACO#/Old Graco#	Material Description	Compatible OEM Part Number	Fits Machines
86851700/ STR-75-10F	BLADE, NEO 3-1/2"x3/8"x18-1/2" -8 Holes	105064	75
86851200/ STR-33S-4A	SQUEEGEE BLADE (NEO)	105091	33 STRAIGHT
86851170/ STR-33R-4C	SQUEEGEE BLADE (GUM)	105092	33 ROUND
86851150/ STR-33R-4A	SQUEEGEE BLADE (GUM)	105093	33 ROUND
86851210/ STR-33S-4B	SQUEEGEE BLADE 9 (GUM)	105138, Star 105711	33 STRAIGHT
86851220/ STR-33S-4C	SQUEEGEE BLADE	105139	33 STRAIGHT
86851330/ STR-46R-7A	SQUEEGEE BLADE (GUM)	105263	46 ROUND
86851340/ STR-46R-7B	SQUEEGEE BLADE (GUM)	105264	46 ROUND
86851600/ STR-60S-10B	BLADE, GUM 2-1/2"x1/4"x35-3/4" -17 Holes	105328	60 STRAIGHT
86851590/ STR-60S-10A	BLADE, GUM 2-3/4"x1/4"x39-1/2" -17 Holes	105329	60 STRAIGHT
86851540/ STR-60R-10B	BLADE, GUM 2-7/8"x1/4"x23" - 10 Holes	105330	60 ROUND
86851550/ STR-60R-10C	BLADE, GUM 2-3/4"x1/4"x11" - 4 Holes	105331	60 ROUND
86851630/ STR-60S-10E	BLADE, NEO 2"x14"x32"-15 Holes	105332	60 STRAIGHT
86851390/ STR-46S-7A	SQUEEGEE BLADE (GUM)	105338	46 STRAIGHT
86851400/ STR-46S-7B	SQUEEGEE BLADE (GUM)	105339	46 STRAIGHT
86851410/ STR-46S-7C	SQUEEGEE BLADE (NEO)	105340	46 STRAIGHT
86851290/ STR-460N-3A	SQUEEGEE -GUM	105461	460
86851310/ STR-460N-3C	SQUEEGEE-GUM	105462	460
86851270/ STR-460-3C	SQUEEGEE BLADE (NEO)	105717	460
86851130/ STR-33-4C	SQUEEGEE BLADE (GUM)		33 ROUND
86851230/ STR-33S-4D	SQUEEGEE BLADE (GUM)		33 STRAIGHT
86851240/ STR-460-3	SQUEEGEE SET		460
86851250/ STR-460-3A	SQUEEGEE SET (GUM)		46
86851280/ STR-460N-3	SQUEEGEE SET		460
86851320/ STR-46R-7	SQUEEGEE SET		46 ROUND
86851350/ STR-46R-7C	SQUEEGEE BLADE (GUM)		46 ROUND
86851380/ STR-46S-7	SQUEEGEE SET		46 STRAIGHT
86851420/ STR-46S-7D	SQUEEGEE BLADE (GUM)		46 STRAIGHT
86851470/ STR-58-6	SQUEEGEE SET		58
86851480/ STR-58-6A	SQUEEGEE BLADE		58
86851490/ STR-58-6B	SQUEEGEE BLADE (GUM)		58
86851520/ STR-60R-10	SQUEEGEE SET		60 ROUND
86851530/ STR-60R-10A	SQUEEGEE BLADE (NEO)		60 ROUND
86851560/ STR-60R-10D	SQUEEGEE BLADE (GUM)		60 ROUND
86851570/ STR-60R-10E	SQUEEGEE BLADE (GUM)		60 ROUND
86851580/ STR-60S-10	SQUEEGEE SET		60 STRAIGHT
86851610/ STR-60S-10C	SQUEEGEE BLADE (GUM)		60 STRAIGHT
86851620/ STR-60S-10D	SQUEEGEE BLADE (GUM)		60 STRAIGHT
86851640/ STR-75-10	SQUEEGEE SET		75
86851710/ STR-75-6	SQUEEGEE SET		75

Taski

GRACO#/Old Graco#	Material Description	Compatible OEM Part Number	Fits Machines
86852590/ TS-42-6	SQUEEGEE SET	15200-14	42
86852610/ TS-55-5	SQUEEGEE SET	17200-10, Taski 17200-1	55
86852600/ TS-500-5	SQUEEGEE SET	17503-06	500



Tennant-Nobles

GRACO#/Old Graco#	Material Description	Compatible OEM Part Number	Fits Machines
88060790	SQUEEGEE ASSY, REAR	14571	515
88060790	SQUEEGEE ASSY, REAR	14571	8010
88060790	SQUEEGEE ASSY, REAR	14571	515SS
88060780	Squeegee Assy., front	14575	515
88060780	Squeegee Assy., front	14575	8010
88060780	Squeegee Assy., front	14575	515SS
98486440	Squeegee Kit,Rear Red Blade Assy W/Seals	24304	515
98486440	Squeegee Kit,Rear Red Blade Assy W/Seals	24304	8010
98486440	Squeegee Kit,Rear Red Blade Assy W/Seals	24304	515SS
86844450/ N-20-4B	Blade, Urethane Serrated (QBA) 1-3/8"x3/	27261	Speed Scrub 20
86851880/ T-525-7C	BLADE, NEO (QBA) 2-7/8"x1/8"x47-1/4" -15	56367	525
86851900/ T-525-7E	BLADE, NEO (QBA) 2"x1/4"x27-1/2" -4 Hole	59610	525
86852050/ T-550-6D	BLADE, PLASTIC 2-1/2"x4" (QBA) - 2 Holes	59617	550
86852050/ T-550-6D	BLADE, PLASTIC 2-1/2"x4" (QBA) - 2 Holes	59617	1550
86851940/ T-527-4C	BLADE, NEO (QBA) 2-1/2"x1/8"x49-1/4" -18	59775	527
86851920/ T-527-4A	BLADE, GUM (QBA) 5"x3/8"x48-5/8" -9 Hole	59776	527
88058700	BLADE, SIDE RED 35.75" LONG	60015	1550
88058710	BLADE, RED REAR 68.30" LONG	60016	1550
88058720	BLADE, RED FRONT 64" LONG	60018	1550
86851820/ T-432-3A	BLADE, GUM (QBA) 3-1/2"x1/4"x40-3/8" -9	63035	432
86851840/ T-432-3C	BLADE, NEO (QBA) 2"x1/8"x39-1/2" -9 Hls	63036	432
86851930/ T-527-4B	BLADE, GUM (QBA) 3"x1/4"x46-1/2" -8 Hole	64818	527
88058730	SKIRT,CI NEO.10.6" LONG	71200	7400
88058740	BLADE, RED FRONT 59" LONG	71255	7400
88058750	BLADE, RED REAR 62.30" LONG	71256	7400
88060800	BLADE ASSY, SQGE, SIDE	72934	8400
88060800	BLADE ASSY, SQGE, SIDE	72934	8410
88058770	STRIP, BACK-UP, 35" LONG	75799	1550
86852020/ T-550-6A	BLADE, TAN GUM (QBA) 5"x3/8"x68-1/8" -12	76932	550
86852030/ T-550-6B	BLADE, TAN GUM (QBA) 3"x-1/4"63-3/4" -10	76933	550
88058780	STRIP, BACK-UP, 3.5" WIDE	76937	1550
88058790	BLADE, RED FRONT 68.82" LONG	83809	8410
88058800	BLADE, RED REAR 72.75" LONG	83810	8410
88058810	GASKET, SQUEEGEE	86812	515
88058810	GASKET, SQUEEGEE	86812	8010
88058810	GASKET, SQUEEGEE	86812	8400
88058810	GASKET, SQUEEGEE	86812	515SS
88060810	SQUEEGEE ASSY, SIDE RED	86859	515
88060810	SQUEEGEE ASSY, SIDE RED	86859	7080
88060810	SQUEEGEE ASSY, SIDE RED	86859	7100
88060810	SQUEEGEE ASSY, SIDE RED	86859	7200
88060810	SQUEEGEE ASSY, SIDE RED	86859	7400
88060810	SQUEEGEE ASSY, SIDE RED	86859	8010
88060810	SQUEEGEE ASSY, SIDE RED	86859	515SS
88060810	SQUEEGEE ASSY, SIDE RED	86859	EZ RIDER HP
88060810	SQUEEGEE ASSY, SIDE RED	86859	SPEED SCRUB RIDER
88060810	SQUEEGEE ASSY, SIDE RED	86859	T15
88060810	SQUEEGEE ASSY, SIDE RED	86859	T7
86851760/ T-426-6A	BLADE, TAN GUM (QBA) 4"x3/16"x40" -10 Ho	89031	426
86851770/ T-426-6B	BLADE, TAN GUM (QBA)2-3/4"x1/8"x36-7/8"	89034	426

Squeegees



Tennant-Nobles (con't)

GRACO#/Old Graco#	Material Description	Compatible OEM Part Number	Fits Machines
86851780/ T-426-6C	Blade, Neo Backup (QBA) 3"x1/8"x39"-10 H	89035	426
86898050	BLADE SQUEEGEE, GUM 32" FRONT	222384	5560
86898050	BLADE SQUEEGEE, GUM 32" FRONT	222384	5680-32"
86898050	BLADE SQUEEGEE, GUM 32" FRONT	222384	5700-32"
86898050	BLADE SQUEEGEE, GUM 32" FRONT	222384	Speed Scrub 3301
86898030	BLADE SQUEEGEE, GUM 32" FRONT	222386	5680-32"
86898030	BLADE SQUEEGEE, GUM 32" FRONT	222386	5700-32"
86898020	BLADE SQUEEGEE, GUM 28" REAR	222387	7200
86898020	BLADE SQUEEGEE, GUM 28" REAR	222387	5680-32"
86898020	BLADE SQUEEGEE, GUM 28" REAR	222387	5700-32"
86898040	BLADE SQUEEGEE, GUM 36" FRONT	222414	5680-32"
86898040	BLADE SQUEEGEE, GUM 36" FRONT	222414	5700-32"
86683370	BLADE, SQGE, REAR, 49.37L GUM [36"]	222416	7200
86683370	BLADE, SQGE, REAR, 49.37L GUM [36"]	222416	5680-36"
86683370	BLADE, SQGE, REAR, 49.37L GUM [36"]	222416	5700-36"
86683370	BLADE, SQGE, REAR, 49.37L GUM [36"]	222416	T13
98486770	Squeegee Blade Set, GUM 32" (800 SERIES)	222423	5680-32"
98486770	Squeegee Blade Set, GUM 32" (800 SERIES)	222423	5700-32"
98485170/ T-5736-2	SQUEEGEE SET 36" (QBA)	222424	5680-36"
88053690	Blade, SQ, Front, 3/16 Red, 47.41L (900MM)	223606	7200
88053690	BLADE, SQGE, FRT, 47.41L [LINARD 900MM]	223606	7200
88053690	BLADE, SQGE, FRT, 47.41L [LINARD 900MM]	223606	5680-36"
88053690	BLADE, SQGE, FRT, 47.41L [LINARD 900MM]	223606	5700-36"
88053690	Blade, SQ, Frt, 3/16 Red, 47.41L (900MM)	223606	T15
88053690	BLADE, SQGE, FRT, 47.41L[LINARD 900MM]	223606	T15
86685910/ N-2400-S	SPLASH GUARD	240271	SPEED SCRUB 1701
86685910/ N-2400-S	SPLASH GUARD	240271	SPEED SCRUB 2001
86685910/ N-2400-S	SPLASH GUARD	240271	SPEED SCRUB 2400
86602970/ N-3301-S	SPLASHGUARD	240276	5560
86602970/ N-3301-S	SPLASHGUARD	240276	Speed Scrub 2701
86602970/ N-3301-S	SPLASHGUARD	240276	Speed Scrub 3301
86602990/ N-2701-S	SPLASH GUARD	240277	5540
86602990/ N-2701-S	SPLASH GUARD	240277	Speed Scrub 2701
86602990/ N-2701-S	SPLASH GUARD	240277	Speed Scrub 3301
86844750/ N-33-4A	Blade, Urethane (QBA) 1-5/16"x1/8"x40-3/	240292	Speed Scrub 2700
86844750/ N-33-4A	Blade, Urethane (QBA) 1-5/16"x1/8"x40-3/	240292	Speed Scrub 3300
86844760/ N-33-4B	Blade, Urethane Serrated 1-3/8"x1/8"x40-3	240293	Speed Scrub 2700
86844760/ N-33-4B	Blade, Urethane Serrated 1-3/8"x1/8"x40-3	240293	Speed Scrub 3300
86844620/ N-27-4A	Blade, Urethane (QBA) W-3/8"x1/8"x34-3/4	240294	Speed Scrub 2700
86844620/ N-27-4A	Blade, Urethane (QBA) W-3/8"x1/8"x34-3/4	240294	Speed Scrub 3300
86844630/ N-27-4B	Blade, Urethane Serrated 1-3/8"x1/8"x34-3	240295	Speed Scrub 2700
86844630/ N-27-4B	Blade, Urethane Serrated 1-3/8"x1/8"x34-3	240295	Speed Scrub 3300
88060820	BLADE ASSY, SQGE, SIDE	363123	515
88060820	BLADE ASSY, SQGE, SIDE	363123	8010
88060820	BLADE ASSY, SQGE, SIDE	363123	515SS
88058850	BLADE, RED FRONT 56.68" LONG	365322	8200
88058850	BLADE, RED FRONT 56.68" LONG	365322	8210
88058860	BLADE, RED REAR 64.13" LONG	365323	8200
88058860	BLADE, RED REAR 64.13" LONG	365323	8210
88060840	BLADE ASSY, SQGE, 28.6L	386260	7300



Tennant-Nobles (con't)

GRACO#/Old Graco#	Material Description	Compatible OEM Part Number	Fits Machines
88060840	BLADE ASSY, SQGE, 28.6L	386260	8300
88058880	BLADE, RED FRONT 49" LONG	386283	7300
88058880	BLADE, RED FRONT 49" LONG	386283	8300
88058890	BLADE, RED REAR 51.38" LONG	386284	7300
88058890	BLADE, RED REAR 51.38" LONG	386284	8300
88058900	SKIRT,CI NEO.47.19" LONG	386387	7300
88058900	SKIRT,CI NEO.47.19" LONG	386387	8300
88058910	SKIRT,CI NEO.15.66" LONG	386388	7300
88058910	SKIRT,CI NEO.15.66" LONG	386388	8300
88050840	BLADE SQUEEGEE,GUM REAR 32"(44"L)	390734	7080
88050840	BLADE SQUEEGEE,GUM REAR 32"(44"L)	390734	7100
88050840	BLADE SQUEEGEE,GUM REAR 32"(44"L)	390734	EZ Rider HP
88050020	BLADE SQUEEGEE,RED REAR 32"(44"L)	390922	7080
88050020	BLADE SQUEEGEE,RED REAR 32"(44"L)	390922	7100
88050020	BLADE SQUEEGEE,RED REAR 32"(44"L)	390922	EZ Rider HP
88050020	BLADE SQUEEGEE,RED REAR 32"(44"L)	390922	Speed Scrub
88050020	BLADE SQUEEGEE,RED REAR 32"(44"L)	390922	T7
88058920	BLADE, LH SIDE 21.41"LONG	392842	7080
88058920	BLADE, LH SIDE 21.41"LONG	392842	EZ RIDER HP
86701720	SQUEEGEE BLADE FRT	600207	5280
86701720	SQUEEGEE BLADE FRT	600207	5300
86603100/ N-2601-S	SPLASHGUARD	600294	5500
86603100/ N-2601-S	SPLASHGUARD	600294	5520
86603100/ N-2601-S	SPLASHGUARD	600294	SPEED SCRUB 2401
86603100/ N-2601-S	SPLASHGUARD	600294	SPEED SCRUB 2601
86844490/ N-2401-S	SPLASHGUARD (QBA)	600295	5500
86844490/ N-2401-S	SPLASHGUARD (QBA)	600295	5520
86844490/ N-2401-S	SPLASHGUARD (QBA)	600295	SPPED SCRUB 2401
86844490/ N-2401-S	SPLASHGUARD (QBA)	600295	SPPED SCRUB 2601
86693190/ N-2001-S	SPLASH GUARD	605958	5200
86693190/ N-2001-S	SPLASH GUARD	605958	BA-2000
86693190/ N-2001-S	SPLASH GUARD	605958	FS-2000
86693190/ N-2001-S	SPLASH GUARD	605958	SPEED SCRUB 2001
86859660	Blade,Sqge,Rear 40.92"L GUM X-WIDE 3/16"	609056	5400
86859660	Blade,Sqge,Rear 40.92"L GUM X-WIDE 3/16"	609056	5540
86859660	Blade,Sqge,Rear 40.92"L GUM X-WIDE 3/16"	609056	Speed Scrub 2701
88058570	SQUEEGEE BLADE-REAR RED 31.8 LONG	610150	5280
88058570	SQUEEGEE BLADE-REAR RED 31.8 LONG	610150	5300
88058580	SQUEEGEE BLADE- FRONT RED 30"LONG	630288	5200
88058580	SQUEEGEE BLADE- FRONT RED 30"LONG	630288	5280
88058580	SQUEEGEE BLADE- FRONT RED 30"LONG	630288	5300
88058930	BLADE, RH SIDE 23.01"LONG	1001290	7080
88058930	BLADE, RH SIDE 23.01"LONG	1001290	7100
88058930	BLADE, RH SIDE 23.01"LONG	1001290	EZ RIDER HP
86646510/ T-T3R-2B	SQUEEGE BLADE FRONT	1011232	A5
86646510/ T-T3R-2B	SQUEEGE BLADE FRONT	1011232	SPEED SCRUB 17-20"
86646510/ T-T3R-2B	SQUEEGE BLADE FRONT	1011232	T3
86646510/ T-T3R-2B	SQUEEGE BLADE FRONT	1011232	T5
88058940	SKIRT,CI NEO.33.51" LONG	1011376	SSR (32")
88058940	SKIRT,CI NEO.33.51" LONG	1011376	T7

Squeegees



Tennant-Nobles (con't)

GRACO#/Old Graco#	Material Description	Compatible OEM Part Number	Fits Machines
86646530/ T-T3R-2A	SQUEEGE BLADE REAR	1011456	A5
86646530/ T-T3R-2A	SQUEEGE BLADE REAR	1011456	SPEED SCRUB 17-20"
86646530/ T-T3R-2A	SQUEEGE BLADE REAR	1011456	T3
86646530/ T-T3R-2A	SQUEEGE BLADE REAR	1011456	T5
88058950	SKIRT,CI NEO.27.27" LONG	1013531	SSR (26")
88058950	SKIRT,CI NEO.27.27" LONG	1013531	T7
86852640/ T-T3-2B	SQUEEGEE BLADE FRT 32" 1/8" GUM TN/T3	1014091	A5
86852640/ T-T3-2B	SQUEEGEE BLADE FRT 32" 1/8" GUM TN/T3	1014091	SPEED SCRUB
86852640/ T-T3-2B	SQUEEGEE BLADE FRT 32" 1/8" GUM TN/T3	1014091	T3
86852640/ T-T3-2B	SQUEEGEE BLADE FRT 32" 1/8" GUM TN/T3	1014091	T5
86852630/ T-T3-2A	SQUEEGEE BLADE,REAR 3/16" GUM TN T3	1014093	A5
86852630/ T-T3-2A	SQUEEGEE BLADE,REAR 3/16" GUM TN T3	1014093	SPEED SCRUB
86852630/ T-T3-2A	SQUEEGEE BLADE,REAR 3/16" GUM TN T3	1014093	T3
86852630/ T-T3-2A	SQUEEGEE BLADE,REAR 3/16" GUM TN T3	1014093	T5
88054320	SQUEEGEE BLADE, FRONT RED	1017868	M20
88054320	SQUEEGEE BLADE, FRONT RED	1017868	T20
88054330	SIDE SKIRT, NEO	1019295	M20
88054330	SIDE SKIRT, NEO	1019295	M30
88054330	SIDE SKIRT, NEO	1019295	T20
86772770	SQ BLADE RED	1021333	A5
86772770	SQ BLADE RED	1021333	SPEED SCRUB
86772770	SQ BLADE RED	1021333	T5
86772760	SQ BLADE RED	1021804	A5
86772760	SQ BLADE RED	1021804	SPEED SCRUB
86772760	SQ BLADE RED	1021804	T5
86602810	SKIRT, HEAD, DISK, 32.0/800MM	1022013	5680-32"
86731280	Sq. Blade - 26/28" RED	1023327	A5
86731280	Sq. Blade - 26/28" RED	1023327	SPEED SCRUB
86731280	Sq. Blade - 26/28" RED	1023327	T5
88054340	SIDE SKIRT, NEO	1024586	M20
88054340	SIDE SKIRT, NEO	1024586	M30
88054340	SIDE SKIRT, NEO	1024586	T20
86891310	BLADE, SQ, FRONT-GUM 24	1025333	A5
86891310	BLADE, SQ, FRONT-GUM 24	1025333	Speed Scrub
86891310	BLADE, SQ, FRONT-GUM 24	1025333	T5
86892950	SQUEEGEE, GUM 42-7/8X2 13 HOLES	1025335	A5
86892950	SQUEEGEE, GUM 42-7/8X2 13 HOLES	1025335	Speed Scrub
86892950	SQUEEGEE, GUM 42-7/8X2 13 HOLES	1025335	T5
86892940	SQ, GUM 43-1/2X1-15/16 13 Holes 20 Notch	1025337	A5
86892940	SQ, GUM 43-1/2X1-15/16 13 Holes 20 Notch	1025337	Speed Scrub
86892940	SQ, GUM 43-1/2X1-15/16 13 Holes 20 Notch	1025337	T5
86892930	SQUEEGEE, GUM 45-1/2X2" 13 HOLES	1025340	A5
86892930	SQUEEGEE, GUM 45-1/2X2" 13 HOLES	1025340	Speed Scrub
86892930	SQUEEGEE, GUM 45-1/2X2" 13 HOLES	1025340	T5
86892920	SQ, GUM 48 1/2X1-15/16 13 Holes 17 Notch	1025342	A5
86892920	SQ, GUM 48 1/2X1-15/16 13 Holes 17 Notch	1025342	Speed Scrub
86892920	SQ, GUM 48 1/2X1-15/16 13 Holes 17 Notch	1025342	T5
86892910	SQUEEGEE GUM 50-5/8X2 13 HOLES	1025344	A5
86892910	SQUEEGEE GUM 50-5/8X2 13 HOLES	1025344	Speed Scrub
86892910	SQUEEGEE GUM 50-5/8X2 13 HOLES	1025344	T5



Tennant-Nobles (con't)

GRACO#/Old Graco#	Material Description	Compatible OEM Part Number	Fits Machines
86864190	SKIRT, CYLINDRICAL	1026292	A5
86864190	SKIRT, CYLINDRICAL	1026292	SPEED SCRUB 24-32"
86864190	SKIRT, CYLINDRICAL	1026292	T5
88054360	SQUEEGEE BLADE,SIDE RED	1031011	M20
88054360	SQUEEGEE BLADE,SIDE RED	1031011	M30
88054360	SQUEEGEE BLADE,SIDE RED	1031011	T20
88054370	SQUEEGEE BLADE, REAR RED	1031331	M20
88054370	SQUEEGEE BLADE, REAR RED	1031331	T20
88054380	SQUEEGEE BLADE, REAR RED M30	1035052	M30
88054390	SQUEEGEE BLADE, FRONT RED M30	1035067	M30
98486000/ TN-17-6	SQUEEGEE SET	19920100	Servomatic 17
86678170/ WR-26-3A	SQUEEGEE BLADE	067760601	260
86678170/ WR-26-3A	SQUEEGEE BLADE	067760601	260XP
86678170/ WR-26-3A	SQUEEGEE BLADE	067760601	265XP
86678170/ WR-26-3A	SQUEEGEE BLADE	067760601	Servomatic 26
86684870/ WR-26-3B	BLADE BACKUP	067760603	260
86684870/ WR-26-3B	BLADE BACKUP	067760603	260XP
86684870/ WR-26-3B	BLADE BACKUP	067760603	265XP
86684870/ WR-26-3B	BLADE BACKUP	067760603	Servomatic 26
86856100/ WR-32-3A	BLADE, TAN GUM 3-3/4"x3/16"x49-1/4" -10	067761601	320
86856100/ WR-32-3A	BLADE, TAN GUM 3-3/4"x3/16"x49-1/4" -10	067761601	320XP
86856100/ WR-32-3A	BLADE, TAN GUM 3-3/4"x3/16"x49-1/4" -10	067761601	Servomatic 32
86856120/ WR-32-3C	BLADE, TAN GUM 2-3/4"x1/8"x46-3/8" -10 H	067761602	320
86856120/ WR-32-3C	BLADE, TAN GUM 2-3/4"x1/8"x46-3/8" -10 H	067761602	320XP
86856120/ WR-32-3C	BLADE, TAN GUM 2-3/4"x1/8"x46-3/8" -10 H	067761602	Servomatic 32
86856110/ WR-32-3B	BLADE, NEO 3"x1/8"48-3/4" -10 Holes	067761603	320
86856110/ WR-32-3B	BLADE, NEO 3"x1/8"48-3/4" -10 Holes	067761603	320XP
86856110/ WR-32-3B	BLADE, NEO 3"x1/8"48-3/4" -10 Holes	067761603	Servomatic 32
86852330/ TN-16T-4	SQUEEGEE SET	199201001	16" SQUEEGEE TOOL
98485130/ Tennant 199201017, Graco WR-26-3	SQUEEGEE SET	199201017	260
98485130/ WR-26-3	SQUEEGEE SET	199201017	260XP
98485130/ WR-26-3	SQUEEGEE SET	199201017	265XP
98485140/ WR-32-3	SQUEEGEE SET	199201018	Servomatic 32
86683370/ WR-26-3B	Squeegee Blade, GUM REAR, 36" T-5736-2GA	067760603	Servomatic 26
86844510/ N-24-2A	BLADE, GUM (QBA) 2-1/4"x1/4"x25-1/2" -12	0174..34	SPEED DRY
86678180/ WR-26-3C	SQUEEGEE BLADE	067760602	260
86678180/ WR-26-3C	SQUEEGEE BLADE	067760602	260XP
86678180/ WR-26-3C	SQUEEGEE BLADE	067760602	265XP
86678180/ WR-26-3C	SQUEEGEE BLADE	067760602	Servomatic 26
86683370/ WR-26-3B	Squeegee Blade, GUM REAR, 36" T-5736-2GA	067760603	260
86683370/ WR-26-3B	Squeegee Blade, GUM REAR, 36" T-5736-2GA	067760603	260XP
86683370/ WR-26-3B	Squeegee Blade, GUM REAR, 36" T-5736-2GA	067760603	265XP
86731290	Sq. Blade - 26/28 " RED	1023329	A5
86731290	Sq. Blade - 26/28 " RED	1023329	SPEED SCRUB 26"
86731290	Sq. Blade - 26/28 " RED	1023329	T5-26"
86731300	SQUEEGEE / 32" RED FRONT	1023398	A5
86731300	SQUEEGEE / 32" RED FRONT	1023398	SPEED SCRUB 32"
86731300	SQUEEGEE / 32" RED FRONT	1023398	T5-32"
86731310	BLADE / 32" RED REAR	1023399	1500

Squeegees



Tennant-Nobles (con't)

GRACO#/Old Graco#	Material Description	Compatible OEM Part Number	Fits Machines
86731310	BLADE / 32" RED REAR	1023399	1510
86731310	BLADE / 32" RED REAR	1023399	1620
86731310	BLADE / 32" RED REAR	1023399	5280
86731310	BLADE / 32" RED REAR	1023399	5300
86731310	BLADE / 32" RED REAR	1023399	SENTRY
86731310	BLADE / 32" RED REAR	1023399	SPEED SCRUB 2001HD
86731310	BLADE / 32" RED REAR	1023399	SPEED SCRUB 2601
86897890/ T-5732-2B	BLADE, RED 2"x1/8"x43" -15 Hls/Ntchs	222241	5560
86897890/ N-3301R-2B T-5732-2B	BLADE, RED 2"x1/8"x43" -15 Hls/Ntchs	222241	5680-32"
86897890/ N-3301R-2B T-5732-2B	BLADE, RED 2"x1/8"x43" -15 Hls/Ntchs	222241	5700-32"
86897890/ N-3301R-2B T-5732-2B	BLADE, RED 2"x1/8"x43" -15 Hls/Ntchs	222241	Speed Scrub 3301
86897880/ T-5732-2A	BLADE, RED 2"x-1/4"x45-1/2" -15 Holes	222242,	5680-32"
86897880/ T-5732-2A	BLADE, RED 2"x-1/4"x45-1/2" -15 Holes	222242,	5700-32"
86897870/ T-5728-2B	BLADE, RED 2"x1/8"x38-3/4" -13 Hls/5 Ntc	222381,	5400
86897870/ T-5728-2B	BLADE, RED 2"x1/8"x38-3/4" -13 Hls/5 Ntc	222381,	5540
86897870/ T-5728-2B	BLADE, RED 2"x1/8"x38-3/4" -13 Hls/5 Ntc	222381,	7200
86897870/ T-5728-2B	BLADE, RED 2"x1/8"x38-3/4" -13 Hls/5 Ntc	222381,	5680-28"
86897870/ T-5728-2B	BLADE, RED 2"x1/8"x38-3/4" -13 Hls/5 Ntc	222381,	5700-28"
86897870/ T-5728-2B	BLADE, RED 2"x1/8"x38-3/4" -13 Hls/5 Ntc	222381,	Speed Scrub 2701
86897860/ T-5728-2A	BLADE, RED 2"x1/4"x41" -13 Holes (rear)	222382,	7200
86897860/ T-5728-2A	BLADE, RED 2"x1/4"x41" -13 Holes (rear)	222382,	5680-28"
86897860/ T-5728-2A	BLADE, RED 2"x1/4"x41" -13 Holes (rear)	222382,	5700-28"
88051380/ T-5732-2GA	BLADE SQUEEGEE, GUM 28" FRONT	222385	5400
88051380/ T-5732-2GA	BLADE SQUEEGEE, GUM 28" FRONT	222385	5540
88051380/ T-5732-2GA	BLADE SQUEEGEE, GUM 28" FRONT	222385	7200
88051380/ T-5732-2GA	BLADE SQUEEGEE, GUM 28" FRONT	222385	5680-32"
88051380/ T-5732-2GA	BLADE SQUEEGEE, GUM 28" FRONT	222385	5700-32"
88051380/ T-5732-2GA	BLADE SQUEEGEE, GUM 28" FRONT	222385	Speed Scrub 2701
86622000/ T-5736-2B	SQUEEGEE 36 FRONT	222413,	5680-36"
86622000/ T-5736-2B	SQUEEGEE 36 FRONT	222413,	5700-36"
86622000/ T-5736-2B	SQUEEGEE 36 FRONT	222413,	Tuffscrub 3300
86622010/ T-5736-2A	SQUEEGEE 36 REAR	222415,	7200
86622010/ T-5736-2A	BLADE, SQGE, REAR, 49.37L RED (900MM)	222415,	7200
86622010/ T-5736-2A	SQUEEGEE 36 REAR	222415,	5680-36"
86622010/ T-5736-2A	BLADE, SQGE, REAR, 49.37L RED (900MM)	222415,	5680-36"
86622010/ T-5736-2A	SQUEEGEE 36 REAR	222415,	5700-36"
86622010/ T-5736-2A	BLADE, SQGE, REAR, 49.37L RED (900MM)	222415,	5700-36"
86622010/ T-5736-2A	SQUEEGEE 36 REAR	222415,	T15
86622010/ T-5736-2A	BLADE, SQGE, REAR, 49.37L RED (900MM)	222415,	T15
86844550/ N-2700-2B	Blade, NEO (QBA) 1-1/4"x1/16"x32-1/2" -1	240221,	SS2700
86844540/ N-2700-2A	Blade, GUM (QBA) 1-1/2"x3/16"x35" -12 Ho	240223,	SS2700
86844300/ N-1701-4A	BLADE, URETHANE (QBA) 1-1/2"x1/8"x25" -	240296,	Speed Scrub 1701
86844300/ N-1701-4A	BLADE, URETHANE (QBA) 1-1/2"x1/8"x25" -	240296,	Speed Scrub 1701
86844300/ N-1701-4A	BLADE, URETHANE (QBA) 1-1/2"x1/8"x25" -	240296,	Speed Scrub 2001
86844300/ N-1701-4A	BLADE, URETHANE (QBA) 1-1/2"x1/8"x25" -	240296,	Speed Scrub 2400
86844310/ N-1701-4B	Blade, Urethane Serrated (QBA) 1-1/2"x1/	240297,	Speed Scrub 1701
86844310/ N-1701-4B	Blade, Urethane Serrated (QBA) 1-1/2"x1/	240297,	Speed Scrub 2001
86844310/ N-1701-4B	Blade, Urethane Serrated (QBA) 1-1/2"x1/	240297,	Speed Scrub 2400



Tennant-Nobles (con't)

GRACO#/Old Graco#	Material Description	Compatible OEM Part Number	Fits Machines
86844380/ N-2001-4A	Blade, Urethane (QBA) 1-7/16"x3/32"x27-3	240298,	Speed Scrub 1701
86844380/ N-2001-4A	BLADE, URETHANE (QBA) 1-7/16"x3/32"x27-3	240298,	Speed Scrub 2001
86844380/ N-2001-4A	BLADE, URETHANE (QBA) 1-7/16"x3/32"x27-3	240298,	Speed Scrub 2400
86844390/ N-2001-4B	Blade,Urethane Serrated (QBA)1-3/8"x3/32"	240299,	Speed Scrub 1701
86844390/ N-2001-4B	Blade,Urethane Serrated (QBA)1-3/8"x3/32"	240299,	Speed Scrub 2001
86844390/ N-2001-4B	Blade,Urethane Serrated (QBA)1-3/8"x3/32"	240299,	Speed Scrub 2400
86844280/ N-1700-2B	BLADE, NEO (QBA) 1-1/8"x1/16"x25-1/2" -9	240301,	SS1700
86844360/ N-2000-2B	BLADE, NEO (QBA) 1-1/4"x1/16"x22-1/4" -	240302,	Speed Scrub 2400
86844270/ N-1700-2A	BLADE, GUM 1-3/8"x3/16"x28" (QBA) - 9 Ho	240303,	SS1700
86844350/ N-2000-2A	BLADE, GUM (QBA) 1-5/8"x3/16"x25" - 9 Ho	240304,	Speed Scrub 2001
86844440/ N-20-4A"	BLADE,URE.1-3/8"x3/32"x24-8 Holes/45NOTC	27260	Speed Scrub 20
88050030	BLADE SQUEEGEE, RED FRONT 32" (41.5"L)	390923	7080
88050030	BLADE SQUEEGEE, RED FRONT 32" (41.5"L)	390923	7100
88050030	BLADE SQUEEGEE, RED FRONT 32" (41.5"L)	390923	EZ Rider HP
88050030	BLADE SQUEEGEE, RED FRONT 32" (41.5"L)	390923	Speed Scrub
88050030	BLADE SQUEEGEE, RED FRONT 32" (41.5"L)	390923	T7
86852180/ T-7128-2C	BLADE, REAR GUM (QBA) (OPTIONAL)	390936,	7080
86852180/ T-7128-2C	BLADE, REAR GUM (QBA) (OPTIONAL)	390936,	7100
86852180/ T-7128-2C	BLADE, REAR GUM (QBA) (OPTIONAL)	390936,	EZ Rider
86852180/ T-7128-2C	BLADE, REAR GUM (QBA) (OPTIONAL)	390936,	EZ Rider HP
86852180/ T-7128-2C	BLADE, REAR GUM (QBA) (OPTIONAL)	390936,	Speed Scrub
86852180/ T-7128-2C	BLADE, REAR GUM (QBA) (OPTIONAL)	390936,	T7
86688740/ T-7128-2A	REAR BLADE	390942,	7080
86688740/ T-7128-2A	REAR BLADE	390942,	7100
86688740/ T-7128-2A	REAR BLADE	390942,	EZ RIDER HP
86688740/ T-7128-2A	REAR BLADE	390942,	SPEED SCRUB
86688740/ T-7128-2A	REAR BLADE	390942,	T7
86688750/ T-7128-2B	SQUEEGEE BLADE	390943,	7080
86688750/ T-7128-2B	SQUEEGEE BLADE	390943,	7100
86688750/ T-7128-2B	SQUEEGEE BLADE	390943,	EZ RIDER HP
86688750/ T-7128-2B	SQUEEGEE BLADE	390943,	EZ Rider
86688750/ T-7128-2B	SQUEEGEE BLADE	390943,	SPEED SCRUB
86688750/ T-7128-2B	SQUEEGEE BLADE	390943,	T7
86660820/ N-5100-2B	SQUEEGEE	601454,	5100
86660820/ N-5100-2B	SQUEEGEE	601454,	Speed Scrub 1701
86660800/ N-5100-2A	SQUEEGEE	601455,	5100
86660800/ N-5100-2A	SQUEEGEE	601455,	Speed Scrub 1701
86844820/ N-5100R-2B	BLADE, SQGE, (QBA) FRONT 26.38"L RED LIN	601485	5100
86844820/ N-5100R-2B	BLADE, SQGE, (QBA) FRONT 26.38"L RED LIN	601485	Speed Scrub 1701
86844810/ N-5100R-2A	BLADE, SQGE, (QBA) REAR 26.88"L RED LINA	601486	5100
86844810/ N-5100R-2A	BLADE, SQGE, (QBA) REAR 26.88"L RED LINA	601486	Speed Scrub 1701
86602870/ N-2001N-2A	BLADE SQUEEGEE, 27" 2001 (QBA)	603659	3500
86602870/ N-2001N-2A	BLADE SQUEEGEE, 27" 2001 (QBA)	603659	3520
86602870/ N-2001N-2A	BLADE SQUEEGEE, 27" 2001 (QBA)	603659	5200
86602870/ N-2001N-2A	BLADE SQUEEGEE, 27" 2001 (QBA)	603659	16-gal Wet/Dry Vacuum
86602870/ N-2001N-2A	BLADE SQUEEGEE, 27" 2001 (QBA)	603659	BA-2000
86602870/ N-2001N-2A	BLADE SQUEEGEE, 27" 2001 (QBA)	603659	FS-2000
86602870/ N-2001N-2A	BLADE SQUEEGEE, 27" 2001 (QBA)	603659	SPEED SCRUB 1701
86602870/ N-2001N-2A	BLADE SQUEEGEE, 27" 2001 (QBA)	603659	SPEED SCRUB 2001
86602870/ N-2001N-2A	BLADE SQUEEGEE, 27" 2001 (QBA)	603659	SPEED SCRUB 2400

Squeegees



Tennant-Nobles (con't)

GRACO#/Old Graco#	Material Description	Compatible OEM Part Number	Fits Machines
86602870/ N-2001N-2A	BLADE SQUEEGEE, 27" 2001 (QBA)	603659	TYPHOON
86602870/ N-2001N-2A	BLADE SQUEEGEE, 27" 2001 (QBA)	603659	TYPHOON 16B
86622020/ N-2401N-2A	SQ. BLADE 2401, 31"	603660	5500
86622020/ N-2401N-2A	SQ. BLADE 2401, 31"	603660	5520
86622020/ N-2401N-2A	SQ. BLADE 2401, 31"	603660	SPEED SCRUB 1701
86622020/ N-2401N-2A	SQ. BLADE 2401, 31"	603660	SPEED SCRUB 2001
86622020/ N-2401N-2A	SQ. BLADE 2401, 31"	603660	SPEED SCRUB 2001HD
86622020/ N-2401N-2A	SQ. BLADE 2401, 31"	603660	SPEED SCRUB 2400
86622020/ N-2401N-2A	SQ. BLADE 2401, 31"	603660	SPEED SCRUB 2401
86622020/ N-2401N-2A	SQ. BLADE 2401, 31"	603660	SPEED SCRUB 2601
86603010/ N-2701N-2A	BLADE, SQUEEGEE 34" 2701 (QBA)	603661	500
86603010/ N-2701N-2A	BLADE, SQUEEGEE 34" 2701 (QBA)	603661	3500
86603010/ N-2701N-2A	BLADE, SQUEEGEE 34" 2701 (QBA)	603661	3520
86603010/ N-2701N-2A	BLADE, SQUEEGEE 34" 2701 (QBA)	603661	3540
86603010/ N-2701N-2A	BLADE, SQUEEGEE 34" 2701 (QBA)	603661	5520
86603010/ N-2701N-2A	BLADE, SQUEEGEE 34" 2701 (QBA)	603661	5540
86603010/ N-2701N-2A	BLADE, SQUEEGEE 34" 2701 (QBA)	603661	5560
86603010/ N-2701N-2A	BLADE, SQUEEGEE 34" 2701 (QBA)	603661	16-gal Wet/Dry Vacuum
86603010/ N-2701N-2A	BLADE, SQUEEGEE 34" 2701 (QBA)	603661	Speed Scrub 2401
86603010/ N-2701N-2A	BLADE, SQUEEGEE 34" 2701 (QBA)	603661	Speed Scrub 2601
86603010/ N-2701N-2A	BLADE, SQUEEGEE 34" 2701 (QBA)	603661	Speed Scrub 2701
86603010/ N-2701N-2A	BLADE, SQUEEGEE 34" 2701 (QBA)	603661	Speed Scrub 3301
86603010/ N-2701N-2A	BLADE, SQUEEGEE 34" 2701 (QBA)	603661	TYPHOON EB
86603010/ N-2701N-2A	BLADE, SQUEEGEE 34" 2701 (QBA)	603661	TYPHOON EV
86648660/ N-3301N-2A	BLADE	603662	3520
86648660/ N-3301N-2A	BLADE	603662	3540
86648660/ N-3301N-2A	BLADE	603662	5540
86648660/ N-3301N-2A	BLADE	603662	5560
86648660/ N-3301N-2A	BLADE	603662	SPEED SCRUB 2701
86648660/ N-3301N-2A	BLADE	603662	SPEED SCRUB 3301
86648660/ N-3301N-2A	BLADE	603662	Typhoon 16B
86648660/ N-3301N-2A	BLADE	603662	TYPHOON EV
86648660/ N-3301N-2A	BLADE	603662	Typhoon EV
86844910/ N-5400G-2A	SQGE, REAR 36"L GUMRBR (QBA) [5400]	605027	5400
86844910/ N-5400G-2A	SQGE, REAR 36"L GUMRBR (QBA) [5400]	605027	5500
86844910/ N-5400G-2A	SQGE, REAR 36"L GUMRBR (QBA) [5400]	605027	5520
86844910/ N-5400G-2A	SQGE, REAR 36"L GUMRBR (QBA) [5400]	605027	SPEED SCRUB 2001
86844910/ N-5400G-2A	SQGE, REAR 36"L GUMRBR (QBA) [5400]	605027	SPEED SCRUB 2401
86844910/ N-5400G-2A	SQGE, REAR 36"L GUMRBR (QBA) [5400]	605027	SPEED SCRUB 2601
86844920/ N-5400G-2B	SQGE, FRONT 34"L GUMRBR (QBA) [5400]	605028	5400
86844920/ N-5400G-2B	SQGE, FRONT 34"L GUMRBR (QBA) [5400]	605028	5500
86844920/ N-5400G-2B	SQGE, FRONT 34"L GUMRBR (QBA) [5400]	605028	5520
86844920/ N-5400G-2B	SQGE, FRONT 34"L GUMRBR (QBA) [5400]	605028	SPEED SCRUB 2001
86844920/ N-5400G-2B	SQGE, FRONT 34"L GUMRBR (QBA) [5400]	605028	SPEED SCRUB 2401
86844920/ N-5400G-2B	SQGE, FRONT 34"L GUMRBR (QBA) [5400]	605028	SPEED SCRUB 2601
86844880/ N-5400-2A	SQGE, REAR 36"L RED (QBA) [5400]	605029,	5400
86844880/ N-5400-2A	SQGE, REAR 36"L RED (QBA) [5400]	605029,	5500
86844880/ N-5400-2A	SQGE, REAR 36"L RED (QBA) [5400]	605029,	5520
86844880/ N-5400-2A	SQGE, REAR 36"L RED (QBA) [5400]	605029,	Speed Scrub 2001HD
86844880/ N-5400-2A	SQGE, REAR 36"L RED (QBA) [5400]	605029,	Speed Scrub 2401

Squeegees



Tennant-Nobles (con't)

GRACO#/Old Graco#	Material Description	Compatible OEM Part Number	Fits Machines
86844880/ N-5400-2A	SQGE, REAR 36"L RED (QBA) [5400]	605029,	Speed Scrub 2601
86844890/ N-5400-2B	SQGE, FRONT 34"L RED (QBA) [5400]	605030	5400
86844890/ N-5400-2B	SQGE, FRONT 34"L RED (QBA) [5400]	605030	5500
86844890/ N-5400-2B	SQGE, FRONT 34"L RED (QBA) [5400]	605030	5520
86844890/ N-5400-2B	SQGE, FRONT 34"L RED (QBA) [5400]	605030	Speed Scrub 2001HD
86844890/ N-5400-2B	SQGE, FRONT 34"L RED (QBA) [5400]	605030	Speed Scrub 2401
86844890/ N-5400-2B	SQGE, FRONT 34"L RED (QBA) [5400]	605030	Speed Scrub 2601
86844640/ N-3301-2A	Squeegee Blade Each, (QBA) 40"L, 1/8" GU	606682	Speed Scrub 3301
98485180/ N-5400-2	SQGE, SET RED [5400](QBA)	606752	5700-32"
98485580/ N-5400G-2	SQGE, SET GUMRBR (QBA) [5400]	606757	5400
98485580/ N-5400G-2	SQGE, SET GUMRBR (QBA) [5400]	606757	5500
98485580/ N-5400G-2	SQGE, SET GUMRBR (QBA) [5400]	606757	5520
98485580/ N-5400G-2	SQGE, SET GUMRBR (QBA) [5400]	606757	Speed Scrub 2001HD
98485580/ N-5400G-2	SQGE, SET GUMRBR (QBA) [5400]	606757	Speed Scrub 2401
98485580/ N-5400G-2	SQGE, SET GUMRBR (QBA) [5400]	606757	Speed Scrub 2601
86844590/ N-2701R-2A	BLADE, SQGE, (QBA) Rear 40.92"L Red Lina	609055	5400
86844590/ N-2701R-2A	BLADE, SQGE, (QBA) Rear 40.92"L Red Lina	609055	5540
86844590/ N-2701R-2A	BLADE, SQGE, (QBA) Rear 40.92"L Red Lina	609055	SPEED SCRUB 2701
98485540/ N-2701R-2	SQUEEGEE SET NOBLES 2701 (QBA)	609115	SPEED SCRUB 2701
98484800/ N-2701N-2	Squeegee Set, Ridged Urethane, 2701 (QBA)	609116	5400
86844720/ N-3301R-2A	BLADE, REAR, RED RED (QBA) 45.6" (XR)	611402	5560
86844720/ N-3301R-2A	BLADE, REAR, RED RED (QBA) 45.6" (XR)	611402	Speed Scrub 3301
86844650/ N-3301G-2A	BLADE, REAR, GUM 45.6" (QBA)	611405	5560
86844650/ N-3301G-2A	BLADE, REAR, GUM 45.6" (QBA)	611405	Speed Scrub 3301
86702620/ T-2001XR-2A	BLADE	612792	5200
86702620/ T-2001XR-2A	BLADE	612792	SPEED SCRUB 2001
86851740/ T-2001XR-2B	BLADE, SQUEEGEE FRONT RED (QBA)	612980	5200
86851740/ T-2001XR-2B	BLADE, SQUEEGEE FRONT RED (QBA)	612980	Speed Scrub 2001
86657360/ N-5300-3C	SQUEEGEE	630291,	5200
86657360/ N-5300-3C	SQUEEGEE	630291,	5280
86657360/ N-5300-3C	SQUEEGEE	630291,	5300
86657360/ N-5300-3C	SQUEEGEE	630291,	SPEED SCRUB 2001
86657370/ N-5300-3B	BACK UP SQUEEGEE	630340,	5300
86658080/ N-5300-3A	SQUEEGEE BLADE	630344,	5300
86658080/ N-5300-3A	SQUEEGEE BLADE	630344,	5380
86851830/ T-432-3B	BLADE, GUM (QBA) 2-1/4"x1/8"x39-1/4" -8	63037,	432
86851960/ T-527-8A	SQUEEGEE BLADE (QBA)		527
86851970/ T-527-8B	SQUEEGEE BLADE (QBA)		527
86851980/ T-527-8C	SQUEEGEE BLADE (QBA)		527
86852000/ T-527-8E	BLADE, NEO BACKUP (QBA) 1-1/2"x1/8"x27"-		527
86852190/ T-86-4C	BLADE, NEO 2"x1/8"x68-1/4" - 16 Holes		86
86852200/ T-86-4D	BLADE, NEO 2-7/8"x1/8"x67-1/2" -15 Holes		86
86852350	BLADE, RIDGED URETHANE 1-9/16"x1/8"x27-1/		SERVOMATIC 17
86852360	BLADE, NEO 27-1/8" Long - 8 Hole		SERVOMATIC 17
86852370	BLADE, URETHANE 27-1/8" Long- 8 Holes		SERVOMATIC 17
98484810/ N-2001N-2	SQUEEGEE SET, (QBA) RIDGED URETHANE, 2001	2001 NEW	
98484820/ N-2001-4	SQUEEGEE SET (QBA)		2001 OLD
98484830/ N-27-4	SQUEEGEE SET(QBA)		SPEED SCRUB 2700
98484840/ N-33-4	SQUEEGEE SET (QBA)		SPEED SCRUB 3300
98484870/ N-2401N-2	SQUEEGEE SET, (QBA) RIDGED URETHANE, 2401	SPEED SCRUB 2401	

Squeegees



Tennant-Nobles (con't)

GRACO#/Old Graco#	Material Description	Compatible OEM Part Number	Fits Machines
98484880/ N-3301N-2	SQUEEGEE SET, (QBA) RIDGED URETHANE, 3301		SPEED SCRUB 3301
98484890/ N-5300-3	SQUEEGEE BLADE SET (QBA)		5300
98484900/ N-2000-2	SQUEEGEE SET (QBA)		SS2000
98485150/ T-5728-2	SQUEEGEE SET 28" (QBA)		5680-28"
98485150/ T-5728-2	SQUEEGEE SET 28" (QBA)		5680-28"
98485160/ T-5732-2	SQUEEGEE SET 32" (RED) (QBA)		5680-32"
98485160/ Graco T-5732-2	SQUEEGEE SET 32" (RED) (QBA)		5700-32"
98485280/ T-2001XR-2	SQUEEGEE SET, RED (QBA)		5200
98485280/ T-2001XR-2	SQUEEGEE SET, RED (QBA)		SPEED SCRUB 2001
98485290/ T-7128-2	SQUEEGEE SET FOR T-7100 28" (QBA) (RED)		7080
98485290/ T-7128-2	SQUEEGEE SET FOR T-7100 28" (QBA) (RED)		7100
98485290/ T-7128-2	SQUEEGEE SET FOR T-7100 28" (QBA) (RED)		EZ RIDER HP
98485290/ T-7128-2	SQUEEGEE SET FOR T-7100 28" (QBA) (RED)		SPEED SCRUB
98485290/ T-7128-2	SQUEEGEE SET FOR T-7100 28" (QBA) (RED)		T7
98485300/ T-T3R-2	SQUEEGEE SET, RED, TENNANT T3		A5
98485300/ T-T3R-2	SQUEEGEE SET, RED, TENNANT T3		T3
98485300/ T-T3R-2	SQUEEGEE SET, RED, TENNANT T3		T5
98485510/ N-1701-4	SQUEEGEE SET FOR SS1701 (QBA)		SPEED SCRUB 17-20"
98485520/ N-2700-2	SQUEEGEE SET (QBA)		SS2700
98485550/ N-3301R-2	SQUEEGEE SET NOBLES 3301 (QBA) RED RED (XR)		SPEED SCRUB 2301
98485560/ N-5100-2	SQUEEGEE SET, GUM RBR (QBA) [5100]		5100
98485590/ N-5100R-2	SQUEEGEE SET, (QBA) RED RED [5100]		5100
98485690/ T-432-3	SQUEEGEE SET		432
98485980/ N-20-4	SQUEEGEE SET (QBA)		SS2000

Squeegees

Tornado

GRACO#/Old Graco#	Material Description	Compatible OEM Part Number	Fits Machines
86827560/ B-9400-2B	BLADE, TAN GUM (QBA) 1-3/4"x1/4"x34" - 1	10470	9400
86827550/ B-9400-2A	BLADE, TAN GUM (QBA) 2-5/8"x1/4"x39" - 1	10471	9400
86827440/ B-9200-2B	BLADE, GUM (QBA) 1-7/8"x1/4"x21" - 8 Holes	13386	9200
86827430/ B-9200-2A	BLADE, GUM (QBA) 1-7/8"x1/4"x21" - 8 Hole	13387	9200
86827590/ B-9420-2B	BLADE, TAN GUM (QBA) 2-5/8"x3/16"x39-1/2"	15652	9420
86827580/ B-9420-2A	BLADE, TAN GUM (QBA) 1-3/4"x1/4"x35-1/2"	15654	9400
86827650/ B-9945-2B	BLADE, TAN GUM (QBA) 1-3/4"x1/4"x42" - 1	16259	9945
86827640/ B-9945-2A	BLADE, TAN GUM (QBA) 2-5/8"x3/16"x45-1/2"	16260	9945
86827490/ B-9320-2A	BLADE, TAN GUM (QBA) 1-3/4"x1/4"x29-1/2"	16685	9320
86827500/ B-9320-2B	BLADE, TAN GUM (QBA) 2-5/8"x3/16"x32-1/2"	16686	9320
86827520/ B-9350-2A	BLADE, TAN GUM (QBA) 1-3/4"x1/4"x34" - 1	16691	9350
86827530/ B-9350-2B	BLADE, TAN GUM (QBA) 2-5/8"x3/16"x36-3/4"	16692	9350
86622380/ B-9930-2C	SQUEEGEE FRONT	17248	9930
86827610/ B-9930-2B	BLADE, GUM (firm) (QBA) 2-5/8"x1/4"x31-7"	17249	9930
86827600/ B-9930-2A	BLADE, GUM (soft) (QBA) 2-5/8"x3/16"x31-	17261	9930
86827380/ B-3500-2B	BLADE, NEO (QBA) 2-5/8"x3/16"x19" -6 Hls	3481	350
86827370/ B-3500-2A	BLADE, NEO (QBA) 3"x3/16"x20-3/4" -6 Hol	3482	3500
86827470/ B-9300-2B	BLADE, TAN GUM (QBA) 2-5/8"x1/4"x30" - 10	3838	9300
86827460/ B-9300-2A	BLADE, TAN GUM (QBA) 1-3/4"x1/4"x25" -8	3839	9300
86827410/ B-3500M-2B	BLADE, NEO (QBA) 2"x1/4"x19" -6 Hls,3 V N	5422	3500



Tornado (con't)

GRACO#/Old Graco#	Material Description	Compatible OEM Part Number	Fits Machines
86827400/ B-3500M-2A	BLADE, NEO (QBA) 2-5/8"x1/4"21" -6 Holes	5423	3500
98485020/ B-3500M-2	SQUEEGEE SET (QBA)		3500
98485190/ B-9350-2	SQUEEGEE SET (QBA)		9350
98485200/ B-9400-2	SQUEEGEE SET (QBA)		9400
98485530/ B-9300-2	SQUEEGEE SET (QBA)		9300
98485660/ B-3500-2	SQUEEGEE SET (QBA)		3500

Windsor

GRACO#/Old Graco#	Material Description	Compatible OEM Part Number	Fits Machines
86001410/ W-C26-SL	BLADE, 13 IN LEFT	14050	Windsor Saber Cutter SC326, Windsor Saber Cutter 10052220, Windsor Saber Cutter SCC326, Windsor Saber Cutter 10052660
86855210/ W-28-2B	BLADE, GUM (QBA) 3-1/2"x3/16" (front)	73794	TRIDENT 28
86855200/ W-28-2A	Blade, GUM (QBA) 3-1/2"x1/4"x44-1/2"	73795	TRIDENT 28
86007890/ W-24-2B	BLADE, SQ. TR24 DIE CUT FRONT	73802	TRIDENT 24
86008020/ W-C26-2B	SQGE BLADE, FRONT RED 35"	73894	SABER CUTTER 26
86008170	SQUEEGEE, REAR BLADE RED	73976	SABER 24
86009240/ W-FC-S	SQUEEGEE, SIDE CYL. SCRUB	81555	FLEX CAT
86009830/ W-C32-2B	Squeegee front Blatt RED	82528	SABER CUTTER 32
86001420/ W-C32-SR	BLADE, AQ RIGHT 16 INCH	140527	SABER CUTTER 32
86001430/ W-C32-SL	BLADE, AQ LEFT 16 INCH	140528	SABER CUTTER 32
86007430/ W-C26-2A	SQUEEGEE, REAR BLADE RED	730114	SABER CUTTER 26
86007490/ W-C32-2A	SQUEEGEE, REAR BLADE, RED	730133	SABER CUTTER 32
86001580	BLADE, SQU, REAR 40.6 RED	140763	CHARIOT
86001630	BLADE, SQU, FRONT 36.7 RED GUM	140764	CHARIOT
86007260	BLADE,BLU_RIB FRT/REAR_URETHAN	730003	SCC17
86007440/ W-C264-SL	SKIRT, 26INCH, LEFT	730119,	SABER CUTTER 26
86007450/ W-C264-SR	SKIRT, 26INCH, RIGHT	730120,	SABER CUTTER 26
86001400/ W-C26-SR	BLADE, 13IN RIGHT		Windsor Saber Cutter SC264, Windsor Saber Cutter SCC264
86604850/ W-24-2A	BLADE, GUM (QBA) 3-1/2"x1/4"x36-3/4" - 8		TRIDENT 24
86855690/ W-C26-2A	SQUEEGEE BLADE, (QBA) REAR 3/16" RED		SABER CUTTER 26
98484920/ W-24-2	SQUEEGEE SET (QBA)		TRIDENT 24
98485700/ W-28-2	SQUEEGEE SET (QBA) WINDSOR TR-28		TRIDENT 28
98485710/ W-C26-2	SQUEEGEE SET, (QBA) RED		SABER CUTTER 26
98485720/ W-C32-2	SQUEEGEE SET, (QBA) RED		SABER CUTTER 32
98485780/ GW-34-2	SET,BLADES RED RED(S82528-S73900)		SABER 34



8.685-451.0

By-Pass Design, 5.7 - Type A

GRACO#/Old Graco#	Volts	Amps	Bearings #	Stages	Lamb#
8.660-119.0/ VM-1	24 DC	14.2	Dual Ball	2 Stage	116155-00
8.685-451.0/ VM-2	36 DC	10.6	Dual Ball	2 Stage	116156-00
8.685-505.0/ VM-8	120	5.5	Ball/ Sleeve	1 Stage	116325-00
8.685-502.0/ VM-7	120	7.9	Ball/ Ball	2 Stage A+	116336-01
8.660-120.0/ VM-24	36 DC	17.55	Dual Ball	3 Stage	116512-13
8.663-436.0/ VM-45	24 DC	21.1	Dual Ball	3 Stage	116514-13
8.602-675.0/ VM-46	120	8	Ball/ Sleeve	2 Stage 4.8 dia	116551-50
8.600-540.0/ VM-43	24 DC	26	Dual Ball	3 Stage	116598-13
8.685-476.0/ VM-33	120	11	Dual Ball	3 Stage A+	116764-13



8.685-482.0

Thru-Flow Design - Type B

GRACO#/Old Graco#	Volts	Amps	Bearings #	Stages	Lamb#
8.663-478.0/ VM-51	120	8.2	Dual Ball	2 Stage	116311-00
8.660-304.0/ WV-19	120	7.5	Dual Ball	2 Stage	116378-00
8.685-499.0/ VM-6	120	6.7	Ball/ Ball	1 Stage A+	116881-50
8.685-482.0/ VM-4	120	7.6	Dual Ball	2 Stage A+	116883-00
8.665-761.0/ VM-53	120	8.4	Dual Ball	1 Stage	119322-00



8.685-465.0

By-Pass Design w/Tangential Discharge 5.7- Type C

GRACO#/Old Graco#	Volts	Amps	Bearings #	Stages	Lamb#
8.685-467.0/ VM-29	24 DC	14.2	Dual Ball	2 Stage A+	116157-00
8.648-220.0/ VM-29-A	24 DC	14.2	Dual Ball	2 Stage w/1-7/8" Tube	116157-00
8.648-162.0/ VM-29B	24 DC	14.2	Dual Ball	2 Stage w/1-1/2" Tube	116157-00
8.660-740.0/ VM-20	36 DC	10.6	Dual Ball	2 Stage	116158-00
8.685-462.0/ VM-27	36 DC	10.6	Dual Ball	2 Stage A+	116158-01
8.685-442.0/ VM-13	120	8.0	Dual Ball	2 Stage A+	116392-00
8.685-465.0/ VM-280	36 DC	17.55	Dual Ball	3 Stage A+	116513-13
8.685-472.0/ VM-30	36 DC	17.55	Dual Ball	3 Stage w/1-1/2" Tube	116513-29
8.663-434.0/ VM-26	36 DC	17.55	Dual Ball	3 Stage w/1-7/8" Tube	116513-32
8.685-455.0/ VM-23	24 DC	26.0	Dual Ball	3 Stage A+	116515-13
8.685-478.0/ VM-34	24 DC	21.0	Dual Ball	3 Stage w/1-1/2" Tube A+	116515-29
8.685-458.0/ VM-25	120	10.7	Dual Ball	3 Stage A+	116565-13
8.685-474.0/ VM-31	120	10.7	Dual Ball	3 Stage w/1-1/2" Tube A+	116565-29



8.672-403.0

Thru-Flow Design - Type B

GRACO#/Old Graco#	Volts	Amps	Bearings #	Stages	Lamb#
8.685-506.0/ VM-9	120	13.0	Dual Ball	2 Stage	115530
8.672-403.0/ WV-17	120	12.8	Dual Ball	2 Stage	115962
8.662-057.0/ VM-28	120	12.7	Dual Ball	3 Stage	116118-00

A+ = Graco A+ Brand Available (see page 132)



Peripheral Air By-Pass Design, 7.5 - Type E

GRACO#/Old Graco#	Volts	Amps	Bearings #	Stages	Lamb#
8.668-622.0/ VM-10	120	11.0	Dual Ball	3 Stage	114787
8.662-320.0/ VM-42	42 DC	22.8	Dual Ball	3 Stage	115419

By-Pass Design w/Tangential Discharge, 7.2 - Type F

GRACO#/Old Graco#	Volts	Amps	Bearings #	Stages	Lamb#
8.685-440.0/ VM-11	120	13.5	Dual Ball	2 Stage	115334
8.685-441.0/ VM-12	120	12.7	Dual Ball	2 Stage	115937
8.685-446.0/ VM-14	120	13.8	Dual Ball	3 Stage	116103
8.672-404.0/ VM-47	24 DC	36.9	Dual Ball	2 Stage	117504-13
8.685-498.0/ VM-56	36 DC		Dual Ball	2 Stage	117505-13



8.660-119.0



8.685-451.0



8.667-151.0



8.685-482.0



8.685-499.0



8.685-502.0



8.685-505.0



8.685-506.0



8.668-622.0



8.685-440.0



8.685-441.0



8.685-442.0



8.685-446.0



8.672-403.0



8.660-740.0



8.683-404.0



8.685-455.0



8.660-100.0



8.685-458.0



8.663-434.0



8.685-462.0



8.662-057.0



8.685-465.0



Vacuum Motors



8.685-467.0



9.848-220.0



8.685-472.0



8.685-474.0



8.665-761.0



8.685-478.0



8.662-320.0



8.600-540.0



8.663-436.0



8.602-675.0



8.672-404.0



8.663-478.0



8.665-761.0



8.660-304.0



8.685-498.0

Motors By Ametek Lamb#

Lamb#	GRACO#/Old Graco#
114787	8.668-622.0 / VM-10
115419	8.662-320.0 / VM-42
115334	8.685-440.0 / VM-11
115530	8.685-506.0 / VM-9
115937	8.685-441.0 / VM-12
115962	8.672-403.0 / VM-17
116103	8.685-446.0 / VM-14
116118-00	8.662-057.0 / VM-28
116125-00	8.663-484.0 / VM-21
116155-00	8.660-119.0 / VM-1
116156-00	8.685-451.0 / VM-2
116157-00	8.685-467.0 / VM-29
116157-00	9.848-220.0 / VM-29-A
116158-00	8.660-740.0 / VM-20
116158-01	8.685-462.0 / VM-27
116311-01	8.685-499.0 / VM-51
119322-00	8.665-761.0 / VM-53
116325-00	8.685-505.0 / VM-8
116336-00	8.685-502.0 / VM-7
116378-00	8.660-304.0 / VM-19
116392-00	8.685-442.0 / VM-13

Lamb#	GRACO#/Old Graco#
116512-13	8.660-120.0 / VM-24
116513-13	8.685-465.0 / VM-280
116513-29	8.685-472.0 / VM-30
116513-32	8.660-120.0 / VM-26
116514-13	8.660-436.0 / VM-45
116515-13	8.663-455.0 / VM-23
116515-29	8.685-478.0 / VM-34
116551-50	8.602-675.0 / VM-46
116565-13	8.685-458.0 / VM-25
116565-29	8.685-474.0 / VM-31
116598-13	8.600-540.0 / VM-43
116764-13	8.685-476.0 / VM-33
116881-50	8.685-499.0 / VM-6
116883-50	8.667-151.0 / VM-3
116883-00	8.685-482.0 / VM-4
117504-13	8.672-404.0 / VM-47
117505-13	8.685-498.0 / VM-56
119431-13	8.660-120.0 / VM-24
119436-13	8.685-467.0 / VM-29
119434-13	8.660-740.0 / VM-20
119432-13	8.685-455.0 / VM-280
119432-29	8.672-472.0 / VM-30
119433-13	8.685-455.0 / VM-23
119433-29	8.685-478.0 / VM-34

Vacuum Motors



A+ Motors



8.685-491.0



8.625-855.0



8.620-204.0



8.685-456.0



8.625-841.0



8.625-842.0



8.601-221.0



8.600-544.0



8.600-545.0



8.625-843.0



8.625-845.0



8.600-546.0



8.625-848.0

GRACO#/Old Graco#	Volts	Amps	Bearings #	Stages	Compare to Lamb#
8.625-845.0/ VM-33 A+	120	11	Dual Ball	3 Stage	116764-13
8.625-855.0/ VM-6 A+	120	6.7	Dual Ball	1 Stage	116881-50
8.625-841.0/ VM-7 A+	120	7.9	Dual Ball	2 Stage	116336-00
8.685-481.0/ VM-4 A+	120	7.6	Dual Ball	2 Stage	116883-00
8.600-544.0/ VM-29 A+	24 DC	14.2	Dual Ball	2 Stage	116157-00
8.601-221.0/ VM-27 A+	35 DC	10.6	Dual Ball	2 Stage	116158-01
8.620-204.0/ VM-13 A+	120	8.0	Dual Ball	3 Stage	115392-00
8.625-848.0/ VM-280 A+	36 DC	17.55	Dual Ball	3 Stage	116513-13
8.600-545.0/ VM-30 A+	36 DC	17.55	Dual Ball	3 Stage	116513-29
8.685-456.0/ VM-23 A+	24 DC	26.0	Dual Ball	3 Stage	116515-13
8.600-546.0/ VM-34 A+	24 DC	21.0	Dual Ball	3 Stage	116515-29
8.625-842.0/ VM-25 A+	120	10.7	Dual Ball	3 Stage	116565-13
8.625-843.0/ VM-31 A+	120	10.7	Dual Ball	3 Stage	116565-29



Vacuum Motors

GRACO
spotlight



Ametek - Lamb Parts Reference

Ametek Motor#	Graco Motor#	Vent Fan Housing	Vent Fan	Carbon Brush	Upper Armature Bearing	Armature	Field	Lower Armature Bearing
114787	VM-10	20-3735	0-3932	35253	20-7619-2	824787	314786	60-7602
115330	VM-9	40-3770-1	3996	33415	AD-B-1	215330	316103-00	AD-B-1
115334	VM-11	40-3770-1	3996	33415	AD-B-1	215330	316103-00	AD-B-1
115419	VM-42	30-3720	0-3932	35184	70-7619-2	825419	315419	60-7642
115937	VM-12	30-4068	31325	33415	AD-B-1	215837	316103-00	AD-B-1
115962	VM-17	30-4068	31325	33415	AD-B-1	215837	316103-00	AD-B-1
116103-00	VM-14	30-4068	31325	33415	AD-B-1	216103	316103-00	AD-B-1
116118-00	VM-28	30-4068	31325	33415	AD-B-1	216103-00	316103-00	AD-B-1
116125-00	VM-21	403766-4	31297	33308	70-7613	216125-00	315625	AD-B-1
116155-00	VM-1	403766-4	31297	33392-4	AD-B-1	216155-00	315460	AD-B-1
116156-00	VM-2	403766-4	31297	33392-4	AD-B-1	216156-00	315537	AD-B-1
116157-00	VM-29	60-3727-14	03939-1	33392-4	AD-B-1	216155-00	315460	AD-B-1
116158-00	VM-20	403766-4	31297	33392-4	AD-B-1	216156-00	315537	AD-B-1
116158-01	VM-27	-	-	33392-4	AD-B-1	216156-00	315537	AD-B-1
116309-00	VM-6	30-3746	31120	33308	*	216297-00	316297-00	AD-B-1
116311-01	VM-51	30-3744	31120	33384	70-7646-2	216311-01	316304-00	AD-B-1
116325-00	VM-8	40-3754-4	1-31313	33400-7	*	216299-00	316325-00	AD-B-1
116336-00	VM-7	403766-4	31297	33308	*	216336-00	316336-00	AD-B-1
116378-00	VM-19	60-3705	31351	33326	AD-B-1	216378-00	315588	AD-B-1
116392-00	VM-13	403766-4	31297	33308	AD-B-1	216258-00	316336-00	AD-B-1
116512-13	VM-24	403766-4	03930-1	33392-5	AD-B-1	216513-00	316406-00	AD-B-1
116513-13	VM-280	403766-4	31297	33392-5	AD-B-1	216513-00	316406-00	AD-B-1
116513-29	VM-30	60-3776-4	03939-1	33392-5	AD-B-1	216513-00	316406-00	AD-B-1
116513-32	VM-26	60-3776-4	03930-1	33392-5	AD-B-1	216513-00	316406-00	AD-B-1
116515-13	VM-23	403766-4	03930-1	33392-4	AD-B-1	216514-00	316514-00	AD-B-1
116551-50	VM-46	60-3776-4	0-3930-1	33326-1	*	216551-50	315346	*
116565-13	VM-25	60-3776-4	0-3930-1	33392	AD-B-1	216565-00	315729	AD-B-1
116565-29	VM-31	60-3776-4	0-3930-1	33392	AD-B-1	216565-00	315729	AD-B-1
116598-13	VM-43	603776-4	03930-1	33462	AD-B-1	216514-00	316514-00	AD-B-1
116764-13	VM-33	403766-4	03930-1	33392	AD-B-1	216565-00	315729	AD-B-1
117504-13	VM-47	30-6786	*	35277	*	217504-00	317504-00	*
119322-00	VM-53	70-3706-4		33474	AD-B-1	219322-00	319322-05	AD-B-1
G2K 119431-13	VM-24	80-3721-4	0-3956-1	33494	AD-B-1	216513-01	319432-00	AD-B-1
G2K 119432-13	VM-280	80-3721-4	0-3956-1	33494	AD-B-1	216513-01	319432-00	AD-B-1
G2K 119432-29	VM-30	80-3721-4	0-3956-1	33494	AD-B-1	216514-01	319432-00	AD-B-1
G2K 119433-13	VM-23	80-3721-4	0-3956-1	33490-1	AD-B-1	216514-00	319433-00	AD-B-1
G2K 119436-13	VM-29	80-3721-4	0-3956-1	33490-1	AD-B-1	216155-00	319436-00	AD-B-1

Call Your Customer Service Representative for Price and Availability on Motors and Parts Not Shown

* G2K Models are updated motors from Ametek, designed to run cooler



Ametek - Lamb Parts Reference (con't)

Ametek Motor#	Fan End Bracket	1st Stage Rotating Fan	Stat. Fan w/Louvers	2nd Stage Rotating Fan	Stat. Fan w/o Louvers	3rd Stage Rotating	Fan Shell
114787	106727	31281	31175	31281	31173	31281	203734
115330	106963	31213	31360-1	31213	31360-1	31213	204429
115334	106961	31213	31360-1	31213	31360-1	31213	204429
115419	106727	31281	31229	31281	31227	31281	203734-1
115937	45931	31213(LG),31282(S)	31501-10	31213	31360	31213	304068
115962	45918	31213(LG),31282(S)	31501-10	31213	31360	31213	304068
116103-00	45931	31213(LG),31282(S)	31502-10	31120	31360 (U), 31361(L)	31120	304068
116118-00	45918	31213(LG),31282(S)	31501-10	31120	31360 (U), 31361(L)	31120	304068
116125-00	206882	31120	31293	31275	31293	31275	30377-9
116155-00	45930	31120	31257	31120	31294	31120	303779
116156-00	45930	31120	31257	31120	31294	31120	303779
116157-00	45957	31120	31278-1	31120	31278-1	31120	303779
116158-00	45957	31120	31278-1	31120	31278-1	31120	45847-
116158-01	45957	31120	*	31120	31278-1	*	14++
116309-00	45828	31120	*	*	*	*	303779
116311-01	45809	31120	*	31120	31231	*	303744
116325-00	206882	31120	*	*	*	*	303744
116336-00	206882	31120	31253	31120	*	*	403745
116378-00	206810	31351	*	31351	31352	*	303744-4
116392-00	45957	31120	*	31120	31340	*	603705
116512-13	45930	31120	31257	31120	31373	31120	603727-10
116513-13	45957	31120	*	31120	31340 (U), 31373(L)	31120	303779
116513-29	45957	31120	*	31120	31340 (U), 31373(L)	31120	303779+
116513-32	45957	31120	*	31120	31340 (U), 31373(L)	31120	45899-14+
116515-13	45957	31120	*	31120	31278-	31275	45847-14
116551-50	20-6999	31301	31463	31301	1(U),31373(L)	*	303744-14
116565-13	45957	31120	*	31120	*	31120	40-3721-4
116565-29	45957	31120	*	31120	31278-	31120	603727-10
116598-13	44339	31120	*	31120	1(U),31373(L)	31120	45899-14+
116764-13	44338	31120	*	31120	31278-	31120	603727-14
117504-13	44320	31417	31501-10	31417	1(U),31373(L)	*	603727-10
119322-00	44465-10	31468	*	*	31278-(U)	*	30-4068
119431-13	45930-1	31120-4	31257	31120	31373(I)	31120	70-3706-4
119432-13	45957-1	31120-4	31340	31120	31278-	31120	30-3744-14
119432-29	45957-1	31120-4	31340	31120	1(U),31373(L)	31120	30-3744-14
119433-13	45957-1	31120-4	31278-1	31120	*	31275	458990-14
119436-13	45957-1	31120-4	31278-1	31120	*	*	30-3744-14

Vacuum Motors

CHART KEY

L - Lower
 LG - Large
 S - Small
 U - Upper
 * - Not Applicable
 + - with 1.5" Tube
 ++ - with 1 7/8" Tube



Vacuum Parts

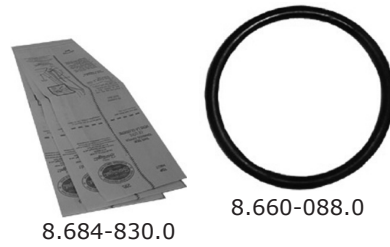

Eureka

GRACO#/Old Graco#	OEM	Description
8.663-353.0/ BRE-2	36261	Wood Brush Assy. Hex Ends
8.664-162.0/ BRE-4	52282	Brush Strip Set-Orange 12"
8.660-088.0/ BLE-3	30563A	Round Belt
8.663-351.0/ FBE-84	24716C-7	Top Fill, Red Cloth Bag with Lever Type Coupling, Slide and Spring

GRACO#/Old Graco#	OEM	Description
8.672-042.0/ FBE-84B	54582-2	Same as FBE-84 - Black
8.671-749.0/ FBE-84-Z	25544-2	Same as FBE-84 with Zipper for Disposable Bags
8.684-830.0/ PBC-300	52320	Vacuum Bag - Paper, 3/Pk (F & G Series)
8.671-143.0/ FE-1	12988-1	Lexan Fan 1400/2000 Series

Eureka/Sanitaire Vacuum Parts

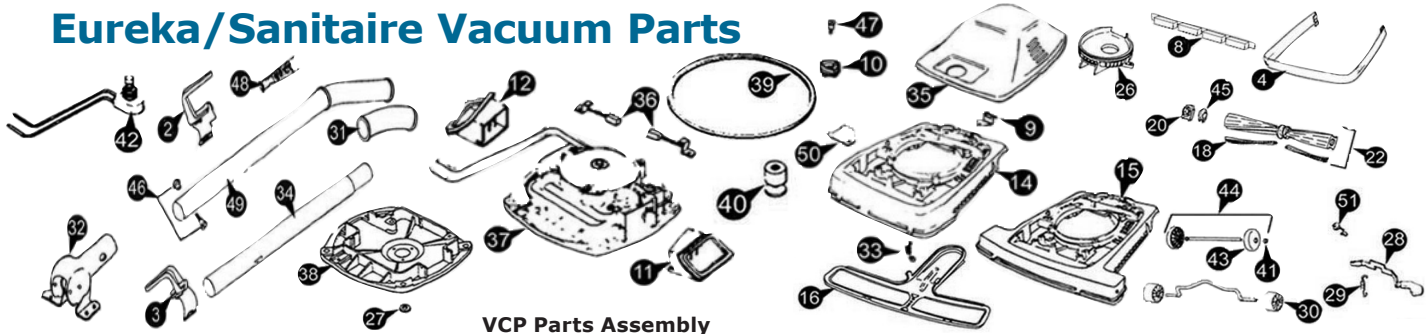

VCP Parts Assembly

Item #	GRACO#/Old Graco#	Description
2	8.664-164.0/VCP-2	Hook, Cord Upper Sanitaire
3	8.685-314.0/VCP-3	Hook, Cord Lower Sanitaire
4	8.685-325.0/VCP-4	Bumper, 12"
4	8.685-325.0/VCP-5	Bumper, 16"
8	8.685-294.0/VCP-1	Magnet, 12" w/Self Tap Screws (Blk)
8	8.685-341.0/VCP-8	Magnet 16" w/Self Tap Screws
9	8.672-396.0/VCP-9	Spring, Adaptor Retainer
10	8.685-452.0/VCP-10	Knob, Adjustment
11	8.685-296.0/VCP-11	Air Inlet Duct, Left Side
12	8.685-297.0/VCP-12	Air Inlet Duct, Right Side
14	8.664-161.0/VCP-14	Base Assembly, Red 12"
15	8.685-300.0/VCP-15	Base Assembly, Red 16"
16	8.665-948.0/VCP-16	Bottom Plate Assembly, 12" w/Gasket
16	8.672-391.0/VCP-17	Bottom Plate Assembly, 16" w/Gasket
18	8.664-162.0/VCP-18	Brush Strip Set 12"
18	8.665-682.0/VCP-19	Brush Strip Set 16"
20	8.685-306.0/VCP-20	Cap, Distributor (Rubber)
22	8.685-307.0/VCP-22	Distributor Assembly 12"
22	8.685-309.0/VCP-24	Distributor Assembly 16"
23	8.848-205.0/VCP-23	Cord Retainer Hook Set
26	8.685-310.0/VCP-26	Cover, Fan Chamber, Clear
27	8.685-311.0/VCP-27	Washer, Fan (EA) (53148)
28	8.685-312.0/VCP-28	Pedal, Foot

Item #	GRACO#/Old Graco#	Description
29	8.672-393.0/VCP-29	Spring, Foot Pedal
30	8.685-315.0/VCP-30	Wheel, Front
31	8.685-316.0/VCP-31	Handle Grip
32	8.685-317.0/VCP-32	Handle Socket Assy w/Spring
33	8.672-394.0/VCP-33	Spring, Hood
34	8.685-319.0/VCP-34	Handle Tube, Lower
35	8.664-160.0/VCP-35	Hood, Metal (No Light)
36	8.685-321.0/VCP-36	Carbon Brush Assembly
37	8.664-930.0/VCP-37	Motor, Vac High Perf, Single Speed
38	8.685-323.0/VCP-38	Motor Base Assembly
39	8.664-789.0/VCP-39	Gasket, Motor
40	8.685-326.0/VCP-40	Pulley
41	8.685-327.0/VCP-41	Push Nut
42	8.664-166.0/VCP-42	Switch, Push w/Leads
43	8.685-329.0/VCP-43	Wheel, Rear
44	8.685-330.0/VCP-44	Rear Wheel/Axle Assembly
45	8.685-331.0/VCP-45	Cap, Distributor End
46	8.667-417.0/VCP-46	Screw/Nut Set for Handle Assy
47	8.685-333.0/VCP-47	Screw, Shoulder
48	8.672-395.0/VCP-48	Spring, Strain Relief
49	8.685-335.0/VCP-49	Handle, Upper Assy w/Grip
50	8.685-337.0/VCP-50	Cover Wheel
51	8.685-338.0/VCP-51	Bushing, Strain Relief - 10 PK

Vacuum Parts



**GRACO
spotlight**



8.664-930.0

Eureka/Sanitaire Single Speed Motor

8.664-930.0 VCP-37
Replaces OEM# 54352,
ER632, 56630358, 56040A



8.663-317.0



8.682-882.0

Windsor (con't)

GRACO#/Old Graco#	OEM	Description
8.614-442.0/ WV-11	2025	Motor Pulley
8.685-631.0/ WV-16	2018	Swivel Neck Assy (14" Model Only)
8.685-622.0/ WV-10	2045	Clutch Plate
8.600-244.0/ WV-7	2046	Brush Strip (14" Model Only)
8.600-164.0/ WV-8	4028	Brush Strip (18" Model Only)
8.613-810.0/ WV-14	2047	Bearing Block - Right Hand
8.660-324.0/ WV-19	1419	Vacuum Motor
8.613-846.0/ WV-20	2241	Brush Drive Motor 14"
8.613-858.0/ WV-21	4022	Brush Drive Motor 18"
8.686-656.0/ BLW-1	4024	Versamatic Belt
8.614-160.0/ WV-22	1534	Versamatic Exhaust Filter
8.687-484.0/ WV-23	5301ER	Sensor Micro Filter
8.600-386.0/ S35213	35213	Vac Motor Gasket
8.686-397.0/ PBW-1	5300	Sensor, Versamatic Plus Filter Bags - 10 pk
8.614-137.0/ WV-25	1878	Versamatic Plus Exhaust Filter
8.614-343.0/ WV-24	1825	Versamatic Plus Motor Filter
8.613-551.0/ WV-26	23011	Cord Set 18/35SJT 40' Blue Ribbed

Hoover

GRACO#/Old Graco#	OEM	Description
8.663-317.0/ PBH-1	4010001A	Type 'A' Paper Bags, 3/Pk (Top Fill)
8.682-882.0/ BLH-2	49258	Round Belt



8.687-484.0



8.686-397.0



8.681-330.0

Windsor

GRACO#/Old Graco#	OEM	Description
8.614-457.0/ WV-17	1034	Retainer Ring - Hose
8.614-133.0/ WV-5	1043	Exhaust Filter
8.614-263.0/ WV-3	1051	Hose
8.614-333.0/ WV-6	1044	Vac Filter
8.685-624.0/ WV-12	2008	Axle Assy (14" Model Only)
8.685-647.0/ WV-9	2042	Clutch Assembly
8.613-811.0/ WV-13	2091	Bearing Block - Left Hand
8.685-644.0/ WV-4	1037	Handle
8.665-619.0/ WV-1	0517	On/Off Switch
8.681-330.0/ WV-15	2003	Paper Bag - 10 Pk
8.685-635.0/ WV-2	0582	Micro Switch
8.686-656.0/ BLW-1	4024	Belt

Vacuum Parts



8.600-634.0

American-Lincoln

GRACO#/Old Graco#	OEM	Description	Fits
8.600-634.0/ VAL-4	7-25-02030	Drain Plug (1-3/4")	All 7000's

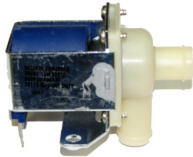

8.660-598.0

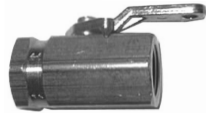

8.660-788.0



8.663-439.0

Clarke

GRACO#/Old Graco#	OEM	Description	Fits
8.662-013.0/ VA-4	899406	2 Part - 1/4" Valve	TB-16, BP-20
8.660-788.0/ VC-60	809406, 839403, 849401	3/8" Ball Valve	Vision, 17B, 20B, 21I, 26I, 26IX, 32I, 32IX, 38I, Encore S20
8.660-598.0	48703A	Solenoid Valve 36V	Clarke, Encore 28-33-38, S, L, XP, Focus 28-33-38, S, L, Xp, Focus Rider
8.660-757.0/ VC-65	18102A-7	Squeeze Valve Assembly	Leader
8.660-786.0/ VC-69	839404	Squeeze Regulator	
8.663-439.0/ VC-72	903USP, 59721A	1-1/2" Drain Valve	Clarke Extractors
8.685-290.0/ VC-72-E		Elbow for VC-72	Clarke Extractors
8.672-389.0/ VC-72-G		Gasket for VC-72	Clarke Extractors
8.663-469.0/ VC-72-N		Nut for VC-72	Clarke Extractors



8.663-439.0

Hoover

GRACO#/Old Graco#	OEM	Description	Fits
8.663-439.0/ VC-72	5918710711	1-1/2" Drain Valve	Scrub Max

Kaivac



8.848-630.0

GRACO#/Old Graco#	OEM	Description
9.848-630.0	SUBGA	Pressure Gun Assembly, White Dot
9.848-633.0	SUBGAKW	Pressure Gun Assembly, Green Dot

Advantage: Graco gun is rated at 4000 PSI & 320°F. Kaivac gun is rated at 2150 PSI & 210°F
Advantage: Graco gun has easier activating lever, for ease of operation and less operator fatigue.

Minuteman

GRACO#/Old Graco#	OEM	Description	Fits
8.660-788.0/ VC-60	809413	3/8" Ball Valve	Most Automatics
8.670-289.0	742718-1	Solenoid Valve, 36V	ES2832



8.662-615.0



8.848-073.0



8.600-624.0



8.660-191.0



8.660-120.0



8.670-289.0



8.689-624.0



8.848-072.0



8.848-096.0

Nilfisk/Advance/Kent

GRACO#/Old Graco#	OEM	Description	Fits
8.662-615.0/ VA-3	56368881	3 Way-1/4" Valve Only	Newer 24B, 26B, 260B, 24BF, 24E, 24EF
8.848-072.0/ VA-3-A	56373454	Valve Assembly w/Fittings	Same As Above
8.662-013.0/ VA-4	56368903	2 Way-1/4" Valve	17E,20E,17B,20B
8.848-073.0/ VA-4-A	56390501	Valve Assembly w/Fittings	32B, 32BD, 38B, 38BD
8.600-624.0/ VA-7	56376948	Drain Plug (1-1/4")	Trac 280,320,380
8.848-096.0/ VA-17-B	56386450	Valve Assembly w/Fittings	17B, 20B, 18B, 21B
8.660-191.0/ VTN-1	56459253	Drain Plug (1-1/2")	285LX, 325LX, 385LX
8.660-120.0/ VK-3	56027145	Valve, Solenoid	Speed Scrubs
8.670-913.0/ VK-4	56055070	Valve, Slide	Select Scrubs 27, 33, 39
8.689-624.0	9097028000	Valve, Drain	SC750/800

NSS

GRACO#/Old Graco#	OEM	Description	Fits
8.660-968.0/ VNS-1	27-140-1, 2791401	Solution Valve	Wrangler
8.660-181.0/ VTN-1	27-562-1, 2795621 37-064-1, 3790641	Drain Plug (1-1/2")	Wrangler



8.663-439.0

Steamex

GRACO#/Old Graco#	OEM	Description	Fits
8.663-439.0/ VC-72	S400P	1-1/2" Drain Valve	Pro (All), Steamlite, Omni 1500 & 2500, Triumph, Nova, Gemini
VC-72-G	S400P6	Gasket For VC-72	Same As Above
VC-72-N	S400P5, S400PB4	Nut For VC-72	Same As Above



8.660-967.0



8.671-145.0



8.662-123.0



8.848-123.0



8.664-648.0



8.664-221.0



9.484-141.0



8.663-439.0

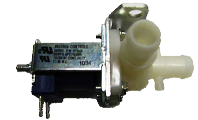

8.664-662.0

Tennant/Castex/Nobles

GRACO#/Old Graco#	OEM	Description	Fits
8.660-191.0/ VTN-1	222831	Drain Plug (1-1/2") w/2T, Gasket	5700, 5680 (Old Style)
8.662-123.0/ VTN-3	222832	Drain Plug 1"	5700, 5680 (Old Style)
8.848-123.0/ VTN-4	222113	Valve, Solenoid 36V	5700, 7200, T15, EZ Rider
8.664-221.0/ VE-1	578064	Value, Solution	515, 515SS, 8010
8.660-121.0/ VK-3	607473	Valve, Solenoid	1500, 1510, 1610
9.848-141.0/ VTN-5	374752	Valve, Water	5700, 5680
8.663-439.0/ VC-72	210230	Drain Valve (1-1/2")	Magnum, Magnum Dual Vac, Flood Pumper, Fabrimatic, Challenger
8.685-290.0/ VC-72-E	210232	Elbow For VC-72	Magnum, Magnum Dual Vac, Flood Pumper, Fabrimatic, Challenger
8.660-967.0/ VNS-1	210259, 210261	Solution Valve	1700, K1701, 2000, 2001, 2400, 2401, 2601, 2701, 2700, 2701, 3300, 3301
8.660-191.0/ VTN-1	621324	Drain Plug (1-1/2")	Most Automatics
8.671-145.0/ VTN-2	069-760-631	Water Valve 1/2"	260, 260XP, 261, 262
8.664-662.0	1016595	Solution Valve, Solenoid 24V .25-20	Tennant T2, T3, T3e, T5e, Nobles Speed Scrub 17-20", 24-32"
8.664-648.0	1008639	Drain Cap Assembly	Many Scrubbers and Extractors
8.669-441.0	603310, 612498, 613498AM	Valve, Water, Solenoid, 24V	5400w/FAST, 5520, 2001HD, 2401, 2601
8.806-890.0	630022	Valve, Water, Solenoid, 24VDC BM08/BM08	5100, 5280, 5300, BA-2000, Speed Scrub 1701 Plus



8.601-054.0



8.600-971.0

Windsor

GRACO#/Old Graco#	OEM	Description	Fits
8.601-054.0/ VWN-1	84141	Valve, Solenoid 24V	Saber 24V
8.600-971.0/ VWN-2	82312	Valve, Solenoid 36V	Saber 36V

Miscellaneous Valves

GRACO#/Old Graco#	Description	Fits
8.663-437.0/ VC-72	1-1/2" Drain Valve	Various Extractors
8.625-290.0/ VC-72-E	Elbow for VC-72	Various Extractors
8.672-387.0/ VC-72-G	Gasket for VC-72	Various Extractors
8.663-469.0/ VC-72-N	Nut for VC-72	Various Extractors
8.664-221.0/ VE-1	Solution Valve	Various Extractors Wands

Wheels



8.669-297.0

American-Lincoln

GRACO#/Old Graco#	OEM	Description	Fits
8.669-297.0/ WAL-7	7-89-08033	Caster - Squeegie	7000's
8.661-854.0/ WA-10	7-89-08023	Bumper Wheel 3.00 x .781 Black	721, 726, 730, 930, 936



8.661-873.0

Breuer-Tornado

GRACO#/Old Graco#	OEM	Description	Fits
8.661-873.0/ WA-1	14530	5 3/8" Poly Swivel Caster Green Non-Marking	9300/Mid Range, 9400/H Series, 24", 28"
8.661-631.0/ WA-1-W	14528	Wheel Only For WA-1, Green	9300/Mid Range, 9400/H Series, 24", 28"
8.661-854.0/ WA-10	10587	Bumper Wheel-3.00 x 3/4"	9300/Mid Range, 9400/H Series, 24", 28" Breuer Tornado Glazer
8.660-848.0/ WC-4	12508	4" Rubber Swivel Caster Grey	9200
8.685-613.0/ WT-1	13817, 13757	10 x 2 Poly Wheel Silver/Green Trim .75 Shaft Diameter	9300 & 9400



8.660-611.0



8.660-848.0

Clarke

GRACO#/Old Graco#	OEM	Description	Fits
8.660-331.0/ MC-29	60154A	Shaft for WC-5-VA	Vision
8.661-631.0/ WA-1-A	890554	Axle for WC-3	TB-24, TB-32, Leader Automatics
8.685-534.0/ WA-1-B	902704	Caster Bearing for WC-3	TB-24, TB-32, Leader Automatics
8.660-332.0/ WA-7	439704, 419702	Bumper Wheel-2 1/2" x 5/8" Bumper Wheel, Grey	TB-24, TB-32, Vision
8.660-644.0/ WC-2	809059	Tire Tube to Fit WC-11	TB-24, TB-32
8.660-611.0/ WC-3	899713, 899769, 899716	5" Poly Swivel Caster Assy Maroon/Red	TB-24, TB-32, Leader 2400 SII, 2400D SII, 2400HD SII, 3200 SII, Vision 21I, 26I, 26IX, 32I, 32IX, 38I, Ultra Speed 322 SII, 3220, Encore L28, S28, L33, S33, L38, S38, Fusion 20I, 20IX
8.663-713.0	50397A, 98629A	6" Wheel, Gray Rubber, 3/8" Bore	TB-24, TB-32, Leader Automatics
8.660-612.0/ WC-3-W	899714, 899765	Wheel Only for WC-3	TB-24, TB-32, Leader Automatics



Clarke

GRACO#/Old Graco#	OEM	Description	Fits
8.660-848.0/ WC-4	19603A, 59944	4" Rubber Swivel Caster Grey	18,21,BP20,LV-30, 202, 2000B
9.848-128.0/ WC-5-A	59844	Drive Wheel	TB-60,TB-80, 2400, 3200
9.848-322.0/ WC-5-V	59950A	Drive Wheel	Visions
8.660-599.0/ WC-6	899761	Guide Wheel Grey w/Green Trim	Vision 21I, 26I, 26IX, 32I, 32IX, 38I Encore S20, L20, S28, L28, S33, L33, S38, L38
8.688-749.0	50968A	Caster Assy Dual wheel	Boost 28, 32, Encores2426
9.848-093.0/ WC-18	419752	Grey Non-Marking Tire & Rim Assy. 4.1 x 3.5-6	TB-24, TB-32
8.685-567.0/ WC-23	30181A, 419752 804545	4" Wheel 4X1X1/2" Bore	Direct Speed 20

Eagle

GRACO#/Old Graco#	OEM	Description	Fits
8.606-152.0	1200	6" x 1-1/2" Gray Rubber Wheel	
8.663-703.0	1205	6" Wheel w/Bracket	

Kent

GRACO#/Old Graco#	OEM	Description	Fits
8.660-611.0/ WC-3	56055657, 56055658 56440450	5" Poly Swivel Caster	18,21,BP20,LV-30, 202, 2000B
9.848-131.0/ WK-4	56052218	6" Wheel Black 1" width, 3/4" shaft, 1/2" hole dia.	KF-2000E

Mercury

GRACO#/Old Graco#	OEM	Description	Fits
8.661-727.0/ WM-1	M-250	6" Diameter Wheel Black	Burnishers



8.660-872.0

Minuteman

GRACO#/Old Graco#	OEM	Description	Fits
8.660-872.0/ WA-3	762333	Swivel Caster w/ Bolted Flange 3 1/2" x 1 1/4" Grey	M2200, M-24, M-32,200
8.660-611.0/ WC-3	827110	5" Poly Swivel Caster	200
8.660-874.0/ WA-5	762332	8 x 2 Rubber Wheel w/ 3/4 Bearing	260
8.661-854.0/ WA-10	808829	Bumper Wheel Black	260, 265, 320
8.664-026.0	430325	Caster 2.5" Dia.	

Wheels



8.661-873.0



8.660-940.0



8.660-873.0



8.662-656.0



8.805-428.0



8.805-428.0

Nilfisk/Advance

GRACO#/Old Graco#	OEM	Description	Fits
8.661-873.0 / WA-1	56365555, 56365629	5-3/8" Poly Swivel Caster Green	18,21,24,26,32,38,260B
8.661-631.0 / WA-1-A	56365645	Axle for WA-1	18,21,24,26,32,38,260B
8.685-534.0 / WA-1-B	56365718	Bearing for WA-1	18,21,24,26,32,38,260B
8.685-536.0 / WA-1-SG	56365734	.51 x .76 x 2.4 Bushing for WA-1	18,21,24,26,32,38,260B
8.661-631.0 / WA-1-W	56365742	Poly Wheel w/Bearings for WA-1 Green	18,21,24,26,32,38,260B
8.660-873.0 / WA-2	56391110	Wheel 6 x 1-1/2	Whirlamatic 2500 & 20UHSB
8.660-872.0 / WA-3	56206725	Swivel Caster w/Bolted Flange 3-1/2x1-1/4 Grey	20B, 134B
9.848-133.0 / WA-4	56365610	8 x 2 Rubber Wheel w/5/8 Bearing	17,20
8.660-874.0 / WA-5	56362336	8 x 2 Rubber Wheel w/3/4 Bearing	18,21
8.662-656.0 / WA-6-2	56395222	8x2 Poly Wheel w/Bearing-2.5" Hub	32,38 Newer
9.848-090.0 / WA-6-C	56377945, 56377961	8 x 1-5/8 Poly Wheel w/Groove and 3/4 Bearing (2.5" Hub) Grey/Green Trim	24,26,32,38
8.660-332.0 / WA-7	56363855	Bumper Wheel 2-1/2 x 3/4 Grey	18,20B,21,24,26,32,38
8.661-830.0 / WA-8	56362352	8 x 1-5/8 Poly Wheel w/Keyway (2" Hub) Silver	32BD, 38BD
8.662-018.0 / WA-9-2	56395233	8 x 2 Poly Wheel w/Keyway (2.5" Hub)	17,20
8.661-854.0 / WA-10	56324350, 56324499	Bumper Wheel 3.00 x .781 Black	7000's
8.671-766.0 / WA-11	56228102	Wheel 4" x .875 Black	Trac 380BD, Whirlamatic 1100E
8.662-020.0 / WA-12	56185518	5" Caster Wheel Swivel, Red	Trac 280,320,380
8.663-468.0 / WA-28	56470582, 56440150	Wheel 5.00 x 1.250 Hard Black	Matador, Pacemaker
8.662-030.0 / WA-91	56161691, 56230448	Wheel 5.00 x .937 Hard plastic Grey	Carpetron 18, 28
8.660-940.0 / WA-95	56327530	Wheel 4.00 x .968, Black w/Silver center	Twin 20, 16
8.685-592.0 / WK-6	56049376	Caster Wheel	KF2001, 2002, 2500, KA201, 262
8.601-102.0 / WN-4	56630450	Wheel, Bumper Rubber w/Spanner Black	Select Vac 16HP
8.663-702.0	56649823	Wheel w/ Bracket	Whirlamatic 27, Propane
8.806-152.0		Wheel only for 8.663-702.0	Whirlamatic 27, Propane
8.805-428.0	56397016	Swivel Caster 3.5" Poly	Convertamax 20, Convertamax 26
9.848-678.0	56412124	Kit Wheel w/Hardware	Adhancer, Adgressor

Wheels

GRACO
spotlight



9.848-605.0



8.664-275.0

Tire Assemblies

8.664-275.0 Tire Assy, Gray, Pneumatic,
410/3.5-06 3.5BC/3BOLT
Replaces OEM #'S 78572, 61597, 59969A

9.848-605.0 Tire Assy, Gray, Foam,
410/3.5-06, 3.5Bc/3Bolt
Replaces OEM #'S 61598, 374044, 381918, 59955A



NSS

GRACO#/Old Graco#	OEM	Description	Fits
8.660-874.0/ WA-5	8490511, 44-051-1	8 x 2 Rubber Wheel w/ 3/4 Bearing	Charger 2000
8.661-873.0/ WA-1	4490501, 44-050-1	Caster Assembly, Green	Wrangler
8.660-187.0/ WNS-1	0290416, 02-049-1	Caster Wheel- 3"x 5/8", Black	Model M-1
8.660-215.0/ WNS-2	8096741, 30-674-1	Bumper Wheel 2"X7/8"	Wrangler

Pioneer Eclipse

GRACO#/Old Graco#	OEM	Description	Fits
8.663-441.0/ PB-5	MP9450	5" Wheel w/Bracket, Blue	Propane Buffers
8.689-939.0	MP9420	Wheel only for 8.660-874.0 (PB-5)	
9.848-063.0/ PB-6		5" Heavy Duty Wheel Only	Propane Buffers
8.663-712.0/ PB-7		6" Heavy Duty Wheel Only, Black Trim	Propane Buffers
8.660-948.0/ PB-39		3" Swivel Caster Grey	Propane Buffers
8.600-231.0/ WN-1	MX-0026	4" Caster Assembly	Burnishers

Tennant/Castex/Nobles

GRACO#/Old Graco#	OEM	Description	Fits
8.672-040.0/ F759203	61596	Tire, Grey Non-Marking	5700
8.6660-611.0/ WC-3	18643, 63312	5" Poly Swivel Caster Assy	432
8.660-117.0/ WTN-1	63268-1, 069762407	Non-Marking Tire Only (4 Ply) 4.10/3.50 x 5, Grey	432, 261
8.660-101.0/ WTN-2	63268-2	Inner Tube To Fit WTN-1	432, 261
8.660-215.0/ WTN-6	222403	Bumper Wheel, Black	5700
8.670-977.0/ WN-6	612056, 1049048 630002	Caster, Swivel 4.0Dx1.30Wx5.28H	1500, 1510, 1520, 1530, 5280, 5500, 5520, 2401, 2601
9.848-605.0/ WTN-7	61598, 374044	Tire Assy Grey Foam Filled	5680, 5700
8.664-275.0/ WTN-8	61597	Tire Assy Grey Pneumatic	5700
8.661-854.0/ WA-10	222066	Bumper Wheel	5700
8.666-147.0	630477	Wheel, PYU, 02.0D 0.38W, Gray	Many Tennant & Nobles Applications
8.673-119.0	1006343	Caster, Swivel, 50MMD, M10 X 30, Clr Pl	Speed Scrub (17-20"), A5, Sped Scrub (24-32"), T3, T3/T3+, T3e, T5, T5e, 5400 w/FaST, 5500(XR Squeegee), Speed Scrub 2001HD (XR Squeegee), Speed Scrub 2401 (XR Squeegee), Speed Scrub 2601 w/FaST (XR Squeegee)
8.674-349.0	1019008, 1026345	Caster, Swivel, 80MMD, M12 X 25	T3, SS17-20
8.672-496.0*	103058	Wheel, Drive 8"	5540, 5560, 2701, 3300, 3301

*We also stock the following used with **8.672-496.0**: 8.662-637.0, Bearing 6205-2Rs, OEM: 140124;
8.666-909.0, Shaft, Drive Wheel OEM: 230205; 8.688-505.0, Sprocket, Drive Wheel, OEM: 240070;
8.686-094.0, 5/16" Lock Washer, OEM: 140015; 8.869-065.0, Screw, 5/16-18X3/4, OEM: 14022



Introduction	1	Brushes	75
Terms and Conditions	2	Graco Manufacturing Helps You Save Time and Money with Our Industrial Brush Line.	
OEM	3-67	Brushes	76
Aftermarket Parts & Accessories	68	Side Sweeping Brushes	
Batteries	69	Extending Side Brush Life & Maximizing Performance	
Flooded Battery		Cylindrical Scrub Brushes/Rotary Scrub Brushes	
Sealed Lead AC ID (AGM) Battery		Extending Cylindrical Brush Life & Maximizing Performance	
Batteries: Cables & Accessories	70	Short-Trim Pad Drivers	
Battery Cable - Type A		Brushes	77-101
Battery Cable - Type B		Advance American-Lincoln	77-80
Battery Cable - Type C		Advance American-Lincoln by Machine	80-87
Battery Terminals		Tennant - Nobles	88-89
Bulk Battery Cables		Tennant - Nobles by Machine	89-99
Battery Accessories		Brushes	100
Bearings	71	Brush Rollers & Strips	
American-Lincoln		Center Pad Holder Devices	
Breuer-Tornado		Brushes	101
Castex/Nobles		Clutch Plates & Brush Drive Devices	
Clarke		Tennant - Nobles	
Minuteman		Chains	102
Nilfisk/Advance		American-Lincoln	
NSS		Castex/Nobles	
Tennant		Clarke	
Bearing Cross Reference		Hoover	
Belts: Types and Cross Reference	72	Kent	
Belt Types		Nilfisk/Advance	
POLY V-BELT		NSS	
TIMING		Chargers	103-108
ROUND		Lester Battery Chargers Semi-Automatic Timer	
V-BELT		Lester Battery Chargers Automatic Timer	
Belts	73	Motor Appliance Chargers Automatic Timer	
Poly V Belts - Clarke		Dayton Battery ChargerManual	
Poly V Belts - Minuteman		Delta-Q	
Poly V Belts - Nilfisk/Advance		Chargers: Accessories	104
Poly V Belts - Tennant		Plugs & Plug Housings	
IPC - Eagle		Special Cord Assemblies	
Round Belts - Clarke		Charger Ordering Guide	105-106
Round Belts - Nilfisk/Advance		Chargers: Parts Reference	107
Round Belts - Miscellaneous		Charger Plug Handles	
Timing Belts - Breuer-Tornado		Lester	
Timing Belts - Castex/Nobles		M.A.C.	
Belts: Types and Cross Reference	74	Chargers: Parts Reference	108
Timing Belts - Clarke		Lester	
Timing Belts - Nilfisk/Advance		M.A.C.	
Timing Belts - Miscellaneous			
V Belts - American-Lincoln			
V Belts - Clarke			
V Belts - Nilfisk/Advance			
V Belts - Miscellaneous			
MISC			



Cords: Cords and Connectors 109-110

Cords 109

- 25 Feet
- 40 Feet
- 50 Feet
- 75 Feet
- 100 Feet
- Armored Construction
- Nylon Construction - Standard 3 Prong

Cords: Connectors and Accessories 110

- Nylon Construction - Twist Lock 3 Prong
- Cord Accessories
- High Visibility Cords

Drive Units 111-112

Drive Units 111

- Clarke - Boost Isolator Mount Kits
- Clarke - Drive Couplings
- Clarke - Drive Sprockets
- Clarke - Gear Unit
- Clarke - Miscellaneous
- Misc - Flange, Drive Hub
- Misc - Pulley, Idler 4"

Drive Units 112

- Misc - Bearing/Shaft Assy Front Housing
- Tennant - Sprocket 40A39 x 1.75
- Tennant - Shaft, Drive Wheel
- Tennant - Sprocket 1/4" Keyway, 3/4" Tooth

Electrical Parts 113-122

Electrical Parts 113

- Capacitors
- Speed Controller
- Circuit Breakers - Style A

Circuit Breakers - Style B

Electrical Parts 114

- Electrical Plugs & Connectors
- Fuses
- Meters

Electrical Parts 115

- Rectifiers
- Cable Ties
- Potentiometers
- Motor Carbon Brushes

Electrical Parts 116

- Motor Carbon Brushes* (continued)
- Solenoids

Electrical Parts 117

- Switches

Electrical Parts 118

- Switches

Electrical Parts 119

- Kent
- Minuteman
- Nilfisk/Advance

Electrical Parts 120

- Nilfisk/Advance (con't)
- NSS

Electrical Parts 121

- Pullman-Holt
- Steamex
- Tennant
- Windsor

Electrical Parts 122

- Terminals
- Wing Nuts

Equipment 123

- Graco Legacy Air Mover - LAM3

Shop Supplies 124-125

Filters/Stainers/Floats 124

- Breuer-Tornado
- Clarke
- Eureka
- Kent
- Minuteman
- Nilfisk/Advance/Clarke
- NSS
- Pro-Team

Filters/Stainers/Floats & Gaskets 125

- Tennant/Nobles/Castex
- Windsor

Gaskets 125 - 127

- American-Lincoln
- Aztec

Gaskets 126

- Breuer-Tornado
- Clarke
- Minuteman
- Nilfisk/Advance

Gaskets 127

- Factory Cat
- NSS
- Pro-Team
- Steamex
- Tennant/Castex/Nobles
- Bulk Strip Gasket w/ Adhesive

Hoses 128 - 131

Hoses 128

- Vacuum Hose Cuffs & Connectors



Hoses / Specialty Hoses 129	Pumps 139 - 140
Nylon Braided	
Low Pressure	
Steam Extraction	
Bulk Vacuum Hoses Heavy Duty	
Bulk Vacuum Hoses Medium Duty	
Wire Reinforced	
Specialty Hoses 129	Pumps 139
Breuer-Tornado	Flojet
	Little Giant
	Shurflo
Specialty Hoses 130	Pumps 140
Clarke	Barbs
Hoover	Elbows
Minuteman	Filters
Nilfisk/Advance	Nipples
NSS	Tees
Specialty Hoses/Drain Plugs/Caps 131	Shop Supplies 141 - 143
Tennant/Nobles/Castex	
Viper	
Drain Plugs	
Universal Hose Assembly	
Windsor	
Motors 132-133	Shop Supplies 141
	Cable Ties - Nylon, 100/pack
Motors - Drive/Brush 132	Spray Lubricants
Clarke	Tape
Nilfisk/Advance	General Purpose Primary Wire
Graco A + Motors	Wire Nuts - 100/pack
	Miscellaneous
Motors 133	Shop Supplies 142
Miscellaneous	Ring Terminals - Insulated
	Ring Terminals - Non-Insulated
Engine Parts 134 - 138	Miscellaneous Terminals
	Terminal Kit
Engine Parts 134	Shop Supplies 143
Briggs & Stratton	Kits
Honda	
Kawasaki 17 HP	
Propane Burnisher Parts 135	Solution Tanks 144
Kohler	
Onan - to Fit E124V-L 14HPT	
Onan - to Fit F248V-L 20HP	
Propane Burnisher Parts 136	Popular Universal Floor Machine Tank 144
Robin Engine Parts	
Belts and Pulleys	
Propane Fuel Parts	
Propane Burnisher Parts 137	Squeegees 145-174
Miscellaneous	Advance 145-153
Pad Driver Assemblies & Parts	American Lincoln 153-154
	Betco..... 154
Propane Burnisher Parts 138	Clarke..... 154-157
Wheels	Eagle Power 157
Accessories	Factory Cat 157-158
Starter Solenoids - 12 Volt	GRACO 158
	Hoover 158
	Kent 158-160
	Minuteman..... 160-161
	NSS 161-162
	Pullman-Holt..... 162
	Star 162-163
	Taski 163
	Tennant-Nobles 164-173
	Tornado..... 173-174
	Windsor 174



Vacuum Motors	175-180	Valves	184
Vacuum Motors	175	Minuteman	
By-Pass Design, 5.7 - Type A		Nilfisk/Advance/Kent	
Thru-Flow Design - Type B		NSS	
By-Pass Design w/ Tangential Discharge 5.7		Steamex	
Type C		Valves	185
Peripheral Air By-Pass Design, 7.2 - Type D		Tennant/Castex/Nobles	
Vacuum Motors	176	Windsor	
Peripheral Air By-Pass Design, 7.5 - Type E		Miscellaneous Valves	
By-Pass Design w/ Tangential Discharge 7.2		Wheels	186
Type F		American-Lincoln	
Vacuum Motors	177	Breuer-Tornado	
Motors by Ametek Lamb #		Clarke	
Vacuum Motors	178	Wheels	187
Graco Spot Light - A+ Motors		Clarke	
Vacuum Motors	179-180	Eagle	
Ametek Lamb Parts Reference		Kent	
Vacuum Parts	181-182	Mercury	
Vacuum Parts	182	Minuteman	
Eureka/Sanitaire Single Speed Motor		Wheels	188
Hoover		Nilfisk/Advance	
Windsor		Tire Assemblies	
Valves	183 - 185	Wheels	189
Valves	183	NSS	
American-Lincoln		Pioneer Eclipse	
Clarke		Tennant/Castex/Nobles	
Hoover			
Kaivac			





